

Assembly & User Instructions

Mirage 38,200Btu

Heat Focusing Patio Heater

These instructions are for your safety. Please read them thoroughly before use and retain them for future reference.



DANGER:

If you smell gas:

1. Shut off gas to the appliance.
2. Extinguish any open flame.
3. If odor continues, keep away from the appliance and immediately call your gas supplier or fire department.



WARNING:

Do not store or use gasoline or other flammable vapors and liquids in the vicinity of this or any other appliance. An LP-cylinder not connected for use shall not be stored in the vicinity of any other appliance.



WARNING:

For Outdoor Use Only.









WARNING:



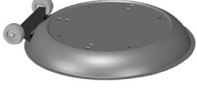

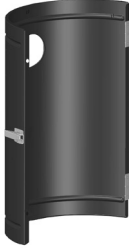

Improper installation, adjustment, alteration, service or maintenance can cause injury or property damage. Read the installation, operating and maintenance instructions thoroughly before installing or servicing this equipment.

We provide a **Customer Support Service**. If you have any queries please contact us on info@uigroup.ie or tel. (678) 534 2876 or visit our website www.uigroup.ie



You will find product assembly/demonstration videos on our website:
www.uigroup.ie/product-demonstrationstutorial-videos

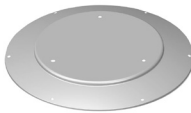



Parts Supplied

Ref	Description	Illustration	Qty
1	Base		1
2	Cylinder Chamber Supports		3
3	Cylinder Chamber Door		1
4	Cylinder Chamber Wall		1
5	Cylinder Chamber Top		1
6	Reflector Handle		1

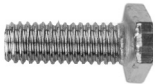
Ref	Description	Illustration	Qty
7	Lower Support Pole		1
8	Upper Support Pole		1
9	Lantern		1
10	Parasol Side Panels		6
11	Parasol Top Panel		1
12	Regulator		1

Fixings Supplied

Ref	Description	Illustration	Qty
A	1/4" Dome Head Bolt		27
B	1/4" Nut		33
C	1/4" Hex Bolt		19

Ref	Description	Illustration	Qty
D	1/4" Washer		7
E	5/16" Washer		3
F	5/16" Bolt		3
G	1/4" Spring Washer		7

Fixings are shown at actual size.

Before You Start

- Check the contents of the box and make sure you have all the parts and fittings listed. If not, contact the factory by email: info@uigroup.ie or the Helpline (678) 534 2876
- When you are ready to start, make sure that you have the right tools at hand, plenty of space and a clean dry area for assembly.

Assembly

- Please lay out all nuts and bolts and check lengths before assembly. It is recommended that the carton is cut open and spread out on the floor and used as a protective surface during assembly. Refer to the assembly diagrams as necessary.
- Important - while every precaution has been made in the manufacture of this product, care must be taken during assembly in case sharp edges are present.

Assembly Step 1

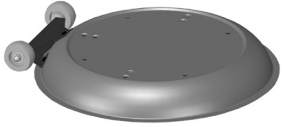

Base



Cylinder Chamber
Supports (A,B,C)

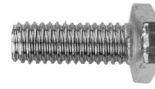

1/4"
Hex Bolt (C)

Fix the cylinder chamber supports (A,B,C) to corresponding location on the base with 6 of the 1/4" hex bolts (Ref. C). Finger tighten only.

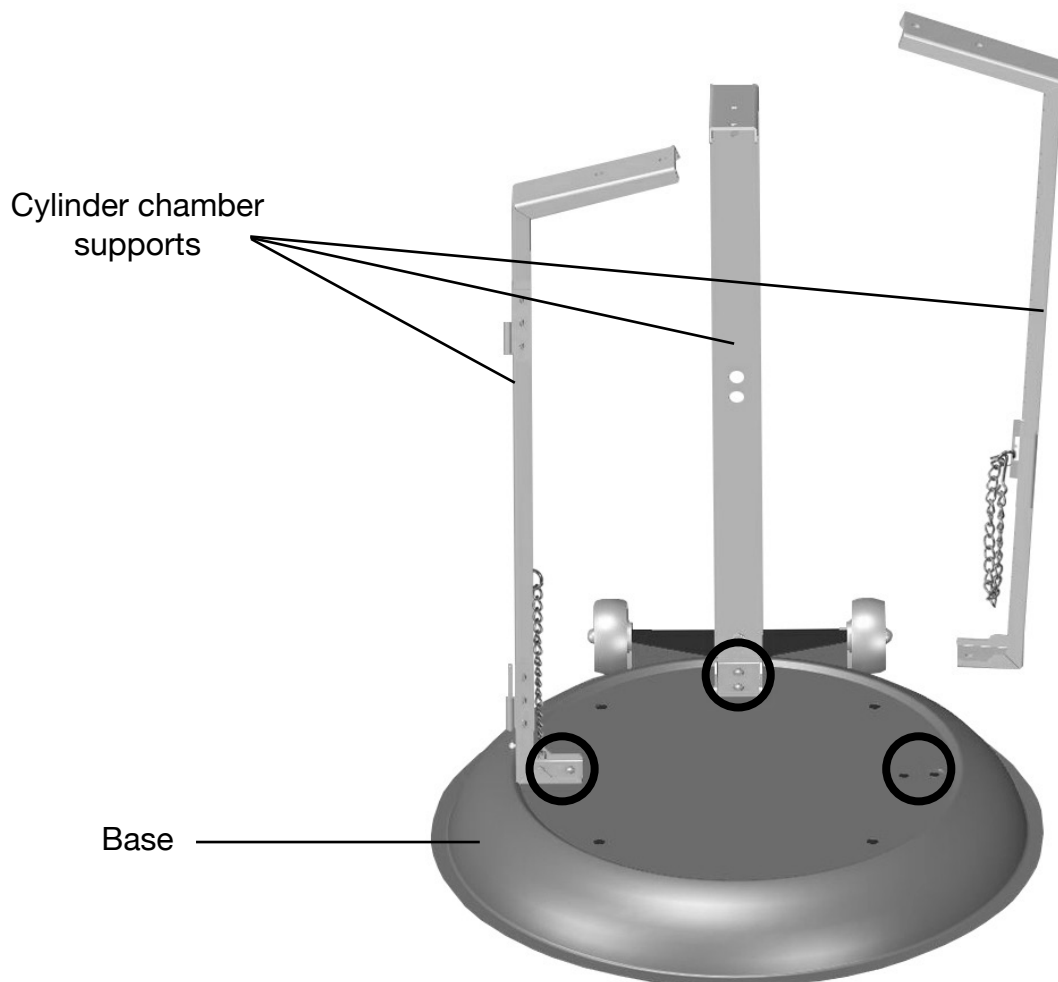

Assembly Step 2



Lower
Support Pole



1/4" Nut (B)

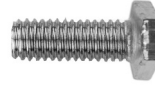

1/4"
Hex Bolt (C)

Fix lower support pole to cylinder chamber supports as shown using 6 of the 1/4" hex bolts (Ref. C) and 6 of the 1/4" nuts (Ref. B). Finger tighten only.

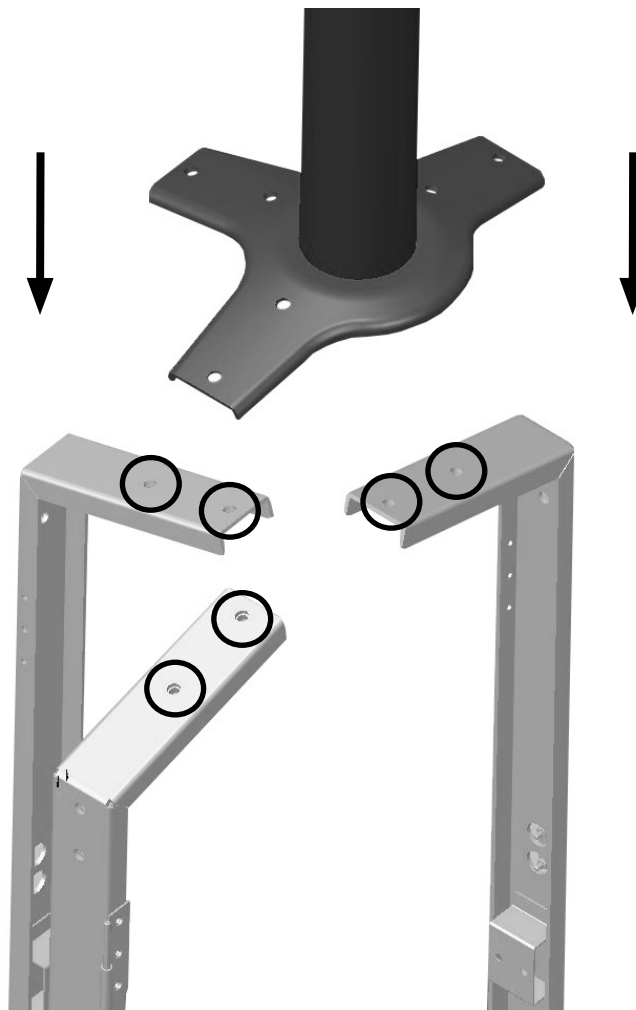

Assembly Step 3



Cylinder
Chamber Wall



1/4" Dome
Head Bolt (A)



1/4" Nut
(B)

Fit the cylinder chamber wall to the cylinder chamber supports using 6 of the 1/4" dome head bolts (Ref. A) and 6 of the 1/4" nuts (Ref. B). Finger tighten only.



Assembly Step 4



Cylinder
Chamber door

Hang door on hinges. Ensure correct alignment and tighten all bolts securely.



Assembly Step 5



Cylinder
Chamber Top



1/4" Dome Head
Bolt (A)



1/4" Nut
(B)

Fit cylinder chamber top onto cylinder chamber support legs using 3 of the 1/4" dome head bolts (Ref. A) and 3 of the 1/4" nuts (Ref. B).

Cylinder
Chamber Top

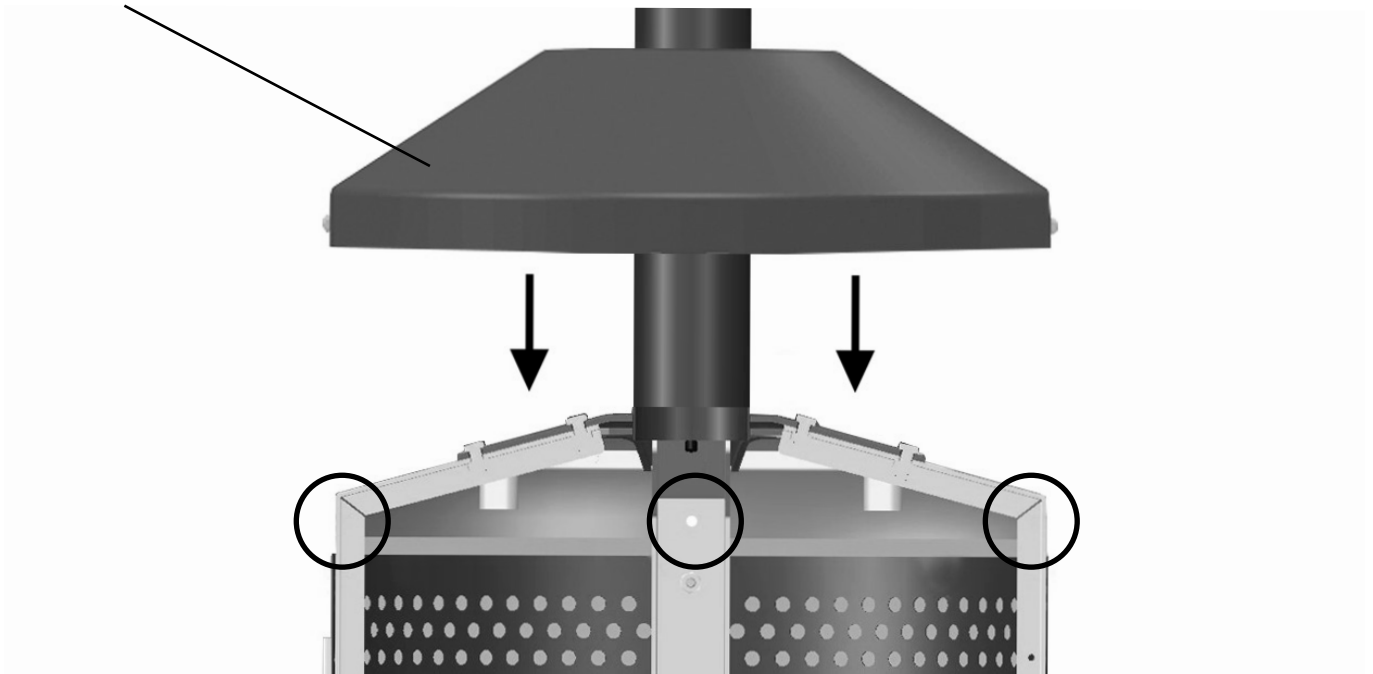

Assembly Step 6



1/4" Hex Bolt (C)



1/4" Washer (D)



1/4" Spring Washer (G)

Fit upper support pole to lower support pole using 3 of the 1/4" hex bolts (Ref.C) and spring washers (Ref.G) and washers (Ref.D).

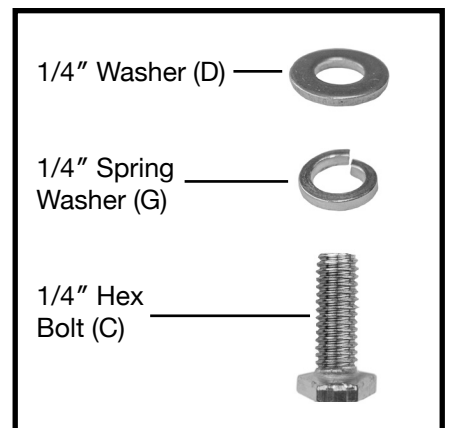
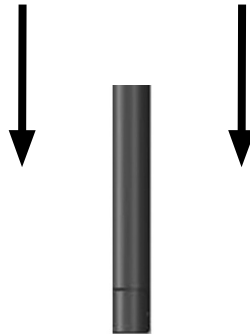

Assembly Step 7



1/4" Hex Bolt (C)



1/4" Washer (D)



1/4" Spring Washer (G)



Battery

Feed the lantern hose down the support pole and secure lantern to support pole using 4 of the 1/4" Hex Bolts (Ref. C) and spring washers (Ref. G) and washers (Ref. D).

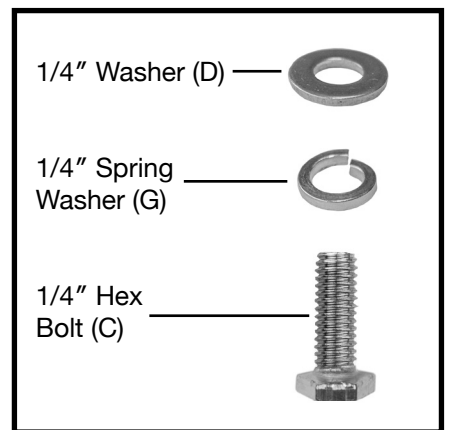
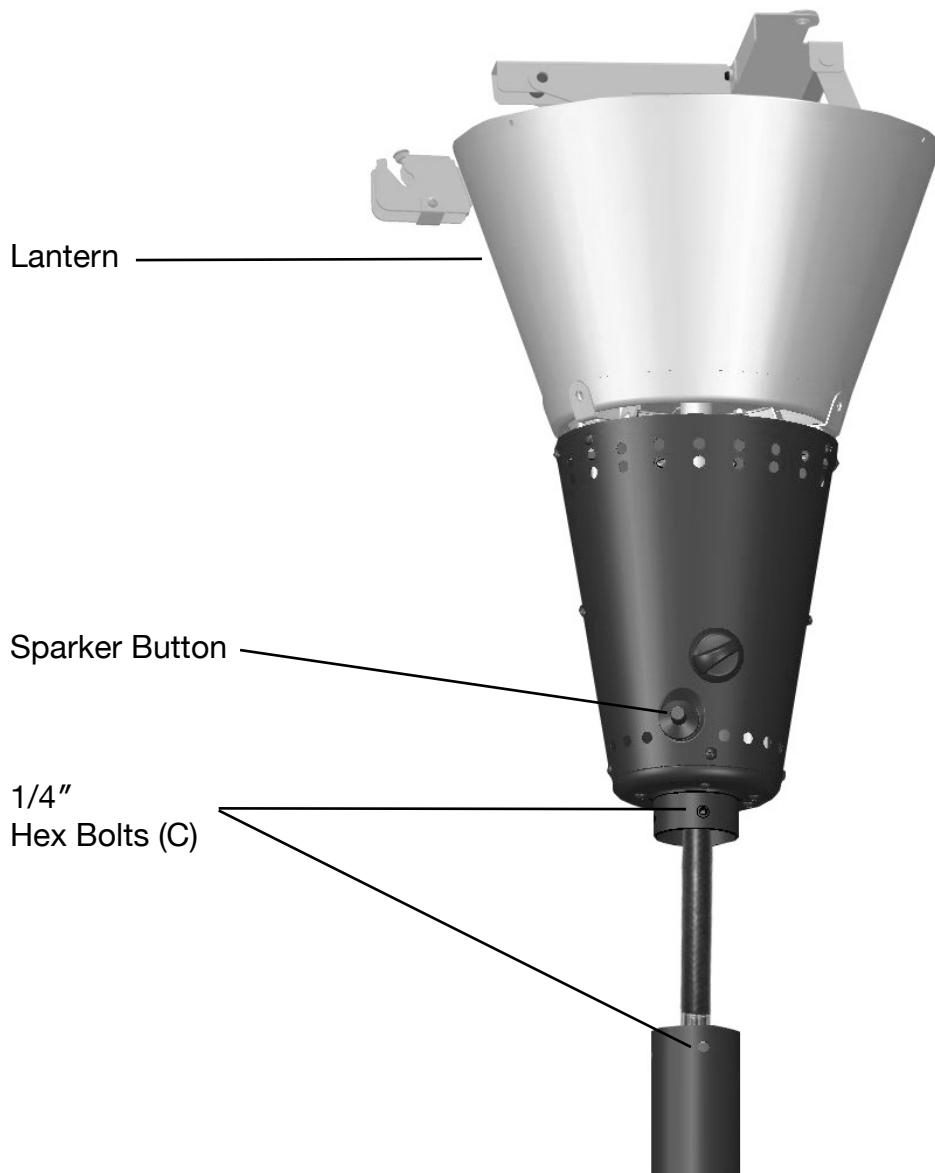

Unscrew sparker button and insert battery, positive side facing outwards.

Assembly Step 8



Regulator

Connect the lantern hose to the regulator hose and secure tightly with adjustable wrenches. Then attach the regulator to the cylinder, turn clockwise to tighten it securely. Place cylinder in position as shown.

Note: The cylinder must be positioned as shown in the patio heater cylinder chamber to provide vapor withdrawal.

Check for Leaks

Your patio heater has been checked at all factory connections for leakage. To check the connection at the gas hose/regulator/cylinder

1. Make leakage solution by mixing 50% water with 50% liquid dish soap.
2. Brush several drops of the solution onto the gas hose/regulator/cylinder and hose connection.
3. Turn on the gas cylinder valve. Inspect the connections and look for bubbles.
4. If no bubbles appear the connection is safe.
5. If bubbles appear there is leakage, loosen and re-tighten this connection. If it still leaks, please contact customer service on info@uigroup.ie or (678) 534 2876.

First, connect hose to regulator securely using adjustable wrenches

Second, screw regulator onto gas cylinder

Position gas cylinder inside cylinder chamber as shown securing with chain.

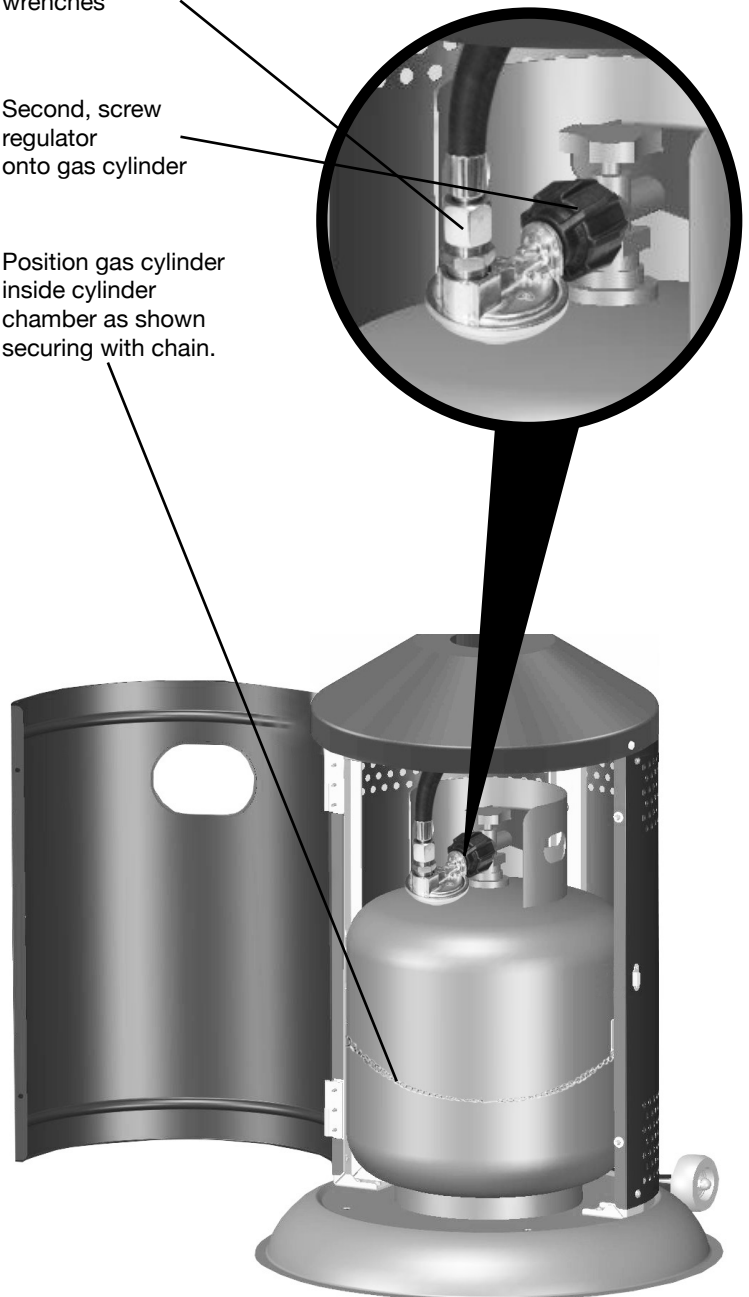

Points for leak testing

Regulator / Cylinder

Hose / Regulator

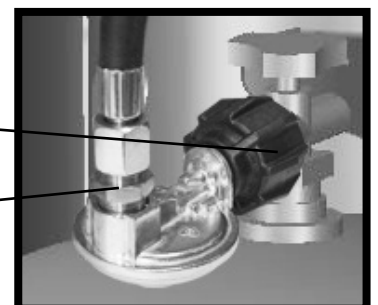

Assembly Step 9



Fitting reflector handle

Using the pre-fitted R-clip and pin, secure the reflector handle to the bracket as shown.

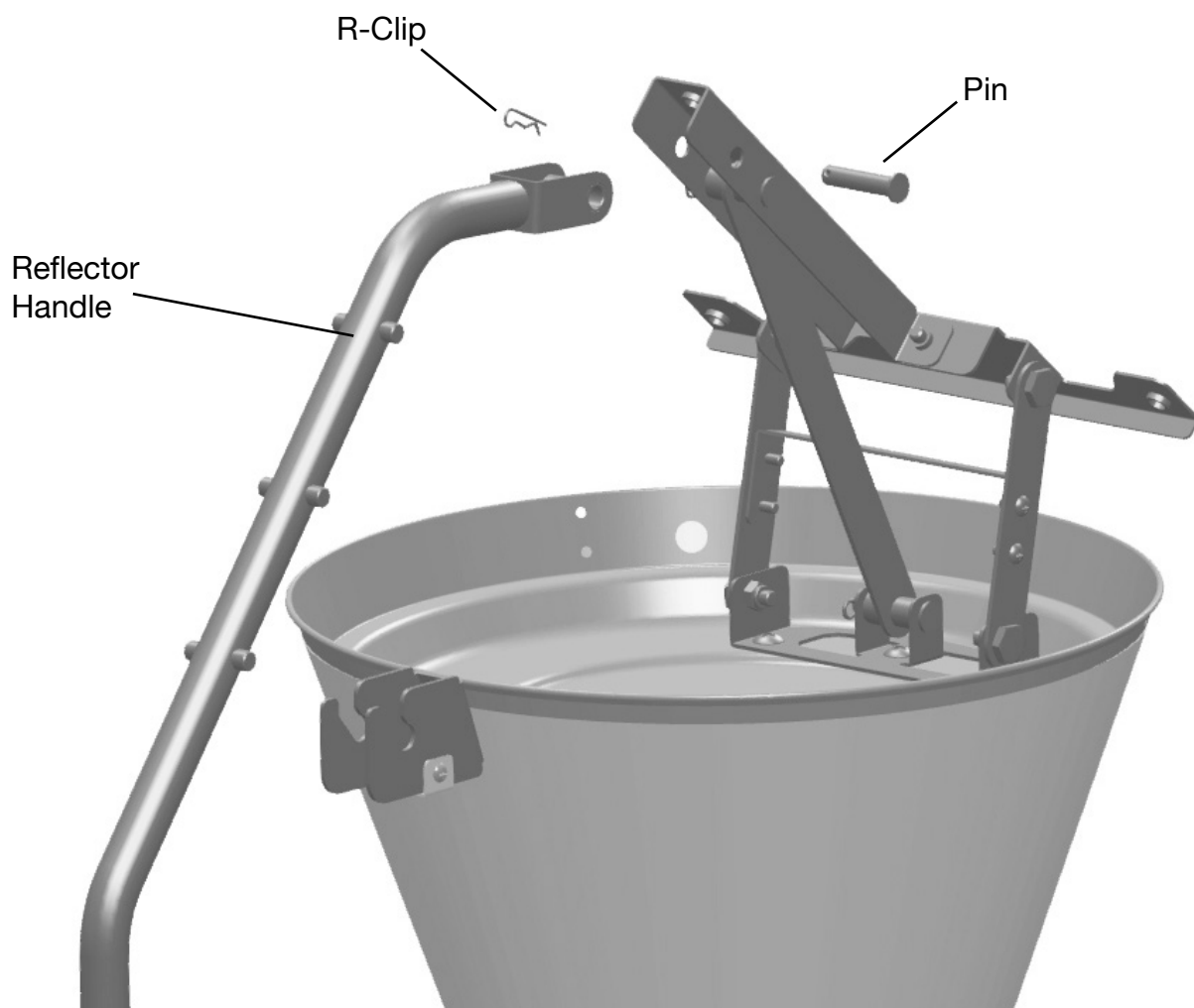

Assembly Step 10



5/16" Bolt (F)



5/16" Washer (E)

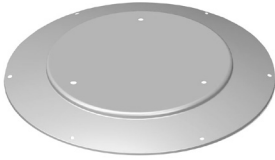

Top Panel



Side Panels



1/4" Dome Head Bolt (A)



1/4" Nut (B)

Loosely screw parasol side panels together using 12 of the 1/4" Dome Head Bolts (Ref. A) and 1/4" Nuts (Ref. B) overlapping as shown below. Fix the top panel to the top of the assembled side panels using 6 of the 1/4" Dome Head Bolts (Ref. A) and 1/4" Nuts (Ref. B) and then fully tighten all bolts.

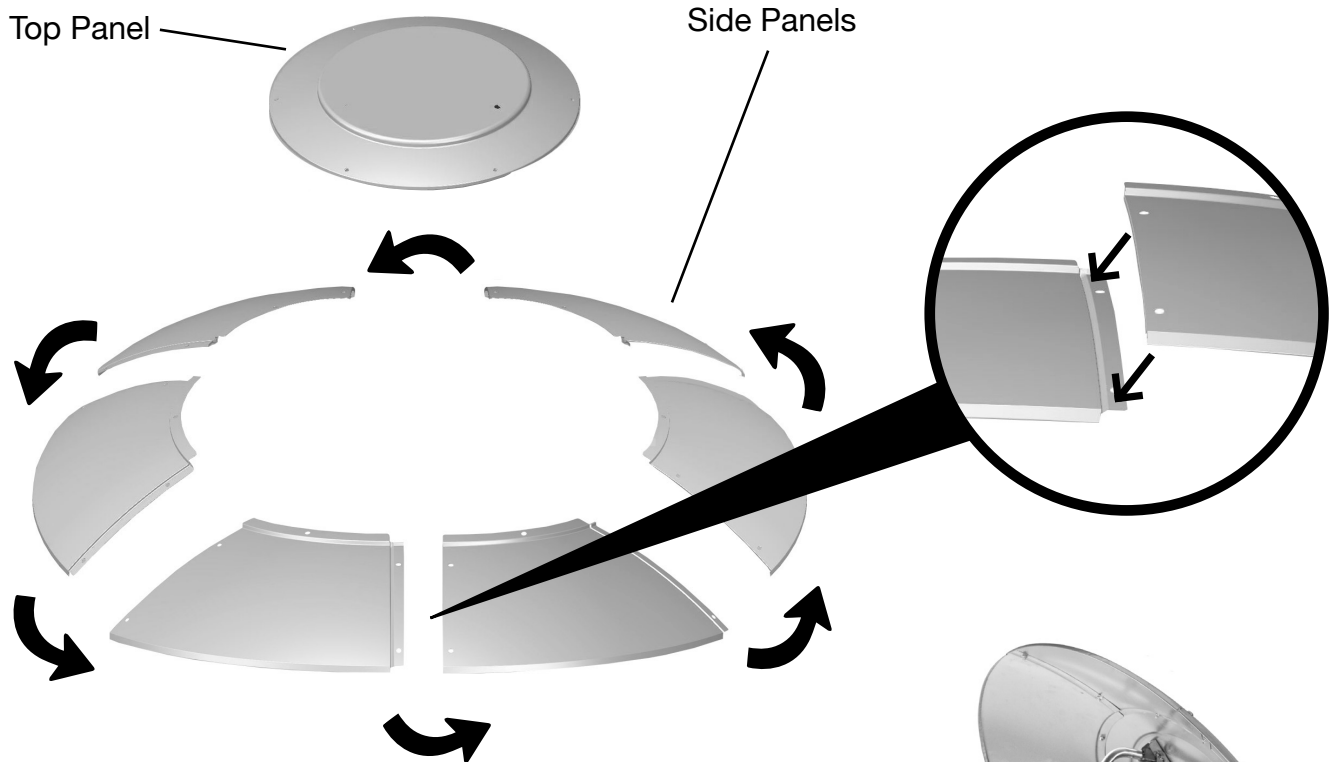

Fit reflector to lantern as shown using 3 of the 5/16" bolts (Ref. F) and washers (Ref. E).



For all appliances:

- The heater, when installed, must be electrically grounded in accordance with local codes or, in the absence of local codes, with the National Electrical Code, ANSI/NFPA 70, or the Canadian Electrical Code, CSA C22.1.
- Certain materials or items, when stored under the heater, will be subjected to radiant heat and could be seriously damaged.
- Inspect the visible portion of the hose before each use of the appliance. Hose inside cylinder pole housing should be checked annually and a leak test should be performed when re-assembled.
- Children and adults should be alerted to the hazards of high surface temperatures and should stay away to avoid burns or clothing ignition.
- Young children should be carefully supervised when they are in the area of the heater.
- Clothing or other flammable materials should not be hung from the heater, or placed on or near the heater.
- Any guard or other protective device removed for servicing the heater must be replaced prior to operating the heater.
- Installation and repair should be done by a qualified service person. The heater should be inspected before use and at least annually by a qualified service person. More frequent cleaning may be required as necessary. It is imperative that control compartment, burners and circulating air passageways of the heater be kept clean.
- Keep the appliance area clear and free from combustible materials, gasoline and other flammable vapors and liquids.
- Do not obstruct the flow of combustion and ventilation air.
- Keep the ventilation opening of the cylinder enclosure free and clear from debris.

An appliance may be installed with shelter no more inclusive than:

- a. With walls on all sides, but with no overhead cover.
- b. Within a partial enclosure which includes an overhead cover and no more than two side walls. These side walls may be parallel, as in a breezeway, or right angles to each other.
- c. Within a partial enclosure which includes an overhead cover and three side walls, as long as 30 percent or more of the horizontal periphery of the enclosure is permanently open.

The LP-gas supply cylinder to be used must be:

- a. Constructed and marked in accordance with the specifications for LP-gas cylinders of the U.S. Department of Transportation (DOT); or the Standard for cylinders, Spheres and Tubes for Transportation of Dangerous Goods and Commission, CAN/CSA-B339, as applicable;
- b. Provided with a listed overfilling prevention device; and
- c. Provided with a cylinder connection device compatible with the connection for the appliance.
- d. 20LB (9kg) cylinder. LPG capacity 4.7 gallons (17.8 litres) Cylinder Dimensions: Height 17.75 inches (451mm) and width 12.25 inches (311mm)
- e. The LP - gas cylinder used must include a collar to protect the cylinder valve.

A cylinder must be stored outdoors in a well-ventilated area out of reach of children. A disconnected cylinder must have dust caps tightly installed and must not be stored in a building, garage or any enclosed area. The pressure regulator and hose must be used and any replacement pressure regulator or hose must be those as specified by the manufacturer.

Do not store spare LP-gas cylinder under or near this appliance.

Never fill the cylinder beyond 80 percent full; and for appliances designed to use a CGA No. 791 Connection: Place the dust cap on the cylinder valve outlet whenever the cylinder is not in use. Only install the type of dust cap on the cylinder valve that is provided with the cylinder valve. Other types of caps or plugs may result in leakage of propane.

Leak Testing

- To be performed in a well ventilated area.
- Confirm all control knobs are in the off position.
- Open the gas control valve on the bottle.
- Check for leaks by brushing a solution of 50% water and 50% dish soap over the gas system joints, including all valve connections, hose connections and regulator connections.
- **NEVER USE AN OPEN FLAME** to test for leaks at any time.
- If bubbles form over any of the joints, there is a leak.
- Turn off gas supply and retighten all joints.
- Repeat test. If bubbles form again, do not use the patio heater. Please contact the helpline stated in this manual.
- Leak test annually and whenever the gas bottle is removed or replaced.

Gas and Regulator

- The gas hose must be connected in accordance with these instructions. When installed correctly all parts of the hose should be contained within the Patio Heater pole and gas cylinder chamber. No part of hose should be outside of the Patio heater body where it could be a trip hazard or could be accidentally damaged.
This appliance is for propane use only.
- See instructions supplied with regulator for correct use and attachment.
- Gas bottles should never be stored on their side.
- Never store gas bottles indoors.
- **This appliance is supplied with a propane regulator which must only be used for propane gas. NEVER use an adjustable regulator with this appliance.**
- Please consult your gas dealer for the most suitable gas bottles for your regulator.

Siting Instructions

- This appliance is for OUTDOOR USE ONLY and should be placed in a well ventilated area.
- A well ventilated area must have a minimum of 30% of its surface area open.
(Surface area is defined as the total surface of the walls surface.)
- The sides of the appliance should NEVER be closer than 40 inches (1m) from any combustible surface.
- Keep this appliance away from any flammable materials!
- Important - Make sure the gas bottle is placed level within the base.
- Should you need to change the gas bottle, confirm the gas supply is turned off at the regulator or bottle / cylinder valve, and there are no sources of ignition (cigarettes, open flame, sparks, etc.) near before proceeding.
- Inspect the gas hose to ensure it is free from any twisting or tension. The hose should hang freely with no bends, folds, or kinks that could obstruct free flow of gas. Always inspect the hose for cuts, cracks, or excessive wear before use. If the hose is damaged, it must be replaced with hose suitable for use with LPG and meet the national standards for the country of use.

Connecting to the cylinder

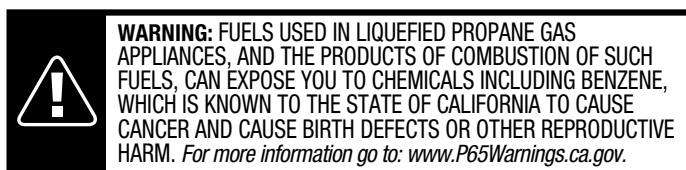

- Confirm all control knobs are in the off position.
- Connect the regulator to the gas bottle according to your regulator and bottle dealers instructions.



Use Instructions

Before proceeding make sure you understand the warnings section of this manual.

Lighting instructions:

- Fit battery to sparker.
- Turn on gas supply at cylinder.
- Push dial in and turn to position .
- While dial is held pressed in at position , press spark button to ignite the heater.
- Hold dial in for at least 10 seconds to ensure heater stays lit.
- If heater does not light after holding dial in for 20 seconds wait 5 minutes and try again.
Do not continuously hold the dial in as you may cause a build up of gas.
- In windy conditions shield from wind to ensure easy lighting and hold dial in for at least 20 seconds to ensure heater stays lit.
- Turn control dial to high or low flame position as required.
- Correct operation of the heater is indicated by a predominantly blue quiet flame.

If the sparker fails you can light your patio heater using a match.

To light Patio Heater with match:

1. Place lit match through the gap below the burner mesh and wind guard.
2. Turn the control dial to the  position. After burner ignites, keep control dial held in for 10 seconds to ensure burner stays lit and then release.
3. If the burner does not light after holding the control dial in for 20 seconds with the lit match in position, remove the match, turn the control dial to the off position, wait 5 minutes and then repeat.

To Turn Off:

- Push dial in and turn to position .
- Turn the gas **off** and disconnect at the cylinder when not in use.
- Remove battery from ignition unit during prolonged periods of non-use.

Flame Characteristic

The flame pattern at the burner mesh should be visually checked whenever the heater is operated. Normally the burner flame is blue with yellow flame at the top. The Burner mesh will become red hot. If flames extend beyond the surface of the burner mesh, or the phenomena of flame lift or light back, or black spot is accumulating on the burner mesh or reflector, the heater should be turned off immediately. The heater should not be operated again until the unit is serviced or repaired.

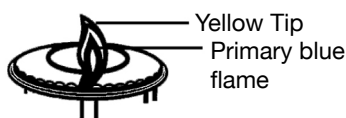

Care and Maintenance

- Regularly clean your patio heater between uses and especially after extended periods of storage.
- Ensure the heater control is turned fully to the off position, the gas supply is shut off at the regulator or bottle / cylinder valve, and the heater and its components are sufficiently cool before cleaning.
- Never douse the heater with water when its surfaces are hot.
- We recommend that servicing of this appliance should be performed either after every 100 hours of use or annually, whichever is achieved soonest.

Fixings

All screws and bolts, etc, should be checked and tightened on a regular basis.

Storage

- Remove battery from ignition unit during prolonged periods of non-use.
- Do not leave the patio heater exposed to outside weather conditions or stored in damp moist conditions.
- To save space during long-term storage, the reflector can be removed. Take care to ensure the shape of the reflector is not damaged or deformed, as this will affect performance.

- When using the heater after extended periods of storage, re-attach the reflector. The heater should never be operated without the reflector in place.
- If the heater is to be stored indoors, the gas bottle must be disconnected and left outside in a dry, well-ventilated area, away from any sources of heat or ignition.
- Do not let children tamper with the bottle.

Service

If your heater needs maintenance or is not working properly, please contact your local authorized agent for service. It is a necessity to contact an authorized source for replacement of parts and/or servicing. This work must be carried out by a qualified gas technician. Spare parts may be obtained by contacting our spare parts department by email: info@uigroup.ie

WARNINGS

- NEVER use indoors, in an enclosed area or below ground level.
- This appliance is intended for use with LPG bottled gas only.
- This appliance features a flame failure and tilt device. In the event of a wind blowing the flame out or the unit being tipped over, the gas supply will be cut off from the cylinder. In this event, the knobs should be set to off and you should wait 5 minutes before re-lighting.
- Failure to read and follow these instructions could result in serious injury or damage to property.
- This product will become hot when in use – take care when touching.
- Keep children and pets at a safe distance from the unit when in use.
- DO NOT move this product when in use.
- Any modification of this appliance may be dangerous.
- DO NOT use heater where the reflector is within 40 inches (1m) of any flammable structure or surface.
- NEVER operate the heater with the top half covered (burner head, reflector, etc.)
- DO NOT leave this product unattended when in use.
- Always keep the cylinder level and vertical when positioning inside the base.
- ONLY use this appliance on a flat LEVEL non flammable surface or ground.
- Positioning, ensure the unit is a minimum of 40 inches (1m) from flammable items or structure from all sides and above.
- Always leak test the unit before use, annually, or after storage, when parts are replaced/serviced or if the gas cylinder is removed or replaced.
- When storing the appliance or gas cylinder, ensure they are away from flammable materials or liquids.
- Regularly check that the regulator seal and hose is fitted and that it is in good condition. Replace parts if necessary.
- Always follow the care and maintenance instructions – regularly maintain your appliance.
- Always replace worn parts – do not use the appliance if a leak, wear, or damage is found.
- DO NOT store or cover the appliance until fully cooled.
- Always shut off the valve at the gas cylinder or the regulator before moving the appliance.
- In the event of high winds particular attention must be taken. Store the unit away or ensure it is at a safe distance from other items in the event that the unit is blown over.
- Only use with gazebo's specifically designed to be used with patio heaters.
- Ensure the heater is at a safe distance from glass and PVC doors and windows to stop damage from any heat build up.
- Read the warnings and use instructions before operation.

Warning: Do not leave the heat focusing reflector of the patio heater in the tilt position during rain or windy conditions or when the patio heater is not in use or unattended.

Always position the heat focusing reflector in the full down position when not in use or during windy or rainy conditions.



DURING RAIN/HIGH WIND CONDITIONS OR WHEN UNATTENDED

CAUTION

- It is normal for the heater to smoke during the first few minutes of use.
- If you smell gas – turn off the appliance and extinguish all flames. If the odour continues, immediately contact your gas supplier.
- In the event of an uncontrollable fire, immediately disconnect the gas cylinder moving it away from fire and contact the fire services. **DO NOT PUT YOURSELF AT RISK!**
- Ensure aerosols are not used near this unit when in use.
- Ensure all packaging and plastic bags are disposed of safely.

Technical Data

Overall Height:	86.6” approx.
Overall Weight:	82.6lbs approx.
Overall Width:	34”
Heater Heat Input(-Qn):	38,200 Btu/h
Heater Gas Consumption:	2.0 Lbs per hour
Heater Injector Size:	0.07”
Setting Pressure:	11” per W.C
Regulator Outlet Pressure:	11” per W.C
Standard	ANSI Z83.26-2014 • CSA2.37-2014 Gas Fired Outdoor infrared Patio heaters
Gas Supply Pressure	Max.250 PSI, MIN.5 PSI

Specifications are subject to change without prior notice.
 Universal Innovations,
 Kilcoole Ind. Est.,
 Kilcoole,
 Co. Wicklow,
 Ireland.

Shall be used only in a well ventilated space and shall not be used in a building, garage or any other enclosed area. May be installed in shelter no more inclusive than:

- With walls on all sides but with no overhead cover.
- Within a partial enclosure which includes an overhead cover and no more than two side walls. These side walls may be parallel, as in a breezeway, or at right angles to each other.
- Within a partial enclosure which includes an overhead cover and three side walls, as long as 30% or more of the horizontal periphery of the enclosure is permanently open.

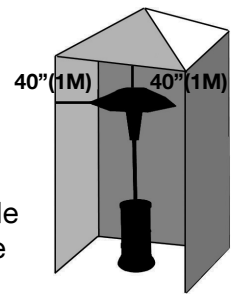

Warranty

Keep these instructions for future reference. The patio heater has been manufactured under the highest standards of quality and workmanship. We warrant to the original consumer purchaser that all aspects of this product will be free of defects in material and workmanship for 1 year from the date of purchase. A replacement for any defective part will be supplied free of charge for installation by the consumer. Defects or damage caused by the use of other genuine parts are not covered by this warranty. This warranty shall be effective from the date of purchase as shown in the purchaser’s receipt. This warranty is valid for the original customer only and excludes product damage due to shipment or failure which results from alteration, product abuse or product misuse whether performed by a contractor, service company, or consumer. We will not be responsible for labor charges and/or damage incurred in installation, repair or replacement, nor for incidental or consequential damage.

Contact: info@uigroup.ie **Tel:** (678) 534 2876