

Ipe Clip®

Hidden Deck Fasteners

Manufactured By DeckWise®



Stainless Steel Insert



Corrosion resistant, black oxide stainless steel insert increases hold down strength and eases installation by helping to prevent over-driving of screws.

Gap Spacing

Our line of deck fasteners offer a vast array of gap spacing options. Whether installing air or kiln dried hardwood, thermally modified softwood, composite or PVC decking, we have the appropriate fastener with at least three different gap spacing options for your particular decking.

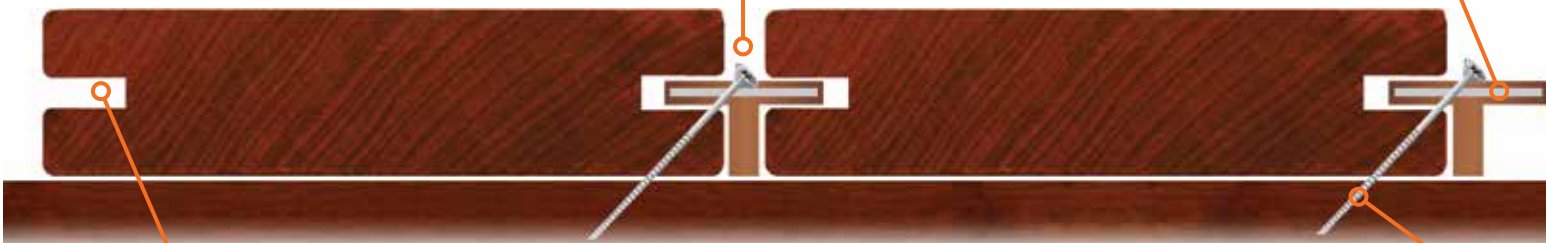

Positioning Decking Grooves

Symmetrical groove profile allow boards to be reversed and/or flipped to put the best side up.



Cutting Decking Grooves

Many lumber yards now offer pregrooved materials in stock.

-OR-

Cut the groove yourself using a standard biscuit joiner or router with a 5/32" slot cutter.



Screws Driven at a 45° Angle

Ability to run screws at a 45 degree angle through hardwoods greatly increases hold-down strength. Studies have proven that screws have more holding strength when ran on an angle. This method also maintains even gap spacing while properly allowing boards to expand and contract with the seasons.

These products are protected under one or more of the following patents; D485,160; 8,464,488; Other Patents Pending, and/or D470,039 product is licensed under U.S. Patent No. 6,402,415

Why a plastic coating over a steel insert?

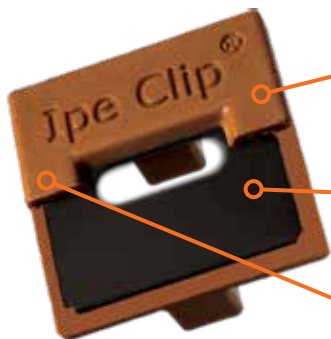

Unlike most all-metal hidden deck fasteners, which can react with wood causing staining, the Ipe Clip® is molded of a malleable plastic polymer resin coating (further adding UV & chemical resistant qualities), allowing for the natural expansion/contraction of wood decking.

Our rigid stainless steel insert firmly holds decking to joists (up to 3X more hold-down strength than other edge-mount deck fasteners), eliminating decking screws from pulling through as the deck material expands.

Designed for exotic hardwoods, the color of the plastic resin also works to further camouflage and conceal our fasteners between the board gaps for a more sleek, upscale surface.

DeckWise® Hidden Deck Fastener Approximate Coverage

Approximate coverage for 100 Count Kit of DeckWise® fasteners

Joist Spacing	Width of Deck Boards	
	3½"	5½"
24"	50 ft²	100 ft²
16"	36 ft²	57 ft²
12"	25 ft²	50 ft²

Approximate coverage for Full 175 Count Kit of DeckWise® fasteners

Joist Spacing	Width of Deck Boards	
	3½"	5½"
24"	87 ft²	175 ft²
16"	63 ft²	100 ft²
12"	44 ft²	87 ft²

Decking Groove Profile



A = 5/32" (4mm)

B = 1/2" (13mm)

C = Measurement of the deck board thickness being installed.

D = (C-A)/2 *Note: this will center the groove in the board*

1x6 Example

Let's say you are installing 1x6 decking, that would mean that:
 C = 3/4"
 D = (3/4"-5/32")/2
 D = (19/32")/2
 D = 19/64" (7.54mm)

5/4x6 Example

Let's say you are installing 5/4x6 decking, that would mean that:
 C = 1"
 D = (1"-5/32")/2
 D = (27/32")/2
 D = 27/64" (10.72mm)



Flawless Deck Surface

When DeckWise® hidden deck fasteners are used for the installation of a deck, a flawless surface can be achieved that is free of any ugly nail and/or screw heads.



Decking Grooves

Whether using pregrooved decking or having the slots cut on the job site, DeckWise® hidden deck fasteners fit perfectly into the groove with plenty of tolerance to allow for an easy installation.

DeckWise® Line of Ipe Clip® Hidden Deck Fasteners Gap Spacing

DeckWise® Hidden Deck Fasteners Standard



DeckWise® Hidden Deck Fasteners Extreme™



DeckWise® Hidden Deck Fasteners Extreme4™



DeckWise® Hidden Deck Fasteners ExtremeKD™



Smallest Gap Spacing at Time of Installation

Largest Gap Spacing at Time of Installation



Manufactured By DeckWise®

Use With Exotic Hardwoods, Thermally Modified Softwoods & Composite Decking.



Hardened stainless steel insert with a black oxide coating inside rigid UV and chemical-resistant polypropylene.

Smaller leg maintains a perfect gap when materials contract due to environmental conditions.

Features:

- Automatically spaces deck boards at 3/32" (2,38mm)
- Manufactured from polypropylene with stainless steel; black oxide insert
- For use with air dried hardwood, composite, or PVC decking
- Allows for contraction of width of air dried hardwoods
- Allows movement of length with composite/PVC decking
- Unique design allows for more tolerance in grooved side profile while increasing hold-down area
- UV resistant
- Limited Lifetime Warranty

Fastener Dimensions

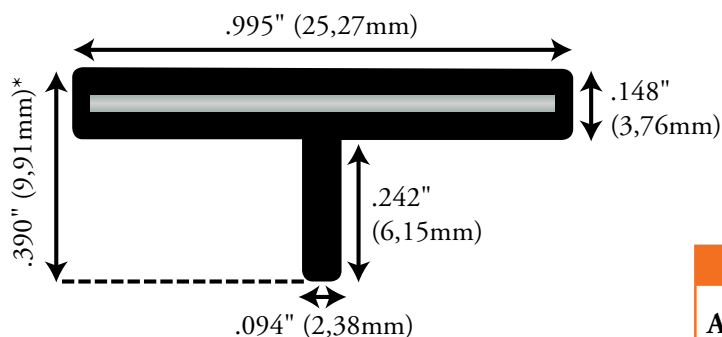

Clip Construction		
Material	Stainless Steel Insert	Available Colors
Polypropylene/ Fiberglass	.883" x .883" Thickness: .036"	

*Short version shown above
Tall version = .375" (9,525 mm)

Decking Compatibility		
Air-Dried Decking	Kiln-Dried Decking	Composite/ PVC Decking
✓	✗	✓

Allows Contraction on the Width of Air-Dried Lumber



The method of 45 degree screws hold the decking tight to the joist, while allowing one side of the deck board to remain free to contract and expand.

Allows Expansion/Contraction Along the Length of Composite/PVC Decking



Running screws straight down with composite/PVC decking allows these materials to naturally move on their length.

DeckWise® Extreme™ Installation Specifications

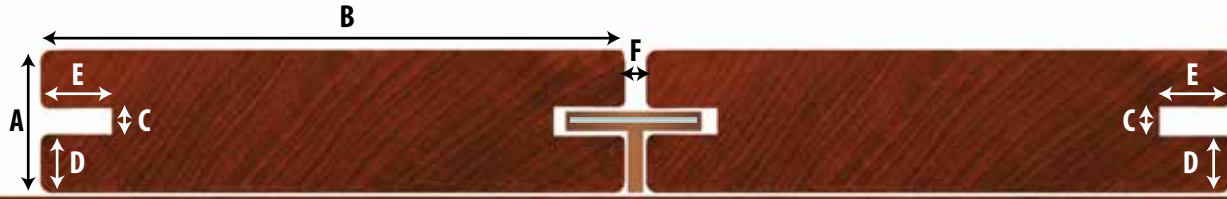

Board Dimensions		Groove Dimensions			Board Spacing
Board Thickness	Board Width	Thickness of Cut	Cutting Height	Cutting Depth	During Installation
A* = Measurement Of Your Decking	B** = Measurement Of Your Decking	C = 5/32"(4mm)	D*** = (A-5/32")/2	E = 1/2"(13mm)	F**** = 3/32" (2,38mm)

* If using 1-1/2" or thicker material, you may need to upgrade to a longer screw option than what is typically packaged with the fastening kit.

** For decking 8" or wider, the (A) dimension should be at least 1-1/2". Using a wide plank such as this for surface decking will most likely cause cupping issues regardless of how the material is fastened if thicker material is not used.

*** This formula will create a symmetrical profile that allows you to flip and/or rotate the decking to be able to put the best side up.

**** Fastener automatically achieves correct gap spacing when boards are pushed tight during installation.

Complete Kit Contains

- (175) IPE CLIP® Extreme™ Hidden Deck Fasteners
- (190) #8x2" Colormatch Black Stainless Steel Star Drive Screws
- (12) 3/8" Tapered Ipe Plugs
- (1) 1/8" High Speed Drill Bit
- (1) T15 Star Drive Tip
- (1) Instruction Sheet

100 Ct. Kit Contains

- (100) IPE CLIP® Extreme™ Hidden Deck Fasteners
- (100) #8x2" Colormatch Black Stainless Steel Star Drive Screws
- (1) Instruction Sheet

2 Gal. Contractor Bucket	5 Gal. Contractor Bucket
<ul style="list-style-type: none"> (525) Hidden Deck Fasteners (565) Stainless Steel Deck Screws (3) T15 Star Drive Tips (3) 1/8" High Speed Drill Bits (1) Instruction Sheet 	<ul style="list-style-type: none"> (1050) Hidden Deck Fasteners (1130) Stainless Steel Deck Screws (5) T15 Star Drive Tips (5) 1/8" High Speed Drill Bits (1) Instruction Sheet



Coverage varies, see coverage page in this manual.



#8x2" Colormatch Black Stainless Steel Star Drive Screws



3/8" Tapered Ipe Plugs



1/8" High Speed Drill Bit



T15 Star Driver Bit

Installation: Hardwoods vs Composite/PVC Decking

Explanation of Hardwood Installation

Achieve Even Gap Spacing

When DeckWise® hidden deck fasteners are screwed in at a 45° angle, this holds one side of the board in place while forcing all movement from the opposite side. This is the key to maintaining even gap spacing for the life of the deck while still allowing the natural movement of the hardwood. Studies have also shown that the hold-down strength of a screw is greater when it is driven through material at an angle as opposed to straight down. **Hidden fasteners eliminate surface damage such as from face screwing.**



Shown Above:
Ipe (Brazilian Walnut) Hardwood decking installed with DeckWise® Extreme™ hidden deck fasteners.

Hardwood Decking: Run screws at a 45° angle.



Prevent Nail Pops!

Hardwood decking naturally moves on its width as seasons and weather change. This movement rocks the nails (or screws) back and forth, thereby weakening them. This process eventually leads to the nail (or screw head) popping up or worse, the nails (or screws) snapping off completely.



Nail Pop

Protect The Deck Surface

Face screwing deck boards can create many problems after the installation is complete. The surface of the deck is compromised everytime a screw penetrates the face of the deck board because this allows water to soak into these exposed holes. This can cause huge problems down the road because the entire integrity of the deck surface is weakened which can cause checking and splitting.



Wood Rot

⊘ **Hardwood Decking:** Face screwing is NOT recommended.

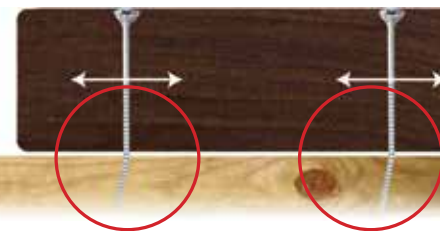
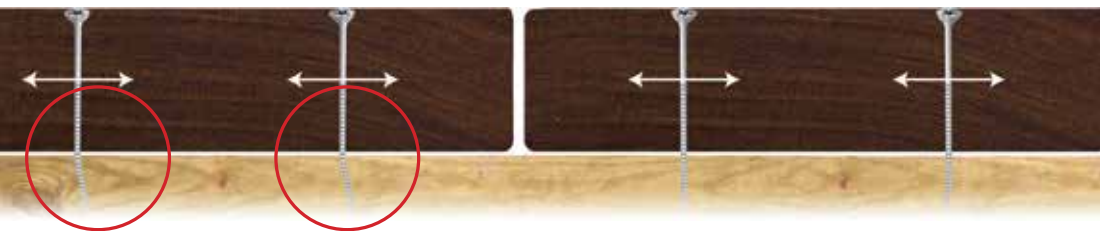

Shown Above:
Ipe (Brazilian Walnut) Hardwood decking installed with face driven screws.

Prevent Uneven Gap Spacing

Some hidden deck fasteners on the market that run screws straight down, claiming they prevent screws from breaking and weakening. What they fail to reveal is, that, when the hardwood decking naturally moves, nothing is holding the deck boards to the joist. They are free to slide between the fasteners resulting in uneven gap spacing.



Shown Above:
Ipe (Brazilian Walnut) Hardwood decking installed with hidden deck fasteners secured straight down.

⊘ **Hardwood Decking:** Fastening hidden deck fasteners straight down is NOT recommended.



Installation: Hardwoods vs Composite/PVC Decking

Explanation of Composite/PVC Installation

Achieve Even Gap Spacing

The DeckWise® hidden deck fastening system is one that allows you to run the screws straight down when installing composite or PVC decking. This installation technique allows the composite or PVC decking to expand and contract on its length. This is optimal with composite and PVC decking because unlike hardwoods, this material tends to expand on its length rather than width. Since they do not move on their widths like hardwood decking, your gap spacing will be maintained through the life of the product.



Shown Above:
Antique Grey composite decking installed with DeckWise® ExtremeKD™ hidden deck fasteners.

Composite Decking: Run screws straight down.



Composite Decking: This is a composite deck when viewed from the side... This illustrates the decking expanding on its length.

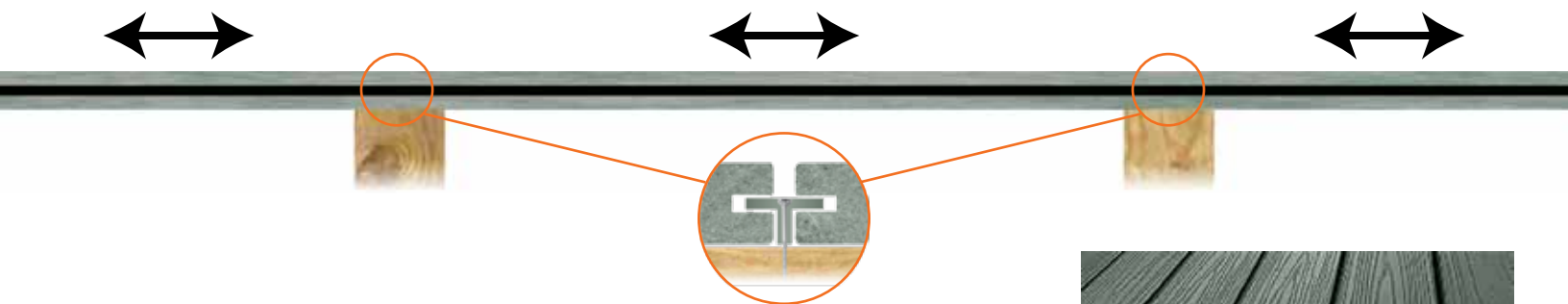

Prevent Nail Pops and Mushrooming!

Why would you want to blemish your brand new deck surface by running screws through the face of your composite or PVC deck boards during installation? Face screwing this material causes the surface to “mushroom” around the face driven screw. This creates a deck surface that is riddled with unattractive flaws. This method also weakens the screws because, as the composite material naturally expands and contracts, the screws get rocked back and forth and loosen their hold on the joist. This process almost always leads to the screw head popping out or worse, the screw snapping.

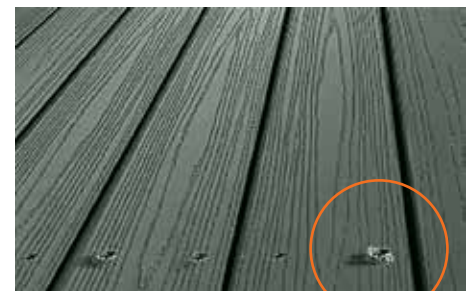

Shown Below:
Composite deck as seen from below. This illustrates how the decking moves on its length.

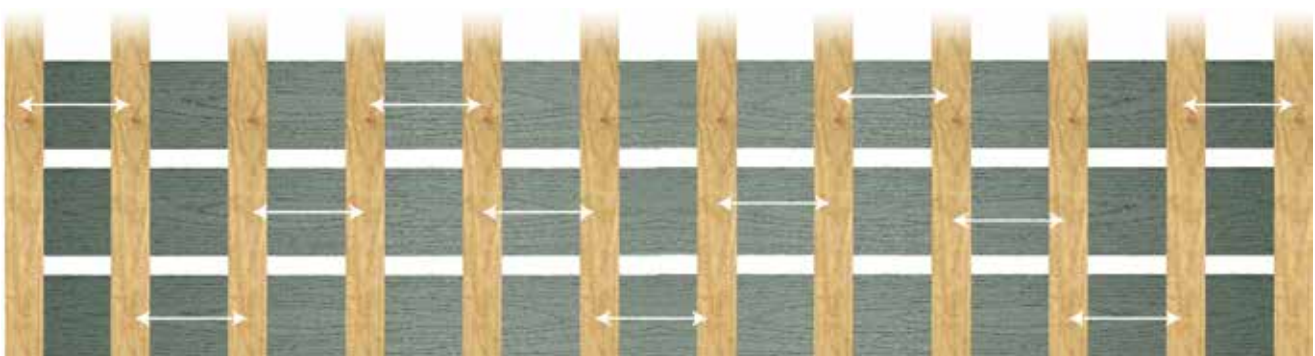

Board Replacement Step By Step

STEP 1: Cut the board that needs to be replaced down the center. If tight, making two cuts can help you remove the center portion of the board more easily.



Step Hint:

Use a circular saw to make the two center cuts on the deck board that is to be removed.

Step-by-step Directions:

1. Remove the center piece that was cut in the previous step.
2. Remove side sections of board (the side that the screw is running through will have to be pried out).
3. If screw breaks, pound flush into joist with hammer.

STEP 2: Remove the cut board and the fastener that was screwed through that board.

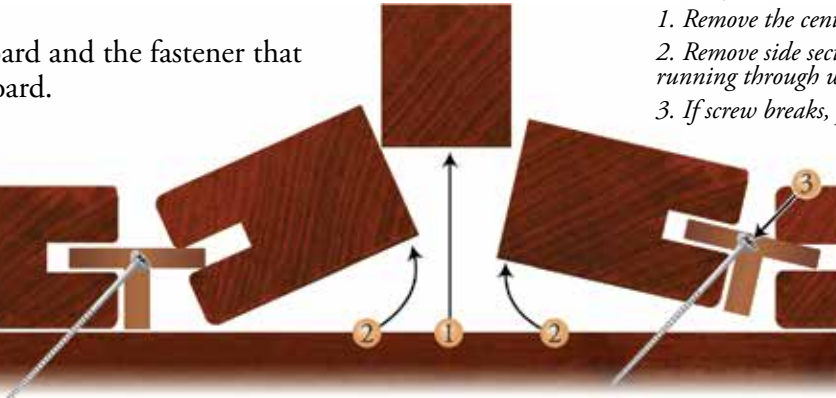

STEP 3: Run a screw at a 45° angle into the groove that you removed the DeckWise® fastener from.



STEP 4: Carefully slide a new deck board onto the exposed DeckWise® fastener.



Step Hint:

Installing a board with a groove on just one side of the deck board is optimal in this step.

STEP 5: Countersink a screw straight down into the side of the board that has no fastener and use a wood plug over the hole.

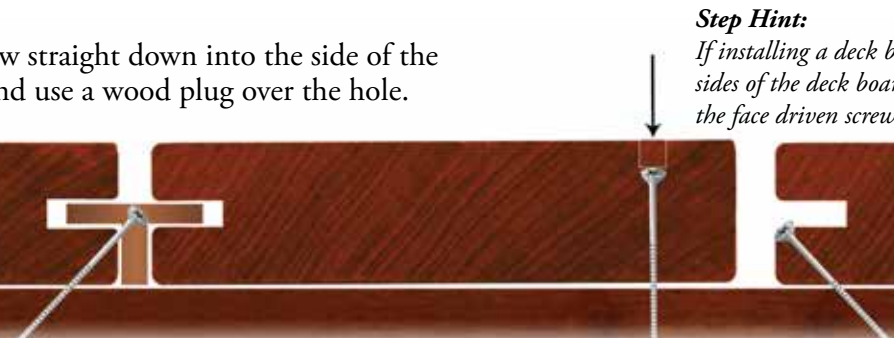

Step Hint:

If installing a deck board with grooves on both sides of the deck board, make sure not to drive the face driven screw through the groove.

Price Comparison

DeckWise® Hidden Deck Fasteners vs Face Screwing

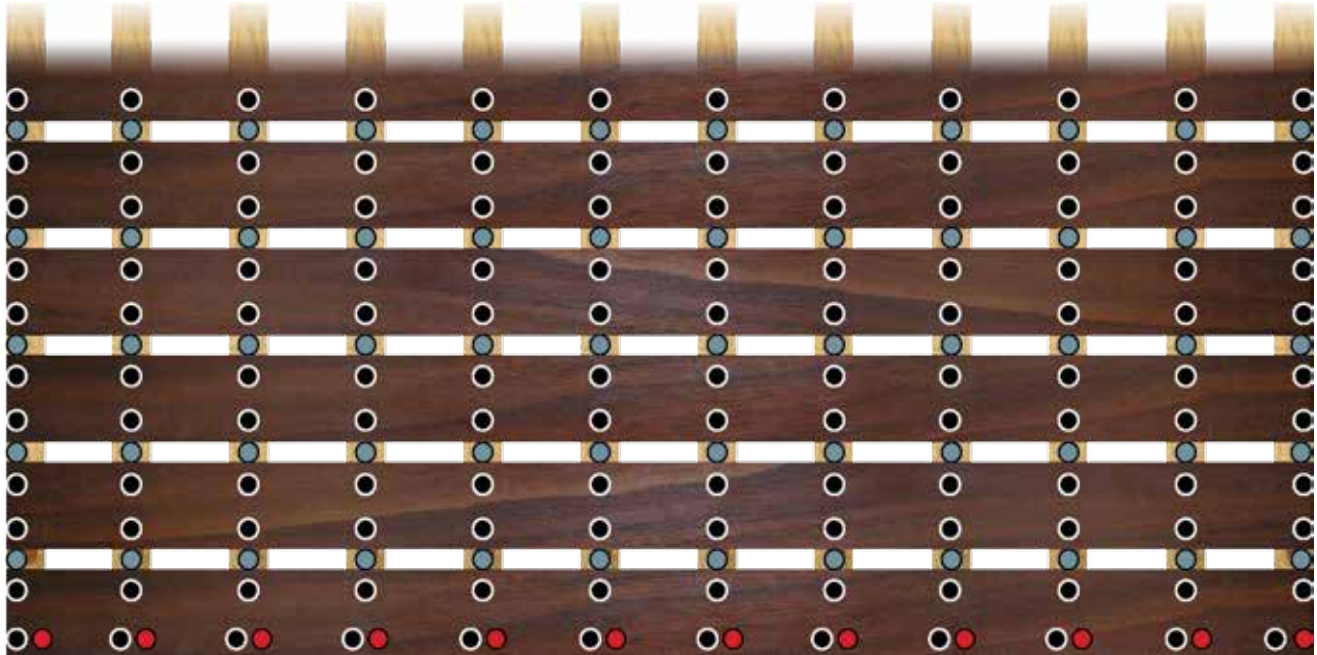

Face Screwing

Items Needed:
132 Screws

1 Package Stainless Steel Deck Screws = \$34.42* (100pcs)

132 - ●Screws = \$45.43

Total = \$45.43

NOTE: Quality and size of deck screws will vary price.

Standard

Items Needed:
60 DeckWise® Fasteners
72 Screws
12 Plugs

1 DeckWise® Standard fastener kit, screws included= \$96.00 (175pcs)

60 - ●DeckWise® Fasteners & Screws = \$32.91

12 - ●Extra Screws = FREE in kit

12 - ●Plugs = FREE in kit

Total = \$32.91

Extreme™ or ExtremeKD™ or Extreme4™

Items Needed:
60 DeckWise® Extreme™ Fasteners
72 Screws
12 Plugs

1 DeckWise® Extreme™ fastener kit, screws included= \$119.00 (175pcs)

60 - ●DeckWise® Extreme™ Fasteners & Screws = \$40.80

12 - ●Extra Screws = FREE in kit

12 - ●Plugs = FREE in kit

Total = \$40.80

Ipe Hardwood Decking Installed With Ipe Clip® Fasteners

Ipe Hardwood Decking Installed With Face Driven Screws



Decking System Clip Testing

Preliminary Test Results, 8/25/2010
 Robb Thomas, Lab Manager
 Tool Testing Lab, Inc.
 11180 N. Dixie Dr.
 Vandalia, OH 45377

UPLIFT TESTING



Introduction

Special clips can be used in decking systems to secure boards to joist. The following clips were fastened to a small joist and pull tested until failure to determine their strength. Each test consisted of fastening a metal board to the frame using 6 clips and the screws provided. A load cell was used to measure the force required to cause the clips to fail. Every test resulted in the screws pulling through the clip at the point in which the screws held them down.

Test Data:

Mfg	Model	Shape	Metal Core (Y/N)	Board Spacing (Inches)	Force at Failure (lbs.)
Ipe Clip	EXTREME4	Square	Yes	3/32"	1094
Ipe Clip	Standard	Circle	No	3/32"	497.5
Competitor A	Original	Oval	No	3/32"	451.5
Competitor B	Exotic	Rectangle	No	1/4"	322.5

Ashley Laboratories, LTD, 10/1/2010
 Report #28,674
 Joshua B. Taylor, C.E.F.
 10030 Harford Road
 Baltimore, Maryland 21234

SALT SPRAY TESTING



SCOPE: Salt Spray (Fog) testing pursuant to ASTM B117(09) on 20 parts for 96 hours with evaluations and digital photos every 24 hours.

RESULTS:

Black Oxide Encased (5 parts)	
Hours	Description
24	No Visible Red Rust (Corrosion)
48	No Visible Red Rust (Corrosion)
72	No Visible Red Rust (Corrosion)
96	No Visible Red Rust (Corrosion)

These parts meet or exceed the Salt Spray requirements of ASTM A-967 (Stainless Steel) and MIL-DTL-13924 (Black Oxide).

Suitability of fasteners for Decking Species & Dryness

Avoid using hidden fasteners with poor quality deck materials with high expansion and contraction rates

Species	Other Names	Dryness	Hidden Fastener			Face Screw
			Extreme™	Extreme4™	ExtremeKD™	
			Extreme™	Extreme4™	ExtremeKD™	ColorMatch Screws
Ipe	Brazilian Walnut, Lapacho, Tabebuia	Air Dried 16 to 20%	YES	YES	NO, wood will shrink and finished gap will be large.	YES
Pine		Kiln or Air Dried	No, wood will shrink off clip.	No, wood will shrink off clip.	No, wood will shrink off clip.	YES
Tigerwood	Muricatara, Goncalo Alves	Kiln Dried 14 to 16%	NO, wood could expand and cause buckling.	YES	YES	YES
		Air Dried	NO, this species should be kiln dried for decking use.	NO, this species should be kiln dried for decking use.	NO, this species should be kiln dried for decking use.	YES, but this species will be unstable unless kiln dried.
Garapa	Brazilian Ash	Kiln Dried	NO, wood could expand and cause buckling.	YES	YES	YES
		Air Dried	NO, this species should be kiln dried for decking use.	NO, this species should be kiln dried for decking use.	NO, this species should be kiln dried for decking use.	YES, but this species will be unstable unless kiln dried.
Massaranduba	Maçaranduba	Kiln Dried 14 to 16%	NO, wood could expand and cause buckling.	YES	YES	YES
Padouk	Padouk, Vermillon	Air Dried	NO, this species should be kiln dried for decking use.	YES	YES	YES
Acacia		Kiln Dried	NO, wood could expand and cause buckling.	YES	YES	YES
Bankirai	Balau	Kiln Dried	NO, wood could expand and cause buckling.	YES	YES	YES
Tatajuba		Kiln Dried	NO, wood could expand and cause buckling.	YES	YES	YES
Merbau		Kiln Dried	NO, wood could expand and cause buckling.	YES	YES	YES

Many other quality species of hardwood decking may be suitable for use with DeckWise® hidden deck fasteners, provided they are properly dried and do not have a high expansion or contraction rate.

Where both Extreme4™ and ExtremeKD™ is a option, it is typically a preference of the size of Gap spacing desired for looks. ExtremeKD™ is a larger Gap.