

ASSEMBLY INSTRUCTION
ITEM#: A101006400



For any questions or issues about our product

Call Sunjoy Customer Service

1(866) 578-6569

Country of Origin: CHINA

Safety Information

- Two people are required for this assembly.
- Some parts may contain sharp edges. Wear protective gloves.
- When assembling and using this product, basic safety precautions should always be followed to reduce the risk of personal injury and damage to equipment. Please read all instructions before assembly and usage.



CAUTION: Do not climb on top of the gazebo. Falling off the gazebo can result in serious injury.

NOTICE: For outdoor use



DANGER: This unit is heavy! Do not assemble this item alone.



WARNING: Do not leave the gazebo where there is a risk of high wind, as possible damage will occur to the structure.



WARNING: Keep all flame and heat sources away from this gazebo fabric. This Gazebo is made with fabric that meets CPAI-84 specifications for flame resistance. It is not fire proof. The fabric will burn if left in continuous contact with any flame source. The application of any foreign substance to the gazebo fabric may render the flame-resistant properties ineffective.

Warranty: 1 Year

WHAT IS COVER?

The limited warranty is extended to the original purchaser and applies to material and manufacturer's defect provided the item is maintained with care and used only for personal, residential purposes.

IMPORTANT

KEEP THIS INSTRUCTION MANUAL FOR FUTURE REFERENCE.

TOOLS NEEDED

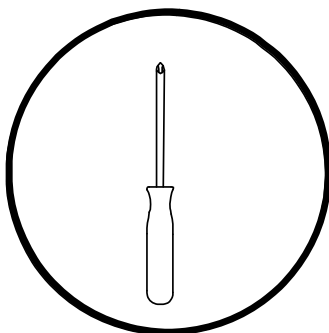
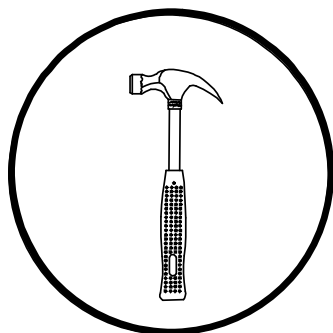

IMPORTANT

How many people needed for the installation work

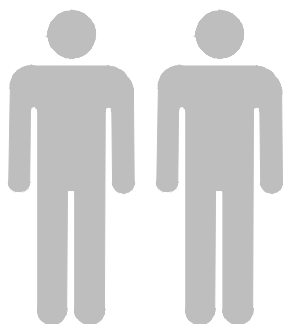



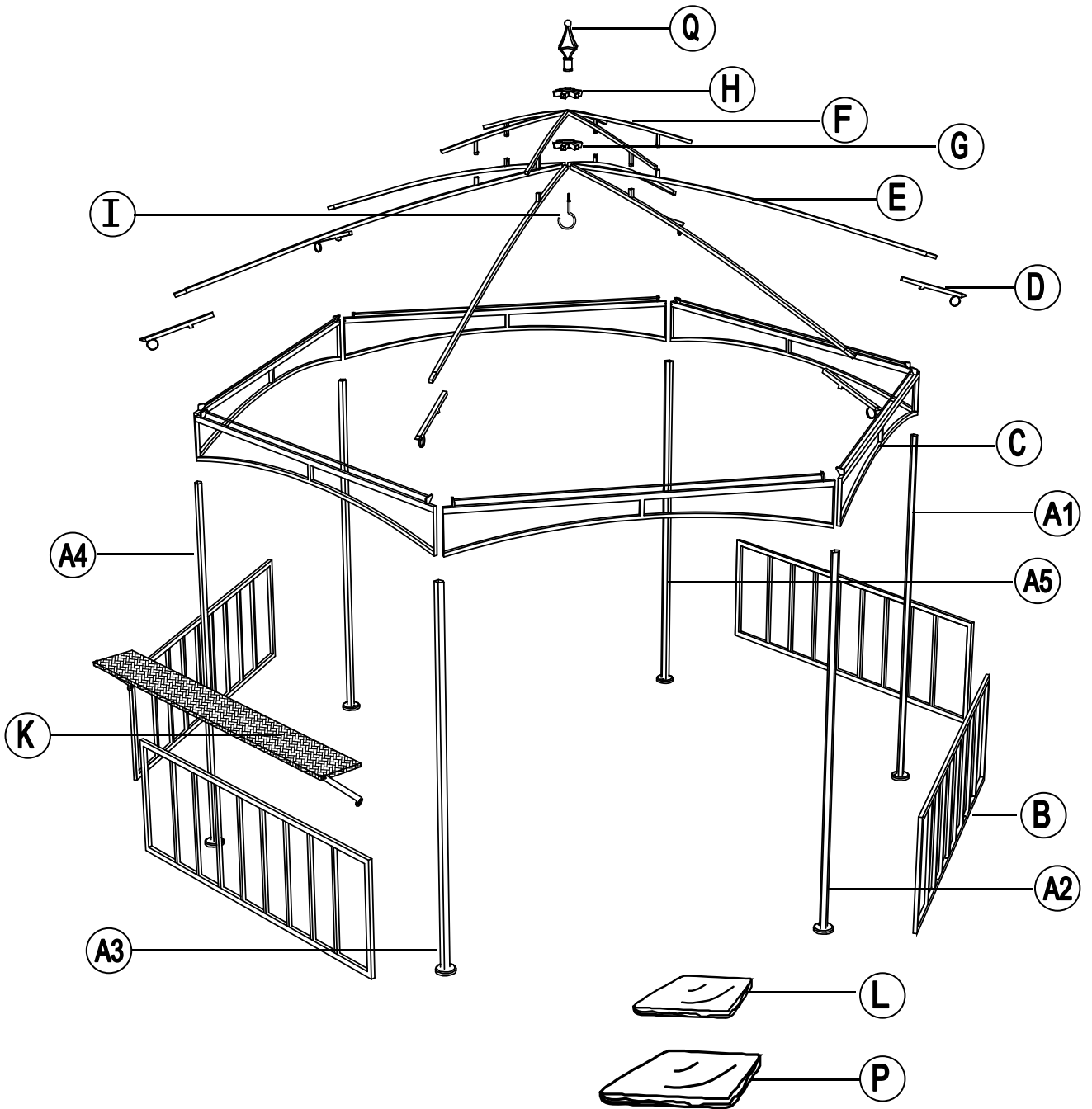







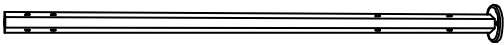
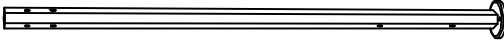
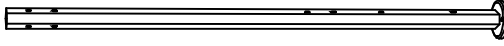
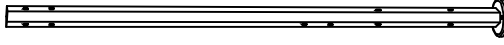

EXPLODED DRAWING

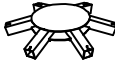

Country of Origin: CHINA





Call 1(866) 578-6569 for assistance.
Or visit us at www.sunjoyonline.com

Parts List

Label	Part Number	Description	QTY	Image of Part
A1	GZ0076XXD01	Post 1	1	
A2	GZ0076XXD02	Post 2	2	
A3	GZ0076XXD03	Post 3	1	
A4	GZ0076XXD04	Post 4	1	
A5	GZ0076XXD05	Post 5	1	
B	GZ0076XXD06	Fence Panel	4	
C	GZ0076XXD07	Frame	6	
D	GZ0076XXD08	Slant Beam End For Big Roof	6	
E	GZ0076XXD09	Slant Beam For Big Roof	6	
F	GZ0076XXD10	Slant Beam For Small Roof	6	
G	GZ0076XXD11	Big Top Connector	1	
H	GZ0076XXD12	Small Top Connector	1	
I	GZ0076XXD13	Hook	1	
K	GZ0076XXD14	Shelf	1	
L	GZ0076XXD15	Small Canopy	1	
P	GZ0076XXD16	Large Canopy	1	
Q	GZ0076XXD17	Finial	1	

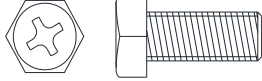
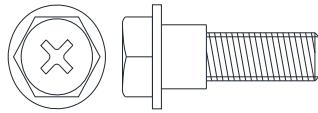
Country of Origin: CHINA

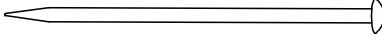
Call 1(866) 578-6569 for assistance.
Or visit us at www.sunjoyonline.com

Hardware Pack				
Label	Part Number	Description	QTY	Image of Part
AA	CM06015C	Bolt M6 X 15	46	 <p>Actual Size</p>
BB	GZ0076XXD18	Bolt M6 X 15	2	 <p>Actual Size</p>
CC	UD06C	Flat Washer M6	46	 <p>Actual Size</p>
DD	DD08260C	Stake Dia. 8 X 260	6	
Z	W10D	Wrench M6	2	

STEP 1: Assembly of Frame

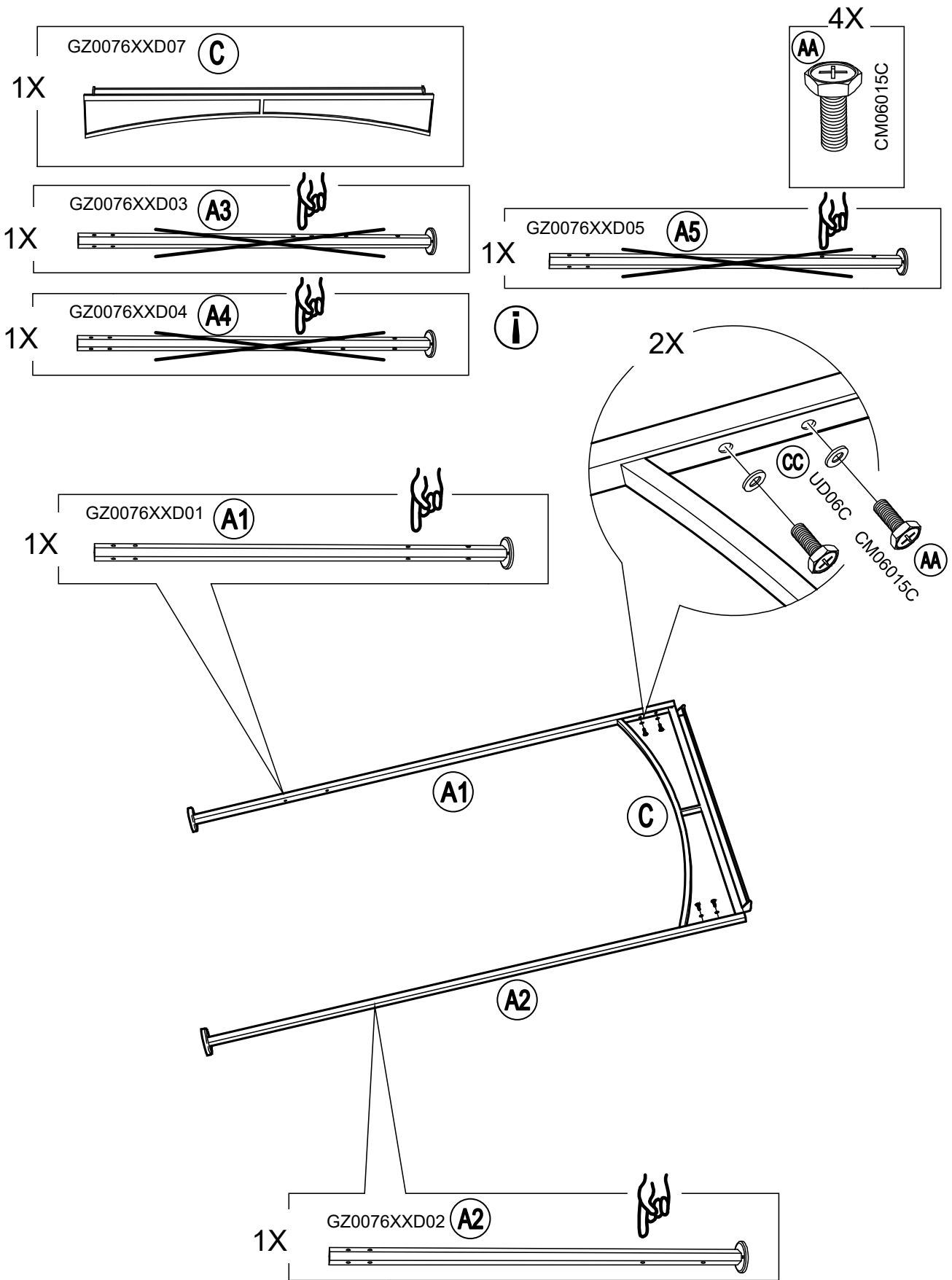

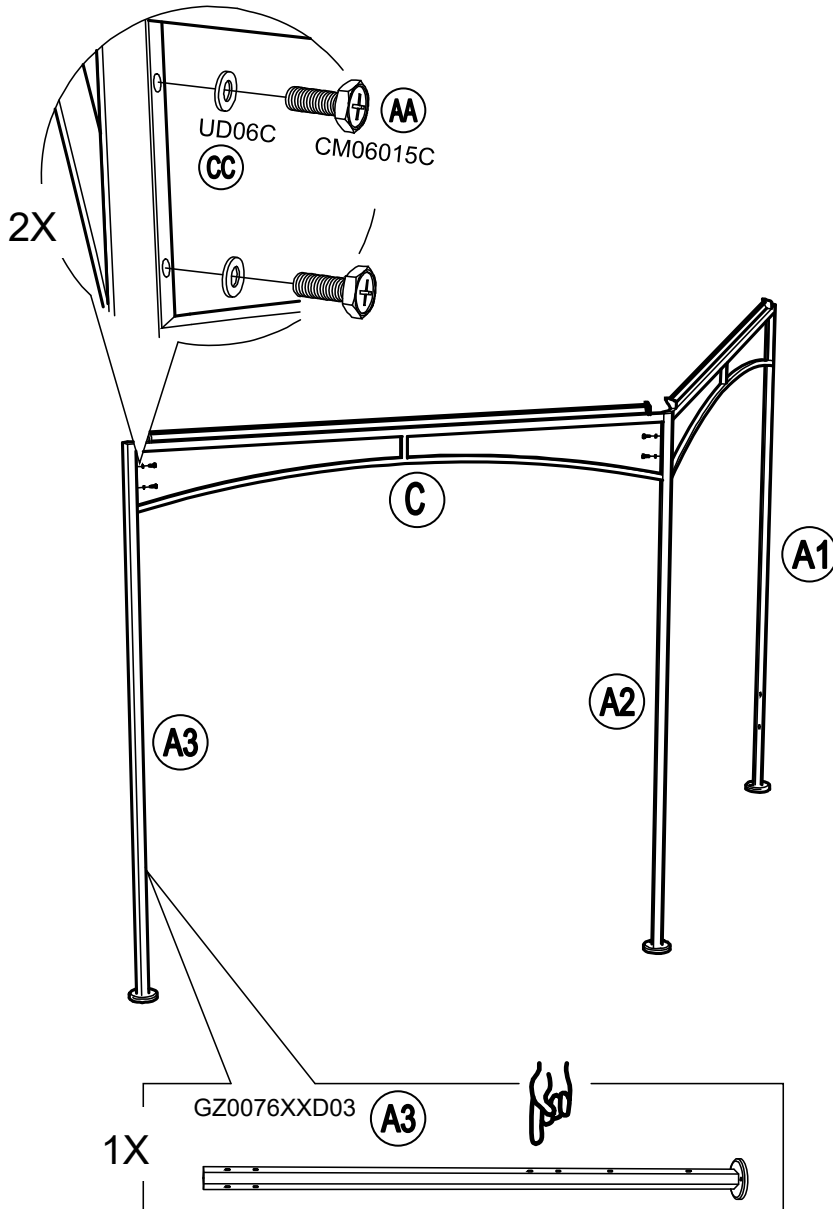
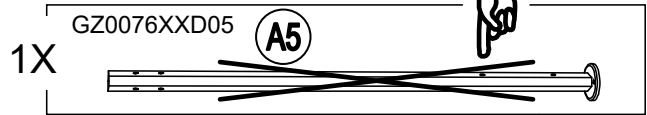
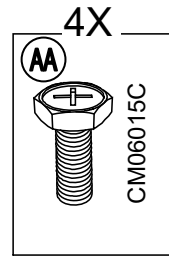
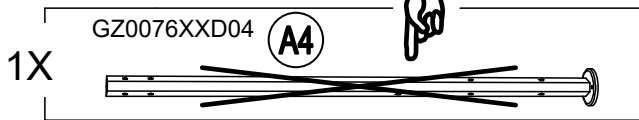
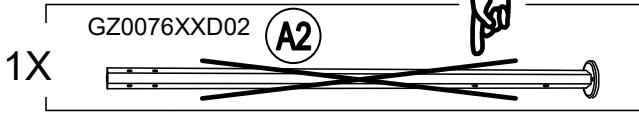
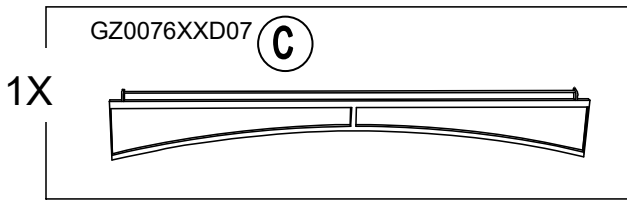

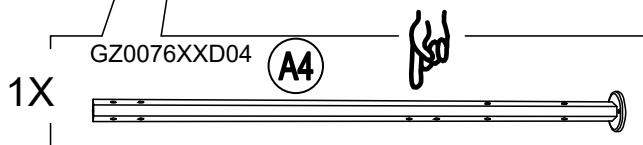
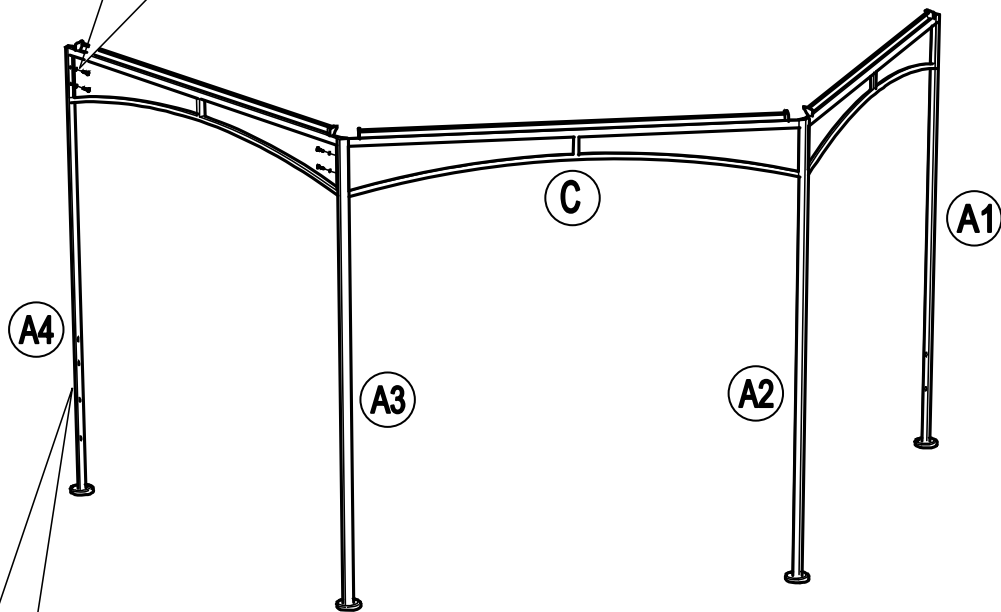
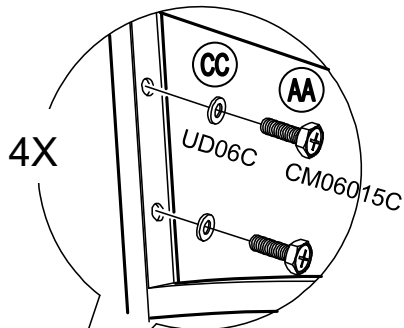
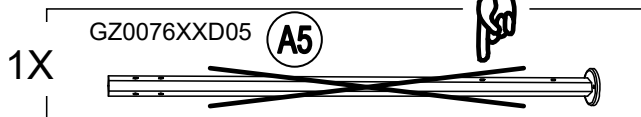
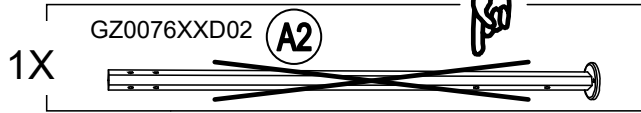
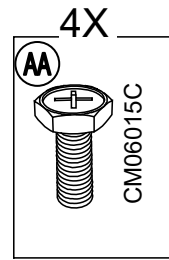
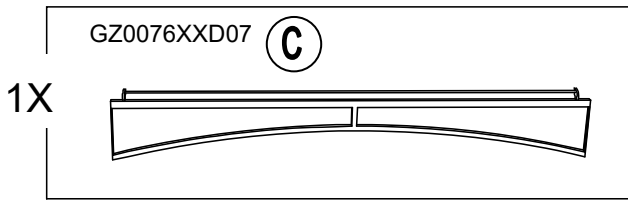

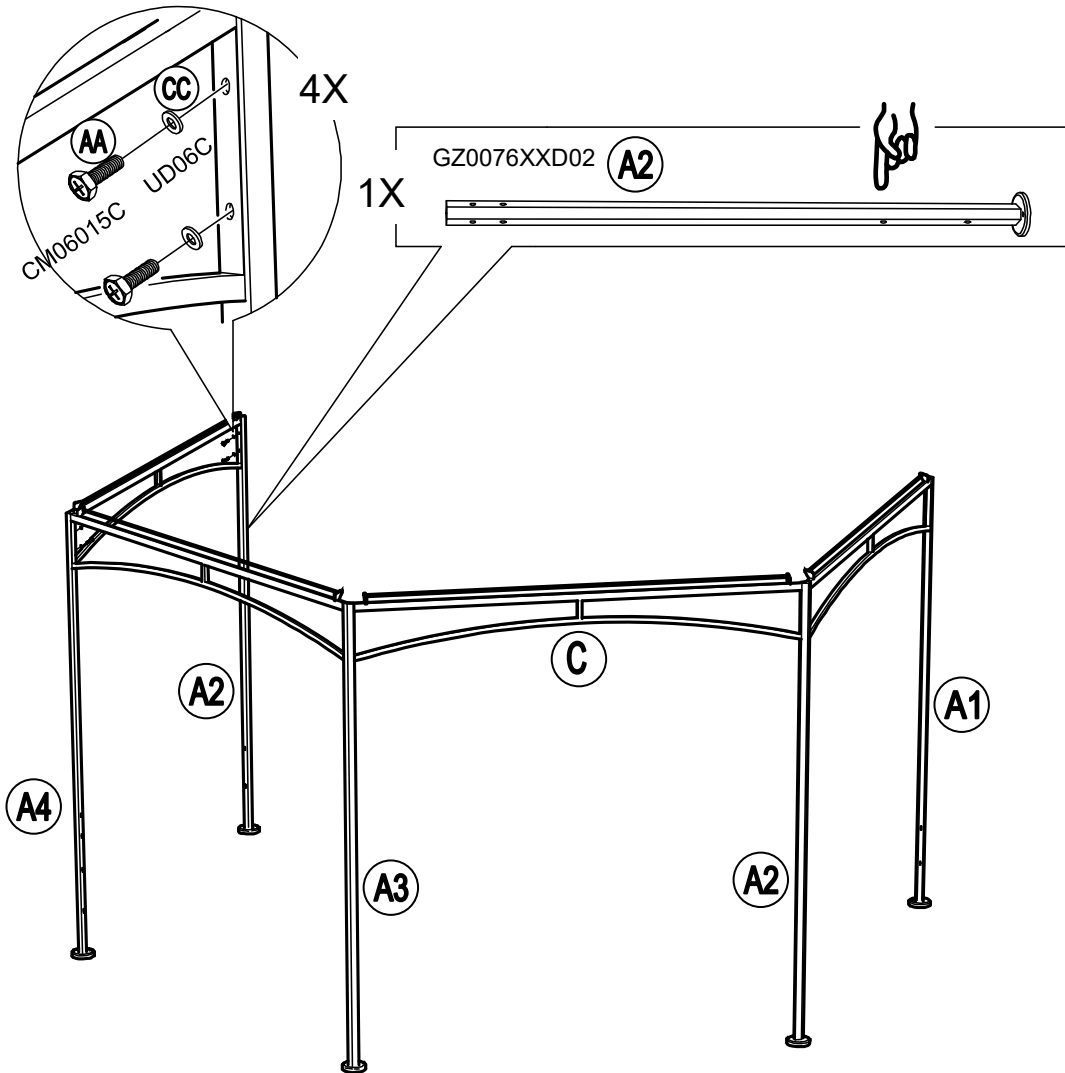
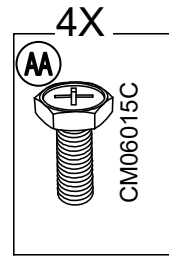
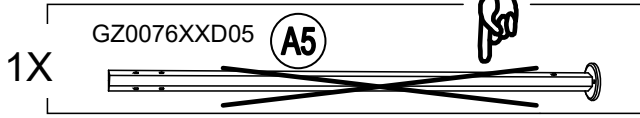
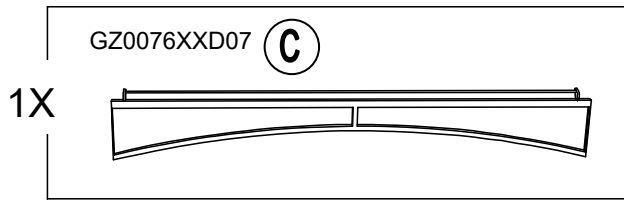

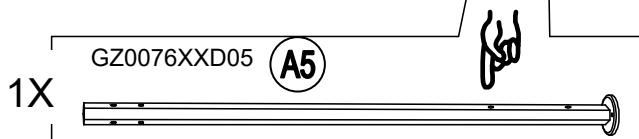
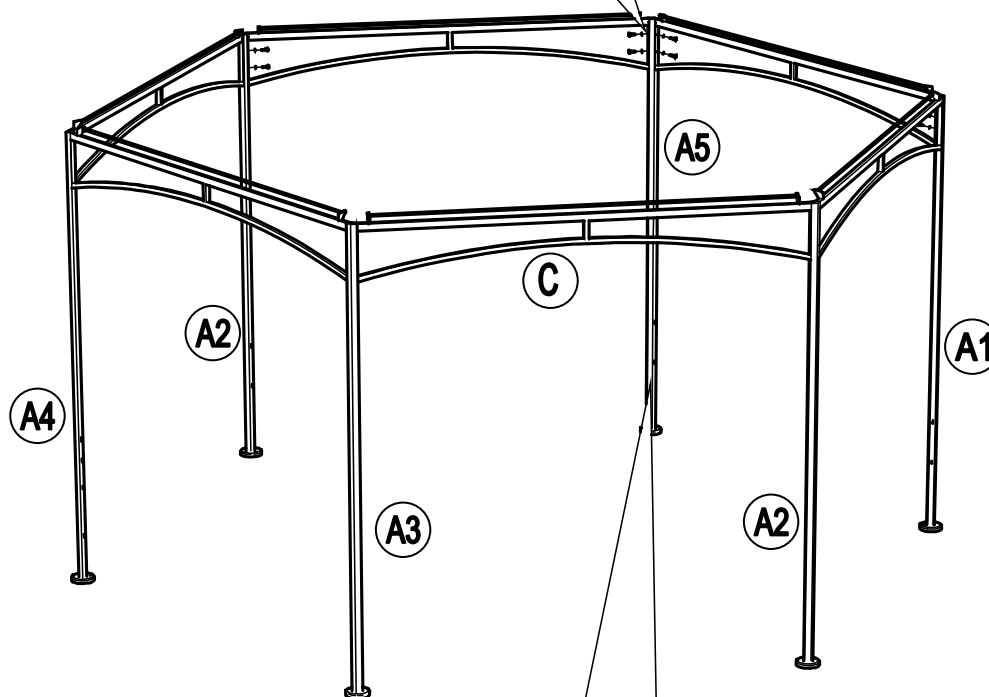
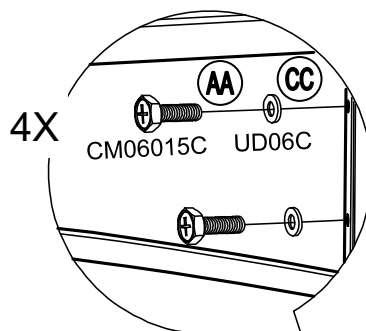
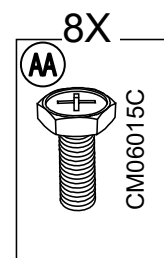
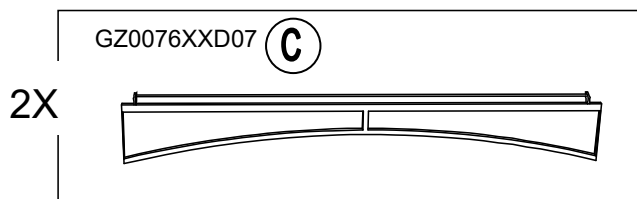

STEP 2: Assembly of Fence Panel

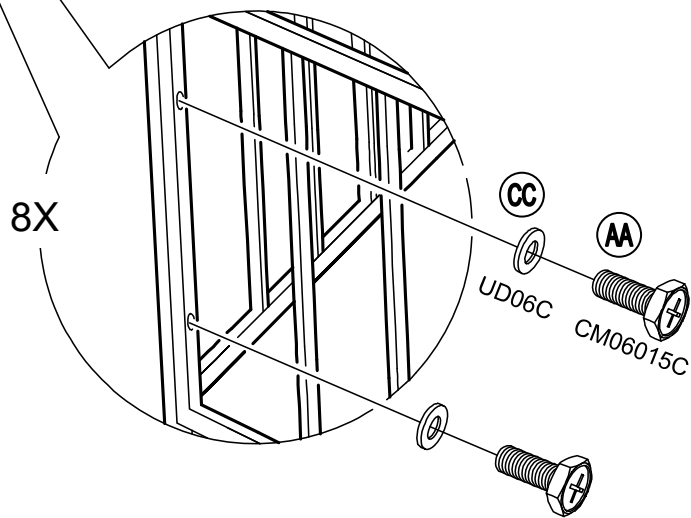
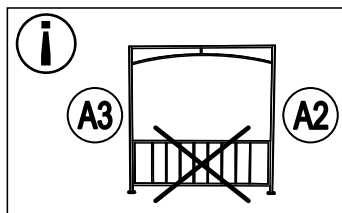
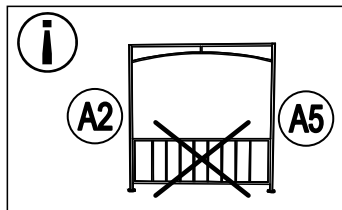
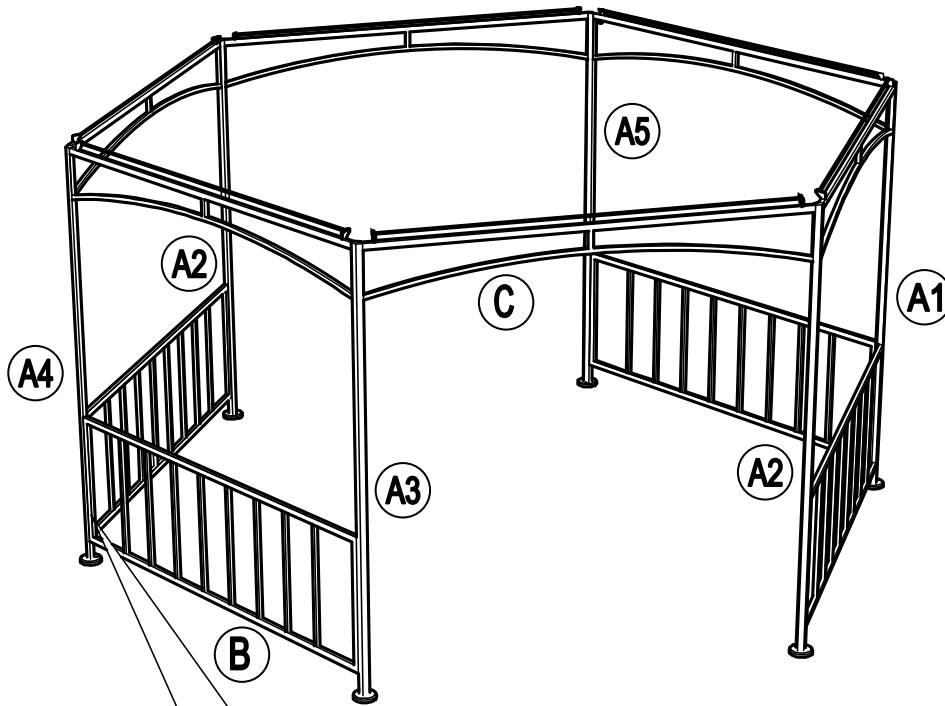
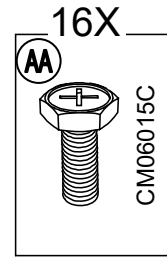
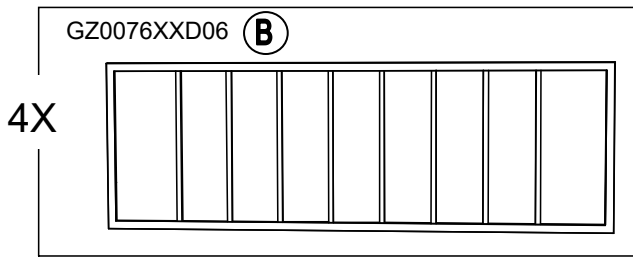

STEP 3: Assembly of Shelf

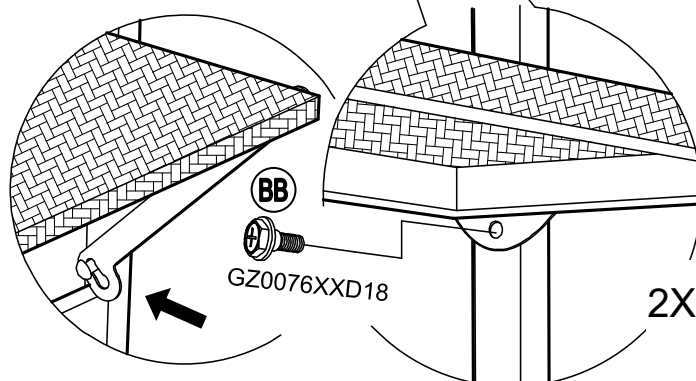
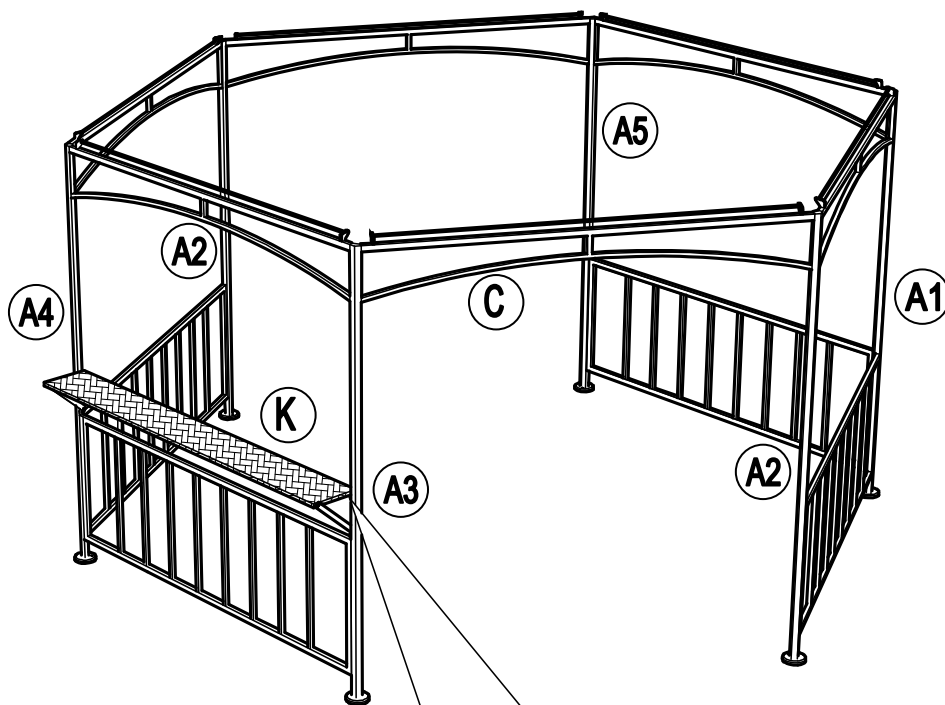
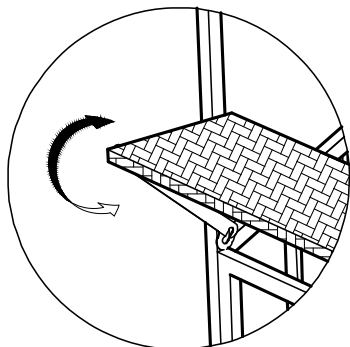
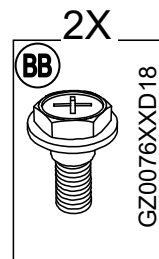
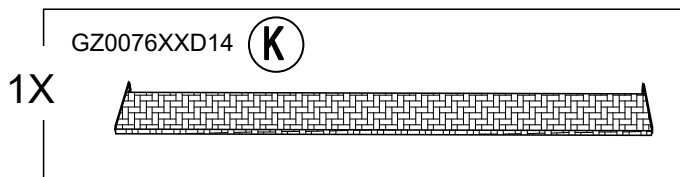

STEP 4: Assembly of Slant Beam End For Big Roof

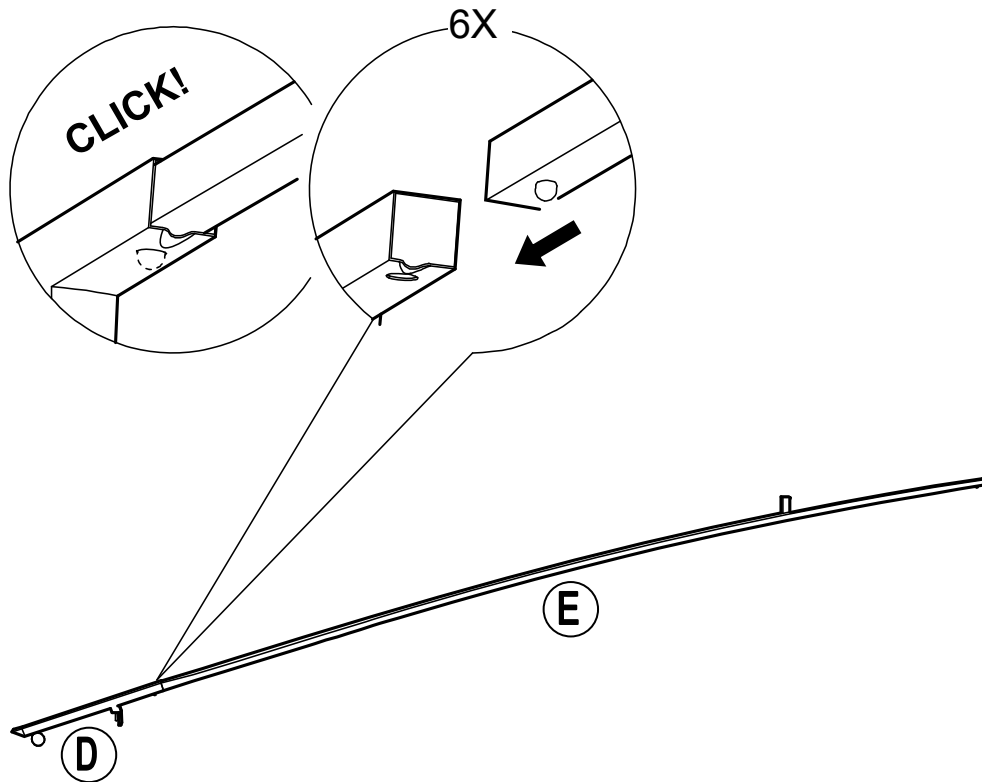
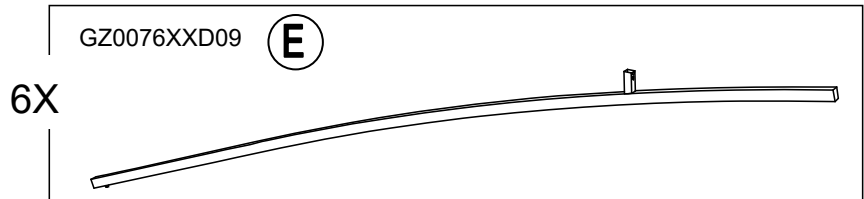
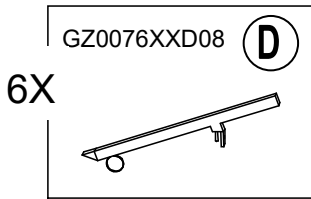

STEP 5: Assembly of Slant Beam For Big Roof

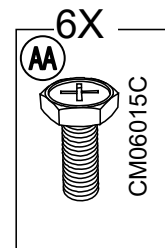
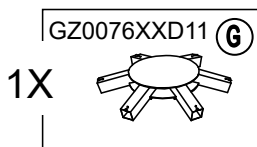

STEP 6: Assembly of Hook

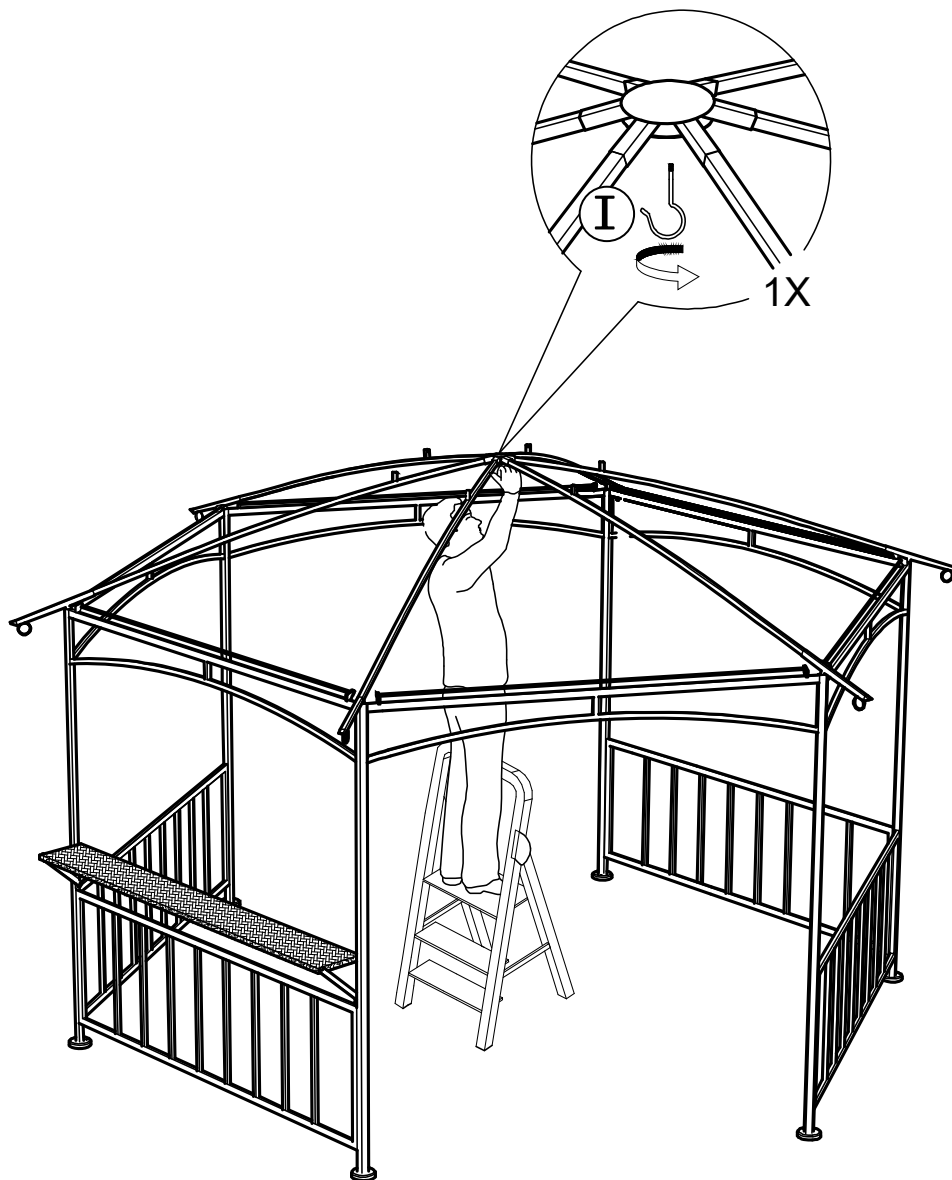
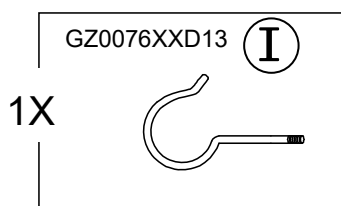

STEP 7: Put Large Canopy On Big Roof

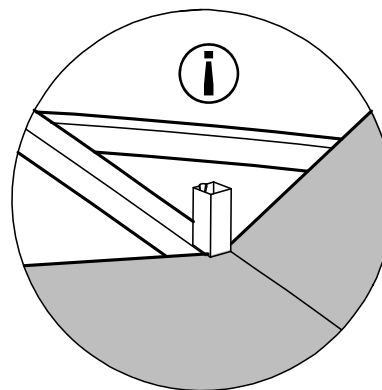
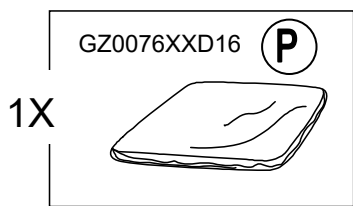

STEP 8: Assembly of Slant Beam For Small Roof

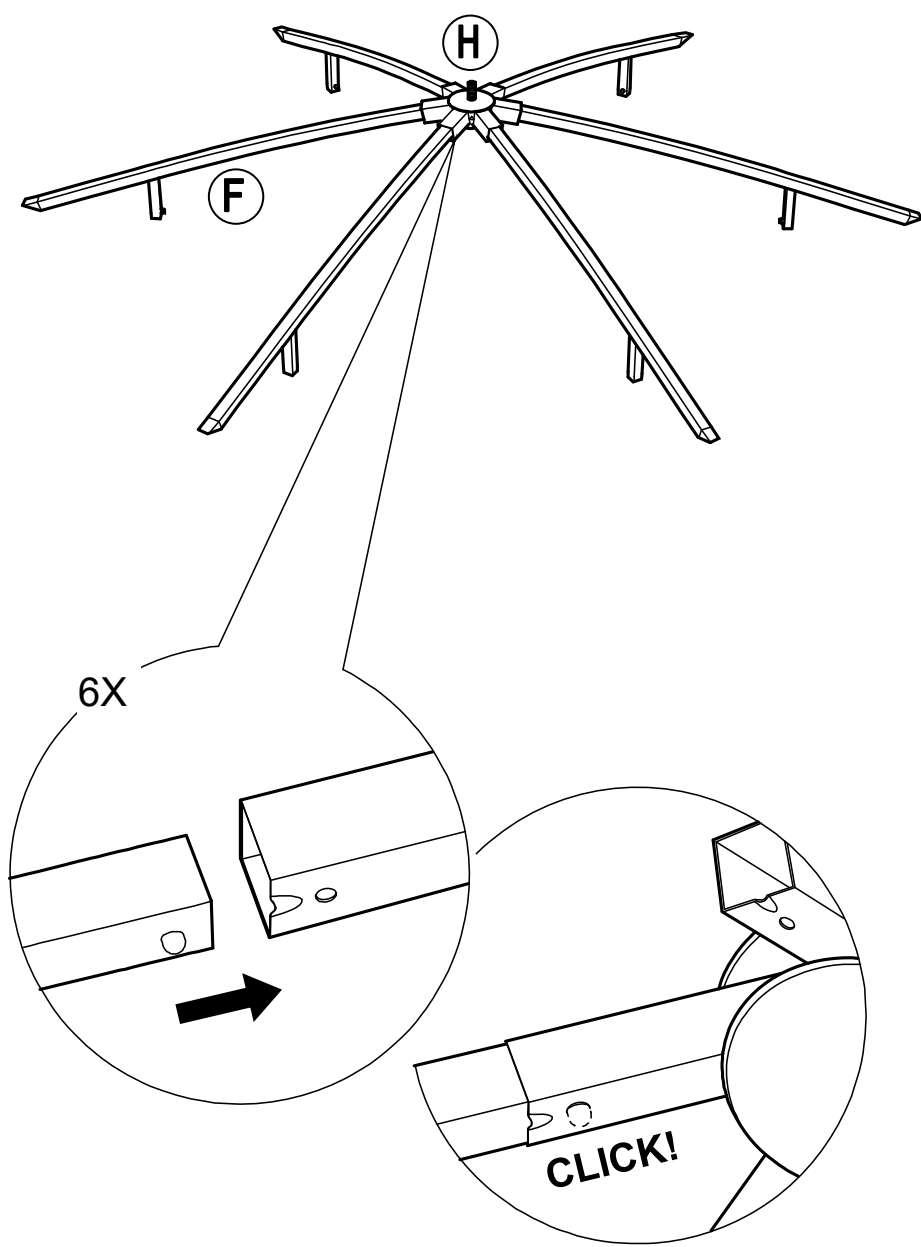
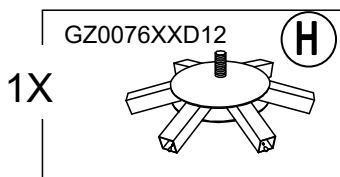
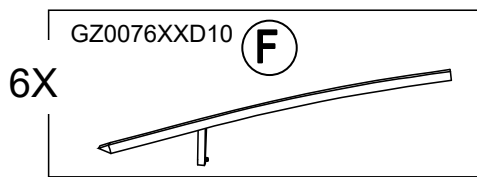

STEP 9: Assembly of Small Canopy And Finial

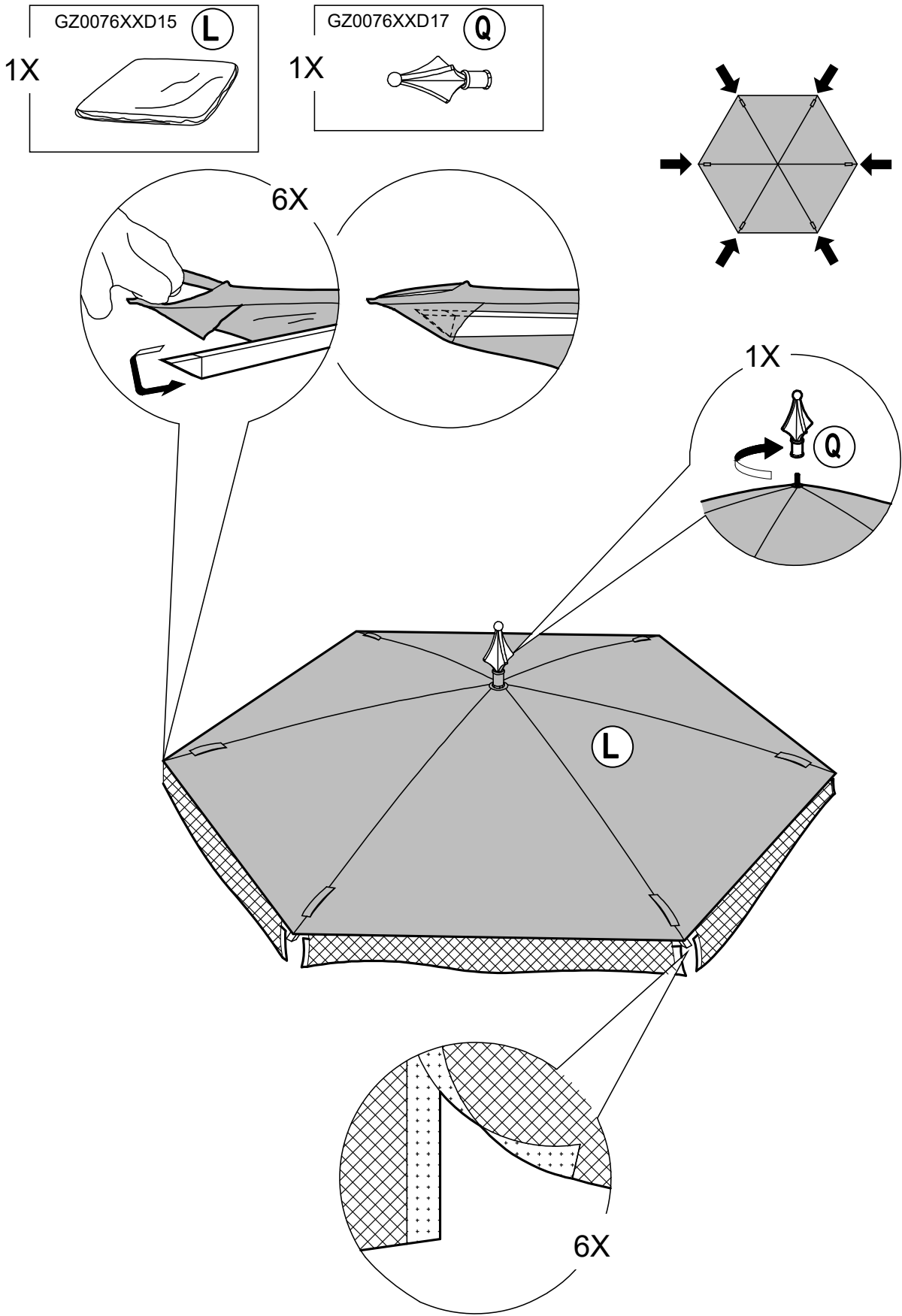

STEP 10: Assembly of Small Roof

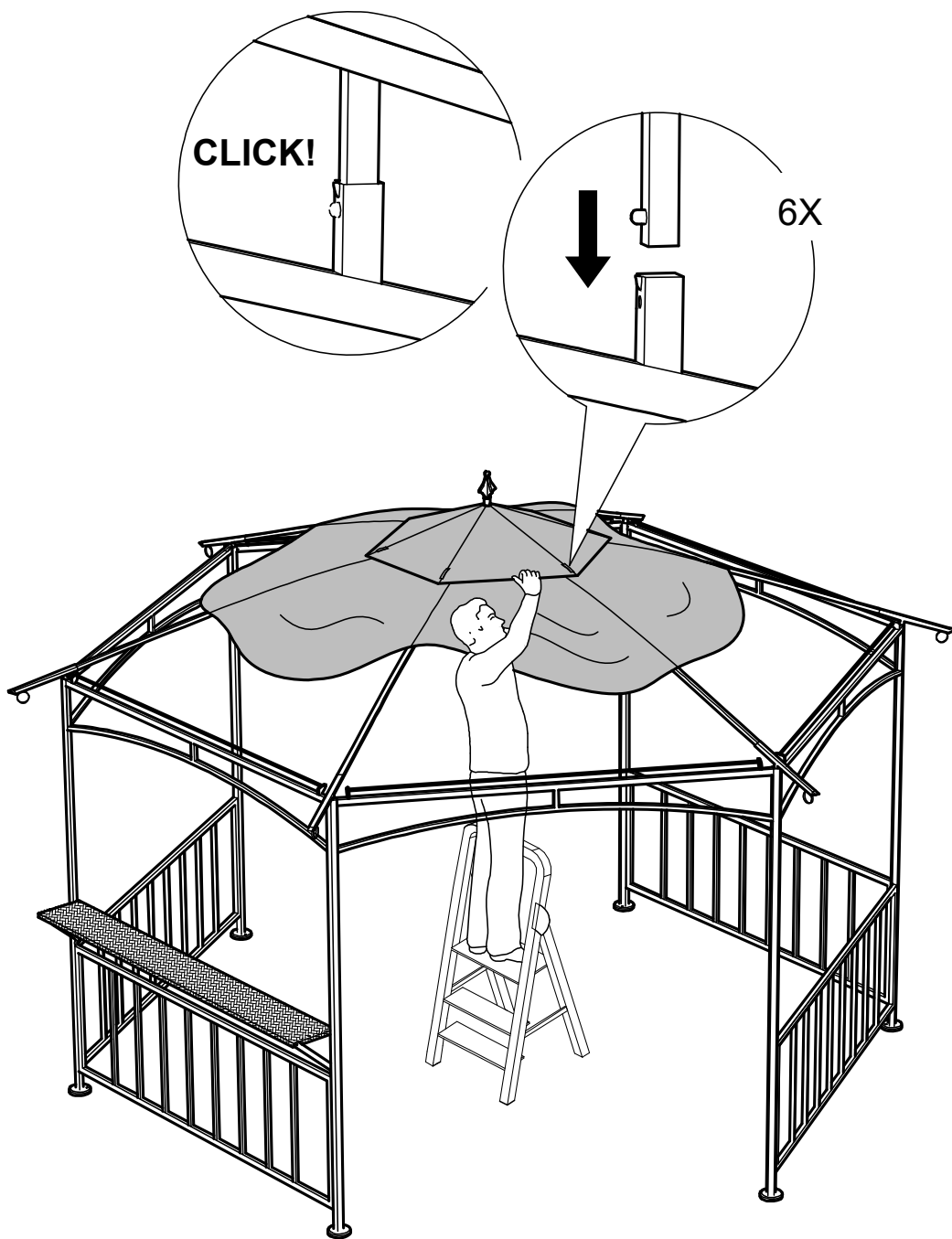

STEP 11: Assembly of Large Canopy

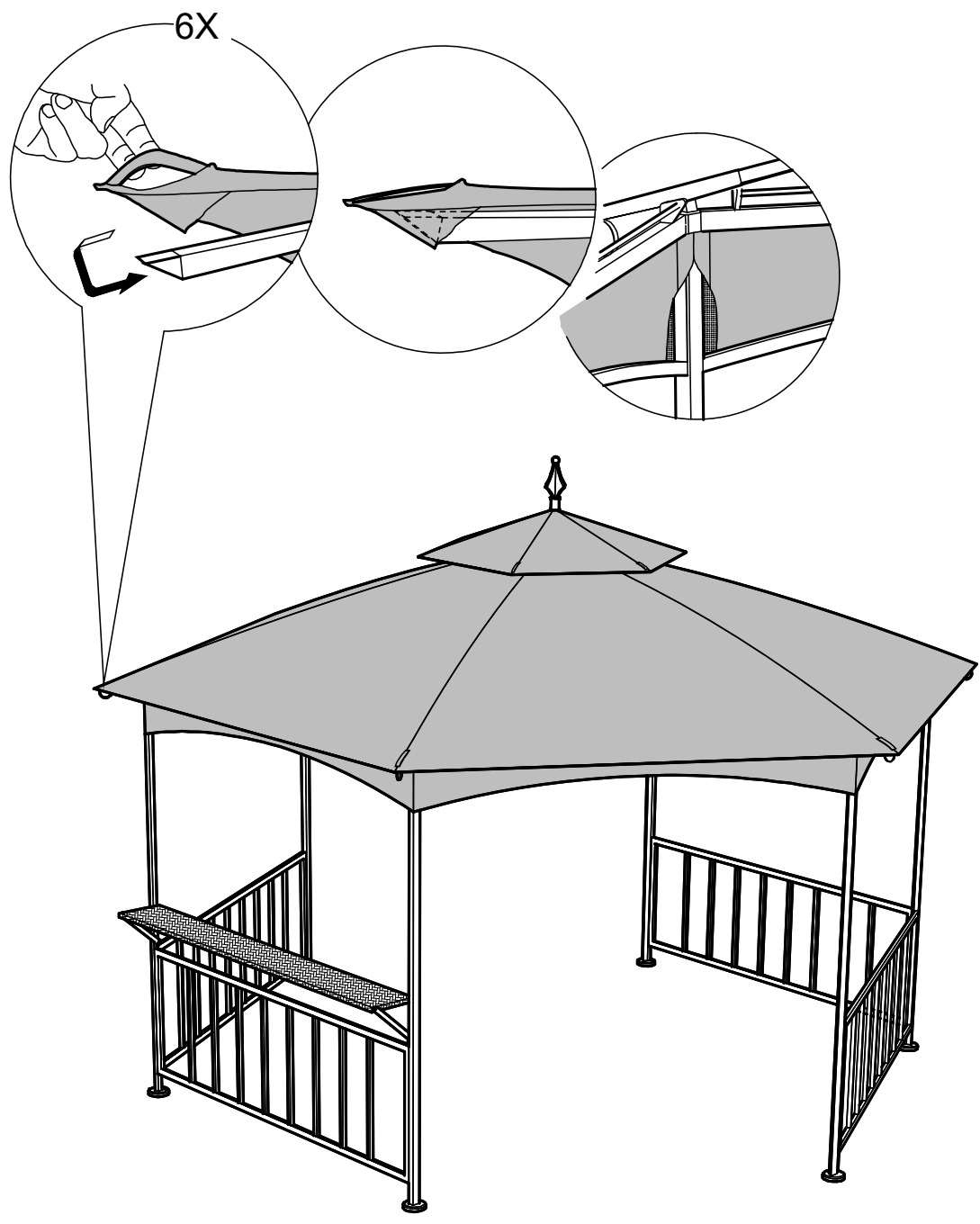

STEP 12: Assembly of Stake

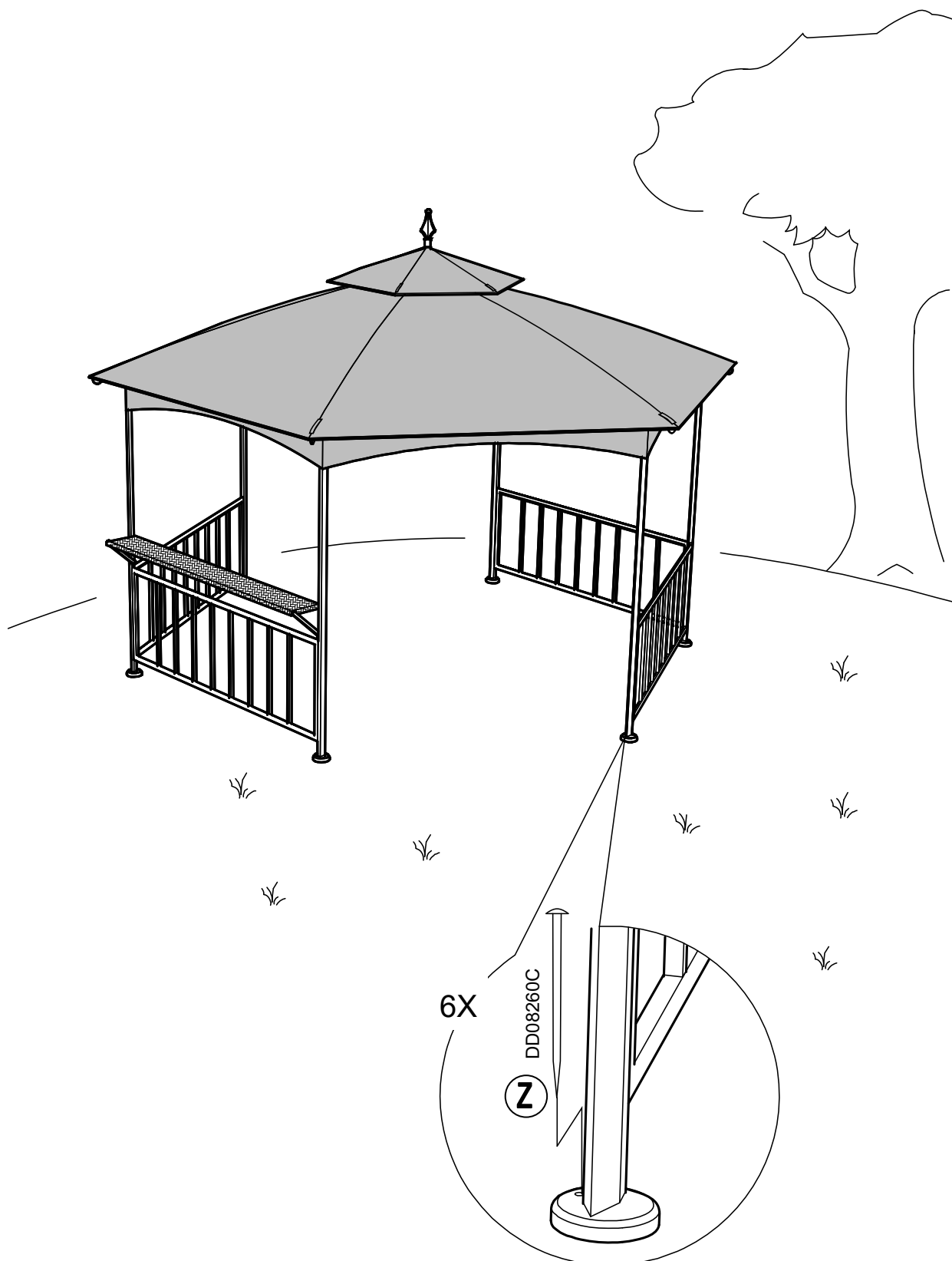

Country of Origin: CHINA

Call 1(866) 578-6569 for assistance.
Or visit us at www.sunjoyonline.com

Care and Maintenance

- Our steel components for garden accessories and furniture are treated with rust inhibiting paint that protects it from rusting. However, due to the nature of steel, surface oxidation (rusting) will occur once these protective coatings are scratched. This is not a defect and thus not covered by the warranty.
- To minimize this condition, we recommend care when assembling & handling the product to prevent scratching the paint. Should any scratching or damage occur, we recommend immediate touch-up with rust inhibiting paint.
- Surface rust can also be easily removed with a very light application of common cooking oil. If surface oxidation (rusting) occurs and if no measure is taken to prevent this, the oxidation may start dripping on to deck or patio and caused damaging stains, which may be difficult to remove. This can be prevented if the above-mentioned measures are taken to keep the product from oxidizing.
- Periodically check and ensure that all bolts are well-tighten during use

Limited Manufacturer's Warranty

Sunjoy Group warrants to the original purchaser that this item is free from defects in workmanship and materials for a period of **1 year** from the date of purchase, provided the item was factory-sealed at the time of purchase and is maintained with care and used only for personal, residential purposes. Should any manufacturing defect arise within this warranty period, Sunjoy Group will replace (at our option) any defective merchandise or parts upon proof of purchase; however, transportation and delivery costs, as well as payments to a third party for assembly or disassembly of the item, remain the responsibility of the purchaser. A purchaser of an "open box," previously-returned, or "clearance" item, as well as original purchasers outside of the warranty period, may obtain replacement parts from Sunjoy Group for products in current production, at nominal cost.

Exclusions:

Items used for commercial, contract, or other non-residential purposes, or items damaged due to acts of nature, vandalism, misuse, or improper assembly are not covered in the warranty. Corrosion or rusting of hardware is not covered. Proof of purchase (dated register receipt) is required for warranty claims. Warranty is to the original purchaser and is non-transferable. Any replacement of warranted items will be in the original style and color, or a similar style and color