



Chain Saw

Instruction Manual

MODELS : CS-352

WARNING **DANGER**



The muffler or catalytic muffler and surrounding cover may become extremely hot.

 Always keep clear of exhaust and muffler area, otherwise serious personal injury may occur.

WARNING

The engine exhaust from this product contains chemicals known to the State of California to cause cancer, birth defects or other reproductive harm.

WARNING

Users of this equipment risk injury to themselves and others if the unit is used improperly and/or safety precautions are not followed. ECHO provides an operator's manual and a safety manual. Both must be read and understood for proper and safe operation. Failure to do so could result in serious injury.

RULES FOR SAFE OPERATION

A. Kickback Safety Precautions for Chain Saw Users

WARNING!

KICKBACK may occur when the nose or tip of the guide bar touches an object, or when the wood closes in and pinches the saw chain in the cut.

Tip contact in some cases may cause a lightning fast reverse REACTION, Kicking the guide bar up and back towards the operator.

Pinching the saw chain along the top of the guide bar may push the guide bar rapidly back towards the operator.

Either of these reactions may cause you to lose control of the saw which could result in serious personal injury.

The Kick Guard® device is not installed on the guide bar when you purchase your ECHO chain saw.

The Kick Guard® can be used in a majority of cutting operations, and is especially recommended for beginners, homeowners, or chain saw novices.

Most cutting operations can be accomplished with the Kick Guard® in place.

Do not rely exclusively upon the safety devices built into your saw. As a chain saw user, you should take several steps to keep your cutting jobs free from accident or injury.

1. With a basic understanding of kickback, you can reduce or eliminate the element of surprise.
Sudden surprise contributes to accidents.
2. Keep a good firm grip on the saw with both hands, the right hand on the rear handle, and the left hand on the front handle, when the engine is running. Use a firm grip with thumbs and fingers encircling the chain saw handles.
A firm grip will help you reduce kickback and maintain control of the saw.
Don't let go.
3. Make sure that the area in which you are cutting is free from obstructions. Do not let the nose of the guide bar contact a log, branch, or any other obstruction which could be hit while you are operating the saw.
4. Cut at high engine speeds.
5. Do not overreach or cut above shoulder height.
6. Follow manufacturer's sharpening and maintenance instructions for the saw chain.
7. Only use replacement bars and chains specified by the manufacturer or the equivalent.

B. Other Safety Precautions

1. Do not operate a chain saw with one hand! Serious injury to the operator, helpers, bystanders, or any combination of these persons may result from one-handed operation. A chain saw is intended for two-handed use.
2. Do not operate a chain saw when you are fatigued.
3. Use safety footwear, snug-fitting clothing and protective gloves. Wear eye, hearing, and head protection devices.
4. Use caution when handling fuel. Move the chain saw at least 3 m (10 feet) from the fueling point before starting the engine.
5. Do not allow other persons to be near the chain saw when starting or cutting with the chain saw. Keep bystanders and animals out of the work area.
6. Do not start cutting until you have a clear work area, secure footing, and a planned retreat path from the falling tree.
7. Keep all parts of your body away from the saw chain when the engine is running.
8. Before you start the engine, make sure that the saw chain is not contacting anything.
9. Carry the chain saw with the engine stopped, the guide bar and saw chain to the rear, and the muffler away from your body. When carrying a chain saw with the engine running, push the front hand guard forward to engage the chain brake.
10. Do not operate a chain saw that is damaged, improperly adjusted, or not completely and securely assembled. Be sure that the saw chain stops moving when the throttle control trigger is released.
11. Shut off the engine before setting the chain saw down.
12. Use extreme caution when cutting small size brush and saplings because slender material may catch the saw chain and be whipped toward you or pull you off balance.
13. When cutting a limb that is under tension, be alert for spring-back so that you will not be struck when the tension in the wood fibers is released.
14. Keep the handles dry, clean, and free of oil or fuel mixture.
15. Operate the chain saw only in well ventilated areas.
16. Do not operate a chain saw in a tree unless you have been specifically trained to do so.
17. All chain saw service, other than items listed in the Instruction manual maintenance instructions, should be performed by competent service personnel. (For example, if improper tools are used to remove the flywheel or if an improper tool is used to hold the flywheel in order to remove the clutch, structural damage to the flywheel could occur and could subsequently cause the flywheel to burst.)
18. When transporting your chain saw, use the appropriate guide bar scabbard.
19. Spark arrestor mufflers approved to SAE Standard J335 are standard on ECHO chain saws to reduce the possibility of forest fires. Do not operate the chain saw with a loose or defective muffler. Do not remove the spark arrestor screen.

CONTENTS

RULES FOR SAFE OPERATION	2
SYMBOLS AND SIGNS	4
PACKING LIST	7
NOMENCLATURE OF PARTS	8
OPERATOR SAFETY	10
CORRECT USE OF CHAIN BRAKE	11
PREPARATION FOR USE	12
FUEL AND LUBRICANT	14
EMISSION DATA	16
OPERATION	16
CUTTING INSTRUCTION	19
CHAIN AND GUIDE BAR COMBINATION.....	24
MAINTENANCE AND CARE	25
- Carburetor Adjustment	26
- High Altitude Operation	26
SETTING THE SAW CHAIN	30
TROUBLESHOOTING	32
STORAGE AFTER USE.....	33
TECHNICAL DATA.....	33
WARRANTY STATEMENTS.....	34

This chain saw is designed for cutting wood or wood products. Do not cut solid metal, sheet metal, plastic or any non-wood materials.

Specifications, descriptions and illustrative material in this literature are as accurate as known at the time of publication, but are subject to change without notice.

Illustrations may include optional equipment and accessories, and may not include all standard equipment.

SYMBOLS AND SIGNS



DANGER

The safety alert symbol accompanied by the word “DANGER” calls attention to an act or condition which WILL lead to serious personal injury or death if not avoided.



CIRCLE AND SLASH SYMBOL

This symbol means the specific action shown is prohibited. Ignoring these prohibitions can result in serious or fatal injury.



WARNING

The safety alert symbol accompanied by the word “WARNING” calls attention to an act or condition which CAN lead to serious personal injury or death if not avoided.

NOTICE

This enclosed message provides tips for use, care and maintenance of the unit.







CAUTION

The safety alert symbol accompanied by the word “CAUTION” calls attention to an act or condition which may lead to minor or moderate personal injury if not avoided.

IMPORTANT

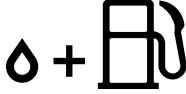
The enclosed message provides information necessary for the protection of the unit.

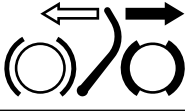
SYMBOL FORM

Symbol form/shape	Symbol description/application	Symbol form/shape	Symbol description/application
	WARNING!! Read and follow all safety precaution in the instruction manual		Oil and gasoline mixture
	Wear eye, ear, and head protection		Chain oil fill
	Chain brake operation	L	Carburetor adjustment - Low speed mixture
	Emergency stop	H	Carburetor adjustment - High speed mixture
	Choke control "Cold Start" position (choke closed)	T	Carburetor adjustment - Idle speed

DECALS

CS-352



WARNING!! Read and follow all safety precaution in the instruction manual. Failure to follow instructions could result in serious personal injury.

TO AVOID KICKBACK

1. Hold the chain saw firmly with both hands.
2. Don't let the nose of the guide bar contact any obstruction.
3. Tip contact may suddenly move the guide bar upward and backward, which may cause serious injury.

REPLACEMENT BAR AND CHAIN

	GUIDE BAR* PART NO.	CHAIN* PART NO.
12"	12A0CD3745	91VG45CQ / 91P45CQ
14"	14A0CD3752	91VG52CQ / 91P52CQ
16"	16A0CD3757	91VG57CQ / 91P57CQ

Note: There may be other replacement components for achieving kickback protection. For details, please refer to the chain and bar combination sheet shown in the instruction manual.

Locate these safety decals on your unit. The complete unit illustration found in the "NOMENCLATURE OF PARTS" section will help you locate them. Make sure the decal is legible and that you understand and follow the instructions on it. If a decal cannot be read, a new one can be ordered from your ECHO dealer.



WARNING

- During operation, the muffler or catalytic muffler and surrounding cover become hot.
- Never suspend the saw on a lanyard with the engine running.
- Always use the saw from the right-hand side of your body – **NEVER** from the left side.
- Always wear proper safety clothing to protect your lower body from sharp saw chain and hot muffler.
- Always keep exhaust area clear of flammable debris during transportation or when storing, otherwise serious property damage or personal injury may result.



WARNING

Moving parts can amputate fingers or cause severe injuries. Keep hands, clothing and loose objects away from all openings.

- **ALWAYS** stop engine, disconnect spark plug, and make sure all moving parts have come to a complete stop before removing obstructions, clearing debris, or servicing unit.
- **DO NOT** start or operate unit unless all guards and protective covers are properly assembled to unit.
- **NEVER** reach into any opening while the engine is running. Moving parts may not be visible through openings.



WARNING

Using improper replacement components or removing safety devices may result in serious or fatal injury.



WARNING

Check fuel system for leaks due to fuel tank damage, especially if the unit is dropped. If damage or leaks are found, do not use unit, otherwise serious personal injury or property damage may occur. Have unit repaired by an authorized servicing dealer before using.

PACKING LIST

The ECHO product you purchased has been factory pre-assembled for your convenience. Due to packaging restrictions, guide bar and saw chain installation and other assembly may be necessary.

After opening the carton, check for damage. Immediately notify your retailer or ECHO dealer of damaged or missing parts. Use the packing list to check for missing parts.

ECHO chain saw

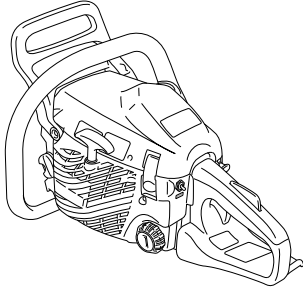

T-wrench



ECHO Power Blend X™ 2-stroke oil sample



Instruction manual

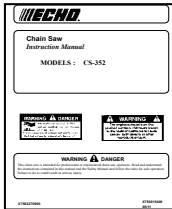

Safety manual



Guide bar



Kick Guard®



Saw chain



Warranty registration card

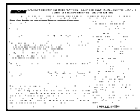

NOMENCLATURE OF PARTS

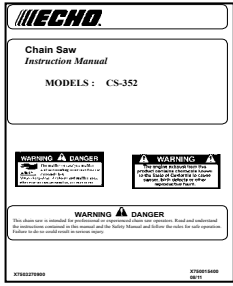

← 1



← 2

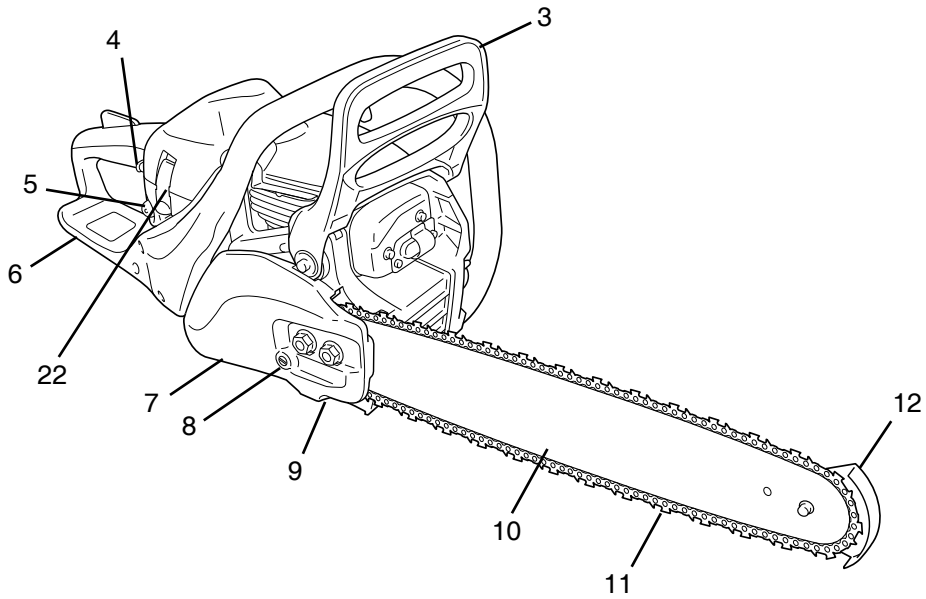

TO AVOID KICKBACK

1. Hold the chain saw firmly with both hands.
2. Don't let the nose of the guide bar contact any obstruction.
3. Tip contact may suddenly move the guide bar upward and backward, which may cause serious injury.

CS-352

WARNING!! Read and follow all safety precaution in the instruction manual. Failure to follow instructions could result in serious personal injury.

REPLACEMENT BAR AND CHAIN

GUIDE BAR*	CHAIN*
PART NO.	PART NO.
12" 12A0CD3745	91VG45CQ / 91P45CQ
14" 14A0CD3752	91VG52CQ / 91P52CQ
16" 16A0CD3757	91VG57CQ / 91P57CQ

Note: There may be other replacement components for achieving kickback protection. For details, please refer to the chain and bar combination sheet shown in the instruction manual.

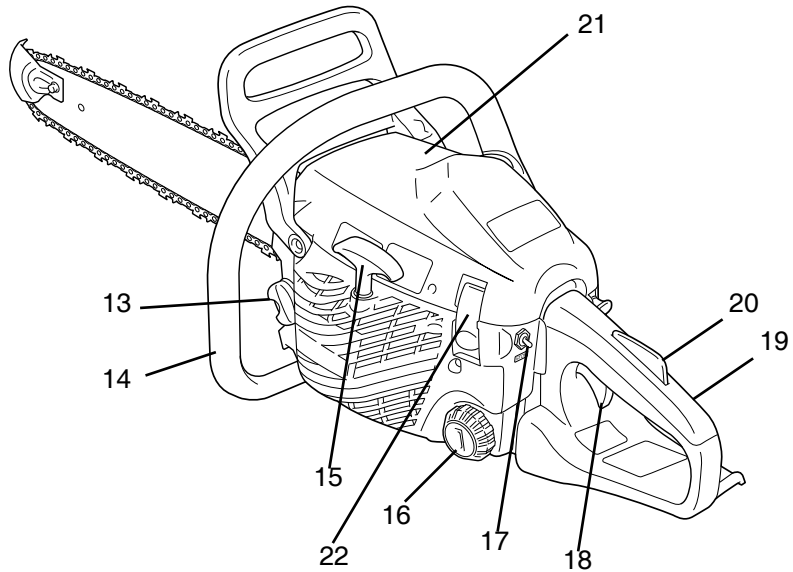

* If a decal cannot be read, a new one can be ordered from your ECHO dealer.

NOMENCLATURE OF PARTS

- 1. Instruction manual** - Included with unit. Read before operation and keep for future reference to learn proper, safe operating techniques.
- 2. Safety manual** - Describe operating and safety instructions for this chain saw.
- 3. Front hand guard** - Guard between the front handle and the saw chain for protecting the hand from injuries and aiding in control of the chain saw if the hand slips off the handle. This guard is used to lock the chain brake which is to stop the saw chain rotation.
- 4. Choke control knob** - Device for enriching the fuel/air mixture in the carburetor to aid cold starting.
- 5. Purge pump** - When starting engine, push purge pump 3 or 4 times.
- 6. Rear hand guard** - Extension on the lower part of the rear handle for protecting the hand from the chain if it breaks or degrooves.
- 7. Clutch cover** - Protective cover to the guide bar, saw chain, clutch and sprocket when the chain saw is in use.
- 8. Chain tension adjuster** - Device to adjust chain tension.
- 9. Chain catcher** - A projection designed to reduce the risk of the operator's right hand from being hit by a chain which has broken or derailed from the guide bar during cutting.
- 10. Guide bar** - The part that supports and guides the saw chain.
- 11. Saw chain** - Chain, serving as a cutting tool.
- 12. Bar tip guard** - Anti-kickback device attached on the bar nose.
- 13. Oil tank cap** - For closing the oil tank.
- 14. Front handle (for the left hand)** - Support handle located at the front of the engine housing.
- 15. Starter handle** - Pull handle slowly until starter engages then quickly and firmly. When engine starts, return handle slowly. DO NOT let handle snap back or damage to unit will occur.
- 16. Fuel tank cap** - For closing the fuel tank.
- 17. Ignition switch** - Device for connecting and disconnecting the ignition system and thus allowing the engine to be started or stopped.
- 18. Throttle trigger** - Device activated by the operator's finger, for controlling the engine speed.
- 19. Rear handle (for the right hand)** - Support handle located towards the rear of the engine housing.
- 20. Throttle trigger lockout** - A safety lever which must be depressed before the throttle trigger can be activated in order to prevent the accidental operation of the throttle trigger.
- 21. Cylinder cover** - The cooling airflow grill. It covers the cylinder, air filter, spark plug and silencer.
- 22. Cylinder cover latch** - Secures cylinder cover.

OPERATOR SAFETY

VIBRATION AND COLD

- It is believed that a condition called Raynaud's Phenomenon, which affects the fingers of certain individuals, may be brought about by exposure to vibration and cold.
Exposure to vibration and cold may cause tingling and burning followed by loss of color and numbness in the fingers.
The following precautions are strongly recommended because the minimum exposure which might trigger the ailment is unknown.
- Keep your body warm, especially the head and neck, feet and ankles and hands and wrists.
- Maintain good blood circulation by performing vigorous arm exercises during frequent work breaks and also by not smoking.
- Limit the number of hours of operation.
Try to fill each day with jobs where operating the chain saw, or other hand-held power equipment is not required.
- If you experience discomfort redness and swelling of the fingers, followed by whitening and loss of feeling, consult your physician before further exposing yourself to cold and vibration.

REPETITIVE STRESS INJURY

- It is believed that over-using the muscles and tendons of the finger, hands, arms and shoulders may cause soreness, swelling, numbness, weakness and extreme pain to the areas just mentioned.
Certain repetitive hand activities may put you at a high risk for developing a repetitive stress injury (RSI).
- An extreme RSI condition is Carpal Tunnel Syndrome (CTS) which could occur when your wrist swells and squeezes a vital nerve that runs through the area.
Some believe that prolonged exposure to vibration may contribute to CTS.
CTS can cause severe pain for months or even years.
To reduce the risk of RSI/CTS, do the following:
- Avoid using your wrist in a bent, extended or twisted position.
- Take periodic breaks to minimize repetition and rest your hands.
- Reduce the speed and force in which you do the repetitive movement.
- Do exercises to strengthen hand and arm muscles.
- See a doctor if you feel tingling, numbness or pain in your fingers, hands, wrists or arms. The sooner RSI/CTS is diagnosed, the more likely permanent nerve and muscle damage can be prevented.

EYE AND HEARING PROTECTION

- Wear eye protection goggles that meet ANSI Z 87.1 requirements.
Goggles meeting the requirements have the mark "Z 87" stamped on them.
- Wear hearing protection.
If this guideline is not followed, hearing loss can occur. ECHO recommends wearing hearing protection at all times.

WEAR PROPER CLOTHING

- Snug fitting durable clothing should be worn. Pants should have long legs, **DO NOT WEAR SHORTS**. Do not wear loose fitting clothing, scarves, neckties, jewelry or any item that may become tangled in surrounding growth or the chain saw itself.
- Wear shoes with non-skid soles.
DO NOT wear open toed shoes or operate unit barefooted.
- Wear no-slip, heavy duty work gloves to improve your grip on the chain saw handles.
The gloves also help reduce the transmission of machine vibration to your hands.

HOT HUMID WEATHER

- Heavy protective clothing can increase operator fatigue which may lead to heat stroke.
Schedule heavy work for early morning, or late afternoon hours when temperatures are cooler.

AVOID HOT SURFACES

- During operation, the muffler or catalytic muffler and surrounding cover become hot.
- Never suspend the saw on a lanyard with the engine running.
- Always use the saw from the right-hand side of your body - **NEVER** from the left side.
- Always wear proper safety clothing to protect your lower body from sharp saw chain and hot muffler.
- Always keep exhaust area clear of flammable debris during transportation or when storing, otherwise serious property damage or personal injury may result.

SPARK ARRESTOR MUFFLER

- The spark arrestor muffler controls the exhaust noise and prevents hot, glowing particles of carbon from leaving the muffler. Make sure the spark arrestor screen is in good repair and properly seated in the muffler.
- Certain internal combustion engines operated on forest, brush, and/or grass-covered areas in the states of Washington, Oregon, Idaho, California, Minnesota, New Jersey and Maine, are required to be equipped with a spark arrestor.

This requirement also applies to all U.S. Forest Service lands.

In some of these areas, the spark arrestor system must be certified per USDA Forest Service Regulation SAE J335.

Check with your local or state authorities for specific regulations in your area.

Failure to follow these requirements is a violation of the law.

CORRECT USE OF CHAIN BRAKE

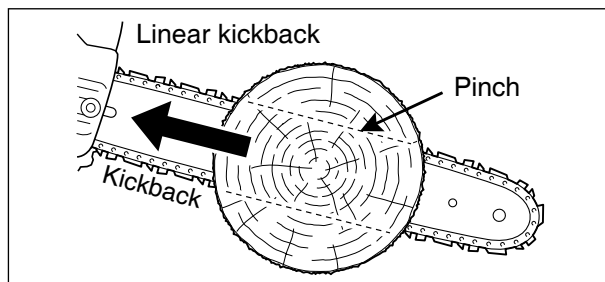
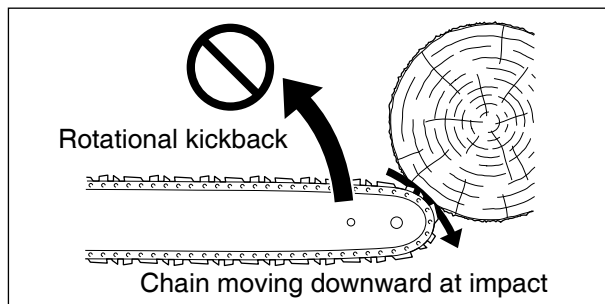
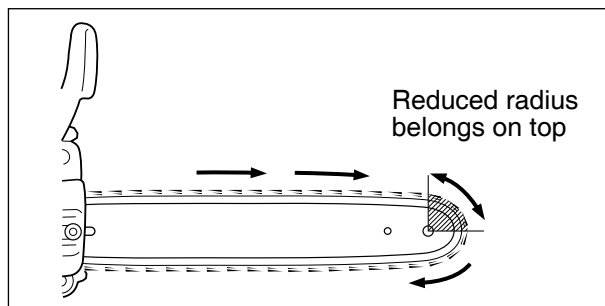
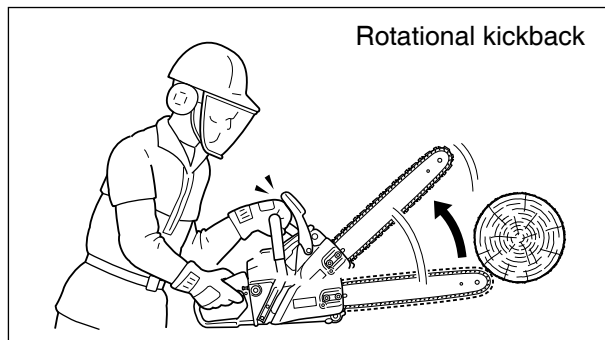

⚠ DANGER

Kickback safety precaution for chain saw users: Kickback may occur when the nose or tip of the guide bar touches an object or when the wood closes in and pinches the saw chain in the cut.

The installation of a chain brake may be mandatory by law or as stipulated by insurance regulations in your area of operation.

You should inquire through local government offices, your employer or your local dealer to ensure that your chain saw conforms to the required safety standard.

ECHO chain brakes have been designed and tested to comply with international safety standards as follows.

This model needs to use low-kickback chain and bar.

Do not use a combination other than those specified on page 22.

For your own safety, do not remove the chain brake system.

USA : ANSI Standard B175.1 - 2000

Safety Requirement for chain saws

Canada : CSA Standard Z 62.1 CHAIN SAWS

⚠ WARNING

ANSI Standard B175.1 - 2000 stipulates that the brake shall stop the chain 0.12 seconds at an engine speed of 13500 r/min.

It is the responsibility of the owner/operator to ensure that the brake is serviced, adjusted and tested strictly in accordance with the instructions as detailed herein in order to ensure that the brake performance is maintained in compliance with the Standard B175.1 - 2000.

PREPARATION FOR USE

WARNING

Saw chain is sharp! Always wear gloves when handling assembly, otherwise serious personal injury may result.

KICK GUARD® TO BAR INSTRUCTIONS

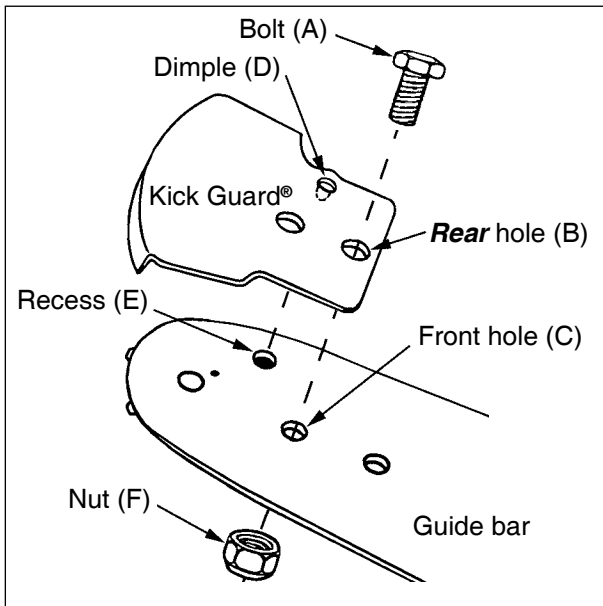

1. Install bolt (A) in **rear** hole (B) of Kick Guard® and through front hole (C) in guide bar.
2. **IMPORTANT:** Dimple (D) in Kick Guard® must engage recess (E) in guide bar.
3. Tighten nut (F) and bolt (A) using 11 mm (7/16 in.) wrenches until snug. Make certain Kick Guard® is flush against guide bar.
4. Tighten nut (F) 1/8 additional turn.
5. Check to make certain Kick Guard® is tight on guide bar.

GUIDE BAR AND SAW CHAIN INSTALLATION/REMOVAL

1. Remove spark plug lead. (See page 25)
2. Remove two clutch cover nuts and remove clutch cover.
3. Remove bar and saw chain if necessary. See "Maintenance and Care" section for guide bar/saw chain maintenance procedures.

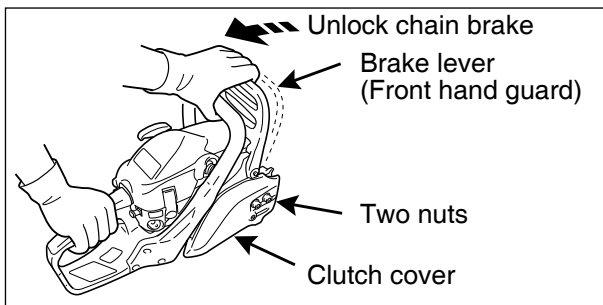

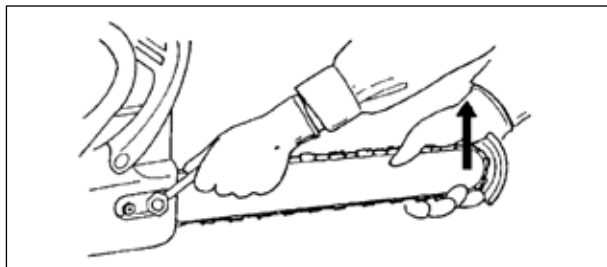
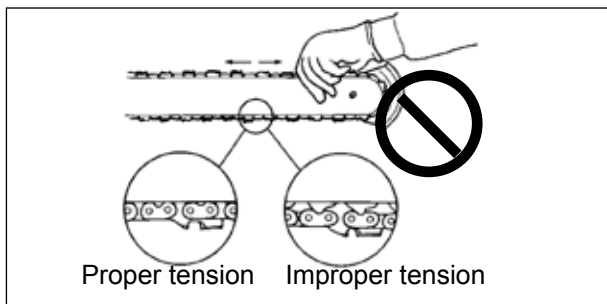
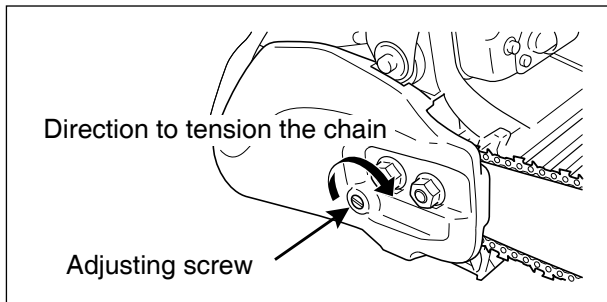
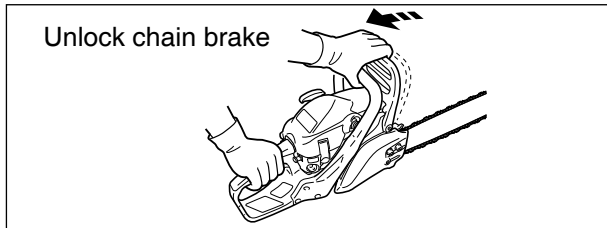
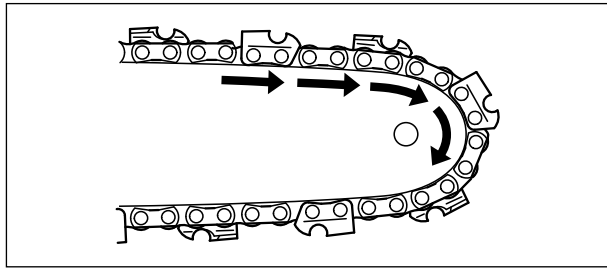
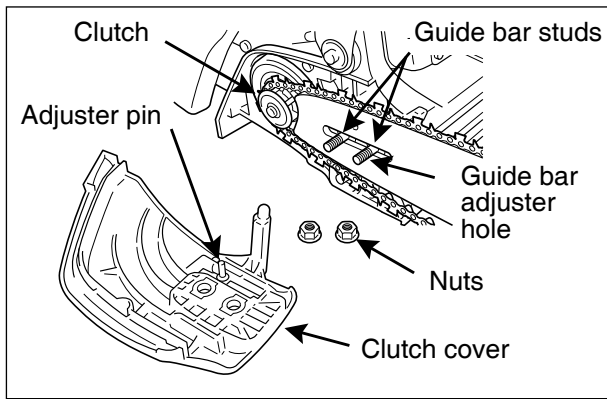

4. Unlock the chain brake, and mount guide bar on studs and slide toward clutch to make saw chain installation easier. Install chain with cutters on top of guide bar facing forward.

5. Install the clutch cover over the guide bar studs. Ensure chain tension adjuster pin fits into the guide bar adjuster hole. Tighten clutch cover nuts finger tight.

ADJUSTING CHAIN TENSION

IMPORTANT

Always loosen clutch cover nuts before turning the chain tension adjuster, otherwise the clutch cover and tensioner will be damaged.

1. Remove spark plug lead. (See page 25)
2. Unlock chain brake and loosen two clutch cover nuts, if necessary.
3. Hold the bar nose up, and turn the adjuster screw clockwise until chain fits snugly against underside of the bar.
4. Tighten both nuts with the bar nose held up.
5. Pull the chain around the bar by hand. Loosen the adjustment if you feel tight spots.
6. When chain is properly tensioned, tighten clutch cover nuts securely - 20 to 23 N·m (175 to 200 in. lb.).
7. Keep chain properly tensioned at all times.

FUEL AND LUBRICANT

WARNING

Alternative fuels, such as E-15 (15 % ethanol), E-85 (85 % ethanol) or any fuels not meeting ECHO requirements are NOT approved for use in ECHO 2-stroke gasoline engines.

Use of alternative fuels may cause performance problems, loss of power, overheating, fuel vapor lock, and unintended machine operation, including, but not limited to, improper clutch engagement.

Alternative fuels may also cause premature deterioration of fuel lines, gaskets, carburetor and other engine components.

Fuel Mix Chart 50 : 1

US.		METRIC	
Gasoline	Oil	Gasoline	Oil
Gallons	US. fl. oz.	L	mL
1	2.6	4	80
2	5.2	8	160
5	13	20	400

IMPORTANT

- ECHO premium Power Blend X™ Universal 2-Stroke Oil may be mixed at 50 : 1 ratio for application in all ECHO engines sold in the past regardless of ratio specified in those manuals.
- Use of unmixed, improperly mixed, or fuel older than 90 days, (stale fuel), may cause hard starting, poor performance, or severe engine damage and void the product warranty. Read and follow instructions in the Storage section of this manual.

FUEL STATEMENT

GASOLINE - Use 89 Octane [(R+M)/2] (mid grade or higher) gasoline or gasohol known to be good quality. Gasohol may contain up to 10 % Ethyl (grain) alcohol or 15 % MTBE (methyl tertiary-butyl ether). Gasohol containing methyl (wood) alcohol is **NOT** approved.

TWO-STROKE OIL - A two-stroke engine oil meeting ISO-L-EGD (ISO/CD 13738) and JASO M345-FD Standards must be used. ECHO brand premium Power Blend X™ Universal 2-Stroke Oil meets these standards. Engine problems due to inadequate lubrication caused by failure to use an ISO-L-EGD (ISO/CD 13738) and JASO M345-FD certified oil, such as ECHO premium Power Blend X™, will void the two-stroke engine warranty.

⚠ DANGER

Fuel is **VERY** flammable. Use extreme care when mixing, storing or handling or serious personal injury may result.

- Use an approved fuel container.
- **DO NOT** smoke near fuel.
- **DO NOT** allow flames or sparks near fuel.
- Fuel tanks/cans may be under pressure. Always loosen fuel caps slowly allowing pressure to equalize.
- **NEVER** refuel a unit when the engine is **HOT!**
- **NEVER** refuel a unit with the engine running.
- **DO NOT** fill fuel tanks indoors. **ALWAYS** fill fuel tanks outdoors over bare ground.
- Securely tighten fuel cap after refueling.
- Inspect for fuel leakage. If fuel leakage is found, do not start or operate unit until leakage is repaired.
- Move at least 3 m (10 feet) from refueling location before starting the engine.

HANDLING FUEL

MIXING INSTRUCTIONS -

1. Fill an approved fuel container with half of the required amount of gasoline.
2. Add the proper amount of two-stroke oil to gasoline.
3. Close container and shake to mix oil with gasoline.
4. Add remaining gasoline, close fuel container, and re-mix.

IMPORTANT

- Spilled fuel is a leading cause of hydrocarbon emissions. Some states may require the use of automatic fuel shut-off containers to reduce fuel spillage.
- Stored fuel ages. Do not mix more fuel than you expect to use in thirty (30) days, ninety (90) days when a fuel stabilizer is added.
- Stored two-stroke fuel may separate. **ALWAYS** shake fuel container thoroughly before each use.

AFTER USE -

DO NOT store a unit with fuel in its tank. Leaks can occur. Return unused fuel to an approved fuel storage container.

STORAGE -

Fuel storage laws vary by locality. Contact your local government for the laws affecting your area. As a precaution, store fuel in an approved, airtight container. Store in a well-ventilated, unoccupied building, away from sparks and flames.

Cap indication

Oil/fuel tanks are indicated by the following illustrations.

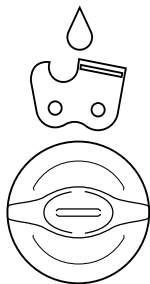

Oil tank cap

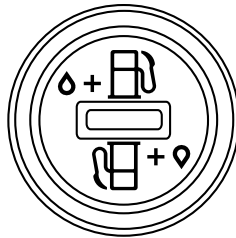

Fuel tank cap

CHAIN LUBRICANT

Proper lubrication of the chain while in operation reduces friction between the chain and the guide bar to a minimum and assures a longer service life.

- Use bar and chain oil of high quality for this purpose.
- Do not use used or reclaimed oil to avoid various oiler problems.
- Use ECHO bar and chain oil.
- When ECHO bar and chain oil is not available: Use motor oil, etc.
- Use bar and chain oil of the following grades:
SAE No. 30..... in summer
SAE No. 10..... in winter or when cutting resinous trees.
- When refueling, also refill chain oil.

EMISSION DATA

EMISSION CONTROL (EXHAUST & EVAPORATIVE)

EPA Phase 2 / C.A.R.B. TIER III

The emission control system for the engine is EM/TWC (Engine Modification and 3-way Catalyst) and for the fuel tank the Control System is EVAP (Evaporative Emissions) or N (for nylon tank). Evaporative emission may be applicable to California models only.

EMISSION CONTROL INFORMATION
ENGINE FAMILY: EHXS.0214KG DISPLACEMENT: 21.2cc
EMISSION COMPLIANCE PERIOD = 300 HOURS
THIS ENGINE MEETS **** U.S. EPA EXH/EVP AND CALIFORNIA
EXH AND EVP EMISSION REGULATIONS FOR S.O.R.E.
REFER TO OWNER'S MANUAL FOR MAINTENANCE
SPECIFICATIONS AND ADJUSTMENTS.
YAMABIKO CORP.  **** 

An Emission Control Label is located on the engine. (This is an EXAMPLE ONLY, information on label varies by engine FAMILY).

EMISSION CONTROL INFORMATION
ENGINE FAMILY: EHXS.0454KA DISPLACEMENT: 45.0cc
EMISSION COMPLIANCE PERIOD = 300 HOURS
THIS ENGINE MEETS U.S. EPA EXH/EVP REGS FOR MODEL YEAR 
REFER TO OWNER'S MANUAL FOR MAINTENANCE
SPECIFICATIONS AND ADJUSTMENTS.
YAMABIKO CORP.  **** 

PRODUCT EMISSION DURABILITY (EMISSION COMPLIANCE PERIOD)

The 300 hour emission compliance period is the time span selected by the manufacturer certifying the engine emissions output meets applicable emissions regulations, provided that approved maintenance procedures are followed as listed in the Maintenance Section of this manual.

OPERATION



WARNING

Moving parts can amputate fingers or cause severe injuries. Keep hands, clothing and loose objects away from all openings. Always stop engine, disconnect spark plug, and make sure all moving parts have come to a complete stop before removing obstructions, clearing debris, or servicing unit.



WARNING

Engine exhaust IS HOT, and contains Carbon Monoxide (CO), a poison gas. Breathing CO can cause unconsciousness, serious injury, or death. Exhaust can cause serious burns. ALWAYS position unit so that exhaust is directed away from your face and body.



WARNING

Operation of this equipment may create sparks that can start fires around dry vegetation. This unit is equipped with a spark arrestor and a spark arrestor may be required. The operator should contact local fire agencies for laws or regulations relating to fire prevention requirements.

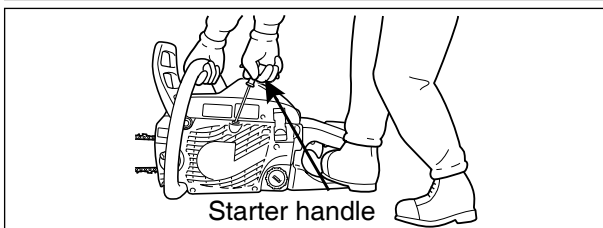
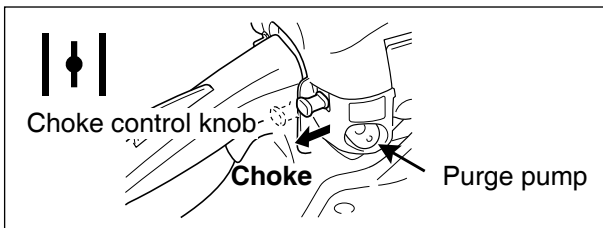
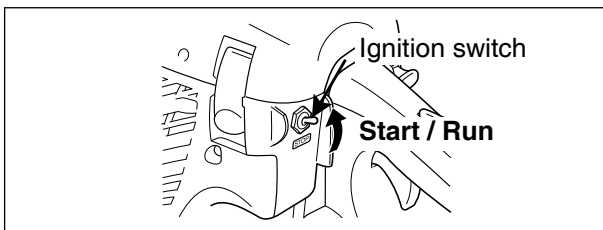
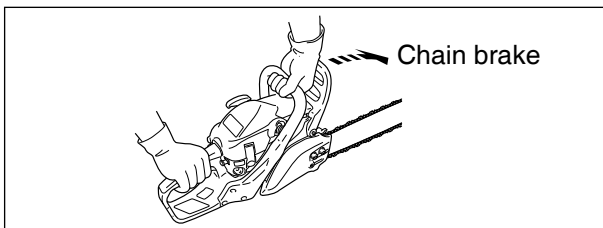
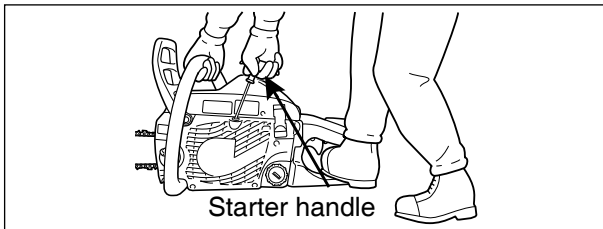
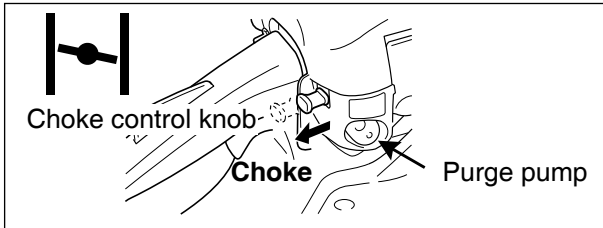
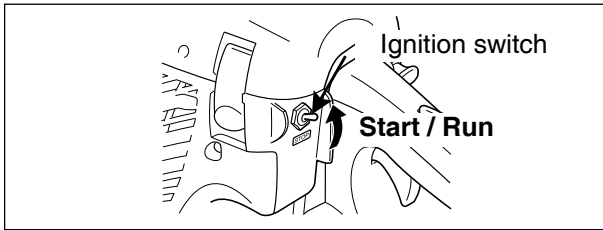
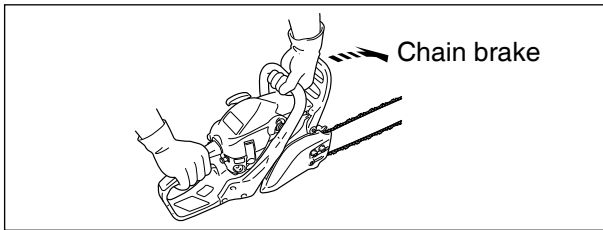

⚠ WARNING

- After choke control knob is pulled and then knob is returned to original position, throttle remains a little open (latch condition).
- If engine is started in this latch condition, chain starts to turn. Do not start engine before chain brake is activated.

⚠ CAUTION

- After starting the engine, squeeze throttle trigger slightly to release throttle latch and pull front hand guard towards the operator immediately. (Chain brake unlocked position)
- Never use throttle latch for cutting.

WHEN THE ENGINE IS COLD

⚠ CAUTION

Make sure the bar and chain are free from any obstruction when starting the chain saw.

- Move chain brake lever fully forward to lock chain brake before starting.
- Fill the fuel tank with fuel mixture. It is not permitted to fill fuel above the shoulder level of fuel tank.
- Fill the chain oil tank with lubricant. Do not over fill.
- Move ignition switch to "RUN" position.
- Push purge pump 3 to 4 times or until fuel is visible in purge pump.
- Pull choke control knob all the way out. (Choke position)
- Securely hold the chain saw as shown and pull starter handle several times until first firing sound.
- Push choke control knob all the way in.
- Pull starter handle to start the engine.
- When engine starts, immediately squeeze throttle trigger, to release throttle latch.

WHEN THE ENGINE IS WARM

CAUTION

Make sure the bar and chain are free from any obstruction when starting the chain saw.

- Move chain brake lever fully forward to lock chain brake before starting.
- Confirm there is fuel and chain oil in the tanks.
- Move ignition switch to “RUN” position.
- Securely hold the chain saw as shown and pull starter handle.
- Choke may be used if necessary, but after first firing sound, pull throttle trigger to release choke.

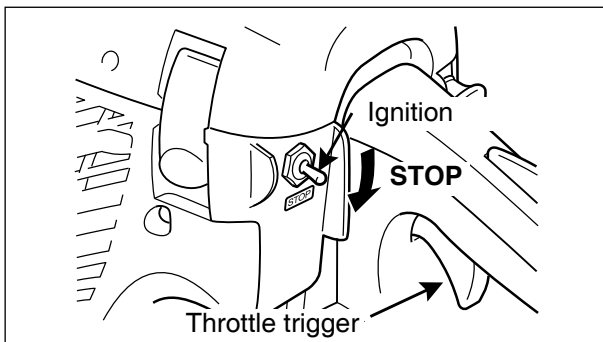
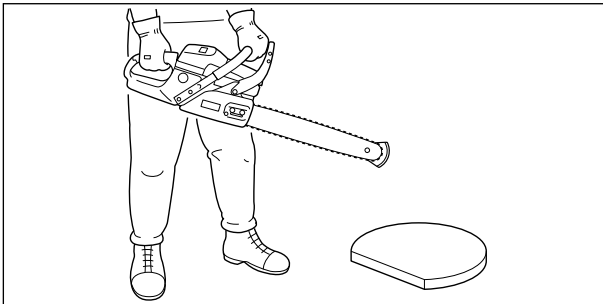
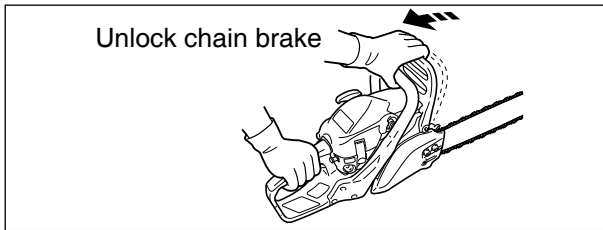
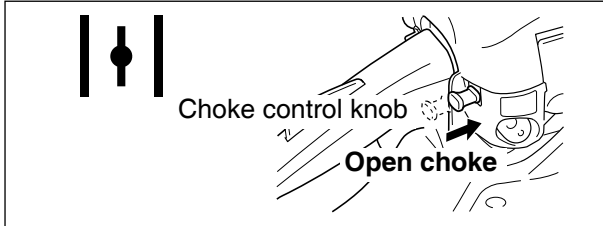
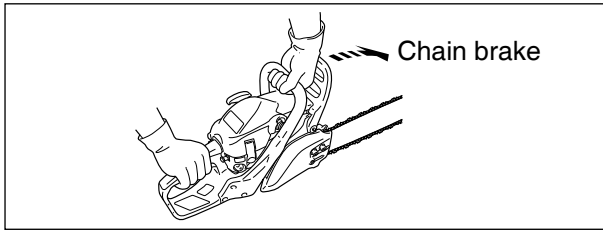

RUNNING

- When engine starts, keep idling for a few minutes.
- Set the brake lever in the unlocked position before starting to cut.
- Pull throttle trigger gradually and increase revolution of the engine.
- The chain starts running when the engine reaches 4300 r/min approximately.
- Confirm proper acceleration and lubrication of chain and bar. (**Non-adjustable automatic oil pump**)
- Do not run the engine at high speed unnecessarily.
- Be sure that saw chain stops moving when throttle trigger is released.

STOPPING

- Release throttle trigger and move ignition switch down to “STOP” position.

NOTICE

If engine does not stop, pull choke control knob out fully to stop engine.

Return the unit to your authorized ECHO dealer to check and repair stop switch before starting the engine again.

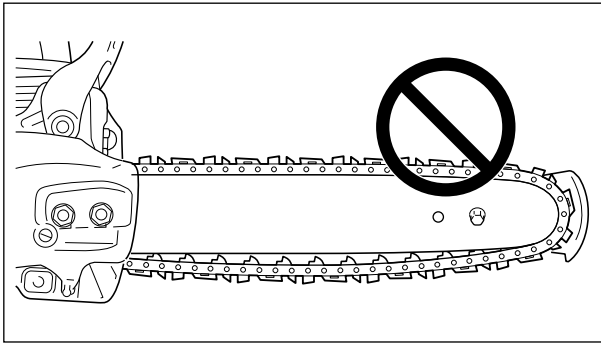

CHECKING CHAIN TENSION

- Chain tension should be checked frequently during work and corrected as necessary.



CAUTION

Do not operate with a loose chain.

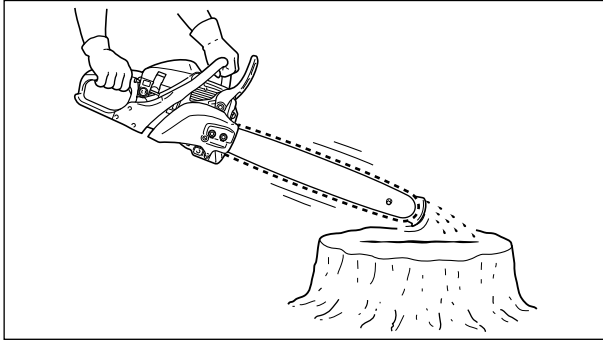

CHAIN LUBRICATION TEST

Hold the chain just above a dry surface and open the throttle to half speed for 30 seconds.

A thin line of “thrown” oil should be seen on the dry surface.

CUTTING INSTRUCTION

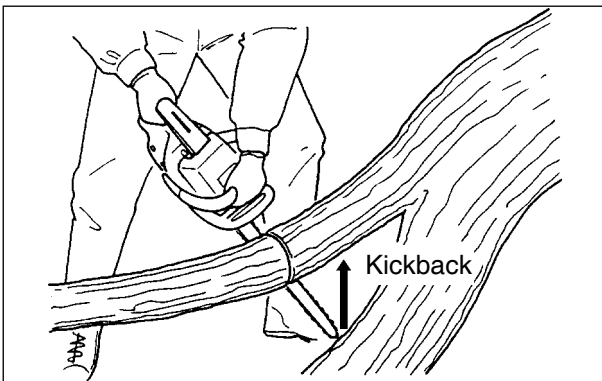
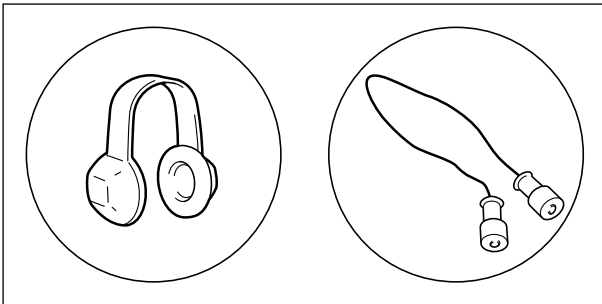

GENERAL



CAUTION

- Read the ECHO “CHAIN SAW SAFETY MANUAL” included with your chain saw for additional cutting and safety instructions.
- Wear suitable hearing protection such as earmuffs or earplugs to protect against objectionable or uncomfortable loud noises.
- Do not let the tip of the bar touch anything while the engine is running.
At cutting speed the chain is moving at a high rate of speed.
Should the tip contact a limb or log while the chain is moving, the tip will be pushed upward with considerable force.
This is known as kickback. Avoid it!

In all circumstances the operation of the chain saw is a one-man job.

It is difficult at times to take care for your own safety, so don't assume the responsibility for a helper as well.

After you have learned the basic techniques of using the saw, your best aid will be your own good common sense.



The accepted way to hold the saw is to stand to the left of the saw with your left hand on the front handlebar and your right hand on the rear handle so you can operate the throttle trigger with your right index finger. Before attempting to fell a tree, cut some small logs or limbs. Become thoroughly familiar with the controls and the responses of the saw.

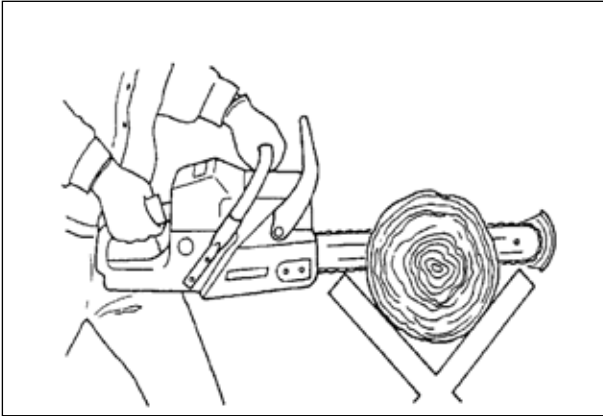

Start the engine, see that it is running properly. Squeeze the trigger to open the throttle wide open and start the cut. If the chain is properly sharpened, the cutting should be relatively effortless. It is not necessary to press down hard to make the saw cut. Pushing the saw too hard will slow the engine and cutting will actually be more difficult.

Some material may adversely affect the housings of your chain saw. (Example palm Tree Acid, fertilizer etc.) To avoid housing deterioration, carefully remove all packed sawdust around clutch and guide bar area and wash with water. Coat metal parts with light oil.

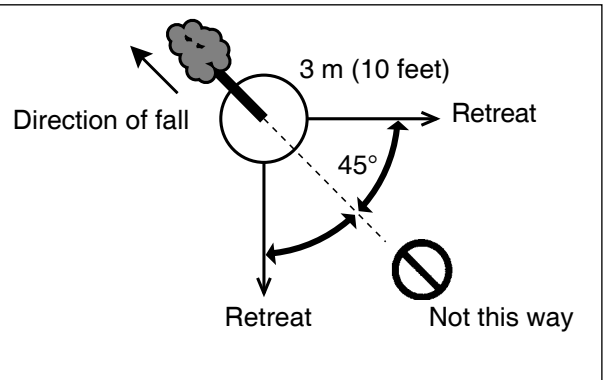

FELLING THE TREE

A falling tree can seriously damage anything it may hit - a car, a house, a fence, a power-line, or another tree. There are ways to make a tree fall where you want it, so first decide where that is! Before cutting, clear the area around the tree. You will need good footing while working and you should be able to work the saw without hitting any obstacles. Next, select a path of retreat. When the tree begins to fall you should retreat away from the direction of fall at a 45-degree angle and at least 3 m (10 feet) from the trunk to avoid the trunk kicking back over the stump.

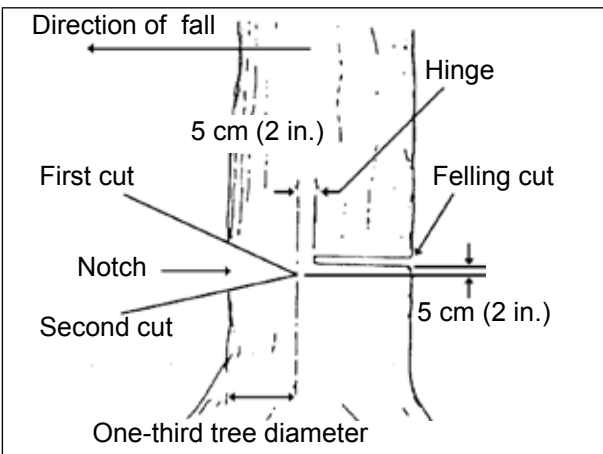

Begin the cut on the side to which the tree is to fall. Cut a notch about 1/3 of the way into the tree. The position of this notch is important since the tree will try to fall "into" the notch. The felling cut is made on the side opposite the notch and at a level about 5 cm (2 in.) above the bottom of the notch. Do not try to cut through to the notch with the felling cut. The remaining wood between the notch cut and felling cut about 5 cm (2 in.) will act as a hinge when the tree falls, guiding it in the desired direction. When the tree starts to fall, kill the engine, place the saw on the ground and make your retreat quickly.

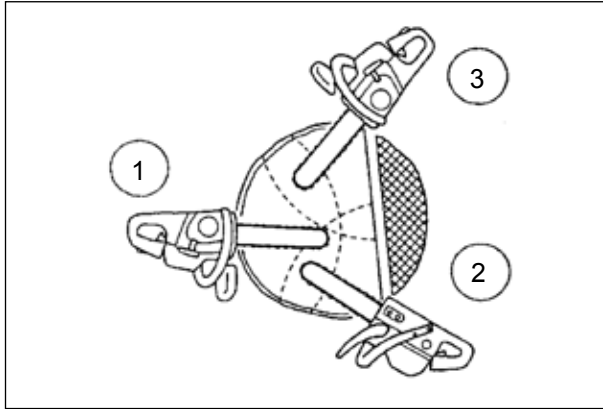

To fell big trees with a diameter exceeding twice the bar length, start the notching cuts from one side and draw the saw through to the other side of the notch. Start the back cut on one side of the tree, pivoting the saw through to form the desired hinge on that side. Then remove the saw for the second cut. Insert the saw in the first cut, very carefully so as not to cause kickback. The final cut is made by drawing the saw forward in the cut to reach the hinge.

LIMBING

Limbing a fallen tree is much the same as bucking.

Never stand on the tree that you are limbing.

When limbing, caution is the word.

Be careful of the tip touching other limbs.

Always use both hands.

Don't cut with the saw overhead or aligned vertically with your body. If the saw should kickback, you may not have enough control to prevent possible injury.



BUCKING

Bucking is the sawing of a log or fallen tree into smaller pieces.

There are a few basic rules which apply to all bucking operations.

Keep both hands on the handles at all times. Support logs if possible.

When cutting on a slope or hillside, always stand uphill.

Keep in mind that the wood is heavy and that it will bend and pinch the saw if improperly supported. The trunk will weaken at the point where you make the cut unless the tree is lying on perfectly flat ground or supported as shown. If you make the cut with the tree on the ground, don't let the saw's chain dig into the earth; it is harmful for the saw, and you stand a good chance of being struck by flying debris.

To cut the trunk, use the bucking and two-cut sequence shown. The first cut should be no deeper than one-third the trunk diameter.

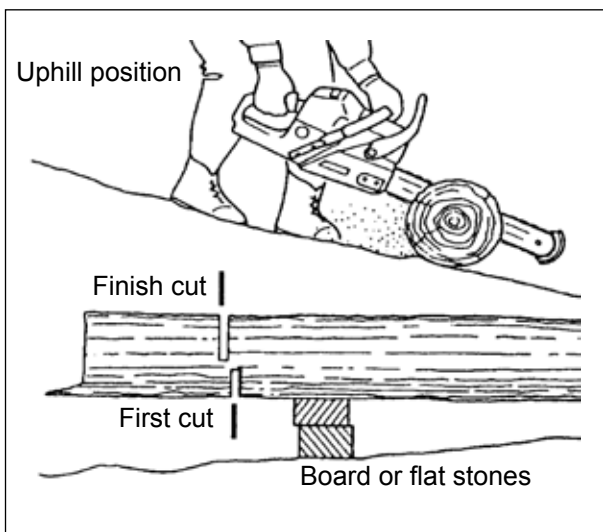

DANGER

- **Kickback is generated when the rotation of the chain is arrested for some reason. The most dangerous effect of this action occurs when the nose of the bar contacts another object, the chain is momentarily stopped and all the energy of the engine throws the bar upwards and backwards towards the operator.**
- **The chain saw industry and government agencies have attempted to prescribe various safety devices, but the best protection is to avoid kickback.**
- **Comply with the safety precautions as listed in this Manual and Safety Manual.**

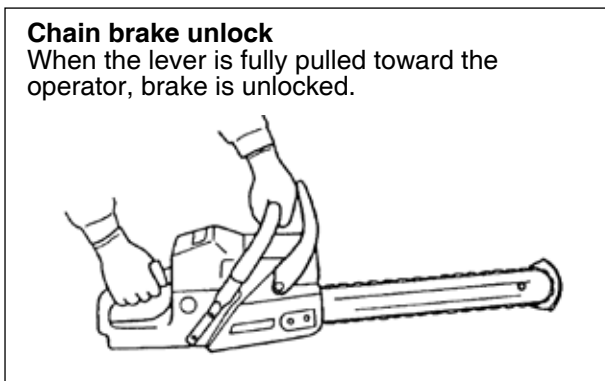
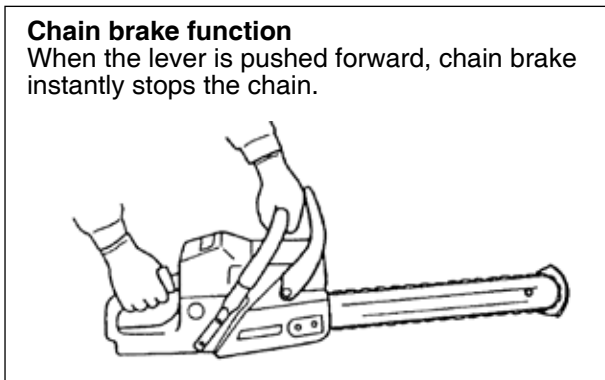
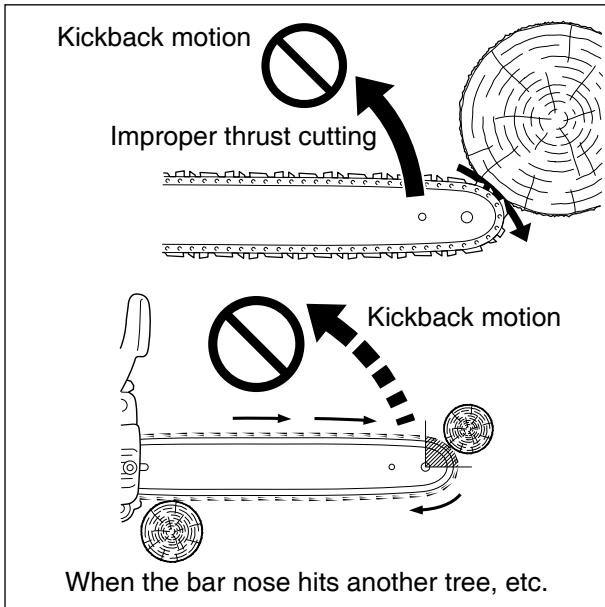

CHAIN BRAKE OPERATION

- Set the lever in the unlocked position before starting to cut.
- If the brake is tripped by kickback reaction, the chain will stop immediately. Release the throttle to avoid possible damage to the engine or clutch.
- Do not attempt to operate the engine with the brake locked.

TESTING THE BRAKE

- Start the engine on a solid level surface and run at a fast idle until warm.
- Hold the saw firmly by the handles and accelerate the engine to a fast idle.
- Slowly operate the chain brake lever while holding the saw firmly on the ground. When the brake lever trips, the chain should stop. Immediately release the throttle trigger.

WARNING

If the chain does not stop immediately, return the saw to your authorized ECHO dealer for repair.

NOTICE

- For practice, while cutting a small tree, push the lever forward to lock the brake.
- Confirm that the brake works properly before each use.
- If the chain brake is clogged with wood chips, function of the brake may deteriorate. Always keep the device clean.
- Do not increase engine revolution while the chain brake is locked.
- When using throttle latch at starting, keep the chain brake locked.

IMPORTANT

Do not allow the saw to tip forward in order to avoid damage to the chain.

End of the guide bar may be placed at the height of about 55 cm (22 in.).

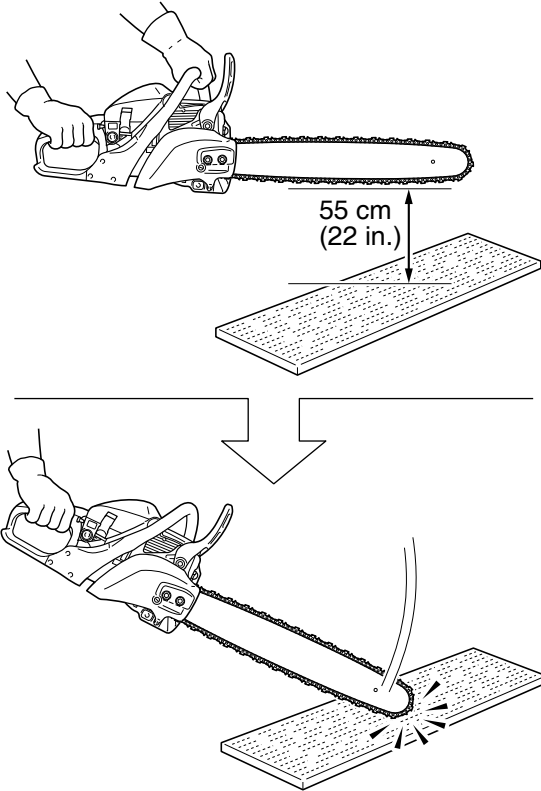

Rear handle should be gripped lightly with the right hand.

AUTOMATIC CHAIN BRAKE

Kickback produced from the tip of the guide bar will trip the automatic chain brake. To make sure that the automatic chain brake operates properly, follow these steps:

1. **Stop the engine.**
2. Hold the saw with the guide bar approximately 55 cm (22 in.) above a wooden surface. Right hand should hold the rear handle, and left hand should hold the front handle.
3. Release the front handle and drop the end of the guide bar against the wooden surface.
4. The impact should lock the chain brake.

IMPORTANT

When checking the operation of the automatic chain brake, use a soft surface substance like wood to provide the impact so the chain is not damaged.

Warm weather position

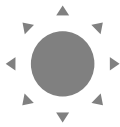

Cold weather "storage" position

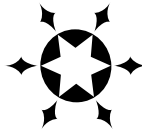

Warm weather position

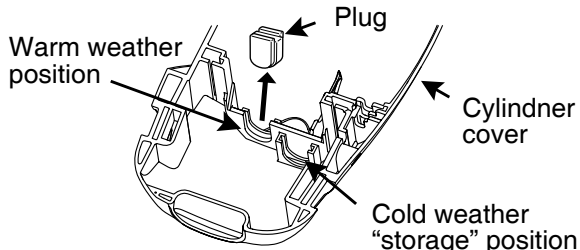

WINTER OPERATION

Use the winter plug to prevent carburetor trouble in winter.

- Release the cylinder cover latch and remove cylinder cover. Remove plug from warm weather position, and install into cold weather "storage" position.

NOTICE

For operation at normal temperature return the plug to its original place. (5°C, 41°F)
It causes over heating of the engine.

CHAIN AND GUIDE BAR COMBINATION

The following combinations are recommended for model CS-352.

Guide Bar		Saw chain		
Length mm (in)	Part No.	Pitch mm (in)	Part No.	Links
	Double Guard			
305 (12)	12A0CD3745	9.53 (3/8)	91VG45CQ, 91P45CQ	45
356 (14)	14A0CD3752	9.53 (3/8)	91VG52CQ, 91P52CQ	52
406 (16)	16A0CD3757	9.53 (3/8)	91VG57CQ, 91P57CQ	57



WARNING

Use of replacement saw chain and/or guide bar other than that specified, or operation without the “tip guard” in place, may cause severe kickback resulting in serious injury.

Only use saw chain designated as, “LOW-KICKBACK,” that meets the ANSI B175.1-2000 Standard when tested on the representative sample of chain saws below 3.8 C.I.D., and the Echo guide bar specified.

IMPORTANT

Chain and guide bar gauge size must be identical. Use Bar/Chain combinations shown in table above.

IMPORTANT

If your kick guard is damaged or lost, contact your Echo dealer for a replacement. For the name of the Echo dealer nearest you, Call: 1-800-432-ECHO (3246) or on the web at www.echo-usa.com.

Refer to your Chain Saw Safety Manual for kick guard application information.

GUIDE BAR

(Low-kickback)

Replacement guide bars.

The following guide bars may be considered to have equivalent kickback energy.

- Sprocket nose guide bars of the same length and nose radius, same pitch and having the same number of teeth.
- Hard nose guide bars of the same length and nose radius as a sprocket nose bar.

SAW CHAIN

(Low-kickback)



CAUTION

Do not use replacement saw chain unless it has been designated as meeting the ANSI B175.1 - 2000 kickback performance requirements, when tested on the representative sample of chain saws below 3.8 c.i.d. specified in ANSI B175.1 - 2000.

NOTE

LOW KICKBACK SAW CHAIN meets the kickback performance requirements of ANSI B175.1 - 2000 (safety requirements for gasoline-powered chain saws).

MAINTENANCE AND CARE



WARNING

Moving parts can amputate fingers or cause severe injuries. Keep hands, clothing and loose objects away from all openings. Always stop engine, disconnect spark plug, and make sure all moving parts have come to a complete stop before removing obstructions, clearing debris, or servicing unit. Allow unit to cool before performing service. Wear gloves to protect hands from sharp edges and hot surfaces.

Your ECHO unit is designed to provide many hours of trouble free service. Regular scheduled maintenance will help your unit achieve that goal. If you are unsure or are not equipped with the necessary tools, you may want to take your unit to an ECHO Service Dealer for maintenance. To help you decide whether you want to DO-IT-YOURSELF or have the ECHO Dealer do it, each maintenance task has been graded. If the task is not listed see your Echo dealer for repairs.

SKILL LEVELS

Level 1 = Easy to do. Common tools may be required.

Level 2 = Moderate difficulty. Some specialized tools may be required.

ECHO offers **REPOWER™** Maintenance Kits and Parts to make your maintenance job easier.

MAINTENANCE INTERVALS

COMPONENT/ SYSTEM	MAINTENANCE PROCEDURE	REQ'D SKILL LEVEL	DAILY OR BEFORE USE	EVERY REFUEL	3 MONTHS OR 90 HOURS	YEARLY 600 HOURS
Air Filter	Inspect/Clean	1	I / C *		R *	
Automatic Oiler	Inspect/Adjust	1	I			
Oil Filter	Inspect/Replace	1	I		I/C *	
Fuel System	Inspect/Replace	1	I (1) *	I (1) *		
Fuel Filter	Inspect/Replace	1			I *	I / R *
Fuel Cap Gasket	Replace	1			I *	R *
Guide Bar & Sprocket Nose	Inspect/Clean/Lubricate	1	I / C *	I		
Saw Chain	Inspect/Sharpen/Replace/ Tensioning	2	I *			
Sprocket	Inspect/Replace	2	I *			
Spark Plug	Inspect/Clean	1			I / C / R *	
Cooling System	Inspect/Clean	2	I / C			
Muffler Spark Arrestor	Inspect/Clean/Replace	2			I / C / R *	
Cylinder Exhaust Port	Inspect/Clean/Decarbon	2			I / C	
Recoil Starter Rope	Inspect/Clean	1	I / C *			
Screws/Nuts/Bolts	Inspect/Tighten/Replace	1	I *			

MAINTENANCE PROCEDURE LETTER CODES: I = INSPECT, R = REPLACE, C = CLEAN

IMPORTANT NOTE - Time intervals shown are maximum. Actual use and your experience will determine the frequency of required maintenance.

MAINTENANCE PROCEDURE NOTES:

(1) Low evaporative fuel tanks DO NOT require regular maintenance to maintain emission integrity.

* Replacement is recommended based on the finding of damage or wear during inspection.

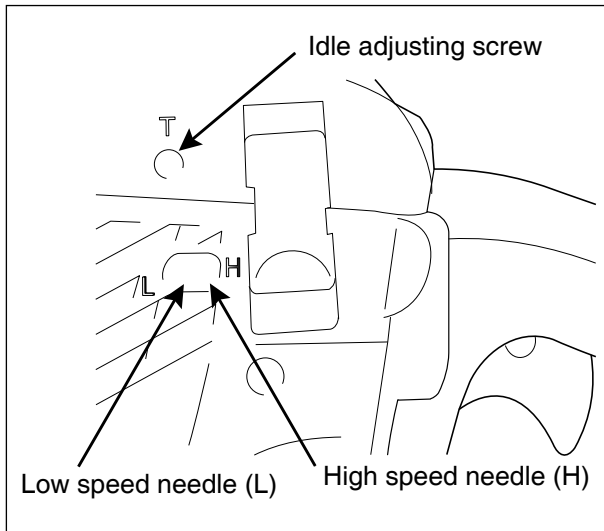

CARBURETOR ADJUSTMENT

Engine Break-In

New engines must be operated a minimum duration of two tanks of fuel break-in before carburetor adjustments can be made. During the break-in period your engine performance will increase and exhaust emissions will stabilize. Idle speed can be adjusted as required.

High Altitude Operation

This engine has been factory adjusted to maintain satisfactory starting, emission, and durability performance up to 1,100 feet above sea level (ASL) (96.0 kPa). To maintain proper engine operation and emission compliance above 1,100 feet ASL the carburetor may need to be adjusted by an authorized ECHO service dealer.

IMPORTANT

If the engine is adjusted for operation *above* 1,100 feet ASL, the carburetor must be re-adjusted when operating the engine *below* 1,100 feet ASL, otherwise severe engine damage may result.

Every unit is run at the factory and the carburetor is set in compliance with Emission Regulations. In addition, the carburetor is equipped with "H" (High Speed) and "L" (Low Speed) needle adjustment limiters that prevent settings outside acceptable limits.

1. Before adjusting carburetor clean or replace air filter and muffler "Spark Arrestor Screen".
2. Make sure the bar and chain are properly adjusted.
3. Start engine and run several minutes to bring to operating temperature. Flash choke twice during warm-up to clear any air from the fuel system.
4. Stop engine.
Turn "H" speed needle counterclockwise (CCW) to stop.
Turn "L" speed needle midway between full clockwise (CW) stop and CCW stop.
5. Idle Speed Adjustment:
 - Start engine, turn "Idle" speed adjustment screw CW until the saw chain begins to turn, then turn screw out CCW until the saw chain stops turning. Turn screw out, CCW, an additional 1/4 turn.



WARNING

Cutting attachment must not move when unit is idling.

6. Accelerate to full throttle for 2 - 3 seconds to clear any excess fuel in the engine, then return to idle. Accelerate engine to full throttle to check for smooth transition from idle to high speed. If engine hesitates turn "L" needle CCW 1/8 turn and repeat acceleration. Continue adjustment until smooth acceleration results.
7. Check idle speed and reset if necessary as described in item 5. If a tachometer is available idle speed should be set to 3000 r/min.



CAUTION

When starting, idling adjustment speed should be adjusted not to rotate the saw chain. Correct idle speed is adjusted 3000 r/min. Or 1/4 turn CCW from the point the chain stops moving. When you experience trouble with the carburetor, contact your dealer.

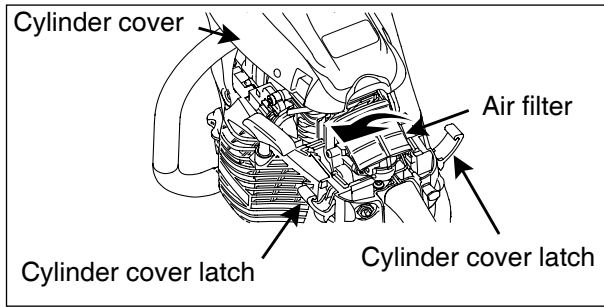

AIR FILTER

- Check before every use.
- Press hand guard forward and close choke.
- Release the cylinder cover latches, and remove the cylinder cover and air filter.
- Brush off dust lightly, or clean with compressed air, or replace the air filter.
- Reinstall air filter and the cylinder cover, engage latch.

CHECK FUEL SYSTEM

- Check before every use.
- After refueling, make sure fuel does not leak from around fuel pipe, fuel grommet or fuel tank cap.
- In case of fuel leakage there is a danger of fire. Stop using the machine immediately and request your dealer to inspect or replace.

SPARK PLUG

- Check periodically.
- The standard spark gap is 0.65 mm (0.026 in.).
- Correct the spark gap if it is wider or narrower than the standard gap.
- Fastening torque: 13 to 17 N·m (130 to 170 in. lb.).

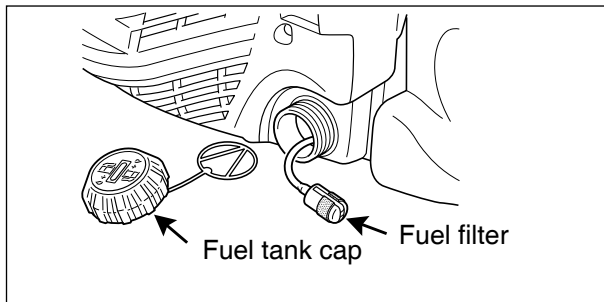
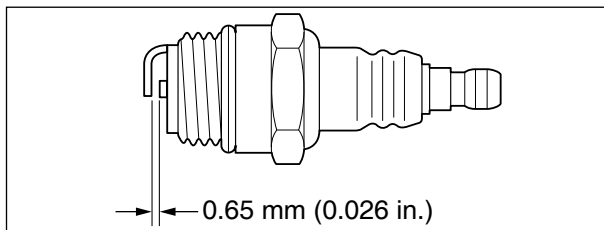

FUEL FILTER

- Check periodically.
- Do not allow dust to enter fuel tank.
- A clogged filter will cause difficulty in starting engine or abnormalities in engine performance.
- Pull the fuel filter out through fuel inlet port with a piece of steel wire or the like.
- When the filter is dirty, replace it.
- When the inside of the fuel tank is dirty, rinsing the tank out with gasoline can clean it.

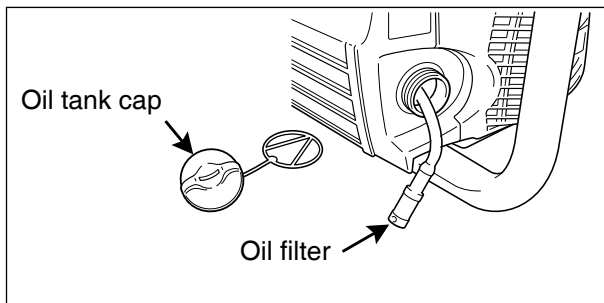

OIL FILTER

- Check periodically.
- Do not allow dust to enter into oil tank.
- A clogged oil filter will affect the normal lubricating system.
- Pull it out through oil filling hole with a piece of steel wire or the like.
- If the filter is dirty, wash it in gasoline or replace it.
- When the inside of the tank gets dirty, rinsing the tank out with gasoline can clean it.

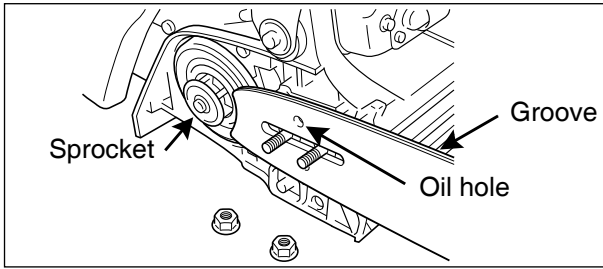

GUIDE BAR

- Clean before using.
 - Clean the groove of the guide bar with a small screwdriver.
 - Clean oil holes with a wire.
- Reverse guide bar periodically.
- Check sprocket and the clutch and clean the bar mount area before installation of the bar. Replace either or both if worn.

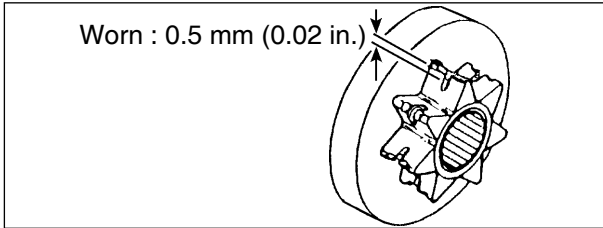

SPROCKET

- A damaged sprocket will cause premature damage or wear of saw chain.
 - When the sprocket has worn out 0.5 mm (0.02 in.) or more, replace it.
- Check sprocket when you install new chain. Replace it if worn.

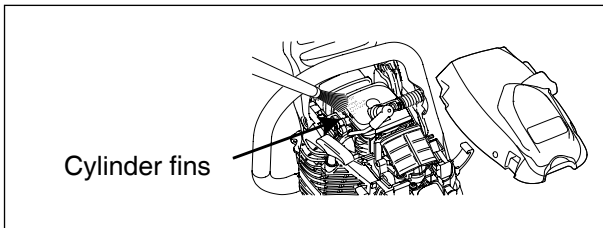

CYLINDER FINS

- Check periodically.
- Clogged fins will result in poor engine cooling.
- Remove dirt and dust from between fins to let cooling air pass easily.

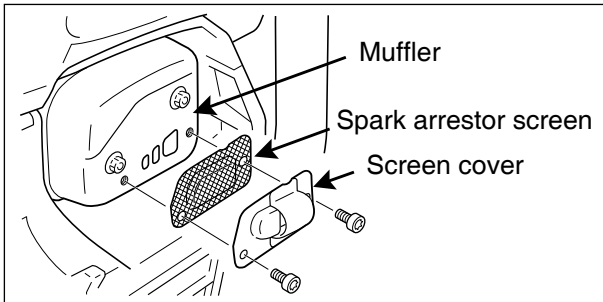

MUFFLER SPARK ARRESTOR

- Remove cylinder cover and remove spark plug lead.
- Remove spark arrestor screen cover and screen from muffler body.
- Clean carbon deposits from muffler components.
- Replace screen if it is cracked, or has holes burned through.
- Assemble components in reverse order.

NOTICE

Carbon deposits in muffler will cause drop in engine output. Spark arrestor screen must be checked periodically.

EXHAUST PORT CLEANING

Level 2

Parts Required: As needed: Muffler gasket

1. Remove cylinder cover and remove spark plug lead.
2. Place piston at top dead center. Remove muffler (A) and muffler gasket (B).
3. Use a wood or plastic scraping tool to clean deposits from cylinder exhaust port.

IMPORTANT

Never use a metal tool to scrape carbon from the exhaust port.

Do not scratch the cylinder or piston when cleaning the exhaust port. Do not allow carbon particles to enter the cylinder.

4. Inspect muffler gasket, and replace if damaged.
5. Install muffler gasket and muffler.
6. Tighten muffler mounting bolts (or nuts) to 60-80 in • lbf (70-90 kgf • cm).
7. Install cylinder cover and attach spark plug lead.
8. Start engine, and warm to operating temperature.
9. Stop engine, and re-tighten mounting bolts (or nuts) to specifications.

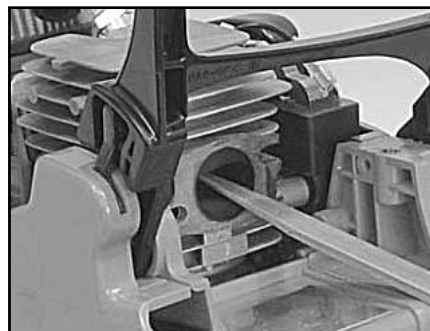
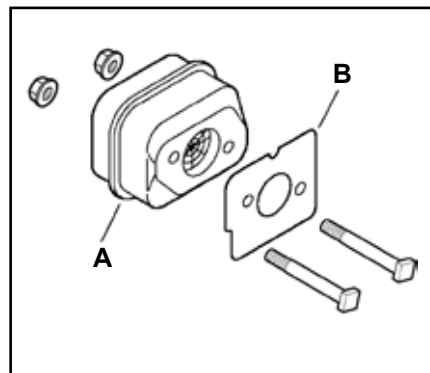

SETTING THE SAW CHAIN

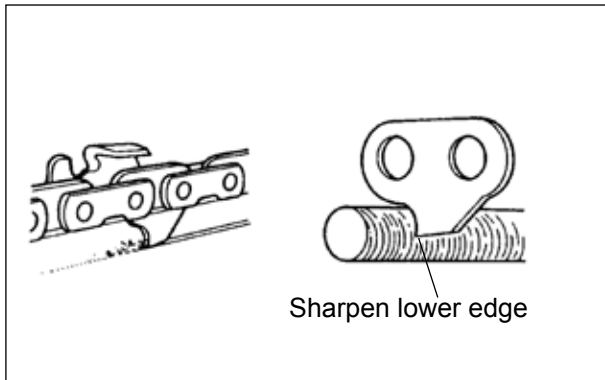
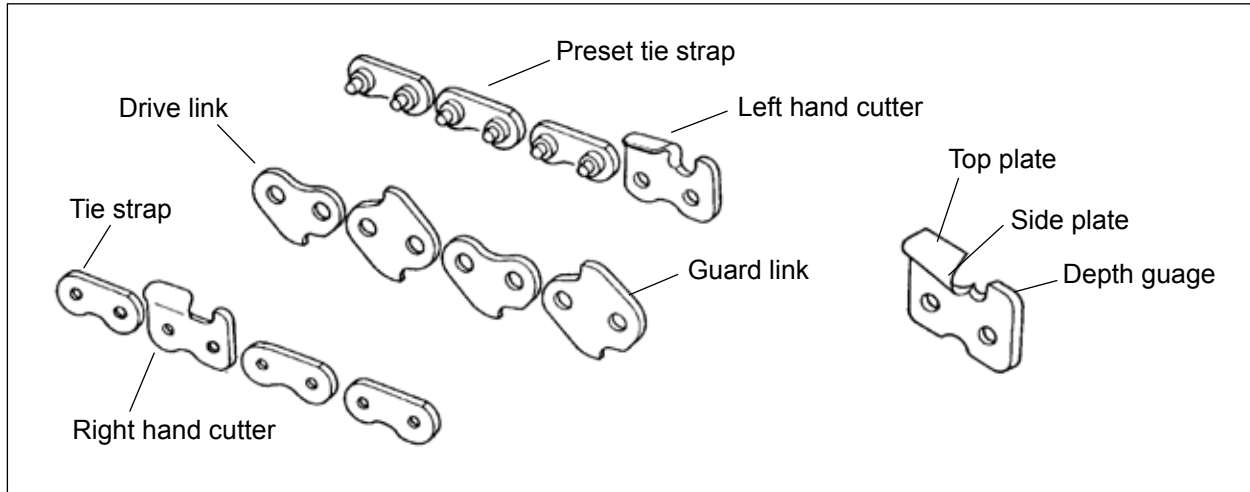

Important points for proper maintenance of saw chain:

- Keep the cutters sharp at all times.
- Keep the left and the right cutters properly aligned.
 - Note that blunt or irregular cutters will result in poor cutting performance, increased vibration of chains and premature breakage of the saw chain.
- Drive link serves to remove sawdust from the groove of the guide bar. Keep the lower edge of the drive link sharp where indicated.

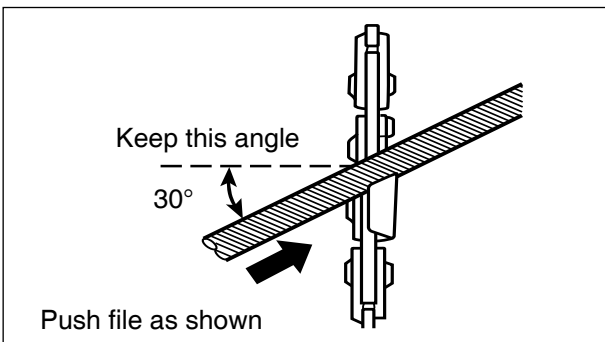

SETTING SAW CHAIN

- For setting saw chain, round file (4.0 mm dia. 5/32 in.) and flat file are used.
- To keep correct position and correct angle, use the file holder (Sure Sharp®).

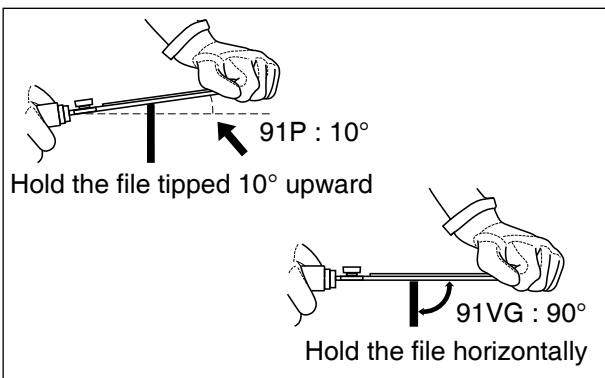

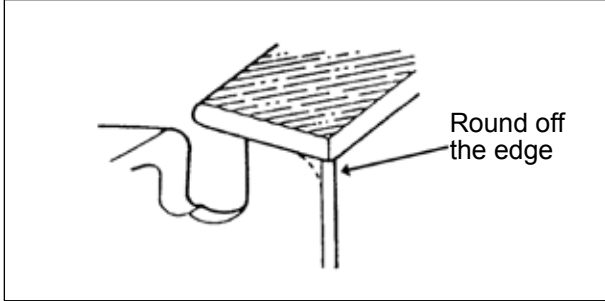
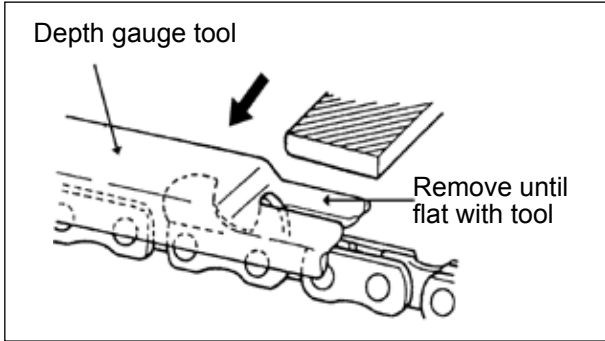
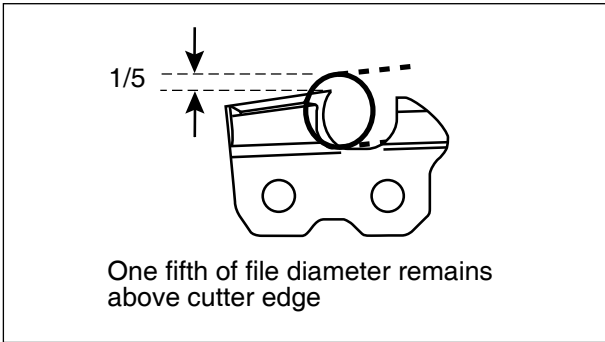

- Place the depth gauge tool firmly on guide bar so that depth gauge protrudes. Then file top of depth gauge with the flat file until flat with top of the depth gauge tool.

- Be sure to round off the front edge of the depth gauge.

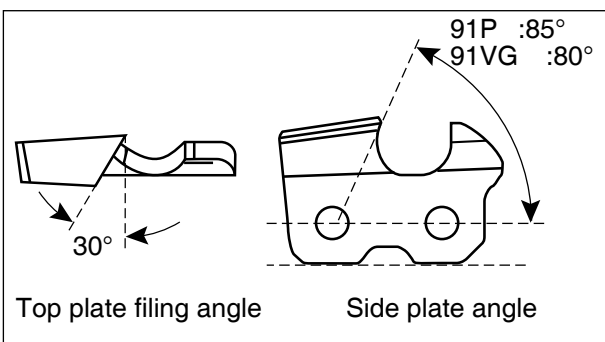

Properly filed cutters are shown in illustration.

When setting of the chain is finished, soak it in oil and wash away filings completely before using.

- When chain has been filed on the bar, supply sufficient oil to it, rotate the chain slowly to wash away the filings before using again.
- If the chain saw is operated with filings clogged in the groove, the saw chain and the guide bar will be damaged prematurely.
- If the saw chain becomes soiled with resin, for instance, clean it with kerosene and soak in it oil.

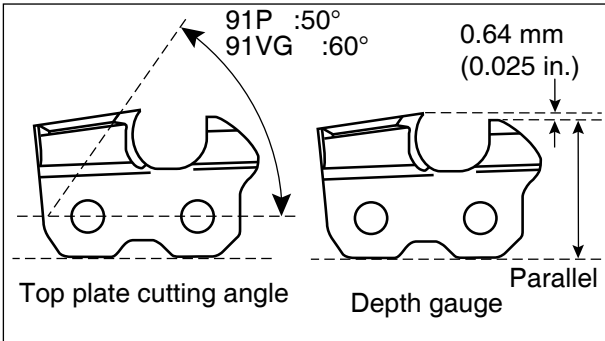

NOTICE
 These angles are referred to as Oregon 91P or 91VG.
 To sharpen other follow chain manufacturer's instruction.

TROUBLESHOOTING

ENGINE PROBLEM TROUBLESHOOTING CHART				
Problem	Check	Status	Cause	Remedy
Engine cranks - starts hard/ doesn't start	Fuel at carburetor	No fuel at carburetor	Fuel strainer clogged Fuel line clogged Carburetor	Clean or replace Clean or replace See your Echo dealer
	Fuel at cylinder	No fuel at cylinder	Carburetor	See your Echo dealer
		Muffler wet with fuel	Fuel Mixture too rich	Open choke Clean/replace air filter Adjust carburetor See your Echo dealer
	Spark at end of plug wire	No spark	Stop switch off Electrical problem Interlock switch	Turn switch to ON See your Echo dealer See your Echo dealer
	Spark at plug	No spark	Spark gap incorrect Covered with carbon Fouled with fuel Plug defective	Adjust to .65mm (0.026 in.) Clean or replace Clean or replace Replace plug
Engine runs, but dies or does not accelerate properly	Air filter	Air filter dirty	Normal wear	Clean or replace
	Fuel filter	Fuel filter dirty	Contaminants/residues in fuel	Replace
	Fuel vent	Fuel vent plugged	Contaminants/residues in fuel	Clean or replace
	Spark Plug	Plug dirty/worn	Normal wear	Clean and adjust or replace
	Carburetor	Improper adjustment	Vibration	Adjust
	Cooling System	Cooling system dirty/plugged	Extended operation in dirty/dusty locations	Clean
	Spark Arrestor Screen	Spark arrestor screen plugged	Normal wear	Replace
Engine does not crank	N/A	N/A	Internal engine problem	See your Echo dealer



WARNING

Fuel vapors are extremely flammable and may cause fire and/or explosion. Never test for ignition spark by grounding spark plug near cylinder plug hole, otherwise serious personal injury may result.

STORAGE AFTER USE

- Inspect and adjust every part of the chain saw.
 - Completely clean every part and repair if necessary.
 - Apply thin coating of oil on metal parts to prevent rust.
- Remove chain and guide bar.
- Drain fuel tank, pull starter slowly a few times to drain fuel from carburetor.
- Pour a small amount of clean motor oil into spark plug hole, pull starter and crank the engine until piston reaches: TOP DEAD CENTER.
- Store in a dry area, free from dust.

WARNING

Do not store in an enclosure where fuel fumes may accumulate or reach an open flame or spark.

CAUTION

Do not lend or rent your chain saw without the Instruction manual and Safety manual.

NOTICE

- For future reference, you should keep this Instruction manual and the Safety manual.
- If this Instruction manual or the Safety manual has become illegible or is lost, please purchase a new one from your ECHO dealer.

TECHNICAL DATA

MODEL			CS-352
Dimension	L x W x H	mm	396 x 232 x 268 (15.6 in. x 9.1 in. x 10.6 in.)
Mass	Power head, dry	kg	4.0 (8.8 lb.) Without chain and guide bar
Engine	Type		Air-cooled two-stroke single cylinder
	Displacement	mL (cm ³)	34.0 (2.075 cu. in.)
	Carburetor Magneto Spark plug Starter Power transmission		Diaphragm type Flywheel magneto: CDI system NGK BPM8Y Recoil starter Automatic centrifugal clutch
Fuel EGD	Mixture ratio		50 : 1 ratio with ECHO Power Blend X™, ISO-L- (ISO/CD 13738) and JASO M345-FD two-stroke, air-cooled engine oil.
	Gasoline		Use 89 octane unleaded. Do not use fuel containing methyl alcohol, more than 10 % ethyl alcohol or 15 % MTBE. Do not use alternative fuels such as E-15 or E-85.
	Tank capacity	L	0.25 (8.47 US. fl. oz.)
Oil	Bar and chain		ECHO bar and chain oil (or motor oil)
	Tank capacity	L	0.26 (8.81 US. fl. oz.)
Guide bar and saw chain			See page 22 for Chain and Guide Bar Combination
	Lubrication		Non-adjustable automatic oil pump
Engine speed	Idle	r/min	2500 - 3500
	Clutch engagement	r/min	3900 - 4500
	Wide open throttle	r/min	11500 - 13000
Standard features			Front hand guard, Rear hand guard, Anti-vibration device, Throttle control lockout, Chain brake, Chain catcher, Spark arrestor muffler, Kick guard, (Spiked bumper; Option)

* Technical data subject to change without notice.

WARRANTY STATEMENTS

ECHO LIMITED WARRANTY STATEMENT FOR PRODUCT SOLD IN USA AND CANADA BEGINNING 01/01/2010

ECHO'S RESPONSIBILITY

ECHO Incorporated's Limited Warranty, provides to the original purchaser that this ECHO product is free from defects in material and workmanship. Under normal use and maintenance from date of purchase, ECHO agrees to repair or replace at ECHO's discretion, any defective product free of charge at any authorized ECHO servicing dealer within listed below application time periods, limitations and exclusions. **THIS LIMITED WARRANTY IS ONLY APPLICABLE TO ECHO PRODUCTS SOLD BY AUTHORIZED ECHO DEALERS. IT IS EXTENDED TO THE ORIGINAL PURCHASER ONLY, AND IS NOT TRANSFERABLE TO SUBSEQUENT OWNERS EXCEPT FOR EMISSION RELATED PARTS.** Repair parts and accessories replaced under this warranty are warranted only for the balance of the original unit or accessory warranty period. Any damage caused by improper installation or improper maintenance is not covered by this warranty. All parts or products replaced under warranty become the property of ECHO, Inc. This warranty is separate from the Emission control warranty statement supplied with your new product. Please consult the Emission Control Warranty Statement for details regarding emission related parts. For a list of Authorized ECHO Dealers refer to WWW.ECHO-USA.COM or call **1-800-432-ECHO**.

OWNER'S RESPONSIBILITY

To ensure trouble free warranty coverage it is important that you register your ECHO equipment on-line at WWW.ECHO-USA.COM or by filling out the warranty registration card supplied with your unit. Registering your product confirms your warranty coverage and provides a direct link if we find it necessary to contact you.

The owner shall demonstrate reasonable care and use, and follow preventative maintenance, storage, fuel and oil usage as prescribed in the operator's manual. Should a product difficulty occur, you must, at your expense, deliver or ship your ECHO unit to an authorized ECHO servicing dealer for warranty repairs (within the applicable warranty period), and arrange for pick-up or return of your unit after the repairs have been made. For your nearest authorized ECHO servicing dealer, call ECHO's Dealer Referral Center, at 1-800-432-ECHO or you can locate an ECHO servicing dealer at WWW.ECHO-USA.COM. Should you require assistance or have questions concerning ECHO's Warranty Statement, you can contact our Consumer Product Support Department at 1-800-673-1558 or contact us through the web at WWW.ECHO-USA.COM.

PRODUCT WARRANTY PERIOD

RESIDENTIAL APPLICATION

- **5 YEAR WARRANTY** - All units for residential, or non-income producing use will be covered by this limited warranty for **five (5) years** from date of purchase.

EXCEPTIONS:

- For two-stroke engine powered products, the electronic ignition module, flexible drive cables, SRM solid drive shafts, and TC tines are warranted for the **life*** of the product on parts only.
- Cutting attachments such as, but not limited to, bars, chains, sprockets, blades, and nylon trimmer heads for residential or non-income producing use will be covered for failures due to defects in material or workmanship for a period of **60 days** from original product purchase date. Any misuse from contact with concrete, rocks, or other structures is not covered by this warranty.
- ECHO's Rapid Loader String Head carries a lifetime warranty on the line locking system, parts only; no labor. Refer to your operator's manual for string head installation and maintenance instructions.
- All SB-Series and PRO ATTACHMENT SERIES Split Shaft attachments carry the same warranty duration as the units they are designed to fit.

COMMERCIAL APPLICATION

- **1 YEAR WARRANTY** - All Chain Saws, QuikVent Saws, and Cut-Off Saws for commercial, institutional, agricultural, industrial, or income producing use will be covered by this limited warranty for one **(1) year** from the date of purchase.
- **2 YEAR WARRANTY** - All other units for commercial, institutional, agricultural, industrial, or income producing use will be covered by this limited warranty for two **(2) years** from the date of purchase.

EXCEPTIONS:

- For two-stroke engine powered products, the electronic ignition module, flexible drive cables, SRM solid drive shafts and TC tines, are warranted for the **life*** of the product on parts only.
- Cutting attachments such as, but not limited to, bars, chains, sprockets, blades, and nylon trimmer heads for commercial, institutional, agricultural, industrial, rental, or income producing will be covered for failures due to defects in material or workmanship for a period of **30 days** from original product purchase date. Any misuse from contact with concrete, rocks, or other structures is not covered by this warranty.
- ECHO's Rapid Loader String Head carries a lifetime warranty on the line locking system, parts only; no labor. Refer to your operator's manual for string head installation and maintenance instructions.
- All SB-Series and PRO ATTACHMENT SERIES Split Shaft attachments carry the same warranty duration as the units they are designed to fit.

RENTAL APPLICATION - 90 DAYS WARRANTY

- Units for rental use will be covered against defects in material and workmanship for a period of 90 days from the date of purchase.

* ECHO's liability under the "Lifetime" coverage is limited to furnishing parts specified under the PRODUCT WARRANTY PERIOD section of this warranty statement for "**Life**" free of charge for a period of ten (10) years after the date of the complete unit's final production.

PURCHASED REPAIR PARTS, SHORT BLOCKS AND ACCESSORIES

- 90-day residential, or non-income producing warranty
- 30-day commercial, institutional, agricultural, industrial, income producing, or rental application warranty

ATTENTION TWO-STROKE ENGINE POWER PRODUCT OWNERS

This ECHO two-stroke engine power product is a quality-engineered unit which has been manufactured to exact tolerances to provide superior performance. To help ensure the performance of the unit, it is required to use two-stroke oil which meets the ISO-L-EGD Standard per ISO/CD 13738 and JASO M345/FC/FD Standards. **ECHO Power Blend™ Two-Stroke Oil** is a premium two-stroke oil specifically formulated to meet ISO-L-EGD (ISO/CD 13738) and JASO M345/FC/FD Standards. The use of two-stroke oils designed for other applications, such as for outboard motors or lawnmowers can result in severe engine damage, and will void your two-stroke engine limited warranty.

THIS WARRANTY DOES NOT COVER DAMAGE CAUSED BY:

- Lack of lubrication or engine failure, due to the use of two-stroke oils that do not meet the ISO-L-EGD (ISO/CD 13738) and JASO M345/FC/FD Standards. Engine problems due to inadequate lubrication caused by failure to use an ISO-L-EGD compliant and JASO M345/FC/FD registered oil, will void the two-stroke engine limited warranty. ECHO Power Blend™ Two-Stroke Oil meets the ISO-L-EGD and JASO M345/FC/FD Standard. Emission related parts are covered for 5 years residential use or 2 years commercial use regardless of two-stroke oil used, per the statement listed in the EPA or California Emission Defect Warranty Explanation.
- Damage caused by use of gasohol, containing methanol (wood alcohol), or gasoline containing less than 89 octane. Only use gasoline which contains 89 octane or higher. Gasohol which contains a **maximum** 10% ethanol (grain alcohol) or 15% MTBE (methyl/tertiary/butyl/ether) is also approved. The prescribed mixing ratio of gasoline to oil is listed on the ECHO oil label and covered in your operator's manual.
- Engine damage caused by use of ether or any starting fluids.
- Damage caused by tampering with engine speed governor or emission components, or running engines above specified and recommended engine speeds as listed in your operator's manual.
- Operation of the unit with improperly maintained/removed cutting shield or removed/damaged air filter.
- Damage caused by dirt, pressure or steam cleaning the unit, salt water, corrosion, rust, varnish, abrasives, and moisture.
- Defects, malfunctions or failures resulting from abuse, misuse, neglect, modifications, alterations, normal wear, improper servicing, or use of unauthorized attachments.
- Incorrect storage procedures, stale fuel, including failure to provide or perform required maintenance services as prescribed in the operator's manual. Preventative maintenance as outlined in the operators manual is the customer's responsibility.
- Failures due to improper set-up, pre-delivery service or repair service by anyone other than authorized ECHO servicing dealer during the warranty period.
- Certain parts and other items are not warranted, including but not limited to: lubricants, starter cords, and engine tune-ups.
- Use of spark plugs other than those meeting performance and durability requirements of the OEM spark plug listed in the Operator's Manuals.
- Overheating or carbon scoring failures due to restricted, clogged exhaust port or combustion chamber, including damage to spark arrester screen.
- Adjustments after the first (30) thirty days and beyond, such as carburetor adjustment and throttle cable adjustment.
- Damage to gears or gear cases caused by contaminated grease or oil, use of incorrect type or viscosity of lubricants, and/or failure to comply with recommended grease or oil change intervals.
- Damage caused by loading SHRED 'N' VAC® beyond recommended capacity.
- Damage caused by pump or sprayer running dry, pumping or spraying caustic or flammable materials, or lack of or broken strainers.
- Additional damage to parts or components due to continued use after operational problem or failure occurs. Should operational problem or failure occur, the product should not be used, but delivered as is to an authorized ECHO servicing dealer.

It is a dealer's and/or customer's responsibility to complete and return the warranty registration card supplied with your ECHO product or by visiting WWW.ECHO-USA.COM. Your receipt of purchase including date, model and serial number must be maintained and presented to an authorized ECHO servicing dealer for warranty service. Proof of purchase rests solely with the customer. Some states do not allow limitations on how long an implied warranty lasts, so the above limitations may not apply to you. Some states do not allow the exclusion or limitation of incidental or consequential damages, so you may also have other specific legal rights which vary from state to state. This limited warranty is given by ECHO Incorporated, 400 Oakwood Rd., Lake Zurich, IL 60047.

DISCLAIMER OF IMPLIED WARRANTIES

This limited warranty is in lieu of all other expressed or implied warranties, including any warranty of FITNESS FOR A PARTICULAR PURPOSE OR USE and any implied warranty of **MERCHANTABILITY** otherwise applicable to this product. ECHO and its affiliated companies shall not be liable for any special incidental or consequential damage, including lost profits. There are no warranties extended other than as provided herein. This limited warranty may be modified only by ECHO.

99922201032
12/03/09

**ECHO INCORPORATED EMISSION CONTROL WARRANTY STATEMENT
FOR ECHO AND SHINDAIWA BRANDS**

The Environmental Protection Agency (EPA) and the California Air Resources Board (C.A.R.B.) and ECHO Incorporated (ECHO Inc.) are pleased to explain the emission control system warranty on your 2010 and later equipment/small off-road engine (SORE). New equipment/SORE must be designed, built and equipped to meet stringent EPA and C.A.R.B. anti-smog standards. ECHO Inc. must warrant the emission control system on your equipment/SORE for the periods of time listed below, provided there has been no abuse, neglect or improper maintenance of your equipment/SORE. Your emission control system may include parts such as: carburetor, fuel-injection system, ignition system, catalytic converter/muffler, fuel tank, fuel feed lines, fuel cap assembly, spark plug, air filters, and other associated components. Where a warrantable condition exists, ECHO Inc will repair your equipment/SORE at no cost to you including diagnosis, parts and labor. The Emission Control System warranty is extended to the original owner including all subsequent owners.

MANUFACTURER'S WARRANTY COVERAGE:

The emission control system is warranted for 2 years or the length of the ECHO Inc. warranty, whichever is longer. If any emission-related part on your equipment is defective, the part will be repaired or replaced by ECHO Inc. or its Authorized Service Representative.

OWNER'S WARRANTY RESPONSIBILITIES:

As the equipment/SORE owner, you are responsible for the performance of the required maintenance listed in your Operator's Manual. ECHO Inc. recommends that you retain all receipts covering maintenance on your equipment/SORE however, ECHO Inc. cannot deny warranty solely for the lack of receipts or for your failure to ensure the performance of all scheduled maintenance. As the equipment/SORE owner, you should be aware that ECHO Inc. may deny you warranty coverage if your equipment/SORE or a part has failed due to abuse, neglect, improper maintenance or unapproved modifications.

You are responsible for presenting your equipment/SORE to an ECHO Inc. authorized service representative as soon as a problem exists. The warranty repairs should be completed in a reasonable amount of time, not to exceed 30 days. If a warrantable condition exists and there is no Authorized Dealer within 100 miles, ECHO Inc. will pay to ship the unit to the nearest authorized dealer. If you have questions regarding your warranty coverage, you should contact ECHO Inc. at 1-800-673-1558, web site WWW.ECHO-USA.COM or contact Shindaiwa at 1-877-986-7783, web site WWW.SHINDAIWA.COM.

WHAT DOES THIS WARRANTY COVER?

ECHO Inc. warrants that your equipment/SORE was designed, built and equipped to conform with applicable EPA and C.A.R.B. emissions standards and that your equipment/SORE is free from defects in material and workmanship that would cause it to fail to conform with applicable requirements for 2 years or the length of the ECHO Inc. warranty, whichever is longer. The warranty period begins on the date the product is purchased by an end user.

HOW WILL A COVERED PART BE CORRECTED?

If there is a defect in a part covered by this warranty, any ECHO Inc. Authorized Service Dealer will correct the defect. You will not have to pay anything to have the part adjusted, repaired or replaced. This includes any labor and diagnosis for warranted repairs performed by the dealer. In addition, engine parts not expressly covered under this warranty but whose failure is a result of a failure of a covered part will be warranted.

WHAT PARTS ARE COVERED?

Any applicable emission related part not scheduled for "required maintenance" will be repaired or replaced within the warranty period. The repaired or replaced part will be warranted for the remaining ECHO Inc. warranty period.

Any warranted part that is scheduled only for regular inspection in the written instructions supplied is warranted for the warranty period stated above. Any such part repaired or replaced under warranty will be warranted for the remaining ECHO Inc. warranty period.

Any emission related part scheduled for replacement during "required maintenance" is warranted for the period of time prior to the first scheduled replacement point for that part. Any such part repaired or replaced under warranty shall be warranted for the remainder of the period prior to the first scheduled replacement point for that part.

Any manufacturer-approved replacement part may be used in the performance of any warranty maintenance or repairs on emission related parts, and must be provided without charge if the part is still under warranty.

Any replacement part that is equivalent in performance and durability may be used in non-warranty maintenance or repairs, and shall not reduce the warranty obligations of the manufacturer.

Throughout the equipment/SORE warranty period, ECHO Inc. will maintain a supply of warranted parts sufficient to meet the expected demand for such parts.

SPECIFIC EMISSION RELATED WARRANTED PARTS:

- Electronic Ignition System
- Catalytic Converter / Muffler Assembly
- Choke
- Fuel Tank
- Air Filter
- Spark Plug
- Carburetor (complete assembly or replaceable components)
- Fuel-Injection Assembly (or replaceable components)
- Fuel Cap Assembly
- Fuel Feed Line (and associated clamps/connectors as applicable)

WHAT IS NOT COVERED?

Any failure caused by abuse, neglect, improper maintenance, unapproved modifications, use of unapproved add-on parts/modified parts or unapproved accessories.

This Emission Control Warranty is valid only for the U.S.A., its Territories, and Canada.

**99922201033
01/2010**

NOTES

NOTES

NOTES

SERVICING INFORMATION

PARTS/SERIAL NUMBER

Genuine ECHO Parts and ECHO REPOWER™ Parts and Assemblies for your ECHO products are available only from an Authorized ECHO Dealer. When you do need to buy parts **always** have the Model Number, Type and Serial Number of the unit with you. You can find these numbers on the engine housing. For future reference, write them in the space provided below.

Model No. _____ Type _____ SN. _____

SERVICE

Service of this product during the warranty period must be performed by an Authorized ECHO Service Dealer. For the name and address of the Authorized ECHO Service Dealer nearest you, ask your retailer or call: 1-800-432-ECHO (3246). Dealer information is also available on our Web Site. When presenting your unit for Warranty service/repairs, proof of purchase is required.

ECHO CONSUMER PRODUCT SUPPORT

If you require assistance or have questions concerning the application, operation or maintenance of this product you may call the ECHO Consumer Product Support Department at 1-800-673-1558 from 8:30 am to 4:30 pm (Central Standard Time) Monday through Friday. Before calling, please know the model and serial number of your unit.

WARRANTY REGISTRATION

To ensure trouble free warranty coverage it is important that you register your ECHO equipment on-line at www.echo-usa.com or filling out the warranty registration card supplied with your unit. Registering your product confirms your warranty coverage and provides a direct link between you and ECHO if we find it necessary to contact you.

ADDITIONAL OR REPLACEMENT MANUALS

Replacement Operator, Safety Manuals, and Parts Catalogs are available from your ECHO dealer or at www.echo-usa.com or by contacting ECHO Inc., 400 Oakwood Road, Lake Zurich, IL 60047 (800-673-1558). Always check the ECHO Web Site for updated information.

Safety Videos are available from your Echo dealer. A \$5.00 shipping charge will be required for each video.

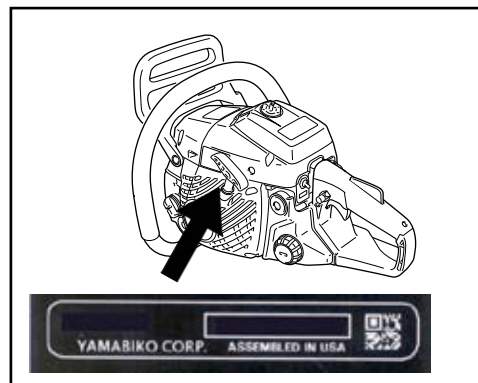

DEALER? Call
1-800-432-ECHO
1-800-432-3246
or
www.echo-usa.com

CONSUMER PRODUCT
SUPPORT
1-800-673-1558
8:30 - 4:30 Mon - Fri C.S.T.

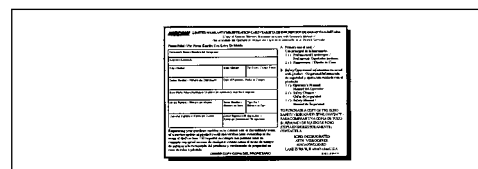

ECHO

ECHO, INCORPORATED

400 OAKWOOD ROAD
LAKE ZURICH, IL 60047-1564

www.echo-usa.com

C19711005001-C19711999999
C19612020001/C19612999999