



# THE BASEMENT WATCHDOG™

## Big Combo CONNECT

# Combination Primary and Backup Sump Pump System

## Instruction Manual & Safety Warnings

### Table of Contents

<b>Important Safety Warnings and Instructions</b>			
Electrical precautions	1	Cleaning the battery terminals	7
Battery preparation	1	Replacing the battery	8
Battery precautions	1	Fuse alarm	9
		Water alarm	9
		Pump alarm	10
<b>Introduction</b>		Replacing the backup pump	10
Items included in system	2	Replacing the primary pump	10
Additional items needed	2	Power alarm	11
System specifications	2	Charging	12
		System operating	12
		<b>Testing the System</b>	
<b>Installing the Pipe and Pump</b>	3	Test-Reset-Silence button	12
		Testing the float switches	12
<b>Preparing the Battery</b>	4,5		
		<b>Using the Remote Notification</b>	
<b>Battery Maintenance</b>	5	Remote Terminal	12
		Remote Alarm	12
<b>System Connections</b>		<b>USB Data Port</b>	12
Mounting the backup control unit	5		
Connecting the backup pump	5	<b>Connect Modules</b>	12,13
Installing the battery fluid sensor	5		
Connecting the battery	6	<b>Maintenance Check List</b>	13
Connecting the charger	6		
Connecting the primary pump	6	<b>Parts &amp; Service Information</b>	
		Technical support	13
<b>Product Operation</b>	6	<b>Replacement Parts Diagram &amp; List</b>	13
		<b>Troubleshooting Guide</b>	14
<b>Understanding the Warning Lights and Alarms</b>		<b>Warranty</b>	15
Silencing the alarm during an emergency	7		
Battery alarm	7		



This manual is for the systems that have the BWSP-A backup controller, which can accommodate maintenance or maintenance free batteries. See pages 2-6 for additional information.

**IMPORTANT:** Even if you have the Basement Watchdog sump pump system installed by someone else, you must read and follow the safety information contained in this manual. Failure to do so could result in property damage, serious injury, or death.

## Important Safety Warnings & Instructions

**SAVE THESE INSTRUCTIONS.** This manual contains important SAFETY WARNINGS and OPERATING INSTRUCTIONS for the Basement Watchdog combination sump pump system. You will need to refer to it before attempting any installation or maintenance. **ALWAYS** keep these instructions with the unit so that they will be easily accessible.

Failure to read and follow these warnings and instructions could result in property damage, serious injury, or death. It is important to read this manual, even if you did not install the Basement Watchdog combination sump pump, since this manual contains safety information regarding the use and maintenance of this product. **DO NOT DISCARD THIS MANUAL.**

### ELECTRICAL PRECAUTIONS

#### **⚠ WARNING**

This installation must be in accordance with the National Electric Code and all applicable local codes and ordinances.

#### **⚠ DANGER**

Risk of electrical shock and fire hazard. May result in death serious injury, shock or burns. To help reduce these risks, observe the following precautions:

- **DO NOT** walk on wet areas of the basement until all power has been turned off. If the main power supply is in a wet basement, call an electrician.
- **ALWAYS** disconnect the pumps from the power source before servicing or making adjustments.
- **ALWAYS** unplug the control units and disconnect the cables from the battery before attempting any maintenance or cleaning.
- **NEVER** handle the pump or motor with wet hands or when standing on a wet or damp surface while the pump is plugged into the power source.
- **MAKE SURE THERE IS A PROPERLY GROUNDED RECEPTACLE AVAILABLE.** This pump is wired with a 3-prong grounded plug. To reduce the risk of electric shock, be certain that it is only connected to a properly grounded 3-prong receptacle. If you have a 2-prong receptacle, have a licensed electrician replace it with a 3-prong receptacle according to local codes and ordinances.

- **NEVER** bypass grounding wires or remove the ground prong from the plug.
- **DO NOT** use an extension cord. The electrical outlet should be within the length of the pump's power cord, and at least 4 feet above the floor level to minimize potential hazards from flood conditions.
- **DO NOT** use an attachment not recommended or sold by the manufacturer. It may result in a risk of fire or injury from an electrical shock.
- **DO** protect the electrical cord from sharp objects, hot surfaces, oil and chemicals. Avoid kinking the cord.
- **MAKE SURE** the supply circuit has a dedicated fuse or circuit breaker rated to handle the power requirements noted on the nameplate of the pump.

#### **CAUTION**

To reduce the risk of hazards that can cause injury or property damage, observe the following precautions:

- **DO NOT** use the power cord or strain relief to carry the pumps. Use the handle.
- **DO NOT** pull on the float switch cords
- **DO NOT** pull on the cord to disconnect the system or the pump. Pull the plug.
- **DO NOT** expose the control units to water, rain or snow.
- **DO NOT** place the controllers on the floor. The electrical outlet should be within the length of the pump's power cord and at least 4 ft above the floor.
- **DO NOT** operate the pumps or control units if they have been damaged in any way.
- **DO NOT** use pumps in pits handling raw sewage, salt water, or hazardous liquids. This product is for ground water use only.
- **DO NOT** disassemble the pumps or control units. When service is required, contact Glentronics' technical support at 800-991-0466, option 3. Return the product to the manufacturer for any repairs at the following address:  
Glentronics, Inc.  
645 Heathrow Drive, Lincolnshire, IL 60069

### BATTERY PREPARATION

#### **⚠ WARNING / POISON**

Sulfuric acid can cause blindness or severe burns. Avoid contact with skin, eyes or clothing. In the event of accident, flush with water and call a physician immediately. **KEEP OUT OF REACH OF CHILDREN.**

To help reduce these risks, observe the following precautions:

- Someone should be within range of your voice or close enough to come to your aid when you work near a lead-acid battery.
- Have plenty of fresh water and soap nearby in case battery acid contacts skin, clothing or eyes.
- Wear eye and clothing protection and avoid touching your eyes while working with battery acid or working near the battery.
- If battery acid contacts skin or clothing, wash immediately with soap and water. If acid enters eye, immediately flood eye with running cold water for at least 15 minutes and get medical attention.

**⚠ WARNING:** Battery posts and terminals contain lead, lead compounds or other chemicals known to the State of California to cause cancer, birth defects or other reproductive harm. Wash hands after handling. See <https://www.p65warnings.ca.gov/> for more information.

**⚠ WARNING:** Battery fluid can expose you to chemicals including strong inorganic acid mists containing sulfuric acid, which is known to the State of California to cause cancer. For more information go to [www.P65warnings.ca.gov](http://www.P65warnings.ca.gov).

### BATTERY PRECAUTIONS

#### **⚠ DANGER**

Explosive gases could cause serious injury or death. Cigarettes, flames or sparks could cause battery to explode in enclosed spaces. Charge in well-ventilated area. Always shield eyes and face from battery. Keep vent caps tight and level.

To help reduce these risks, observe the following precautions:

- **NEVER** smoke or allow a spark or flame in the vicinity of the battery.
- Use the Basement Watchdog control unit for charging a LEAD-ACID battery only. **DO NOT** use the control unit for charging dry-cell batteries that are most commonly used with home appliances.
- Be sure the area around the battery is well-ventilated.
- When cleaning or adding water to the battery, first fan the top of the battery with a piece of cardboard or another non-metallic material to blow away any hydrogen or oxygen gas that may have been emitted from the battery.

- **DO NOT** drop a metal tool onto the battery. It might spark or short-circuit the battery and cause an explosion.
- Remove personal metal items such as rings, bracelets, watches, etc. when working with a lead-acid battery. A short circuit through one of these items can melt it causing a severe burn.
- **ALWAYS** remove the charger from the electrical outlet before connecting or disconnecting the battery cables. *Never allow the rings to touch each other.*
- Check the polarity of the battery posts. The POSITIVE (+) battery post usually has a larger diameter than the NEGATIVE (-) post.

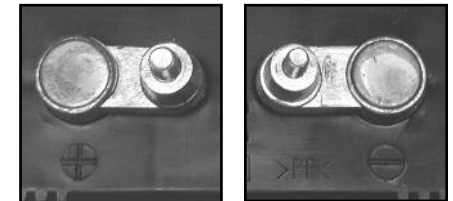

POSITIVE POST HAS LARGER DIAMETER

NEGATIVE POST HAS SMALLER DIAMETER

- When connecting the battery cables, first connect the small ring on the end of the BLACK wire to the NEGATIVE (-) post of the battery, and then connect the large ring on end of the RED wire to the POSITIVE (+) post of the battery.

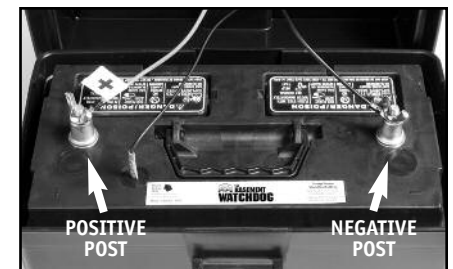

- **ALWAYS** keep the cover secured on the battery box by slipping the tabs through the fittings on the front and back of the box.

#### **⚠ DANGER**

Do not use system to pump flammable or explosive fluids such as gasoline, fuel oil, kerosene, etc.

**DO NOT** use this system in pits handling raw sewage or other hazardous liquids.

## Introduction

The Basement Watchdog combination sump pump system is designed to provide both primary and backup pumping capabilities. The primary pump will operate as long as it is receiving AC power. If the power is interrupted, or more water is coming into the sump than the AC pump can handle, the backup sump pump will begin pumping automatically. The backup system has unique monitoring features that diagnose a problem and sound an alarm. A light on the display panel of the control unit will indicate the cause of the alarm and the corrective action. The two systems have been pre-assembled for easy installation.

For added reliability, the float switches have, not one, but two floats. Should one float fail to operate, the second float automatically activates the pump.

### The Basement Watchdog Sump Pump System includes:

- A 1/2 HP primary pump with a caged dual float switch, and a blue piggyback controller that plugs into the wall outlet
- A black backup pump supported by a bracket
- A black control unit for the backup pump with a battery fluid sensor, a dual float switch, and battery cables
- Two cable ties to secure the wires to the discharge pipe
- A battery cap with a hole to accommodate the fluid sensor
- A battery charger
- A rubber union

### You will also need to supply:

- A Basement Watchdog Big Standby Battery or Maintenance Free (AGM) Standby Battery. **DO NOT** use a Basement Watchdog Emergency Standby Battery (24EP6 or BW-24F) with this system. It will not run the pump as long as the Big Standby or Maintenance Free (AGM) Standby Battery.
- Six quarts of 1.265 specific gravity battery acid. (Not needed if using a maintenance free (AGM) standby battery.)

\*Basement Watchdog standby batteries are specifically designed to work with your battery backup sump pump system. Glenetronics can not guarantee the compatibility of other brands of batteries. For optimal performance the use of a Basement Watchdog standby battery is recommended.

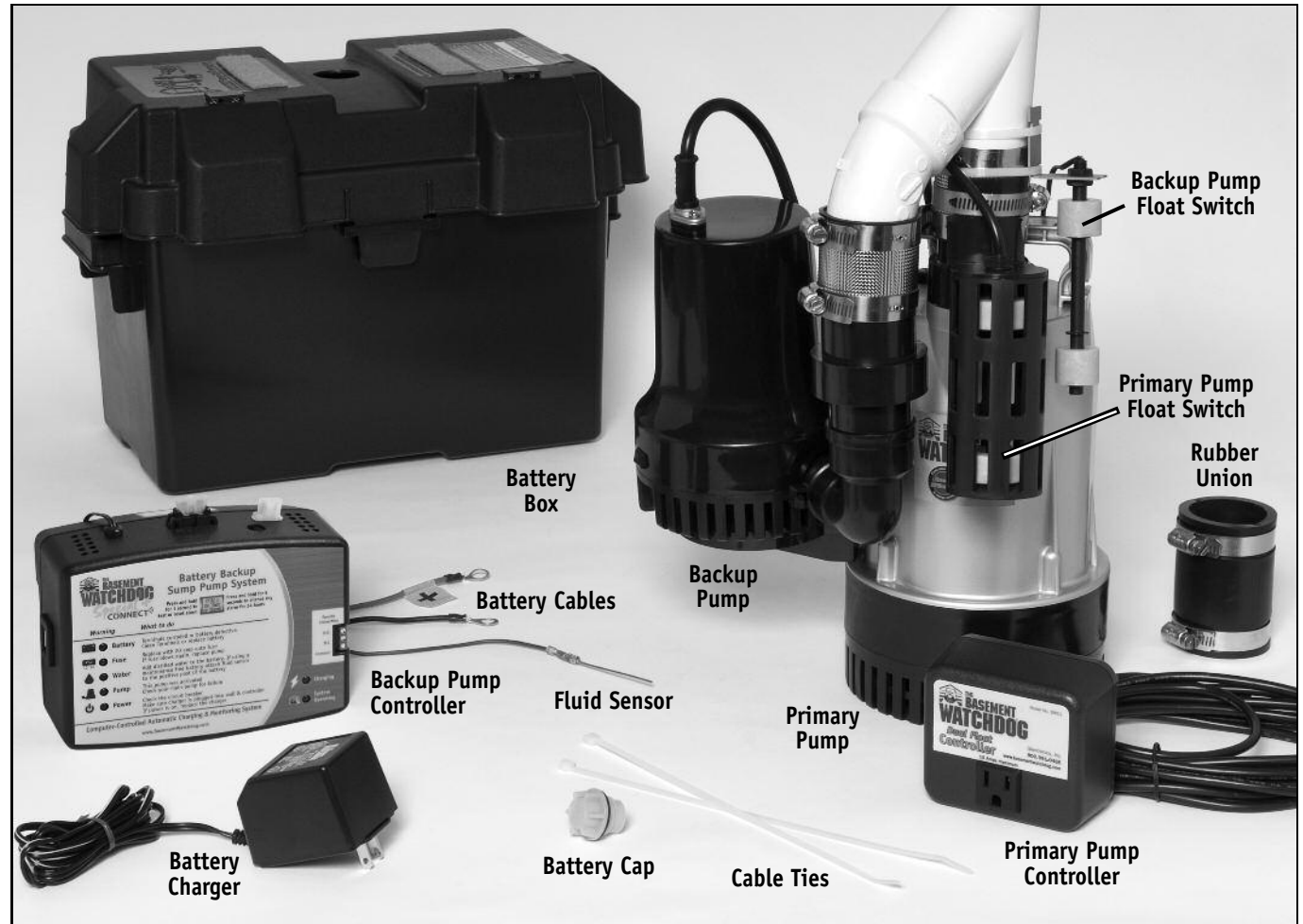

### For some installations you may also need additional items:

- 1-1/2" rigid PVC pipe
- A 1-1/2" PVC pipe connector or a 1-1/2" rubber union
- PVC pipe cleaner and cement



### To connect two batteries you will need:

- Two (2) batteries of same type, age and capacity (so they will have equal power and charge properly). **Do not** use batteries of different types, ages or capacities.
- Another battery box
- Two (2) acid packs to fill the dry batteries. Acid packs are not needed if using maintenance free (AGM) batteries



- A set of battery cables with rings on both ends to connect the two batteries together (available from Glenetronics, Inc.)

## System Specifications

Power supply requirements . . . . 115 volts, 60 Hz  
 AC pump pumping capacity . . . . 3540 GPH @ 10'  
 DC pump pumping capacity . . . . 1850 GPH @ 10'  
 Overall dimensions . . . . . 11" W x 18" H  
 Pump housings and strainers . . . . .

- Primary - Cast iron/cast aluminum housing with non-corrosive strainer
- Backup - Non-corrosive housing and strainer

## Installing the Pipe and Pump

The Basement Watchdog combination system is compact and will fit in a sump pit as small as 12" wide and 14" high (the size of a 5 gallon bucket). It measures 18" inches from the bottom of the pump to the top of the Y-connector where it will be attached to the discharge pipe.

Use a pit that conforms to all local codes, and check the code to see if a gate valve or ball valve is required.

The path of the existing vertical discharge pipe to an exterior wall should have the shortest path with the fewest turns. The more turns will reduce the pumping capacity. The horizontal discharge pipe must be positioned in a downward slope when it exits the building, so any remaining water will drain away. Failure to do this will prevent water from exiting the pit and damage the pump if the line freezes. (see Diagram A)

The system should be placed on a flat surface

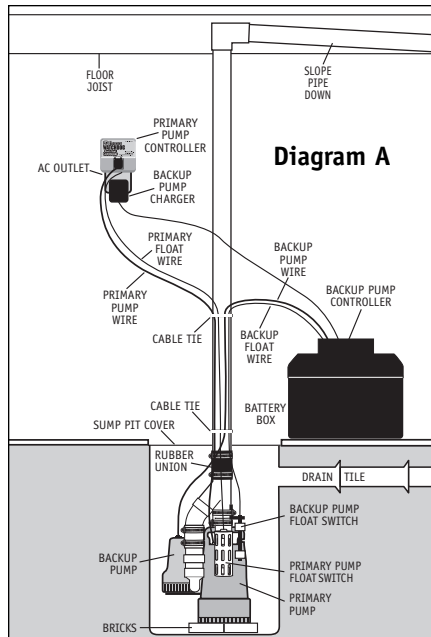

free from dirt and debris. If the bottom of the sump pit is not clean, remove as much of the debris as possible. You should place a pump stand or bricks on the floor of the sump pit to raise the pump above the debris.

If you are replacing an old sump pump, **unplug the pump from the outlet.**

1. Remove the check valve or rubber union. **Discard the check valve. The Basement Watchdog system contains built-in check valves, so the old valve will not be needed.** If the existing system is installed without a check valve or rubber union, saw the pipe apart above the sump pit. (Refer to the diagram in step #3.)
2. Remove the old pump from the pit, and unscrew the pipe and pipe adapter from the pump.
3. Measure the distance from the bottom of the sump pit (or from the top of the bricks in the sump pit) to the end of the discharge pipe. Subtract 19 inches (the height of the pump system + 1 inch). Cut a piece of 1-1/2" rigid PVC pipe to that length.
4. (a) Connect this piece to the discharge pipe by cementing the two pieces together with a 1-1/2" PVC pipe connector. (Follow the instructions on the PVC pipe cleaner and cement.) OR, (b) connect the two pieces of pipe together with a rubber union.
5. Remove the pump assembly by grabbing the handle of the silver pump and lifting up. **DO NOT** lift the assembly by grabbing any of the pipes. They may break.
6. Separate the attached cords and controllers and place them next to the pump system. **BE SURE THE CORDS AND CONTROLLERS DO NOT FALL INTO THE SUMP PIT DURING THE INSTALLATION.**
7. Loosen the hose clamps on the enclosed rubber union, and slide the union up on the discharge pipe until it is even with the bottom of the pipe.
8. Lift the combination system by the handle on the primary pump and lower it into the sump pit. Make sure it is level.
9. Inspect the two float switches. They should both be vertical and positioned so that they move smoothly without hitting the pump or the wall of the sump pit.

10. Inspect all of the screws on the hose clamps of the no hub couplings (primary and backup pumps). They should be tight.

11. Position the top of the pump system pipe so it is directly below the discharge pipe. Slide the rubber union down until half of the rubber union is covering the pump pipe, and the other half is covering the bottom of the discharge pipe. Tighten the hose clamp screws securely.

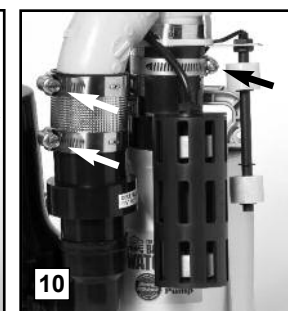
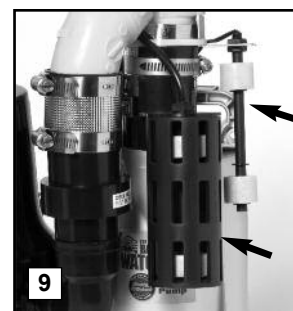
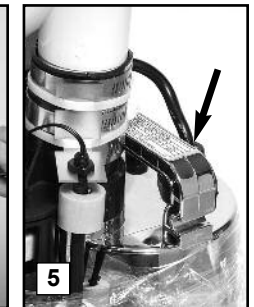
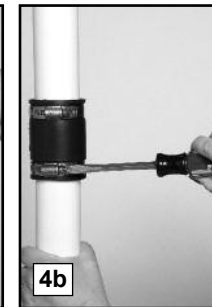
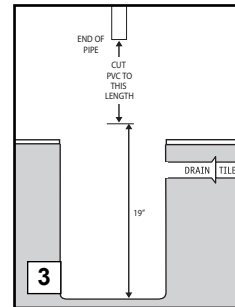
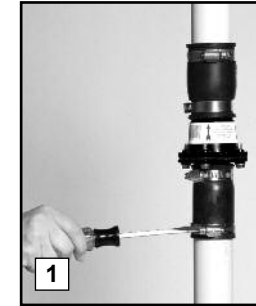



## Preparing the Battery

The Basement Watchdog Big Standby battery has been designed to run this system for 60 hours, based on a 10% duty cycle. However, most of the time the pump will turn on and off, and this battery will run the pump intermittently for days. In addition, the unique materials in the Basement Watchdog Standby batteries enable them to last longer in standby service.

*NOTE: The battery will not run the primary pump.*

### CAUTION

- The use of automotive batteries is NOT recommended. Automotive batteries are not designed for this application. They will only run the pump for a short time and will have a shorter life than a standby battery.
- The battery fluid sensor and cap are designed to fit the Basement Watchdog batteries. Measuring the battery fluid is one of the most important features of the system; since about 80% of backup sump pump failures are the result of a battery that has dried out.
- Basement Watchdog standby batteries are specifically designed to work with your battery backup sump pump system. Gentrionics can not guarantee the compatibility of other brands of batteries. For optimal performance the use of a Basement Watchdog standby battery is recommended.

### ⚠ DANGER

**DO NOT** insert the fluid sensor into any battery except a Basement Watchdog battery. **DO NOT** use the enclosed battery cap on any battery except a Basement Watchdog battery. **DO NOT** drill a hole in the cap or the top of another brand of battery to accommodate the fluid sensor. Batteries emit explosive gases, which can cause serious injury or death.

### PREPARING THE BASEMENT WATCHDOG STANDBY BATTERY

The Basement Watchdog batteries are shipped dry (without acid) so they never lose power before you take them home. A battery is activated when the acid is added, and then it slowly begins to deteriorate as it ages. By adding

the acid just before use, the battery will always be fresh. Use 1.265 specific gravity battery acid to fill the battery. It is available where you purchased the battery.

*NOTE: Basement Watchdog batteries now come in two configurations. The tops of the batteries look different, and the directions for filling the batteries and connecting the fluid sensor will vary slightly. If the top of your battery looks like photo A, follow the instructions on this page. If the top of your battery looks like photo B on page 5, follow the instructions on page 5.*

### ⚠ DANGER/POISON

Contains sulfuric acid. Wear eye and clothing protection. If battery acid contacts skin or clothing, wash immediately with soap and water. If acid enters eyes, flush with water for 15 minutes, and get prompt medical attention. Review the safety instructions on page 1.

### TO FILL THE BATTERY

1. Remove the cover of the battery box by pushing the tabs on the front and back of the box and lifting up. Place the battery box on the floor. Place the dry (unfilled) battery into the battery box.
2. Remove the foil seal on the top of the battery.
3. Carefully push in the perforated tab at the top of the acid pack. Lift up the large tab and pull out the dispensing hose. Hold the hose upright above the pack and squeeze the hose forcing all the acid back into the pack.
4. Position the acid pack and battery as shown at the right. Pinch the end of the hose together and cut off the tip. Insert the end of the hose into each cell. Control the flow by pinching the hose with thumb and forefinger. **Fill each cell of the battery to a level just covering the battery plates, and then go back and top off each cell equally. It is important to have all of the cells filled equally or the battery will not operate properly.** The acid should reach a level about 1/4" below the cap rings. You may top off each cell with a little distilled water, if necessary. **DO NOT OVERFILL THE BATTERY.** (Diagram B)

A newly filled battery will sometimes require additional acid after about ten minutes. Re-

examine the fill level and add additional acid, if necessary. The battery acid may bubble at this time and give off a sulfur-like smell, but this is normal. After the battery has been filled, screw the caps on the top of the battery.

The battery will be charged 70%-80% 30 minutes after adding the acid. The system will then finish charging the battery. During this time the alarm may sound.

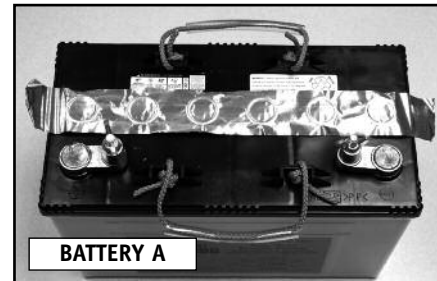

BATTERY A

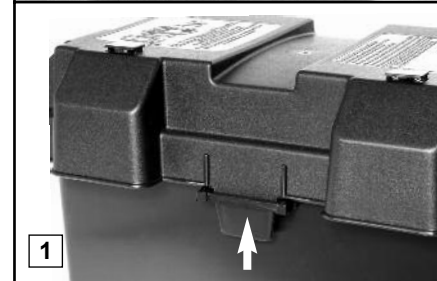

1



2



3



4

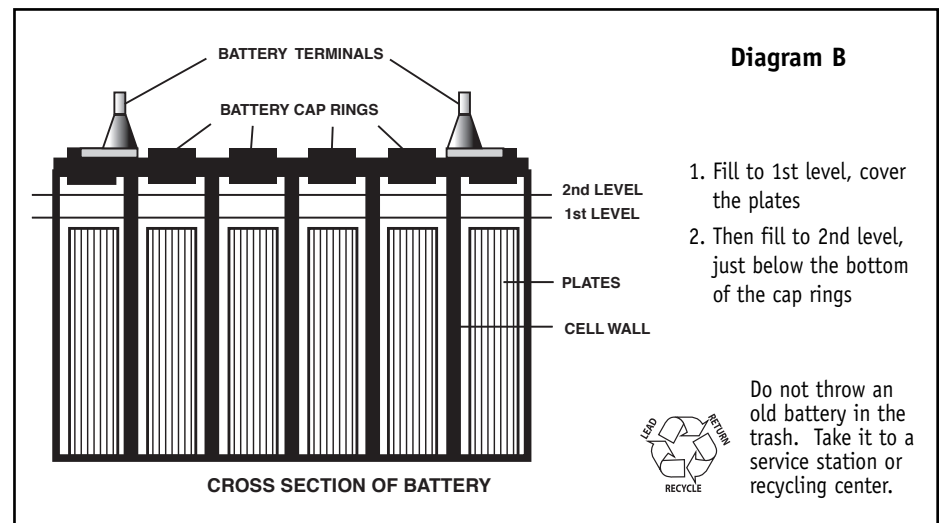

## CAUTION

When you fill the battery for the **FIRST** time, it will be the **ONLY** time you add acid to the battery. In the future, when the fluid level is low, add distilled water to the cells. **NEVER** add more acid.



If your battery looks like the battery above, follow these directions.

1. Remove the cover of the battery box by pushing the tabs on the front and back of the box and lifting up. Place the battery box on the floor. Place the dry (unfilled) battery into the battery box.
2. Remove the two battery caps by carefully prying them up with a screwdriver. Place the screwdriver in the groove in the middle of the cap on the top of the battery. **DO NOT** lift the cap by prying it up from the groove on the side of the battery. It may damage the vent.
3. Carefully push in the perforated tab at the top of the acid pack. Lift up the large tab and pull out the dispensing hose. Hold the hose upright above the pack and squeeze the hose forcing all the acid back into the pack.
4. Position the acid pack and battery as shown at the right. Pinch the end of the hose together and cut off the tip. Insert the end of the hose into each cell. Control the flow by pinching the hose with thumb and forefinger. **Fill each cell of the battery to a level just covering the battery plates, and then go back and top off each cell equally. It is important to have all of the cells filled equally or the battery will not operate properly.** The acid should reach a level about 1/4" below the cap rings. You may top off each cell with a little distilled water, if necessary. **DO NOT OVERFILL THE BATTERY.** (Diagram B)

A newly filled battery will sometimes require additional acid after about ten minutes. Reexamine the fill level and add additional acid, if necessary. The battery acid may bubble at this time and give off a sulfur-like smell, but this is normal. After the battery has been filled, press the two caps on the top of the battery.

The battery will be charged 70%-80% 30 minutes after adding the acid. The system will then finish charging the battery. During this time the alarm may sound.

## CAUTION

When you fill the battery for the **FIRST** time, it will be the **ONLY** time you add acid to the battery. In the future, when the fluid level is low, add distilled water to the cells. **Never** add more acid.

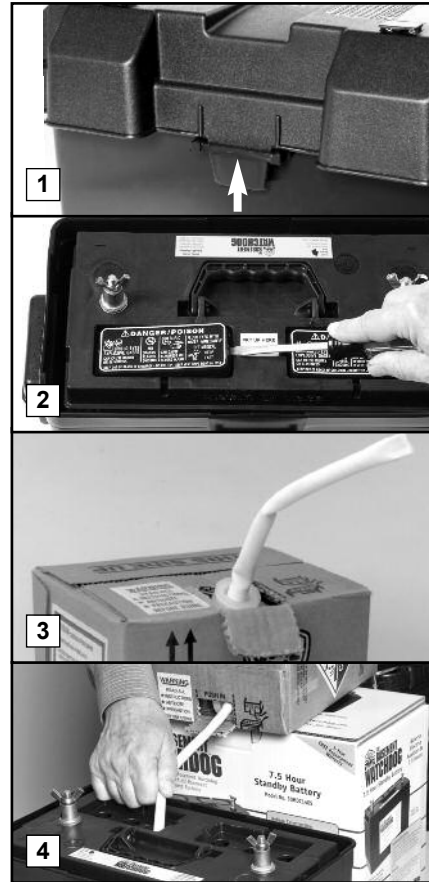

This backup system will also accommodate a maintenance-free battery, eliminating the need to fill the battery. The fluid sensor is not needed when using maintenance-free batteries. However, you **MUST** attach the fluid sensor to the positive post of the battery to silence the fluid alarm.

## Battery Maintenance

Measuring the battery fluid level is one of the most important features of the system. It is important to check the battery fluid levels at least once every 4-6 months. Detailed instructions on adding distilled water to the battery can be found within the **Understanding the Warnings & Alarms** section of this manual (page 9, ③ Water). If you are not using a Basement Watchdog standby battery, you cannot use the battery fluid sensor. You will need to attach the fluid sensor to the **POSITIVE (+)** post of the battery or the alarm will sound continuously. The system will **NOT** warn you if the fluid level is low in this configuration. You will need to check your battery every couple of months to see if it needs water. If the battery dries out, the system will not work. If you are using a maintenance free battery or sealed AGM battery you will also need to attach the fluid sensor to the **POSITIVE (+)** post of the battery or the alarm will sound continuously.

## System Connections

### ⚠ DANGER

**Risk of electrical shock or battery explosion, which can cause serious injury or death. Unplug the main AC pump to avoid electrical shock. Wear eye protection. Work in a well-ventilated area. Do not smoke or allow a spark or flame in the vicinity of the battery. Avoid dropping metal tools on the battery. If battery acid contacts eyes, flush with**

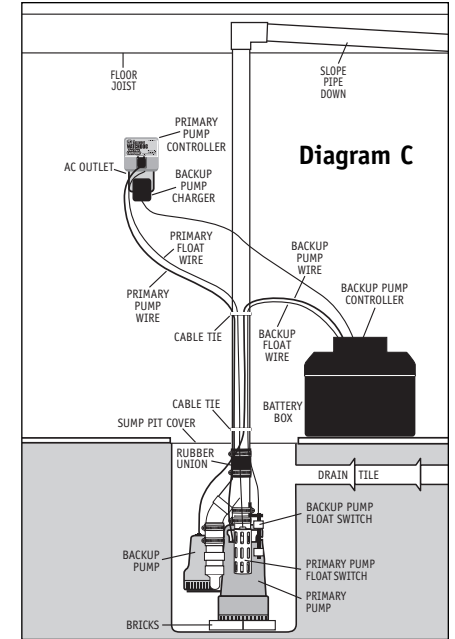
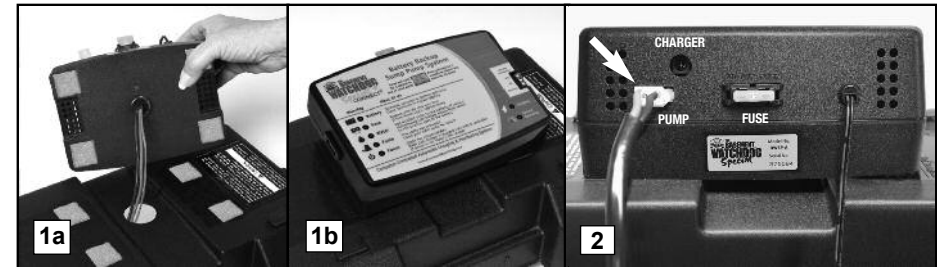

**water for 15 minutes and get prompt medical attention. Review the safety instructions on page 1.**

## MOUNTING THE CONTROLLER

When you position the battery with the control unit on the top, be sure the charger cord will reach the AC power outlet, and the pump cable and float switch will reach the bottom of the sump. Position the unit in a well-ventilated area. (Diagram C)

1. **Mounting the backup control unit:** (a) Thread the wires on the backup controller through the hole in the top of the battery box. (b) Secure the controller to the top of the battery box by lining up the Velcro strips and pressing them together.

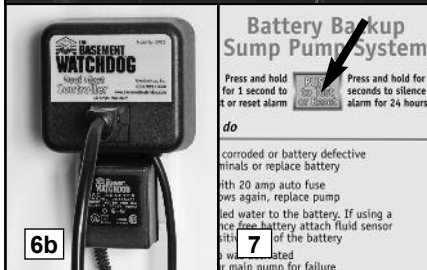
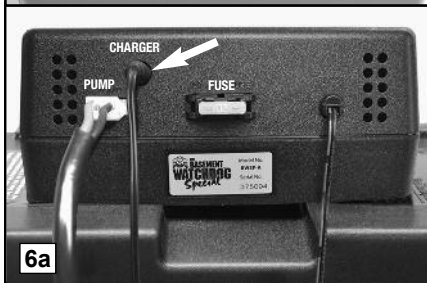
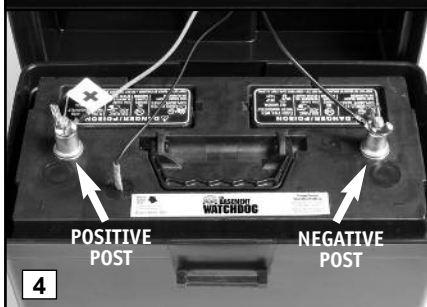
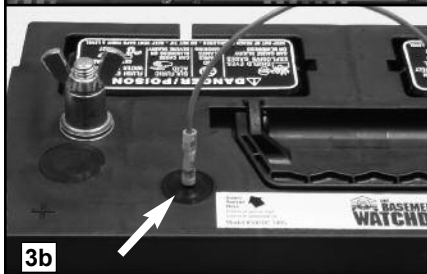
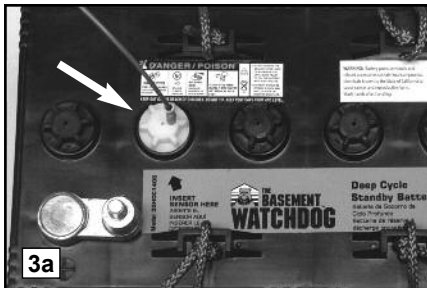

2. **Connecting the backup pump:** Remove the security tag from the pump and plug the pump wires into the pump connector on the back of the control unit.
3. **Installing the battery fluid sensor:** Remove the cover of the battery box and fan the area around the top of the battery with a piece of cardboard (or another non-metallic material) to remove any hydrogen or oxygen gas that may have been emitted from the battery. (a) If you have battery A, replace the battery cap that is 2nd from the POSITIVE (+) post of the battery with the battery cap that is provided in the Basement Watchdog package. An arrow on the top of the battery marks this position. There are two holes in the battery cap. Insert the fluid sensor in the hole that is off-center on the top of the cap. *Do not glue the sensor into the cap.* (b) If you have battery B, a hole has been molded into the top of the battery to accept the fluid sensor rod. The sensor hole is marked by the label on top of the battery. Hold the sensor straight and press it firmly into the hole all the way up to the connector. Do not bend the sensor rod.

**If you are not using the Basement Watchdog battery, you cannot use the battery fluid sensor. However, you must attach the sensor to the POSITIVE (+) post of the battery or the alarm will sound continuously. The Basement Watchdog sump pump system will not warn you if the fluid level is low in this configuration. You will need to check your battery every couple of months to see if it needs water. If the battery dries out, the system will not work. If you are using a maintenance free battery or sealed AGM battery you will also**

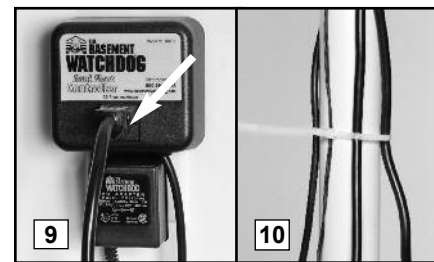
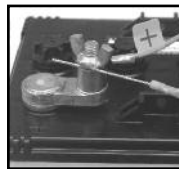

**need to attach the fluid sensor to the POSITIVE (+) post of the battery or the or the alarm will sound continuously.**

4. **Connecting the battery:** Remove the wing nuts from the battery terminals. Remove the security tag from the battery cables. Attach the battery cables to the battery...the BLACK wire to the NEGATIVE (-) post, and then the RED wire to the POSITIVE (+) post. Replace the wing nuts and tighten. *Note: Connecting the cables to the wrong posts will damage the controller.*
5. **Connecting two batteries:** If you are connecting two batteries to the system, before you replace the wing nuts, connect the additional cable to the two batteries....the BLACK wires to the POSITIVE (+) posts and the WHITE wires to the NEGATIVE (-) posts of each battery. **NEVER** attach one end of the positive wire to the positive post and the other end of the positive wire to the negative post on the other battery.
6. **Connecting the charger:** Immediately plug the charger into the charger jack on the back of the control unit, then into an AC outlet on the wall.
7. If the pump alarm is sounding, press the YELLOW button to silence the alarm.
8. Replace the cover on the battery box.
9. **Connecting the primary pump:** Plug the piggyback controller into a properly grounded 3-prong outlet. Then plug the primary pump into the receptacle on the controller.
10. For a neater installation, secure the cables from the controllers to the discharge pipe in a couple places with the additional cable ties. Make sure the wires are not touching each other or overlapping each other.
11. After the initial installation, be sure to check each pump for proper operation. To check the primary pump, fill the sump with water and observe the pump through several full cycles. The primary pump should run for 10 seconds after the lower float drops. To check the operation of the backup pump, manually raise the backup float and let it go. The backup pump will run for approximately 25 seconds. After the backup pump has stopped, push the yellow button.
12. A pit cover is recommended for all installations as a safety measure, and to prevent debris from falling into the pit. Place

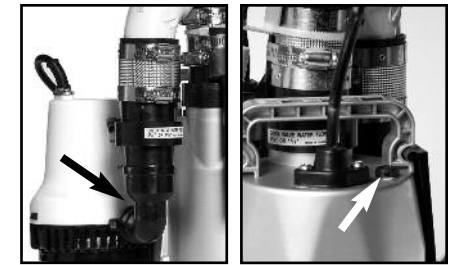

the cover on top of the pit making sure not to pinch or crimp the pump wires with the cover. The pit cover usually has an existing hole that will allow the cords to be passed through it, or you can drill a hole in the cover.

## Product Operation

The dual float switch on the primary pump contains two large floating rings enclosed within a protective cage. Water will lift the bottom float by 1/4", which will activate the pump. If for any reason the lower float does not activate the pump, the water will rise to the second float, and it will activate the pump. As the pump evacuates the water from the pit, the floats will drop. The pump will run for an additional 10 seconds to extend the cycle after the lower float drops. The blue controller for the primary pump powers this switch.

During a power outage, or when more water is entering the sump than the primary pump can handle, the backup pump will automatically begin pumping. It also has a dual float switch, so if one float fails to activate the pump, the second float will activate the pump as soon as the water reaches that level. As the water recedes below the float switch, a timer in the control unit will run the pump an additional 25 seconds to evacuate the pit.

While the pumps are active, water will come out of the 1/8" hole that is located on the top of the main pump, and out of the hole in the elbow of the backup pump. This is normal. The holes are needed to prevent an air lock within the system. **DO NOT** obstruct the holes or an air lock may prevent the system from activating.

Batteries and sump pumps need maintenance. The control unit on the backup system monitors the battery and power conditions, and sounds an alarm when maintenance is required. Below is an explanation of the warnings and alarms.



**THE BASEMENT WATCHDOG Special+ CONNECT**

**Battery Backup Sump Pump System**

Press and hold for 1 second to test or reset alarm

PUSH to Test or Reset

Press and hold for 5 seconds to silence any alarm for 24 hours

Warning	What to do
① <b>Battery</b>	Terminals corroded or battery defective Clean Terminals or replace battery
② <b>Fuse</b>	Replace with 20 amp auto fuse If fuse blows again, replace pump
③ <b>Water</b>	Add distilled water to the battery. If using a maintenance free battery attach fluid sensor to the positive post of the battery
④ <b>Pump</b>	This pump was activated Check your main pump for failure
⑤ <b>Power</b>	Check the circuit breaker Make sure charger is plugged into wall & controller If power is on, replace the charger

Remote Connection  
N.O.  
N.C.  
Common

⑥ **Charging**

⑦ **System Operating**

Computer-Controller Automatic Charging & Monitoring System

## Understanding the Warnings & Alarms

The control unit for the Basement Watchdog backup pump features a series of warning lights that pinpoint potential problems. In addition, an alarm sounds to alert you to the problem. In some cases the lights and alarm will go off automatically when the problem has been solved. In others, the YELLOW button must be pushed to reset the alarm. Refer to the table below for a quick review of the features and their corresponding alarm status.

Warning	Alarm can be silenced before problem is corrected	Alarm shuts off automatically when the problem is corrected
Battery	No	No, must push YELLOW button
Fuse	No	Yes
Water	Yes	Yes
Pump	Yes	No, must push YELLOW button
Power	Yes	Yes

## SILENCING THE ALARM DURING AN EMERGENCY

Refer to the diagram of the control panel above.

The Basement Watchdog backup system allows you to silence some of the alarms during an emergency, however the warning lights will remain on until the problem is corrected.

- Press the YELLOW button on the front of the control panel for one (1) second to reset the "Pump" alarm, and silence the "Water" and "Power" alarms for two (2) minutes.
- Press the YELLOW button for five (5) seconds to silence these alarms for 24 hours. A brief buzzing sound will notify you that the alarms have been silenced. The alarms will automatically reactivate in 24 hours if the warning condition still exists.

### ① Battery

This light and alarm will come on when the control unit detects there is less than ½ hour of pumping power left in the battery, or that the battery is defective. The alarm cannot be silenced, because action needs to be taken to protect your basement. If your battery is more than five (5) years old, replace it. If not, here are several situations that would cause the pump to run the battery for an extended time and

discharge the battery: Check the list below before you replace the battery.

- If the bottom light on the controller is also on, it means that the unit is not receiving AC power. Either the AC power is out, the circuit breaker has blown, or the outlet is bad. When the problem is corrected, the battery should recharge.
- If the fourth light on the controller is also on, check your main pump for failure. The backup pump may have been activated repeatedly if your main AC pump is broken, or you are experiencing heavy rains and your main pump cannot keep up with the inflow of water. You may need to upgrade or replace your main pump. When the problem is corrected, the battery should recharge.
- If no other lights are on, this means the terminals may be corroded, and the battery cannot charge properly. Unplug the charger from the wall outlet. Then, check the battery cables and the battery terminals for corrosion. Clean and tighten them as needed. The procedure is described in the next column and on page 8.
- If the battery terminals have been cleaned and the light is still on, there could be a problem with the controller or the battery. The best way to determine if the battery is the problem is to have it charged and load tested at any local car service station. If the battery is bad and less than one (1) year old, it can be returned to the place of purchase for a replacement (receipt required). If the battery is good, contact Glentronics' service department for further instructions. The phone number is 800-991-0466, option #3.

If the battery alarm goes on while the pump is running and the power is out, you will have a minimum of one-half (1/2) hour of continuous pumping time to replace the battery. (In most cases, the pump does not run continuously, and therefore, you actually have a longer time to replace it.) You will not be able to silence the alarm. Left unattended, the basement will flood. In a severe emergency, if a replacement battery is not available, you could temporarily use your car battery, or recharge this battery by connecting it to your car battery.

Once the AC power is restored, the battery will

recharge automatically, unless it is old or damaged. The alarm will remain on until the YELLOW button on the front of the control panel is pressed for one (1) second.

In the event that your Basement Watchdog sump pump system has pumped for an extended period of time, the battery may be very depleted. In this condition, when the AC power is returned to the unit, a battery alarm will continue to sound. The battery may need a longer period to recharge.

For a faster recharge, an automotive or marine battery charger can be used to recharge the battery. Follow the manufacturer's instructions and safety information included with the charger.

### WARNING

**When another charger is used, first disconnect the Basement Watchdog charger from the control unit, and then disconnect the control unit from the battery. Using another charger without disconnecting the control unit will destroy the control unit and void the warranty.**

## TO CLEAN THE BATTERY TERMINALS AND CABLES

### DANGER

**Risk of electrical shock or battery explosion, which can cause serious injury or death. Wear eye protection. Work in a well-ventilated area. Do not smoke or allow a spark or flame in the vicinity of the battery. Avoid dropping metal tools on the battery. If battery acid contacts eyes, flush with water for 15 minutes and get prompt medical attention. Review the safety instructions on page 1.**

### REFER TO THE PHOTOS AT RIGHT

1. Unplug the charger from the wall outlet and unplug the blue AC pump controller.
2. Remove the cover of the battery box by pushing in the tabs on the front and back, then lifting up.
3. Fan the area around the top of the battery with a piece of cardboard (or another non-metallic material) to remove any hydrogen or oxygen gas that may have been emitted from the battery.



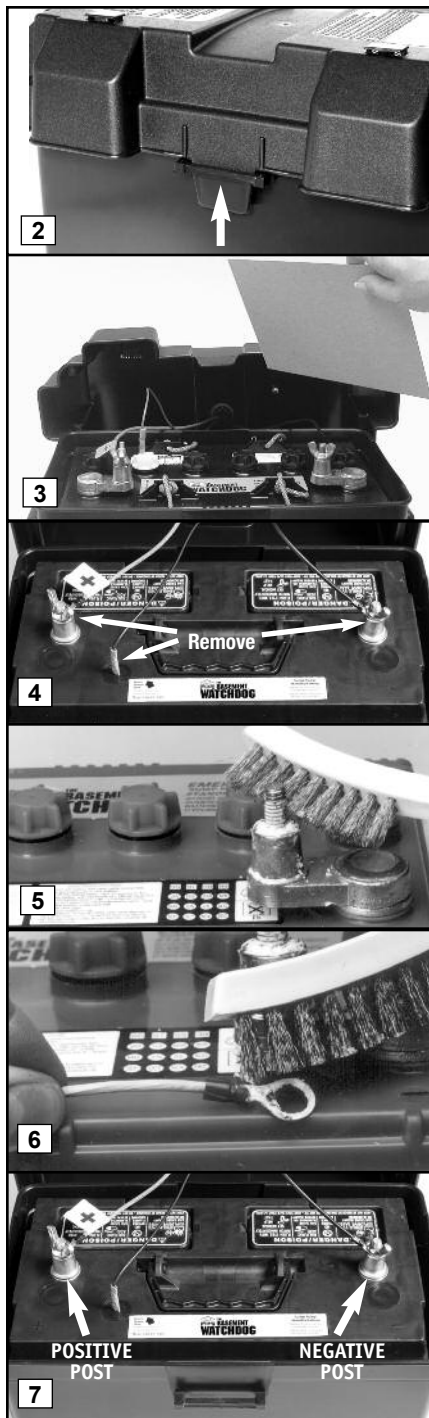

4. Remove the fluid sensor from the battery. Unscrew the wing nuts. Remove the battery cables.
5. Clean the battery posts with a battery terminal cleaner or a wire brush.
6. Clean any corrosion off of the ring connectors on the ends of the battery wires. Use a stiff brush or sandpaper. **DO NOT** apply corrosion resisting sprays or pads to the terminal rings or posts after you have cleaned them, since this could prevent the system from charging properly.
7. Replace the fluid sensor in the top of the battery. Then replace the battery cables, BLACK to the NEGATIVE (-) post and RED to the POSITIVE (+) post. Tighten the wing nuts. Replace the cover on the battery box.
8. Plug the charger and the blue AC pump controller back into the wall outlet.
9. If any of the alarms are sounding, press the YELLOW button on the front of the control panel for one (1) second.



## REPLACING THE BATTERY

### **⚠ DANGER**

Risk of electrical shock or battery explosion, which can cause serious injury or death. Wear eye protection. Work in a well-ventilated area. Do not smoke or allow a spark or flame in the vicinity of the battery. Avoid dropping metal tools on the battery. If battery acid contacts eyes, flush with water for 15 minutes and get prompt medical attention. Review the safety instructions on page 1.

### REFER TO THE PHOTOS AT RIGHT

1. Unplug the charger and the blue AC pump controller from the wall outlet.
2. Remove the cover of the battery box by pushing in the tabs on the front and back, then lifting up.
3. Fan the area around the top of the battery with a piece of cardboard (or another non-metallic material) to remove any hydrogen or

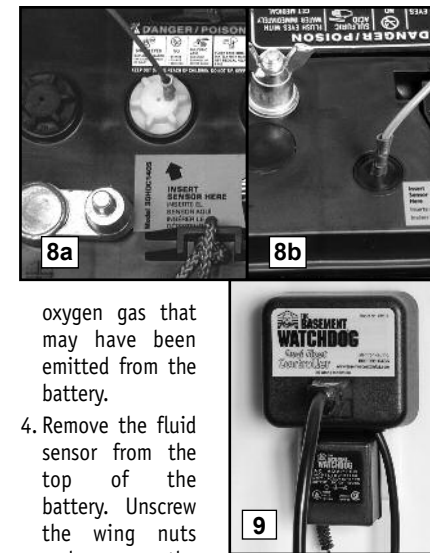
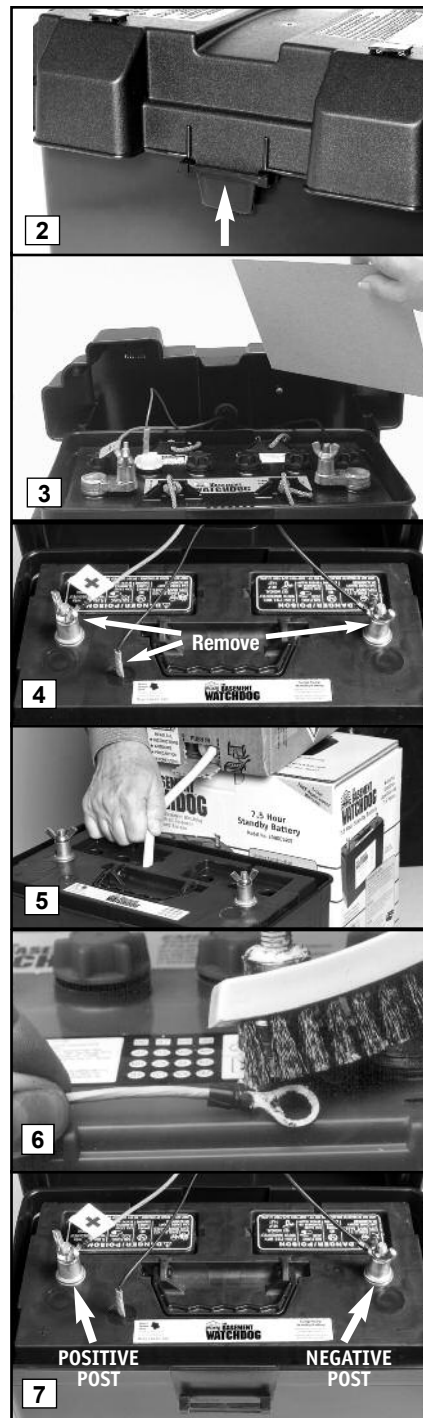

oxygen gas that may have been emitted from the battery.

4. Remove the fluid sensor from the top of the battery. Unscrew the wing nuts and remove the battery cables.
5. Remove the old battery from the battery box and place the new battery in the box. Fill the battery following the instructions on page 4 or 5.
6. Clean any corrosion off of the ring connectors on the ends of the battery wires. Use a stiff brush or sandpaper. **DO NOT** apply corrosion resisting sprays or pads to the terminal rings or posts after you have cleaned them, since this could prevent the battery from charging properly.
7. Replace the battery cables, BLACK to the NEGATIVE (-) post and RED to the POSITIVE (+) post. Tighten the wing nuts.
8. (a) If your battery has six (6) caps on the top, rinse and dry the cap with the extra hole from the old battery to remove any residue. Replace the battery cap in the cell that is 2nd from the POSITIVE post with the cap from the old battery. Insert the fluid sensor in the cap. (b) If your battery has two caps, each covering three (3) battery cells, simply insert the fluid sensor in the top of the battery next to the arrow. Replace the cover on the battery box.
9. Plug the charger and the blue AC pump controller back into the wall outlet.
10. If any of the alarms are sounding, press the YELLOW button on the front of the control panel for one (1) second.

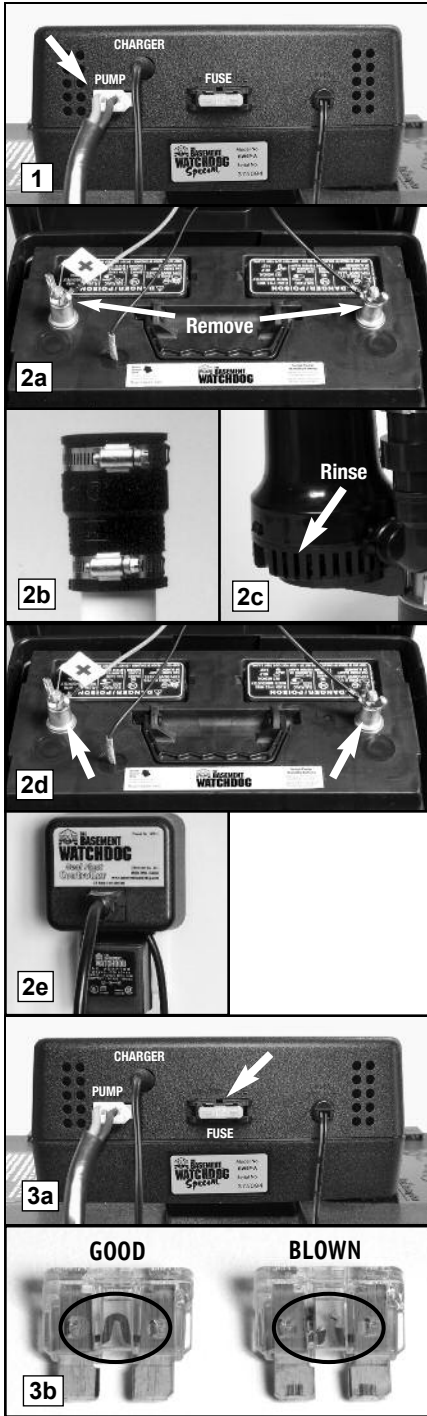

## ② Fuse

**⚠ DANGER**

Unplug the main AC pump before servicing the backup pump to avoid electric shock. Failure to do so could cause serious injury or death.

This alarm indicates that the 20 amp safety fuse on the back of the control unit has blown. This can be the result of a clogged pump motor, or pump wires that have been shorted out. To determine the problem:

*REFER TO THE PHOTOS AT LEFT*

1. Check the pump plug in the back of the unit to make sure it is firmly connected. Check the pump wires to make sure they are connected securely to the pump plug. Check the rest of the pump wires for any possible breaks.
2. If the pump wires are intact, the pump may be clogged. (a) Disconnect the charger from the wall outlet, and disconnect the battery cables. (b) Release the union and remove the pumps by the handle on the primary pump. (c) Clear any debris from the strainer, and then reconnect the pump to the discharge pipe. (d) Connect the control unit, and the battery cables to the battery...the BLACK wire to the NEGATIVE (-) post, and then the RED wire to the POSITIVE (+) post. Tighten the wing nuts on the battery posts. (e) Plug the charger back into the wall outlet.
3. (a) Check the DC fuse by pulling it out of the fuse holder. (b) If the wires are burned and broken, replace the fuse with a 20 amp DC safety fuse. If the fuse blows again, unplug the computer control unit from the wall and disconnect the battery cables from the battery. Then call Glentronics technical support for instructions at 800-991-0466, option #3. You may need to replace the pump.
4. Plug the main AC pump back into the wall outlet.

## ③ Water

**⚠ DANGER**

Risk of electrical shock or battery explosion, which can cause serious injury or death. Wear eye protection. Work in a well-ventilated area. Do not smoke or allow a spark or flame in the vicinity of the battery. Avoid dropping metal tools on the battery. If battery acid contacts eyes, flush with water for 15 minutes and get prompt medical attention. Review the safety instructions on page 1.

*REFER TO THE PHOTOS AT RIGHT*

- If this warning light and alarm are on, you need to add distilled water to the battery. Battery fluid levels should be checked once every four months.
1. Unplug the charger and the blue AC pump controller from the wall outlet.
  2. Remove the cover of the battery box by pushing in the tabs on the front and back, then lifting up.
  3. Fan the area around the top of the battery with a piece of cardboard (or another non-metallic material) to remove any hydrogen or oxygen gas that may have been emitted from the battery.
  4. Then unscrew the wing nuts and remove the battery cables and the fluid sensor from the battery.
  5. Remove the battery caps. Add distilled water to each cell. If distilled water is not available, tap water with a low mineral content may be used. Well water is not recommended. **NEVER ADD MORE ACID.** Fill the battery to level 2 as shown in Diagram B on page 4. (The Basement Watchdog battery filler will automatically fill the level to the correct height. See enclosed order form.)
  6. Replace the battery caps. Replace the fluid sensor in the hole on the top of the battery. Be sure the fluid sensor is positioned in the 2nd cell from the positive post. The hole is marked with an arrow. Replace the battery cables...the BLACK wire to the NEGATIVE (-)

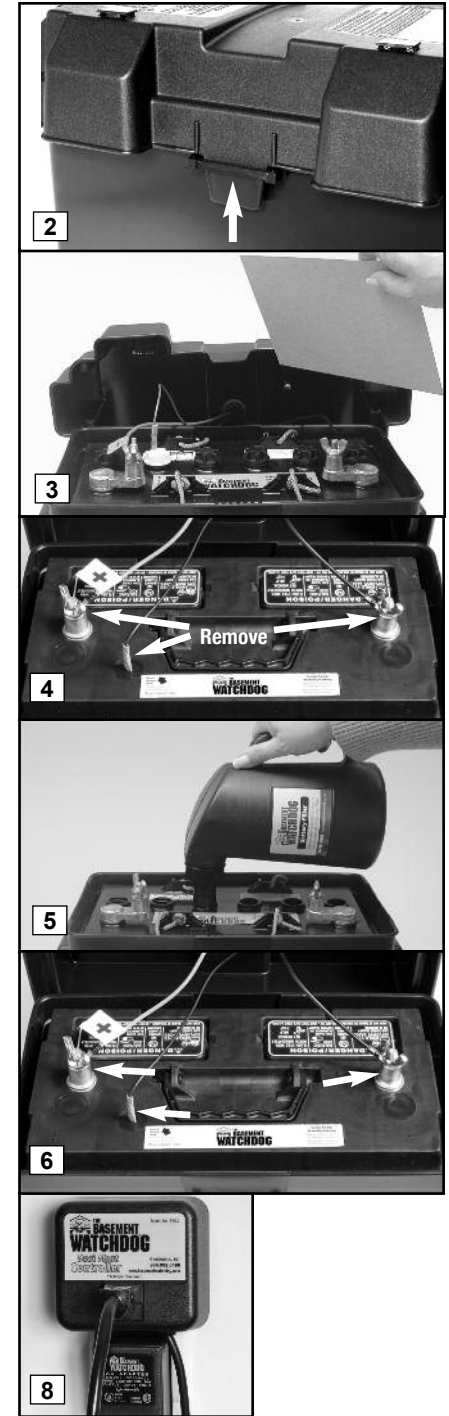

post, and the RED wire to the POSITIVE (+) post. Replace the wing nuts and tighten.

7. Replace the cover on the battery box.
8. Plug the charger and the blue AC controller back into the outlet.
9. If any of the alarms are sounding, press the YELLOW button on the front of the control panel for one (1) second.

#### ④ Pump

When the water rises in the sump pit and activates the float switch, the pump will begin pumping, and the "Pump was activated" light and alarm will turn on. Try to determine what caused the system to activate.

- Check the main AC pump for failure. It may not be working, the float switch may be stuck, or it may be too small to handle the inflow of water.
- Make sure the check valve is working
- Make sure the discharge pipe is not clogged or frozen
- If the power was out, the backup pump was automatically activated and protected your basement. You need to push the YELLOW button on the front of the control panel to silence the alarm.

#### REPLACING THE BACKUP PUMP

Before you begin this process you will need a new backup pump. You may also want to change the check valves at this time. The backup pump uses a 1-1/4" check valve, the primary pump uses a 1-1/2" check valve. (See parts list on page 13.)



#### **⚠ DANGER**

**Risk of electrical shock or battery explosion, which can cause serious injury or death. Wear eye protection. Work in a well-ventilated area. Do not smoke or allow a**

**spark or flame in the vicinity of the battery. Avoid dropping metal tools on the battery. Review the safety instructions on page 1.**

**YOU WILL BE DISCONNECTING ALL THE WIRES. BE SURE THEY DO NOT FALL INTO THE SUMP PIT. SEE DIAGRAM ON PAGE 12 FOR PARTS DESCRIPTION.**

#### REFER TO THE PHOTOS AT RIGHT

1. Unplug the primary pump from the blue controller.
2. Remove the charger plug from the back of the black controller.
3. Unplug the backup pump from the back of the black controller.
4. Remove the sensor from the battery.
5. Remove the battery wires from the battery terminals. **Be sure they do not touch each other while one is connected to the battery.**
6. Slowly loosen the rubber union on the top of the combination pump assembly to separate the pipes. The water trapped in the pipe will pour out into the sump as the rubber union is loosened.
7. Separate the pump assembly from the rubber union and lift it out of the sump by the handle on the primary pump.
8. Turn the assembly up side down over the sump pit to allow the remaining water in the system to drain.
9. Loosen the screws on the no-hub connector on the elbow of the backup pump.
10. Unscrew the screw on the bottom of the pump bracket with a Phillips head screwdriver, and lift the pump off of the bracket. Then pull the pump down out of the no-hub connector.
11. Unscrew the check valve on the elbow of the backup pump. Now reverse the process.
12. Screw the check valve on to the new pump. (You can use the existing check valve, or preferably replace it with a new one.)

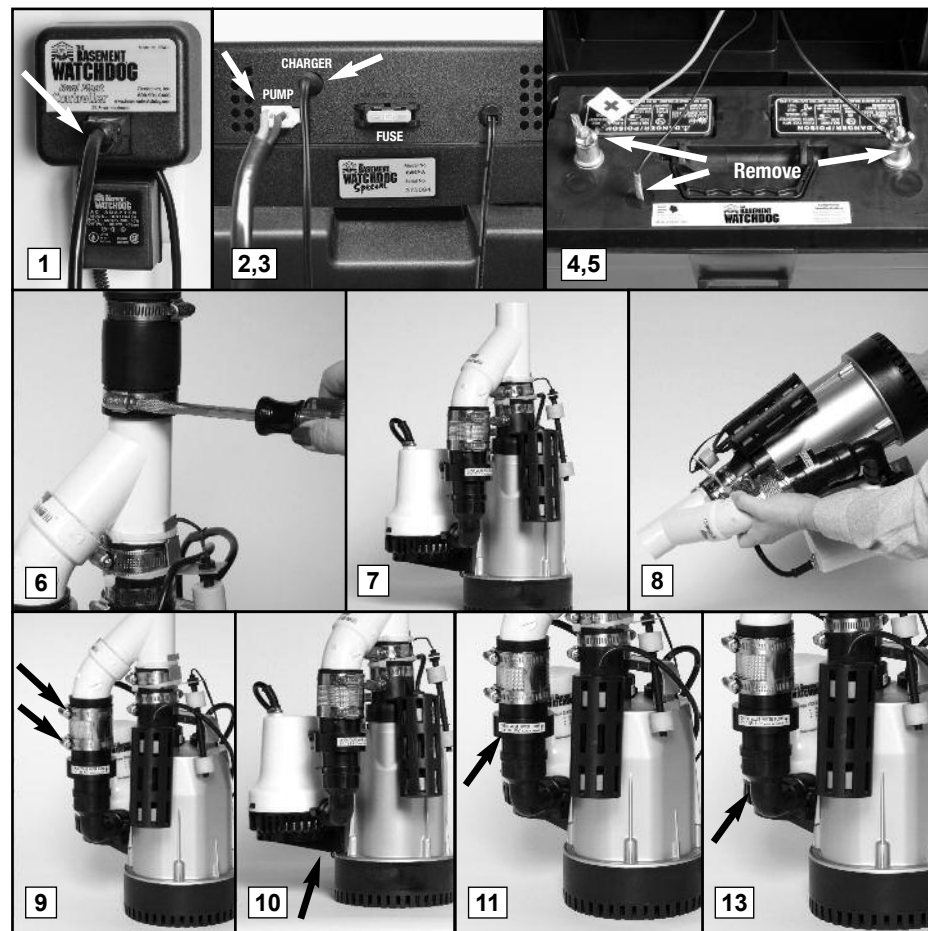

13. **You must drill a 1/8" hole in the elbow of the new pump to prevent an air lock in the system. An air lock will prevent the pump from operating. Drill the hole on a downward slope below the check valve on the elbow.**
14. Push the pump and check valve back up into the no-hub connector, and place the pump on the pump bracket.
15. Screw the pump onto the bracket.
16. Tighten the hose clamp on the no-hub connector.
17. Lower the pump system back into the sump pit.

18. Connect the top of the system to the rubber union and tighten the hose clamp.
19. Connect the battery cables to the battery terminals, BLACK to the NEGATIVE (-) post, and RED to the POSITIVE (+) post.
20. Insert the fluid sensor into the top of the battery.
21. Plug the backup pump into the back of the black controller.
22. Plug the charger into the back of the black controller.
23. Plug the primary pump into the blue controller.

## REPLACING THE PRIMARY PUMP

Before you begin this process you will need a new AC pump. You may also want to change the check valves at this time. The backup pump uses a 1-1/4" check valve, the primary pump uses a 1-1/2" check valve. (See parts list on page 13.)



### **⚠ DANGER**

**Risk of electrical shock or battery explosion, which can cause serious injury or death. Wear eye protection. Work in a well-**

**ventilated area. Do not smoke or allow a spark or flame in the vicinity of the battery. Avoid dropping metal tools on the battery. Review the safety instructions on page 1.**

**YOU WILL BE DISCONNECTING ALL THE WIRES. BE SURE THEY DO NOT FALL INTO THE SUMP PIT. SEE DIAGRAM ON PAGE 13 FOR PARTS DESCRIPTION.**

### REFER TO THE PHOTOS BELOW

1. Unplug the primary pump from the blue controller.
2. Remove the charger plug from the back of the black controller.
3. Unplug the backup pump from the back of the black controller.

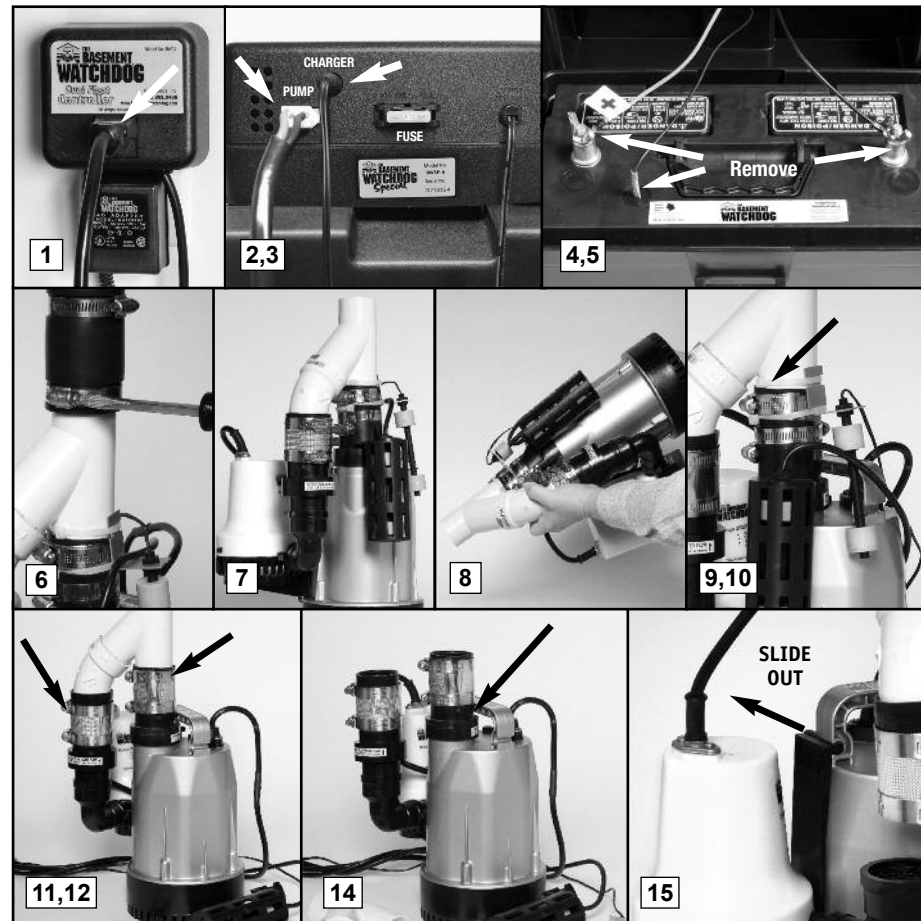

4. Remove the sensor from the battery.
5. Remove the battery wires from the battery terminals. **Be sure they do not touch each other while one is connected to the battery.**
6. Slowly loosen the rubber union on the top of the combination pump assembly to separate the pipes. The water trapped in the pipe will pour out into the sump as the rubber union is loosened.
7. Separate the pump assembly from the rubber union and lift it out of the sump by the handle on the primary pump.
8. Turn the assembly up side down over the sump pit to allow the remaining water in the system to drain.
9. Loosen the hose clamp on the caged float switch and remove the float switch.
10. Cut the cable ties on the backup float switch and remove it.
11. Loosen the hose clamp on the top of the no-hub connector on the primary pump.
12. Loosen the hose clamp on the top of the no-hub connector on the backup pump.
13. Remove the Y-connector.
14. Unscrew the primary pump check valve.
15. Carefully slide the backup pump and bracket out of the handle of the primary pump. Now reverse the process.
16. Carefully slide the backup pump and bracket into the handle of the new primary pump.
17. Screw in the check valve on the top of the primary pump. (You can use the existing check valve, or preferably replace it with a new one.)
18. Connect the Y-connector to the top of the check valve with the no-hub connector and tighten the hose clamp.
19. Connect the backup pump to the other side of the Y-connector with the other no-hub connector.
20. Replace the caged float switch by tightening it with its hose clamp.
21. Replace the backup pump float switch using 2 new cable ties. Make sure the float moves easily, and will not get hung up on the pump.
22. Lower the pump back into the pit by the handle on the primary pump.

23. Connect the top of the system to the rubber union and tighten the hose clamp.
24. Connect the battery cables to the battery terminals, BLACK to the NEGATIVE (-) post, and RED to the POSITIVE (+) post.
25. Insert the fluid sensor into the top of the battery.
26. Plug the backup pump into the back of the black controller.
27. Plug the charger into the back of the black controller.
28. Plug the primary pump into the blue controller.

### ⑤ Power

There are several causes for power failure. The most common is a power outage by your electric company. During this emergency, the Basement Watchdog system will automatically switch to battery power and protect your basement from flooding.

You can silence the "Power" alarm for 24 hours by pressing the YELLOW button for 5 seconds. The alarm will be silenced, but the light will stay on. The system will continue to operate while the power alarm is silenced. After 24 hours, the alarm will reset automatically.

1. If the power is on in the rest of the house, check the home circuit breaker or fuse box for failure, and correct the problem.
2. Check the charger. Make sure it is securely plugged into the wall outlet. Make sure the power outlet is working.
3. Check the charger plug that fits into the rear panel of the control unit. Make sure it is securely plugged into the control unit.

The control unit must receive 115 volts AC +/- 5% from the AC outlet. Any voltage lower than 110 volts will activate the power failure alarm. Lower voltages can be caused by utility company brown outs or a heavy power draw from other appliances on the same circuit. Reduce the number of appliances on the circuit.

If all the connections are secure and the wall outlet is operating, but the "Power" warning light is still on, replace the charger unit with the Basement Watchdog part number 1015001 from Glentronics at 800-991-0466, option #3.



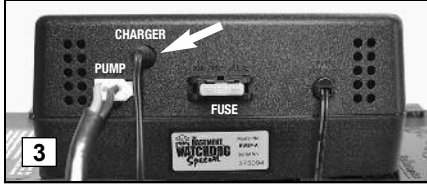

### ⑥ Charging

The Basement Watchdog backup system is equipped with a computer-controlled automatic charging system. The computer is constantly monitoring the battery and will supply a pre-programmed amount of energy to keep your battery at full charge. The "Charging" light will be on or flashing while the battery is charging, and off when it is not charging. If the battery is discharged from extended use, the charger light will remain on until the battery is completely recharged.

### ⑦ System Operating

This light will always be on when there is power coming from either the battery or the outlet.

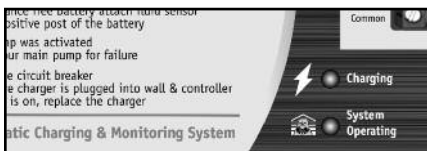

### TEST-RESET-SILENCE BUTTON

To test the pump, press the YELLOW button for 1 second. The pump will run for 2 seconds and then shut off automatically.

To silence an alarm, press the YELLOW button for 1 second. Some alarms cannot be silenced since action needs to be taken to prevent a flood.

To reset the BATTERY or PUMP alarm, press the button for 1 second. To silence them for 24 hours, press the YELLOW button for 5 seconds

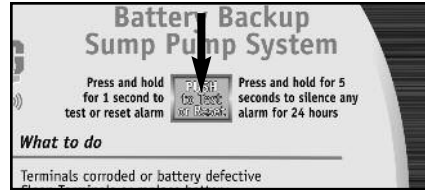

until you hear a buzz. The alarms will automatically re-activate in 24 hours

### TESTING THE BACKUP FLOAT SWITCH

*It is important to manually test the float switch periodically or after any maintenance.*

Lift the float up and let go. This will activate the pump. The control unit will run the pump for approximately 25 seconds so it can empty all the water in the sump pit. If there is no water in the pit, the pump can run dry for this amount of time. The alarm will sound and the PUMP light will go on. After the pump has stopped, push the YELLOW button to silence the alarm. If the YELLOW button is pressed before the pump has stopped, the alarm will go off temporarily. Wait for the pump to stop pumping, and then push the YELLOW button to completely silence the alarm.

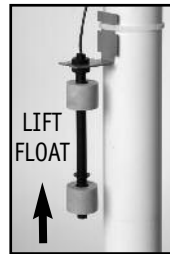

While the pumps are active, water will come out of the 1/8" holes located on the top of the main pump and in the elbow of the backup pump. This is normal. The holes are needed to prevent an air lock within the system. **DO NOT** obstruct the holes or an air lock may prevent the system from activating.

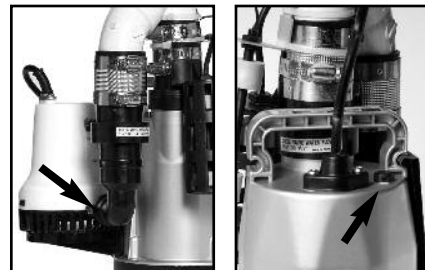

### TESTING THE PRIMARY PUMP FLOAT SWITCH

Lift the float within the cage with a pencil or other non-metallic item and let it drop. The pump will run for an additional 10 seconds after the float returns to the

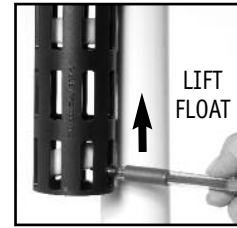

original position. It will not damage the pump to run it for this short time if the sump pit is dry. However, **DO NOT** hold the float up for an extended time without water in the sump. While the pumps are active, water will come out of the 1/8" holes located on the top of the main pump and in the elbow of the backup pump. This is normal. The holes are needed to prevent an air lock within the system. **DO NOT** obstruct the holes or an air lock may prevent the system from activating.



### Using the Remote Notification

#### THE REMOTE TERMINAL

The BW4000 can be connected to a home security system or other alarm devices to alert you to a problem or required maintenance.

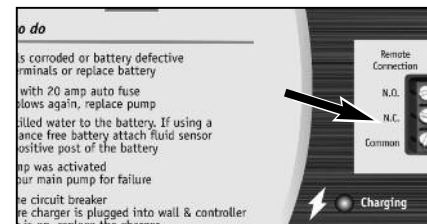

### INSTRUCTIONS FOR CONNECTING THE REMOTE ALARM

The terminal is located on the front of the control unit. There are three (3) positions for wire connections on the terminal: N.O. - normally open, N.C. - normally closed, and common.

Check your security system to determine whether an open (no contact) or closed (making contact) connection is needed to activate the alarm.

The security system will provide two connection terminals. You will need to extend wires from the security system to the Basement Watchdog control unit. Strip the two wires, 1/4" each. Connect either wire to the common terminal. To secure the wire into the terminal, insert the exposed wire into the hole on the back of the terminal next to the screw marked common. Turn the screw a few turns to lock-in the wire.

If the security system requires a closing of a contact to activate the alarm, secure the other wire in the terminal hole labeled N.O. (normally open). If the security system requires an opening of a contact, secure the wire in the terminal hole labeled N.C. (normally closed).

### USB DATA PORT

This system has been updated with a USB port on the side of the controller. The purpose of this port is to allow communication with the Basement Watchdog CONNECT® Modules.

**DO NOT** connect any other device to the USB data port other than a Basement Watchdog Wifi or Home Automation Connect Module.



### CONNECT MODULES

The Basement Watchdog CONNECT® Modules are separately sold accessories that will allow the user to stay connected and receive remote notifications of potential problems and needed maintenance while away



from home. There are currently two modules that can be connected:

### Basement Watchdog WiFi Module

(Model No. BW-WiFi)

- Sends emails or text notifications and status alerts to your phone, tablet or computer
- No required monthly or yearly fees or subscriptions

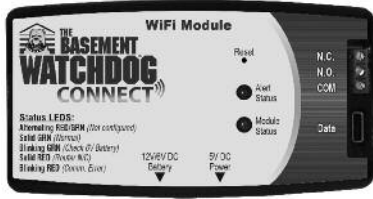

Model No. BW-WiFi

### Basement Watchdog Home Automation Module

(Model No. BW-HZM)

- Easily connects to compatible monitored security or home automation system
- Connects using Z-Wave Plus



Model No. BW-HZM

For more information, please visit [www.BasementWatchdog.com](http://www.BasementWatchdog.com)

## MAINTENANCE CHECK LIST

Maintenance should be performed 1-2 times per year

1. Lift the float switch as described at left.
2. Remove all debris from the bottom of the pit and pump strainers.
3. Remove all debris from the water.
4. Remove all debris from the float switch.
5. Fill the pit with water. Make sure the pump turns on at the intended level.
6. While the pump is running, make sure the pump is evacuating water at a good pace and water is coming out of the 1/8" air bleed hole.
7. Remove the fluid sensor and yellow cap from the battery and rinse any residue buildup from the bottom of the battery cap. Replace the cap and fluid sensor.
8. Check battery fluid levels once every four months.

## PARTS & SERVICE INFORMATION

You can receive technical support, parts or service information by calling Glentronics, Inc. at 800-991-0466, option 3, or by visiting the website at [www.basementwatchdog.com](http://www.basementwatchdog.com). Send your unit to the following address for repairs:

Glentronics, Inc.  
645 Heathrow Drive, Lincolnshire, IL 60069

## Replacement Parts List

Description	Part No.	Description	Part No.
1/2 HP AC sump pump	BW1050-GL	Backup pump locking screw (#12 x 1/2" pan head)*	1100018
Caged dual float switch with piggyback controller	BWC2	1-1/4" check valve for backup pump*	1141000
Backup pump	1011002	1-1/2" check valve for primary pump*	1141001
Backup control unit	BWSP-A	No-hub stainless steel connectors*	1142000
"Y" PVC pipe fitting	1120007	1-1/2" rubber union*	1142001
Support bracket for backup pump	1121006	2" hose clamp*	1122002
Battery cap with hole for the fluid sensor	1125000	Cable tie*	1122000
Charger for backup pump	1015001		
Backup dual float switch	1020009		

\*Stock items available in plumbing department

Call 800-991-0466, option 3 to order parts.

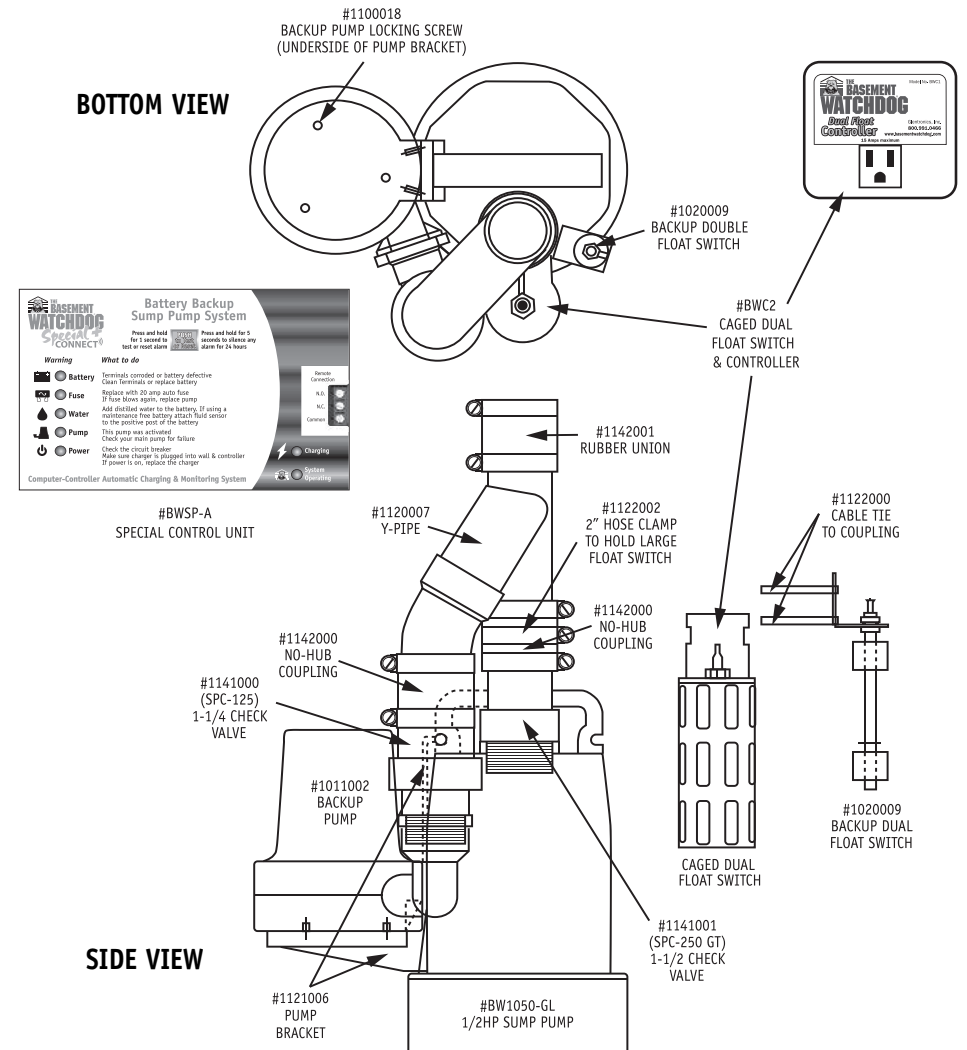

## Primary Pump Troubleshooting Guide

### **⚠ DANGER**

Read safety warnings & instructions before attempting any repairs or maintenance.

Potential Cause	THE PUMP WILL NOT START OR RUN	Solutions
Pump is not plugged in	Plug pump in properly (see instructions)	
No AC power	Check circuit breaker or fuse	
Poor power source	Check circuit line wires, cable and outlet	
Locked impeller	Remove strainer and clear obstruction	
Defective float switch	Replace float switch with new float switch	
Defective pump	Replace pump with new pump	
Potential Cause	THERMAL PROTECTOR TRIPPING OR NOT FUNCTIONING	Solutions
Locked impeller	Remove strainer and clear obstruction	
Incorrect power supply	Check power supply source and voltage	
Pump running continuously with no water present	Check float switch	
Potential Cause	PUMP STARTS AND STOPS TOO FREQUENTLY	Solutions
Float switches mounted too low	Raise both float switches	
Water back flowing from pipe	Install or replace check valve	
Malfunctioning float switch	Replace float switch with new float switch	
Potential Cause	PUMP WILL NOT SHUT OFF	Solutions
Clogged or frozen discharge	Clear blockage or thaw frozen line	
Blocked intake strainer	Clear debris from intake strainer	
One or both of the floats is obstructed and cannot drop down	Clear debris from inside the float cage (Loosen nut on top of float, then remove c-clip on bottom of float. Remove debris. Tighten nut on top of float, then replace c-clip on bottom of float.) When reassembling the float, the magnetic strip on the inside of the float should be facing down.	
Defective float switch	Replace float switch with new float switch	
Check valve is stuck	Replace check valve.	
Potential Cause	INSUFFICIENT OR NO WATER VOLUME	Solutions
Check valve on secondary pump will not close and water re-circulates within the system	Replace the check valve on the secondary pump	
Partially blocked impeller	Remove strainer and clear obstruction	
Clogged or frozen discharge pipe	Clear blockage or thaw frozen line	
Broken or leaking pipe	Repair pipe	
Low power voltage	Check power voltage, wires and cable condition	
Check valve is stuck	Replace check valve	
There is an air lock within the system	Make sure the air relief valve located on the top of the primary pump is clear of debris	
Potential Cause	ABNORMAL SOUND OR VIBRATION	Solutions
Check valve is broken	Replace the check valve	
Blocked intake screen	Clear debris from intake screen	
Defective pump	Replace pump	

If the above solutions do not resolve the problem, follow the instructions within this manual to disconnect the system from the outlet and battery terminals, then reconnect the system and push the reset button. If the problem continues, contact customer service.

## Backup Pump Troubleshooting Guide

### **⚠ DANGER**

Read safety warnings & instructions before attempting any repairs or maintenance.

Potential Cause	BATTERY FLUID LOW	Solutions
The battery fluid is low	Add distilled water to each cell of the battery	
The fluid sensor is installed improperly	The fluid sensor should be inserted into the designated hole on the top of the battery and pushed down	
Not using a Basement Watchdog battery	This feature cannot be used. Attach the fluid sensor to the positive post of the battery	
Potential Cause	BATTERY PROBLEM	Solutions
Terminals are corroded	Clean terminals and cables	
Cables are loose	Tighten wing nuts	
Battery is discharged below 25%	Replace battery if power is out. There is only 1/2 hour of continuous pumping power left. Battery will recharge when power is restored	
Battery is old or damaged	Replace battery	
Potential Cause	POWER FAILURE	Solutions
Power outage	None. To silence the alarm for 24 hours, press and hold the yellow button on the front panel of the backup controller for 5 seconds	
An outlet, fuse, or circuit breaker has failed	Try another outlet, replace the fuse, or reset the circuit breaker	
The charger is unplugged from the wall or the back of the controller	Make sure the power cord is plugged in securely	
The control unit is receiving less than 110 volts from the outlet	None, if the utility company has instigated brown outs. Otherwise, reduce the number of other appliances on the circuit	
Potential Cause	PUMP WILL NOT SHUT OFF	Solutions
Backup pump is clogged	Remove strainer from pump and clean out any debris	
Backup pump is broken	Replace the pump	
There is a slight chance of false activation if the float switch cord is wrapped around the AC power cord	Move the float switch cord away from the AC power cord	
Potential Cause	INSUFFICIENT OR NO WATER VOLUME	Solutions
Backup pump is unplugged	Make sure the pump is securely plugged into the back of the control unit	
The main AC pump failed because of a power outage	None. The backup pump was activated when needed	
The water was coming into the sump faster than the main pump could evacuate it	None. The backup pump was activated when needed	
The float switch on the main AC pump is stuck or defective	Free the float switch on the main pump or replace it	
The main AC pump is broken	Replace the main AC pump	
The main AC pump could not keep up with the inflow of water	None. The backup pump was activated as needed	
The check valve is stuck and the water cannot pass through it	Replace the check valve	
The discharge pipe is clogged or frozen and the water cannot pass through it	Thaw, cleanout the blockage, or replace the discharge pipe	
There is an air lock within the system	Make sure the 1/8" weep hole is drilled in the elbow of the backup pump. Make sure it is clear of debris	
Potential Cause	ABNORMAL SOUND OR VIBRATION	Solutions
Check valve is broken	Make sure check valve is functioning, or replace it	
Discharge pipe is clogged or frozen	Clear the discharge pipe	

## Limited Warranty

By opening this package and using this GLETRONICS, INC. product, you are agreeing to be bound by the terms of the GLETRONICS, INC. limited warranty ("warranty") as set out below. Do not use your product until you have read the terms of the warranty. If you do not agree to the terms of the warranty, do not use the product and return it within the return period stated on your purchase receipt from the retail store or authorized distributor where you purchased it for a refund.

To the extent permitted by law, this warranty and the remedies set forth are exclusive and in lieu of all other warranties, remedies and conditions, whether oral, written, statutory, express or implied. GLETRONICS, INC. disclaims all statutory and implied warranties, including without limitation, warranties of merchantability and fitness for a particular purpose and warranties against hidden or latent defects, to the extent permitted by law. GLETRONICS, INC. will not be liable for any incidental, special or consequential damages for breach of any express or implied warranties on this product. In so far as such warranties cannot be disclaimed, GLETRONICS, INC. limits the duration and remedies of such warranties to the duration of this express warranty and, AT GLETRONICS, INC.'s option, the repair or replacement services described below. Some states (countries and provinces) do not allow limitations on how long an implied warranty (or condition) may last, so the limitation described above may not apply to you.

Any and all causes of action arising from, filed as a result of or in reference to, this warranty or the products described under this warranty shall be governed by and construed under the laws of the State of Illinois. Any cause of action arising from, filed as a result of or in reference to, this warranty or the products described under this warranty shall be filed only in the Circuit Court of the 18th Judicial District, Lake County, Waukegan, Illinois, or in the Northern District of Illinois if filed in Federal Court. The maximum liability for any product described in this warranty shall be the cost of product replacement only.

If any term is held to be illegal or unenforceable, the legality or enforceability of the remaining terms shall not be affected or impaired.

### What is Covered by this Warranty?

GLETRONICS, INC. warrants to the end purchaser that its pumps, switch and control unit products are free from defective materials and workmanship for the periods indicated below:

All parts and labor (excluding installation) for a period of:

- 2 years from the date of purchase, when used intermittently as a sump pump

The defective product must be returned directly to the factory, postage prepaid with the original bill of sale or receipt to the address listed below. GLETRONICS, INC., at its option, will either repair or replace the product and return it postage prepaid.

### What is NOT Covered by this Warranty?

This warranty does not cover the cost or value of damaged property, including expressly any property that has been affected by water overflow, seepage or flooding. If GLETRONICS, INC. determines that a product is deemed defective under this warranty agreement, it will repair or replace the PRODUCT ONLY. GLETRONICS, INC. will not cover the cost to reinstall the product, nor will GLETRONICS, INC. pay the cost of having a plumber or contractor repair or replace the product.

GLETRONICS, INC. will not repair or replace a product that was installed incorrectly. A product shall be considered "installed incorrectly" when it deviates in any way from the instructions described in this manual.

This warranty does not cover product problems resulting from handling liquids hotter than 104 degrees Fahrenheit, handling inflammable liquids, solvents, strong chemicals or severe abrasive solutions; user abuse; misuse, neglect, improper maintenance, commercial or industrial use; improper connection or installation, damages caused by lightning strikes; excessive surges in AC line voltage; water damage to the controller; other acts of nature, or failure to operate in accordance with the enclosed written instructions.

### How to Obtain Warranty Service

Within thirty (30) days of the product's defective performance, the unit must be shipped, freight prepaid, or delivered to GLETRONICS, INC. to provide the services described hereunder in either its original carton and inserts, or a similar package affording an equal degree of protection. Products not received by GLETRONICS, INC. at the address indicated below within thirty (30) days of the product's defective performance will not be considered for warranty service. Products received after two (2) years from the date of purchase, fall outside of the timeframe for warranty service and will not be eligible for warranty service. The product must be returned to GLETRONICS, INC. for inspection in order to be considered for warranty service. If the product is not returned to GLETRONICS, INC. or the product is inspected by any person, plumber, contractor or business other than GLETRONICS, INC., this warranty shall no longer be valid. Prior to defective operation, the unit must not have been previously altered, repaired or serviced by anyone other than GLETRONICS, INC., or its agent; the serial number on the unit must not have been altered or removed; the unit must not have been subject to accident, misuse, abuse or operated contrary to the instructions contained in the accompanying manual. The dealer's dated bill of sale, or installer's invoice must be retained as evidence of the date of purchase and to establish warranty eligibility.

### Where are Products Sent for Warranty Service?

Glentronics, Inc., 645 Heathrow Drive, Lincolnshire, IL 60069

### How Can I Obtain More Information?

By calling 800-991-0466.