

FRIGIDAIRE

All about the

Use & Care

of your Electric Range



TABLE OF CONTENTS

Product Record and Registration	2	Care and Cleaning	33
Important Safety Instructions	3	Before You Call	38
Before Setting Surface Controls	9	Warranty	44
Setting Surface Controls	12		
Before Setting Oven Controls	15		
Oven Controls	16		

808576301 Rev B (December 2016)

PRODUCT RECORD AND REGISTRATION

Product Record and Registration	2
Important Safety Instructions	3
Before Setting Surface Controls	9
Setting Surface Controls	12
Before Setting Oven Controls	15
Oven Controls	16
Care and Cleaning	33
Before You Call	38
Warranty	44

Thank you for choosing **Frigidaire**.

This Use and Care Guide is part of our commitment to customer satisfaction and product quality throughout the service life of your new appliance. We view your purchase as the beginning of a relationship. To ensure our ability to continue serving you, please use this page to record important product information.

Need Help?

Visit the Frigidaire web site at www.frigidaire.com

Before you call for service, there are a few things you can do to help us serve you better.

Read this Use & Care Manual

This manual contains instructions to help you use and maintain your range properly.

If You Received a Damaged Range...

Immediately contact the dealer (or builder) that sold you the range.

Questions?

For toll-free telephone support in the U.S. and Canada call **1-800-944-9044**

For online support and Internet production information visit www.frigidaire.com.

Save Time and Money

Check the section title "Before You Call". This section helps step you through some common problems that might occur.

If you do need service, help is only a phone call away. Call Frigidaire Customer Services at **1-800-944-9044**.

Product Registration

Registering your product with Frigidaire enhances our ability to serve you. Register online at www.frigidaire.com or by dropping your Product Registration Card in the mail.

Serial Plate Location:

The serial plate is located on top of the range's lower front panel, and can be clearly viewed when door is open.

Record model & serial numbers here

Purchase Date

Frigidaire model number

Frigidaire serial plate number



Fig. 1 Model, serial number location

IMPORTANT SAFETY INSTRUCTIONS

Read all instructions before using this appliance.

This manual contains important safety symbols and instructions. Please pay attention to these symbols and follow all instructions given.

Do not attempt to install or operate your appliance until you have read the safety precautions in this manual. Safety items throughout this manual are labeled with a **WARNING** or **CAUTION** statement based on the risk type.

Warnings and important instructions appearing in this guide are not meant to cover all possible conditions and situations that may occur. Common sense, caution, and care must be exercised with installing, maintaining, or operating your appliance.

DEFINITIONS

 This is the safety alert symbol. It is used to alert you to potential personal injury hazards. Obey all safety messages that follow this symbol to avoid possible injury or death.

WARNING

Indicates a potentially hazardous situation which, if not avoided, may result in death or serious injury.

CAUTION

Indicates a potentially hazardous situation which, if not avoided, may result in minor or moderate injury.

IMPORTANT

Indicates installation, operation, maintenance, or valuable information that is not hazard related.

NOTE

Indicates a short, informal reference-something written down to assist the memory or for future reference.

WARNING

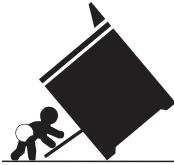

Tip Over Hazard

- A child or adult can tip the range and be killed.
- Verify the anti-tip device has been installed to floor or wall.
- Ensure the anti-tip device is re-engaged to floor or wall when the range is moved.
- Do not operate the range without the anti-tip device in place and engaged.
- Failure to follow these instructions can result in death or serious burns to children and adults.

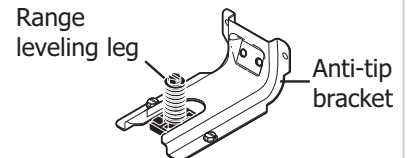

To check if the anti-tip bracket is installed properly, use both arms to grasp the rear edge of the range back. Carefully attempt to tilt range forward. When properly installed, the range should not tilt forward.

Refer to the anti-tip bracket installation instructions supplied with your range for proper installation.

IMPORTANT SAFETY INSTRUCTIONS

IMPORTANT INSTRUCTIONS FOR UNPACKING AND INSTALLATION

IMPORTANT

Read and follow the below instructions and precautions for unpacking, installing, and servicing your appliance:

- Remove all tape and packaging before using the appliance. Destroy the carton and plastic bags after unpacking the appliance. Never allow children to play with packaging material. Do not remove the wiring label and other literature attached to the range. Do not remove model/serial number plate.
- Cold temperatures can damage the electronic control. When using this appliance for the first time, or when the appliance has not been used for an extended period of time, be sure the appliance has been in temperatures above 32°F (0°C) for at least 3 hours before turning on the power to the appliance.
- Never modify or alter the construction of the appliance by removing the leveling legs, panels, wire covers, anti-tip brackets/screws, or any other part of the appliance.
- Be sure to have an appropriate foam-type fire extinguisher available, visible, and easily accessible located near the appliance.

GROUNDING INSTRUCTIONS

WARNING

Avoid fire hazard or electrical shock. Failure to follow this warning may cause serious injury, fire, or death.

WARNING

Avoid fire hazard or electrical shock. Do not use an adapter plug, use an extension cord, or remove grounding prong from the power cord. Failure to follow this warning may cause serious injury, fire, or death.

Proper Installation—Be sure your appliance is properly installed and grounded by a qualified technician. In the United States, install in accordance with the National Fuel Gas Code ANSI Z223.1/NPFA No. 54, latest edition and National Electrical Code NFPA No. 70 latest edition, and local electrical code requirements. In Canada, install in accordance with CAN/CGA B149.1 and CAN/CGA B149.2 and CSA Standard C22.1, Canadian Electrical code, Part 1-latest editions and local electrical code requirements. Install only per installation instructions provided in the literature package for this appliance.

For personal safety, this appliance must be properly grounded. For maximum safety, the power cord must be securely connected to an electrical outlet or junction box that is the correct voltage, is correctly polarized and properly grounded, and protected by a circuit breaker in accordance with local codes.

It is the personal responsibility of the consumer to have the appropriate outlet or junction box with the correct, properly grounded wall receptacle installed by a qualified electrician. It is the responsibility and obligation of the consumer to contact a qualified installer to assure that the electrical installation is adequate and is in conformance with all local codes and ordinances.

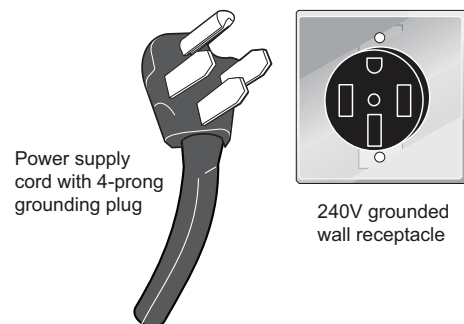

This appliance is equipped with a 4-prong grounding plug for your protection against shock hazard and should be plugged directly into a properly grounded receptacle. Do not cut or remove the grounding prong from this plug.

See the installation instructions packaged with this appliance for complete installation and grounding instructions.

IMPORTANT SAFETY INSTRUCTIONS

IMPORTANT INSTRUCTIONS FOR USING THE APPLIANCE

WARNING

- Storage In or On Appliance—Flammable materials should not be stored in an oven, near surface elements, or in the warmer drawer (if equipped). This includes paper, plastic, and cloth items, such as cookbooks, plastic ware, and towels, as well as flammable liquids. Do not store explosives, such as aerosol cans, on or near the range.
- **Do not leave children alone** - Children should not be left alone or unattended in the area where the appliance is in use. They should never be allowed to sit or stand on any part of the appliance, including the storage drawer, lower broiler drawer, or lower double oven.
- Do not store items of interest to children in the cabinets above the range. Children climbing on the range to reach items could be seriously injured.
- Do not allow children to climb or play around the appliance. The weight of a child on an open oven door may cause the appliance to tip, resulting in serious burns or other injury. An open drawer when hot may cause burns.
- Do not store items of interest to children in the cabinets above the range. Children climbing on the range to reach items could be seriously injured.
- Stepping, leaning, or sitting on the door or drawers of this appliance can result in serious injuries and also cause damage to the appliance.

WARNING

- Never cover any slots, holes, or passages in the oven bottom or cover an entire oven rack with materials such as aluminum foil or after-market oven liners. Aluminum foil linings may trap heat, causing a fire hazard.
- Do not use oven or warmer drawer (if equipped) for storage.
- Never use your appliance as a space heater to heat or warm the room. Doing so may result in carbon monoxide poisoning and overheating of the appliance.

CAUTION

- When heating fat or grease, watch it closely. Grease may catch fire if it becomes too hot.
- Do not use water or flour on grease fires. Smother fire or flame or use dry chemical or foam-type extinguisher. Cover the fire with a pan lid or use baking soda.
- Use dry potholders. Moist or damp potholders on hot surfaces may result in burns from steam. Do not let potholders touch hot cooking areas. Do not use towels or other bulky cloths.
- Do not heat unopened food containers - Build-up of pressure may cause container to burst and result in injury.
- Wear proper apparel - Loose-fitting or hanging garments should never be worn while using the appliance. Do not let clothing or other flammable materials contact hot surfaces.

IMPORTANT SAFETY INSTRUCTIONS

CAUTION

- Do not touch surface elements or elements, areas near these burners or elements, interior surfaces of the oven, or the warmer drawer (if equipped). Surface burners and elements may be hot even though they appear cool. Areas near surface burners and elements may become hot enough to cause burns. During and after use, do not touch, or let clothing or other flammable materials touch these areas until they are cool. These areas may include the cooktop, surfaces facing the cooktop, oven vent areas, oven door, and oven window.
- Do not attempt to operate the appliance during a power failure. If the power fails, always turn off the appliance. If the appliance is not turned off and the power resumes, electric surface elements may resume operation when power is restored. Once the power resumes, reset the clock and the oven function.

IMPORTANT INSTRUCTIONS FOR USING YOUR RADIANT COOKTOP

- Know which knob or key controls each surface heating area. Place cookware with food on the cooking area before turning it on. Turn the cooking area off before removing the cookware.
- Cookware handles should be turned inward and not extend over adjacent surface elements — To reduce the risk of burns, ignition of flammable materials, and spillage due to unintentional contact with the utensil, the handle of the cookware should be positioned so that it is turned inward, and does not extend over other cooking areas.

- Use proper pan size - This appliance is equipped with one or more surface units of different sizes. Select cookware with flat bottoms that match the surface unit size. Using the proper cookware on the cooking area will improve efficiency.
- Glazed cooking utensils— Only certain types of glass, glass/ceramic, ceramic, earthenware, or other glazed utensils are suitable for cooktop service without breaking due to the sudden change in temperature. Check the manufacturer's recommendations for cooktop use.
- Improper cookware may break due to sudden changes in temperature. Check the cookware manufacturer's recommendations for cooktop use.
- Never leave surface elements unattended. Boil-overs may cause smoking and greasy spills that may ignite. A pan that has boiled dry could be damaged and may damage the cooktop.
- Do not use a searing grill meant for use with a broiler pan on the cooktop. The searing grill is not designed for use on the cooktop. Doing so may result in a fire.
- When you are flaming foods under a ventilating hood, turn on the fan.

IMPORTANT INSTRUCTIONS FOR GLASS AND CERAMIC COOKTOPS

- Do Not Clean or Operate a Broken Cooktop. If cooktop should break, cleaning solutions and spillovers may penetrate the broken cooktop and create a risk of electric shock. Contact a qualified technician immediately.
- Clean cooktop glass with caution. If a wet sponge or cloth is used to wipe spills on a hot cooking area, be careful to avoid a steam burn. Some cleaners can produce harmful fumes if applied to a hot surface.
- Avoid scratching the cooktop glass with sharp objects.

IMPORTANT SAFETY INSTRUCTIONS

IMPORTANT INSTRUCTIONS FOR USING YOUR OVEN

- Protective liners—Do not use aluminum foil, aftermarket oven liners, or any other materials or devices to line oven bottom, oven racks, or any other part of the appliance. Only use aluminum as recommended for baking, such as lining cookware or as a cover placed on food. Any other use of protective liners or aluminum foil may result in a risk of electric shock or fire or a short circuit.
- Use care when opening oven door, lower oven door, or warmer drawer (some models). Stand to the side of the appliance when opening the door of a hot oven. Let hot air or steam escape before you remove or replace food in the oven.
- Keep oven vent ducts unobstructed. Touching surfaces in this area when the oven is on may cause severe burns. Do not place plastic or heat-sensitive items on or near the oven vent. These items can melt or ignite.
- Placement of oven racks - Always place oven racks in desired location while oven is cool. If rack must be moved while oven is hot, do not let potholder contact hot burner or element in oven. Use potholders and grasp the rack with both hands to reposition. Remove all cookware and utensils before moving the rack.
- Do not use a broiler pan without its insert. Broiler pans and inserts allow dripping fat to drain away from the high heat of the broiler. Do not cover the broiler insert with aluminum foil; exposed fat and grease could ignite.
- Do not cook food on the oven bottom. Always cook in proper cookware and always use the oven racks.

IMPORTANT INSTRUCTIONS FOR CLEANING YOUR APPLIANCE

CAUTION

Before manually cleaning any part of the appliance, be sure all controls are turned off and the range is cool. Cleaning a hot oven can cause burns.

- Clean the appliance regularly to keep all parts free of grease that could catch fire. Do not allow grease to accumulate. Greasy deposits in the fan could catch fire.
- Always follow the manufacturer's recommended directions for use of kitchen cleaners and aerosols. Be aware that excess residue from cleaners and aerosols may ignite causing damage and injury.
- Clean ventilating hoods frequently - Grease should not be allowed to accumulate on the hood or filter. Follow the manufacturer's instructions for cleaning vent hoods.

IMPORTANT SAFETY INSTRUCTIONS

IMPORTANT INSTRUCTIONS FOR SELF CLEANING OVENS

- Do not clean the oven door gasket. The door gasket is essential for a good seal. Care should be taken not to rub, damage, or move the gasket.
- Do not use oven cleaners. No commercial oven cleaner or oven liner protective coating of any kind should be used in or around any part of the appliance.
- Use the self clean cycle to clean only the parts listed in this manual.
- Before using self clean, remove the broiler pan, any food, utensils, and cookware from the oven, storage drawer or warming drawer (if equipped). Remove oven racks unless otherwise instructed.
- Some birds are extremely sensitive to the fumes given off during the self clean cycle of any oven. Move birds to another well-ventilated room.

IMPORTANT INSTRUCTIONS FOR SERVICE AND MAINTENANCE

- Do not repair or replace any part of the appliance unless specifically recommended in the manuals. All other servicing should be done only by a qualified technician. This reduces the risk of personal injury and damage to the appliance.
- Always contact your dealer, distributor, service agent, or manufacturer about problems or conditions you do not understand.
- Ask your dealer to recommend a qualified technician and an authorized repair service. Know how to disconnect the power to the appliance at the circuit breaker or fuse box in case of an emergency.
- Remove the oven door from any unused oven if it is to be stored or discarded.
- Do not touch a hot oven light bulb with a damp cloth. Doing so could cause the bulb to break. Handle halogen lights (if equipped) with paper towels or soft gloves. Disconnect the appliance or shut off the power to the appliance before removing and replacing the bulb.

IMPORTANT

- Important Safety Notice - The California Safe Drinking Water and Toxic Enforcement Act requires the governor of California to publish a list of substances known to cause cancer, birth defects, or other reproductive harms, and requires businesses to warn customers of potential exposures to such substances.

BEFORE SETTING SURFACE CONTROLS

Using Proper Cookware

The size and type of cookware used will influence the radiant element power level setting needed for best cooking results. Be sure to follow the recommendations for using proper cookware as illustrated in [Figure 2](#) and [Figure 3](#).



Figure 2: Testing cookware

Check for flatness by rotating a ruler across the bottom of the cookware (See [Figure 2](#)). Cookware should have flat bottoms that make good contact with the entire surface heating element (See [Figure 3](#)). For detailed information about the ceramic cooktop, refer to “[Cooktop Maintenance](#)” on [page 35](#).

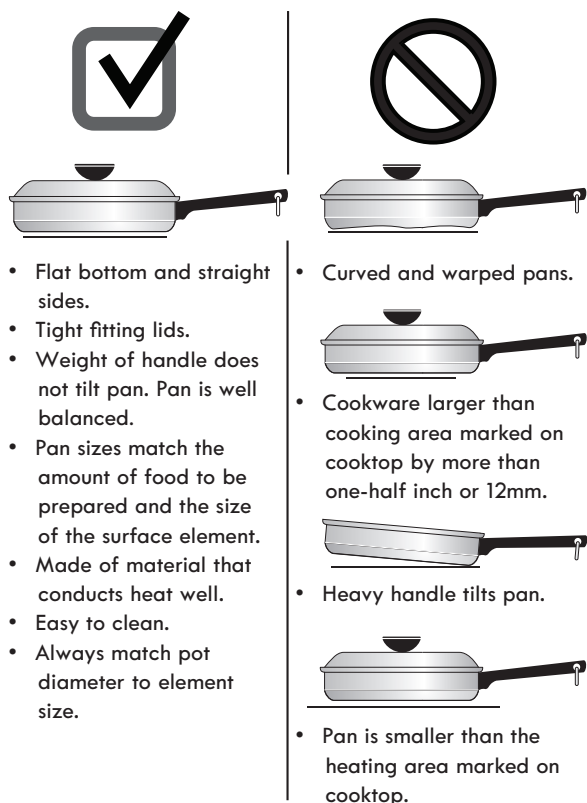

Figure 3: Proper cookware

Cookware Material Types

The cookware material determines how evenly and quickly heat is transferred from the surface element to the pan bottom. The most popular materials available are:

- Aluminum - Excellent heat conductor. Some types of food will cause it to darken (Anodized aluminum cookware resists staining and pitting). If aluminum pans slide across the ceramic cooktop, they may leave metal marks which will resemble scratches. Remove these marks immediately.
- Copper - Excellent heat conductor but discolors easily (See Aluminum).
- Stainless - Slow heat conductor with uneven cooking results. Is durable, easy to clean and resists staining.
- Cast Iron - A slow heat conductor however will retain heat very well. Cooks evenly once cooking temperature is reached. Not recommended for use on ceramic cooktops.
- Porcelain-enamel on metal - Heating characteristics will vary depending on base material. Porcelain-enamel coating must be smooth to avoid scratching ceramic cooktops.
- Glass - Slow heat conductor. Not recommended for ceramic cooktop surfaces because it may scratch the glass.

▶ IMPORTANT

Do not place empty aluminum, glass or porcelain-enamel coated cookware on the ceramic cooktop! The melting point of cookware made with these materials may be reached quickly especially if left empty, and they may bond to the ceramic cooktop. If the cookware melts it will damage the cooktop. Be sure to follow all the cookware manufacturer's suggestions when using any type of cookware on the ceramic cooktop.

BEFORE SETTING SURFACE CONTROLS

About the Ceramic Glass Cooktop

The ceramic cooktop has radiant surface elements located below the surface of the glass. The design of the ceramic cooktop outlines the area of the surface element underneath. Be sure to match the pan size with the diameter of the element outline on the cooktop and only flat-bottomed cookware should be used.

The type and size of cookware, the number of surface elements in use and their settings are all factors that will affect the amount of heat that will spread to areas beyond the surface elements. The areas surrounding the elements may become hot enough to cause burns.

▶ IMPORTANT

- The cooktop should not be used as a cutting board or work surface. Dropping heavy or hard objects on the cooktop may crack it.
- Pans with rough bottoms may scratch the cooktop surface. Placing food directly on the smoothtop surface (without cooking utensil) is not recommended as difficult cleaning will result and foods may smoke and cause potential fire hazard.
- Always lift cookware before moving on ceramic glass cooktop. Any cookware that has rough or dirty bottoms can scratch the ceramic cooktop. Always start with clean cookware.

About the Radiant Surface Elements

The element temperature rises gradually and evenly. As the temperature rises, the element will glow red. To maintain the selected setting the element will cycle on and off. The heating element retains enough heat to provide a uniform and consistent heat during the off cycle.

For efficient cooking, turn off the element several minutes before cooking is complete. This will allow residual heat to complete the cooking process.

⚠ CAUTION

Do not allow aluminum foil, or any material that can melt, to make contact with the ceramic glass cooktop. If these items melt on the cooktop, they will damage the ceramic cooktop.

Radiant elements may be hot after they appear to have cooled but the glass surface may still be hot and burns may occur if the glass surface is touched before the indicator light has turned off.

📌 NOTE

Radiant elements have a limiter that allows the element to cycle on and off, even at the HI setting. This helps to prevent damage to the ceramic smooth top. Cycling at the HI setting is normal and can occur if the cookware is too small for the radiant element or if the cookware bottom is not flat.

Be sure to read detailed instructions for ceramic glass cooktop cleaning in the General Care & Cleaning section and Before You Call checklist section of this Use and Care Guide.

📌 NOTE

- The element on and hot surface indicator lights will glow when the element is turned on and will continue to glow after the control knob is turned to the OFF position. It will glow until the heating surface area has cooled sufficiently.

Element On and Hot Surface Indicator Lights

When an element is turned on the ELEMENT ON indicator light will glow. The HOT SURFACE indicator light will turn on when the element is hot enough to cause burns and will remain on until the surface has cooled to a safe temperature after the element is turned off. The ELEMENT ON indicator light will glow when one or more elements are turned on. A quick glance at these indicator lights when cooking is finished is an easy check to be sure all surface elements are turned off.

Element On Hot Surface



Figure 4: The Element On indicator glows when any element is on. The Hot Surface indicator light is on as long as the surface is hot enough to cause burns.

BEFORE SETTING SURFACE CONTROLS

Home Canning

CAUTION

Canning can generate large amounts of steam. Use extreme caution to prevent burns. Always raise the lid to vent steam away from you. Safe canning requires that harmful micro-organisms are destroyed and the jars are sealed completely. When canning in a water bath canner, a gentle but steady boil must be maintained continuously for the required time.

Be sure to read and observe all the following points when home canning with your appliance. Check with the USDA (United States Department of Agriculture) Web site and be sure to read all the information they have available as well as follow their recommendations for home canning procedures.

Home Canning Do's and Don'ts

- Use only quality flat bottom canners when home canning.
- Use a straight-edge to check canner bottom.
- Use only a completely flat bottom canner with no ridges that radiate from the bottom center when home canning. Heat is spread more evenly when the bottom surface is flat.
- Make sure the diameter of the canner does not exceed 1 inch beyond the surface element markings.
- It is recommended to use smaller diameter canners on ceramic glass cooktops and to center canners on the element.
- Start with hot tap water to bring water to boil more quickly.
- Use the highest heat setting when first bringing the water to a boil. Once boiling is achieved, reduce heat to lowest possible setting to maintain that boil.
- Use tested recipes and follow instructions carefully. Check with your local Cooperative Agricultural Extension Service or a manufacturer of glass jars for the latest canning information.
- It is best to can small amounts and light loads.
- Do not leave water bath or pressure canners on high heat for an extended amount of time.
- Alternate surface units between each batch to allow the units and surrounding surfaces to cool down. Try to avoid canning on the same element unit all day.

SETTING SURFACE CONTROLS

Surface Control Settings

The size and type of cookware used, and the amount and type of food being cooked will influence the surface element power level setting needed for best cooking results. Once an element is heating it will cycle on and off to maintain the heat setting. The element on indicator light will glow once a element is turned on.

Use [Table 1](#) to determine the correct setting for the type of food you are preparing.



Figure 5: Cooktop showing bridge element (L) and triple element right front. Warmer zone middle (rear).

CAUTION

Radiant surface elements may appear to have cooled after they have been turned off. The hot surface light will turn on and will continue to glow until the glass cooktop has cooled down to a moderate level.

The glass surface may still be hot and burns may occur if the glass surface is touched before the hot surface indicator light has turned off.

IMPORTANT

- Start most cooking operations on a higher setting and then turn to a lower setting to finish cooking. A glowing red surface heating area extending beyond the bottom edge of the cookware indicates the cookware is too small for the surface heating area.
- Never straddle cookware between two surfaces unless designed for that purpose.

NOTE

The size and type of cookware used will influence the setting needed for best cooking results.

Table 1: Recommended settings for surface elements

Setting	Type of Cooking
HIGH (HI)	Start most foods; bring water to a boil and pan broiling.
MEDIUM HIGH (8-10)	Continue a rapid boil; frying, deep fat frying
MEDIUM (6)	Maintain a slow boil; thicken sauces and gravies; steaming vegetables
MEDIUMLOW (2-4)	Keep foods cooking; poaching and stewing
LOW (LO)	Keep warm, melting and simmering

CAUTION

Do not place plastic items such as salt and pepper shakers, spoon holders or plastic wrappings on top of the range when it is in use. These items could melt or ignite. Potholders, towels or wooden spoons could catch fire if placed too close to the surface elements.

Do not allow aluminum foil, empty glass/porcelain cookware or any material that can melt to make contact with the ceramic cooktop. If these items melt on the cooktop they may damage the ceramic cooktop.

NOTE

The surface control knobs do not have to be set exactly on a particular spot. Use the graphics provided as a guide and adjust the control knob as needed.

Each surface element provides a constant amount of heat at each setting. Refer to [Table 1](#) for suggested settings.

SETTING SURFACE CONTROLS

Single Radiant Element

The cooktop has three single radiant surface elements: the left rear and left front elements, and the right rear element. The left front element may also be used with the bridge element. The triple element also has a single element setting for smaller cookware.

To operate a single element:

1. Place correctly sized cookware on the surface element.
2. Push in and turn the surface control knob in either direction to the desired setting (See [Figure 6](#)). Start most cooking operations on a higher setting and then turn to a lower setting to finish cooking. Each surface element provides a constant amount of heat at each setting. A glowing red surface heating area extending beyond the bottom edge of the cookware indicates the cookware is too small for the surface heating area.
3. When cooking has completed, turn the surface control knob to **OFF** before removing the cookware.

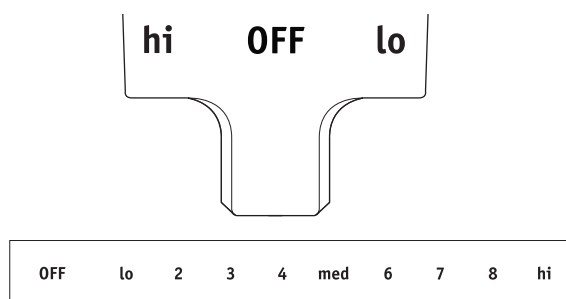

Figure 6: Control knob single surface element

CAUTION

Radiant surface elements may appear to have cooled after they have been turned off. The hot surface indicator light will turn on and will continue to glow until the glass cooktop has cooled down to a moderate level. The glass surface may still be hot and burns may occur if the glass surface is touched before the indicator light has turned off. The message may remain on even though the controls are turned off.

Triple Surface (expandable) Element (some models)

The expandable element can accommodate 6 inch, 9 inch, or 12 inch cookware. The triple element is especially useful for canning or heating large amounts of water.

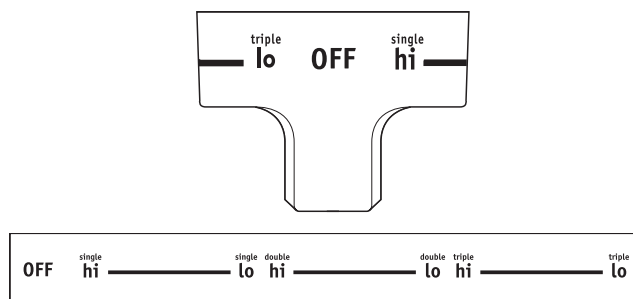

Figure 7: Triple element control

To operate the triple surface element:

1. Place correctly sized cookware on the triple surface element.
2. Push in and turn the control knob to the element size that best fits the cookware. (See [Figure 7](#)).
3. Turn the knob to adjust the setting if needed. Start most cooking operations on a higher setting and then turn to a lower setting to finish cooking. Each surface element provides a constant amount of heat at each setting. A glowing red surface heating area extending beyond the bottom edge of the cookware indicates the cookware is too small for the surface heating area.
4. When finished cooking, turn the control knob to **OFF** before removing the cookware.



Figure 8: Triple element options.

SETTING SURFACE CONTROLS

Warmer Zone

CAUTION

The warmer zone will not glow red when it is hot, but becomes hot enough to cause burns. Avoid placing hands on or near the warmer zone until the hot surface indicator light is off. Always use potholders or oven mitts when removing food from the warmer zone as cookware and plates will be hot.

Use the feature to keep cooked foods hot such as vegetables, gravies, casseroles, soups, stews, breads, and pastries at serving temperature.

Always start with hot food. Do not heat cold food on the warmer zone. All food placed on the warmer zone should be covered with a lid to maintain quality.

For best results, when warming pastries or breads, the cover should have an opening to allow moisture to escape. Do not use plastic wrap to cover food. Plastic may melt onto the surface and be very difficult to clean.

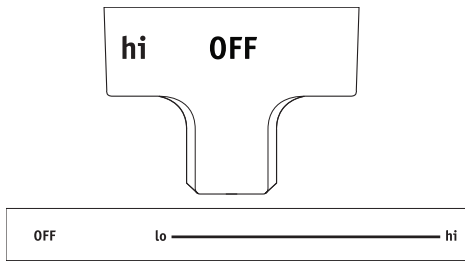

Figure 9: Warmer zone control knob

To set the warmer zone control:

1. Turn the warmer zone control knob clockwise to the desired heat setting. The warmer zone is designed to keep foods at serving temperature.
2. When ready to serve, turn the warmer zone control knob to the off position. The warmer zone will remain hot until the hot surface indicator light turns off. The warmer zone is on when the indicator light is on,

WARNING

Food Poisoning Hazard. Do not let food sit for more than one hour before or after cooking. Doing so can result in food poisoning or sickness.

Bridge Control

On the left side of the cooktop there are two single elements with a bridge element between them. When turned on, the bridge control allows for a larger cooking area by cycling at the same temperature as the left front element and can accommodate specialized cookware.

To operate the bridge element:

1. Turn the control knob clockwise to activate the front element and the bridge element.
2. To turn on the front element only, turn the control knob counter-clockwise to the desired setting.
3. When the bridge element is active, it will maintain the same heat setting as the left front element.

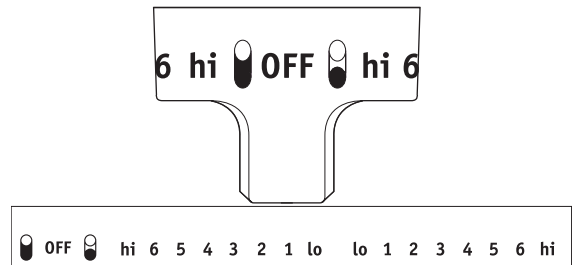
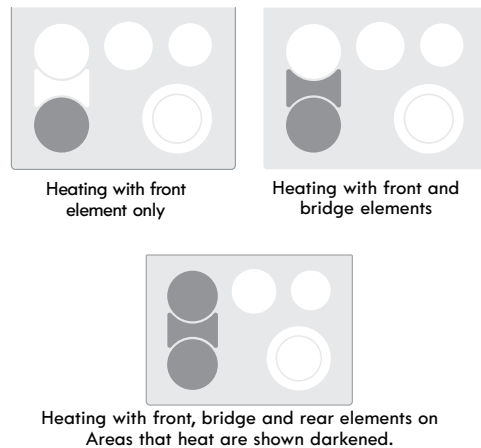

Figure 10: Bridge control



CAUTION

Use only cookware specifically designed for use with the bridge element.

BEFORE SETTING OVEN CONTROLS

Oven Vent Location

When the oven is on, warm air is released through the vent. This venting is necessary for proper air circulation in the oven and good baking results. Do not block oven vent. Never close off the openings with aluminium foil or any other material. Steam or moisture may appear near the oven vent. This is normal.

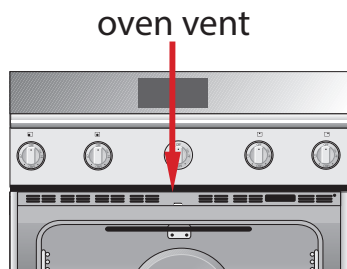

Figure 11: Do not block oven vent location

WARNING

Protective Liners — Do not use aluminum foil to line the oven bottom. Only use aluminum foil as recommended in this manual. Improper installation of these liners may result in risk of electric shock or fire.

IMPORTANT

Remove all oven racks and clean according to instructions provided in the Care & Cleaning section of this manual. Never pick up hot oven racks or parts.

Type of oven racks

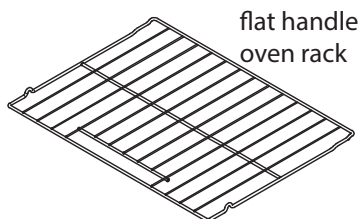

Figure 12: Oven rack types

Flat handle racks may be used for most cooking needs and may be placed in most oven rack positions.

CAUTION

Always use pot holders or oven mitts when using the oven. When cooking, the oven interior and exterior, oven racks, and cooktop will become very hot which can cause burns.

Ladder Racks and Support

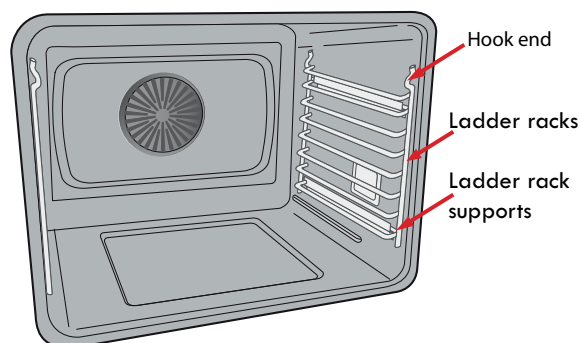

Figure 13: Install ladder racks securely on ladder rack supports

Important: When installing ladder racks be sure the hook end is near the top of the oven cavity.

Removing, replacing, and arranging flat or offset oven racks

To arrange - Always arrange the oven racks when the oven is cool (prior to operating the oven).

To remove - For ease of removal, racks should not be placed in adjacent rack positions. Pull the oven rack straight forward until it reaches the stop position. Lift up front of oven rack slightly and slide out.

To replace - Place the oven rack on the rack guides on both sides of oven walls. Tilt the front of oven rack upward slightly and slide the oven rack back into place. Be sure oven racks are level before using.

IMPORTANT

Do not line the oven walls, racks, bottom or any other parts of the range with aluminum foil. Doing so will alter heat distribution and may cause permanent damage to the oven interior. During self clean the oven temperatures will be hot enough to melt foil.

OVEN CONTROLS

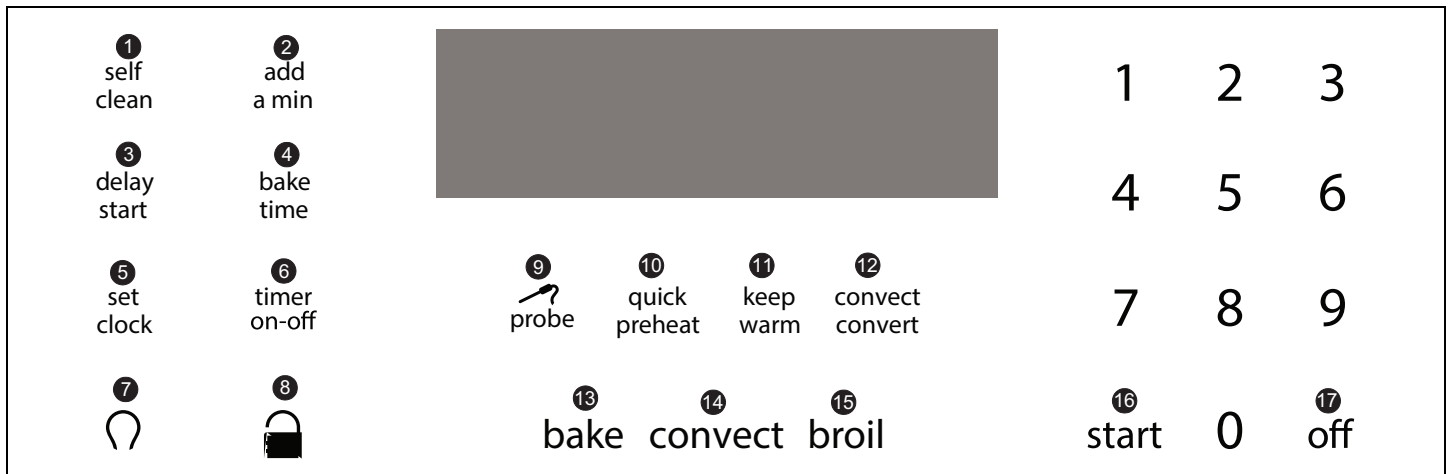

- 1. Self Clean** - Use to select 2, 3, or 4 hr Self-Clean cycle.
- 2. Add a Minute** - Use to add one minute to the timer. This works with the kitchen timer and does not affect any cook time or start time functions.
- 3. Delay Start** - Use with Bake, Convection Bake, Convection Convert, and Self Clean functions to program a delayed start time.
- 4. Bake Time** - Use to set a specific amount of time needed for cooking. Automatically cancels cooking process at end of set time.
- 5. Set Clock** - Use to set time of day.
- 6. Timer on/off** - Use to set and cancel the timer.
- 7. Light** - Use to turn internal oven light on and off.
- 8. Lock** - Use to lock oven door and oven controls. Will not affect operation of surface elements.
- 9. Probe** - Use to cook meat and poultry to the perfect internal temperature automatically.
- 10. Quick preheat** - Use to quickly raise oven to preheat temperature.
- 11. Keep Warm** - Maintains low heat to keep food warm at serving temperature.
- 12. Convection Convert** - Use to select the convection convert function.
- 13. Bake** - Use to start a normal Bake function.
- 14. Convection** - Use to toggle between convection bake, convection roast, and convection broil.
- 15. Broil** - Use to select Broil function.
- 16. Start** - Use to start oven functions.

- 17. Off** - Use to cancel any oven function previously entered except clock and timer.

Minimum and maximum settings

All of the features listed have minimum and maximum time and temperature settings that may be entered into the control. An entry acceptance beep will sound each time a key is touched. An entry error tone (three short beeps) will sound if the entry of the temperature or time is below the minimum allowable setting or above the maximum setting for the cooking feature.

Feature	Min. Temp or Time	Max. Temp or Time
Bake	170°F (77°C)	550°F (288°C)
Broil	400°F (205°C)	550°F (288°C)
Quick Preheat	170°F (77°C)	550°F (288°C)
Convection Broil	400°F (205°C)	550°F (288°C)
Convection Roast	170°F (77°C)	550°F (288°C)
Convection Bake	170°F (77°C)	550°F (288°C)
Self Clean	2 Hours	4 Hours
Keep Warm	170°F (77°C)	3 Hours
Bake Time	1 Minute	5:59
Delay Time 12 Hr.	1:00	12:59
Delay Time 24 Hr.	0:00	23:59
Probe	140°F(60°C)	210°F(99°C)
Timer	1 minute	11 hrs. 59 mins.
Clock 12 Hr.	1:00	12:59
Clock 24 Hr.	0:00	23:59

Setting the Clock

When the appliance is first powered up, **12:00** will flash in the display (Figure 14). The time of day must first be set before operating the oven.



Figure 14: 12:00 in display before setting the clock

To set clock to 1:30:

1. Press **set clock**.
2. Enter **1 3 0** using numeric keypad.
3. Press **start**.

Note: The clock cannot be changed when a Bake Time, Self Clean, Delay Start, or cooking feature is active.

Setting 12 Hour or 24 Hour display mode

The clock display mode allows you to select 12 hr or 24 hr modes. The factory pre-set clock display mode is 12 hours.

To set 12 hr or 24 hr display mode:

1. Press and hold **set clock** for 6 seconds.
2. Press **self clean** to toggle between **12 Hr day** or **24 Hr day** display modes (Figure 15).
3. Press **start** to accept the choice.



Figure 15: 12 Hr day and 24 Hr day settings

Setting Timer

The minute timer allows you to track your cooking times without interfering with the cooking process. The timer may be set from a minimum time of 1 minute to a maximum of 11 hours and 59 minutes.

To set timer for 5 minutes:

1. Press **Timer ON/OFF**.
2. Enter 5 using numeric keypad.
3. Press **start** to start the timer. When set time ends, **END** will show in the display and the control will sound a beep three times every 30 seconds until **Timer ON/OFF** key is pressed.

To cancel the timer when active, press **Timer ON/OFF** again.

Important note:

- The timer does not start or stop the cooking process. It serves as an extra minute timer that will beep when the set time has run out. The timer may be used alone or while using any of the other oven functions.
- When timer is set for more than 1 hour it will display hours and minutes until 1 hour remains. When less than 1 hour remains, the display counts down in minutes and seconds. With less than 1 minute remaining, only seconds will display.
- If the timer is active during a cooking process, the timer will show in the display. To view the status of any other active oven function, press the key of the cooking function once and it will appear in the display for a few seconds.

Add a Min

Use the **add a min** feature to set additional minutes to the timer. Each press of the key will add 1 additional minute. If **add a min** is pressed when the timer is not active, the timer will activate and begin counting down from 1 minute.

To add 2 minutes to the timer:

Press **add a min** twice.

OVEN CONTROLS

Changing between continuous bake setting or 6 hour energy saving

The oven control has a factory preset built-in 6 Hour Energy Saving feature that will turn off the oven if the oven is left on for more than 6 hours. The control may be programmed to override this feature to bake continuously.

To change between continuous bake or 6 hour energy saving feature:

1. Press and hold **Timer ON/OFF** for 6 seconds
2. Press **self clean** to toggle between **6 Hour OFF** or **Stay On** feature (Figure 16).
3. Press **start** to accept choice.



Figure 16: 6 hr energy saving (L) and continuous setting (R)

Changing temperature display from Fahrenheit to Celsius

The electronic oven control is set to display °F when shipped from the factory. The display may be changed to show either °F or °C oven temperatures.

To change temperature display mode from °F to °C or from °C to °F:

1. Press and hold **Broil** for 6 seconds.
2. Once **F (or C)** appears in the display, press **self clean** to toggle between Fahrenheit and Celsius temperature display modes (Figure 17).
3. Press **start** to accept the choice.

Important note:

The oven temperature display cannot be changed during the cooking process or if a Delay Start has been set or Self Clean is active.



Figure 17: Display showing Fahrenheit and Celsius

Setting Silent or Audible Control mode

Silent mode allows the oven control to operate without audible tones. The control may be programmed for silent operation and later reset to operate with all the normal audible tones.

To set for silent or audible mode:

1. Press and hold **Delay Start** for 6 seconds.
2. Press the **self clean** key to toggle between **bBEEP On** or **bBEEP OFF** (Figure 18).
3. Press **start** to accept the choice.



Figure 18: Display showing audible and silent operation

Setting Oven Lockout



To activate the oven lockout features:

1. Be sure oven door is completely closed.
2. Press and hold the lock key for 3 seconds. The motor driven door latch mechanism will begin locking the oven door automatically. Do not open the oven door. Allow about 15 seconds for the oven door to completely lock. Once door is locked, the word **DOOR** with a lock icon will appear in the display.

To cancel the oven lockout feature:

1. Press and hold the lock key for 3 seconds. The motor door latch will begin unlocking the oven door automatically. Do not open the oven door. Allow about 15 seconds for the oven door to completely unlock.
2. When the word **DOOR** with a lock icon no longer displays, the oven door may be opened, and the oven control keypad will be available for use.

Important note:

- To avoid damage to the oven door latching mechanism, do not attempt to open or close the oven door whenever the word **DOOR** with a lock icon is displayed.
- If a control key is pressed when oven lockout is active, the control will triple beep indicating the key action is not available when the oven lockout feature is active.

OVEN CONTROLS

Operating Oven Lights

The interior oven lights will automatically turn on when the oven door is opened. Oven lights will not operate during a self clean cycle.

Press  to turn the interior oven lights on and off whenever the oven door is closed.

The interior oven lights are located on the rear wall of the oven interior and are covered with a glass shield. The glass shield protects the bulb from high temperatures and should always be in place whenever the oven is in use.

To replace the interior oven light, see [“Replacing the Oven Lights”](#) on [page 37](#).

Quick Preheat

Quick Preheat is available for your convenience and can be programmed for temperatures between 170F and 550F. Follow the recipe or package directions for food preparation time and temperature. When quick preheat is complete, a reminder tone will sound and food should be placed in the oven. During quick preheat function, the bake, broil and convection elements will cycle on and off. Depending on your preference for doneness and type of pan used, cooking times may vary. Watch food closely.

Important:

- Always place in center of the oven on rack position 5 ([Figure 20](#)) and place the food as shown in [Figure 19](#).
- For best results when baking batter and dough-based items such as cakes, cookies and pastries, use convection bake function and place food in oven when the reminder tone sounds.
- For crispy crust on pizza use Bake function and place food in oven when reminder tone sounds.

CAUTION

Always use pot holders or oven mitts when using the oven. When cooking the oven interior, oven racks, and cooktop will become very hot which can cause burns.

To set the preheat temperature for 350°F:

1. Arrange the interior oven racks.
2. Press **quick preheat**. 350 will appear in the display.
3. Press start.
4. 350 and PREHEAT will be displayed while the oven is preheating.
5. Press **off** when baking is complete or to cancel the preheat feature.

To change preheat temperature while oven is preheating (ex: changing from 350°F to 425°F):

1. Press **quick preheat**. 350 will appear in the display.
2. Enter the new preheat temperature. Press **4 2 5**.
3. Press start. 425 will show in the display.
4. When baking is complete, press off.

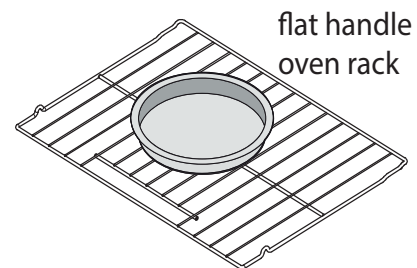

Figure 19: Single rack baking pan position

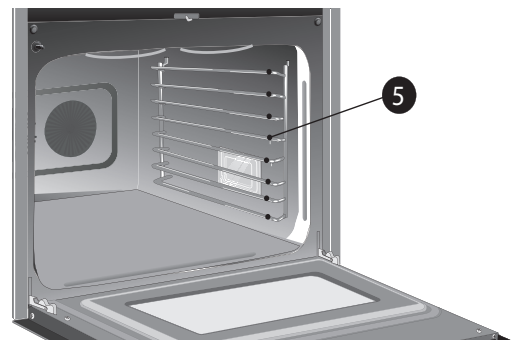

Figure 20: Oven rack position (5)

OVEN CONTROLS

Setting Bake

Use the bake feature whenever the recipe calls for baking using normal temperatures. A reminder tone will sound indicating when the set bake temperature is reached and to place the food in the oven. When the oven is preheating, the convection fan will be on and will turn off once the set temperature is reached. The oven will cycle on and off while baking to maintain the set temperature and the bake element icon in the display will reflect the cycling of the bake element.

Bake may be set for any oven temperature between 170°F (77°C) to 550°F (288°C).

Baking tips

- For pastries and breads, use the convection bake function for best results when using multiple racks (“[Convection Bake](#)” on [page 21](#)).
- For layer cakes use the normal bake function.
- For best results when baking cakes or cookies using two oven racks, place racks in positions 3 and 7 ([Figure 22](#)) and place pans as shown in [Figure 21](#).
- Allow at least 2 inches (5 cm) of space between bakeware for proper air circulation.
- Dark or dull pans absorb more heat than shiny bakeware, resulting in dark or overbrowning of foods. It may be necessary to reduce the oven temperature or cook time to prevent overbrowning of some foods. Dark pans are recommended for pies. Shiny pans are recommended for cakes, cookies, and muffins.
- Glass cookware is a slow heat conductor. May require reducing oven temperature.
- Fully preheat the oven before cooking items like cookies, biscuits, and breads.
- When using any single rack, use rack position 5 so that the food is in the center of the oven.
- Do not open oven door often. Opening the door will reduce the temperature in the oven and may increase cooking time.

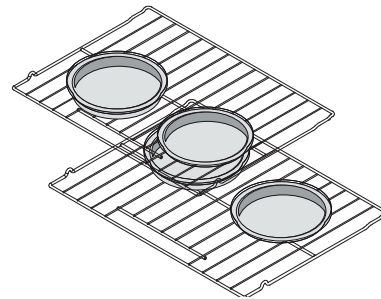

Figure 21: Baking on multiple levels in BAKE.

To set Bake for oven temperature of 425°F:

1. Press **bake**.
2. Enter **4 2 5** using numeric keypad.
3. Press **start**.
4. To cancel bake at any time, press **off**.

CAUTION

Always use pot holders or oven mitts when using the oven. When cooking the oven interior, oven racks, and cooktop will become very hot which can cause burns.

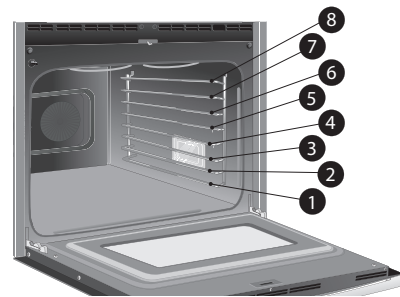

Figure 22: Oven rack positions

Important note:

The oven will bake no longer than 6 hours. If you wish to bake for a longer period, see “[Changing between continuous bake setting or 6 hour energy saving](#)” on [page 18](#) for detailed information.

OVEN CONTROLS

Convection Bake

Convection functions use a fan to circulate oven heat continuously around the oven. This improved heat distribution allows for even cooking and browning results. Heated air flows around the food from all sides. Breads and pastry brown more evenly.

Convection bake may be set for any oven temperature between 170°F (77°C) and 550°F (288°C).

Benefits of convection cooking include:

- Multiple rack baking.

Baking tips

- For pastries and breads, use the convection bake function for best results when using multiple racks.
- Fully preheat the oven before cooking items like cookies, biscuits, and breads.
- When using any single rack, use rack position 5 so that the food is in the center of the oven.
- When using two oven racks, place in positions 2 and 7 (Figure 23) and place bakeware as shown in Figure 24.
- When cooking with three oven racks, place racks on positions 2, 5, and 8.
- Dark or dull bakeware absorbs more heat than shiny bakeware. It may be necessary to reduce oven temperature and cook time to prevent overbrowning of some foods. Shiny bakeware is recommended for cakes, cookies, and muffins.
- Glass cookware is a slow heat conductor. May require reducing oven temperature.
- Use pans or cookware with low sides. This allows the air to circulate around food evenly.
- Unless the recipe is written for convection cooking, reduce oven temperature 25°F from recipe's recommended oven temperature. Follow the remainder of the recipe's instructions using the minimum recommended cook time.
- Do not open oven door often. Opening the door will reduce the temperature in the oven and may increase cooking time.

To set Convection Bake with a default oven set temperature of 350°F:

1. Press **convect** key once. Conv Bake and 350° will appear in the display.
2. Press **start**.

To cancel convection bake at any time, press **off**.

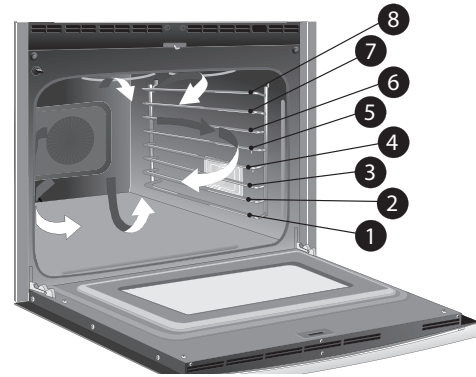

Figure 23: Air movement using convection

Important notes:

- If the oven door is opened when convection bake is active, the convection fan will stop rotating until the oven door is closed.
- When using convection bake, cook time reductions may vary depending on the amount and type of food being cooked.

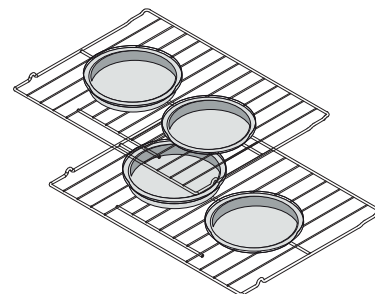

Figure 24: Baking on multiple levels in Convection Bake

OVEN CONTROLS

Setting Bake Time

Use bake time to set the amount of time needed for baking. The oven will turn on immediately and stop automatically after the set bake time ends.

To program oven to bake with oven default temperature of 350°F and to shut-off after 30 minutes:

1. Press **bake time**.
2. Enter **3 0** using numeric keypad.
3. Press **start** to accept.
4. Press **bake**.
5. Press **start**.

When the programmed bake time ends:

End will appear in the display window, and the oven will shut-off automatically (Figure 25). The oven control will beep three times every 30 seconds as a reminder until **Off** is pressed.



Figure 25: Display showing end of cooking

Important note:

- The bake time feature may be set with bake, convection bake, and convection roast. Bake time or delay start will not operate with the broil function.
- The maximum time setting is 11 hours and 59 minutes unless oven is set for continuous cooking.

To change the oven temperature or bake time after baking has started:

1. Press **bake** (for oven temperature) or **bake time**.
2. Press **numeric keys** to enter new temperature or bake time.
3. Press **start** to accept change.

Setting Delay Start

Delay Start sets a delayed starting time to oven cooking or cleaning functions. Prior to setting a delay start, be sure the time of day is set correctly.

To program oven for a delay start beginning at 5:30, to shut-off automatically after 50 minutes and for baking at 375°F:

WARNING

Food Poisoning Hazard. Do not let food sit for more than one hour before or after cooking. Doing so can result in food poisoning or sickness.

CAUTION

Always use pot holders or oven mitts when using the oven. When cooking the oven interior, oven racks, and cooktop will become very hot which can cause burns.

CAUTION

1. Press **bake time**.
2. Enter **5 0** using numeric keypad.
3. Press **start** to accept.
4. Press **Delay Start**.
5. Enter **5 3 0** using numeric keypad.
6. Press **start** to accept.
7. Press **Bake**.
8. Enter **3 7 5** using numeric keypad.
9. Press **start**.

When the programmed bake time ends: End will appear in the display window, and the oven will shut off automatically. The oven control will beep three times every 30 seconds as a reminder until the Off key is pressed.

Important note:

Delay Start may be set using a 24 hr clock. To set clock for 24 Hr operation, See [“Setting 12 Hour or 24 Hour display mode”](#) on [page 17](#) for more information. The Delay Start feature may be used with Convection Bake, Convection Roast, Convection Convert, Bake, Slow Cook, and Self Clean functions.

Setting Convection Convert

Pressing the Convection Convert key automatically converts the cooking temperature entered for any standard baking recipe to the lower temperature required for convection baking.

Important:

When Convection Convert is used with a timed Convection Bake setting the control will display a CF message when programmed and appear again as a reminder to check food when the bake time is 75% complete (Figure 26). At this time the oven control will sound one long beep at regular intervals until the set bake time has finished.



Figure 26: Check Food reminder shown in display.

To add Convection Convert to Convection Bake function using default oven set temperature of 350°F:

1. Press **Convect** once. Convection bake is selected.
2. Press **start**. Press **Convect Convert**.

To cancel Convection Convert at any time, press **off**.

To program oven for Convection Convert with oven default temperature of 350°F and to shut-off after 30 minutes:

1. Press **Convect once**. **Convection Bake** is selected.
2. Press **start**.
3. Press **bake time**.
4. Enter **3 0** using numeric keypad.
5. Press **start**.
6. Press **Convect Convert**.
7. To cancel Convect Convert at any time, press **off**.

Important note:

- Convection Convert may only be used with the Convection Bake function.
- The convection fan will begin rotating once Convection Bake has been activated.
- If the oven door is opened when any convection function is active, the convection fan will stop rotating until the oven door is closed.

Setting Convection Broil

Use this mode for thicker cuts of meat, fish, and poultry. The convection broiling gently browns the exterior and seals in the juices. Convection broiling uses the broil element and a fan to circulate the heat continuously within the oven.

The oven can be programmed for convection broiling at any temperature between 400°F to 550°F.

Convection broiling tips:

- For optimum browning, preheat the broil element for 2 minutes. Always pull the rack out to the stop position before turning or removing food.
- Always use a broiler pan and its grid when broiling. It keeps grease away from the high heat of the broil element.
- Do not use the broil pan without the insert. Do not cover the broil pan insert with foil. The exposed grease could catch fire. Broil one side until the food is browned; turn and cook on the second side. Season and serve.
- Convection broiling is generally faster than conventional broiling. Check for doneness at the minimum recommended time.

To set a convection broil temperature of 500°F:

1. Arrange oven racks first. Press **convect**. The display will show **350** and **convect** and **bake** will flash.
2. Press **convect** two more times. **550** and **convect** and **broil** will flash.
3. Press **5 0 0** using numeric keys. Press **start**.
4. **500, CONVECT, BROIL**, and the **fan icon** will show in the display.
5. Allow oven to preheat for 2 minutes then place food in the oven.

NOTE

The preheat tone will not sound for this feature.

OVEN CONTROLS

Setting Broil

Use the Broil function to cook meats that require direct exposure to radiant heat for optimum browning results. The Broil feature is factory preset to broil at 550°F. The Broil function temperature may be set at any temperature between 400°F (205°C) and 550°F (288°C).

⚠ WARNING

Should an oven fire occur, close the oven door and turn the oven off. If the fire continues, use a fire extinguisher. Do not put water or flour on fire. Flour may be explosive.

⚠ CAUTION

Always use pot holders or oven mitts when using the oven. When cooking, the oven interior, oven racks, and cooktop will become very hot which can cause burns.

Important notes:

- Broiling is direct heat cooking and will produce smoke. If smoke is excessive, place food further away from the broil element.
- Always arrange oven racks when the oven is cool.
- For best results use a broil pan with broil pan insert designed to drain the fat from the food and help avoid spatter and reduce smoking (Figure 27). If a broiler pan and insert are not supplied with this appliance, they may be purchased from frigidaire.com.
- Always pull the oven rack out to the stop position before turning or removing food.

To set Broil with the default broil oven temperature of 550°F:

1. Arrange the oven racks when cool. For optimum browning results, preheat oven for 2 minutes before adding food.
 2. Position bakeware in oven. Press **Broil**.
- Important:** Broil with the door closed. If oven door is open for more than one minute during Broil the control will beep. If door is not closed it will turn off Broil element after another 30 seconds.
3. Press **start**. The lowest setting the oven control will accept for Broil is 400°F. To adjust the Broil temperature, press **Broil** again and then enter the desired temperature using the number keys. Press Start to accept change.
 4. Broil on one side until food is browned; turn an broil other side until done to your satisfaction. When finished broiling, press **off**.
 5. To cancel Broil at any time, press **off**.

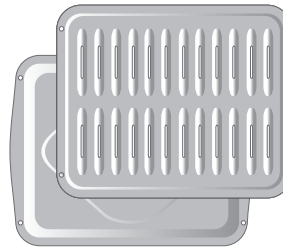

Figure 27: Broiler pan/insert

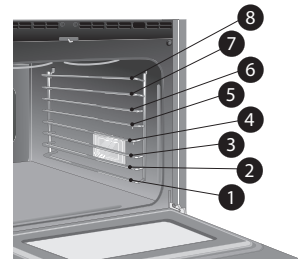

Figure 28: Rack positions

Food	Rack Position	Temperature	Cook time (minutes)		Internal Temperature	Doneness
			1st side	2nd side		
Steak 1" thick	8th	550°F (288°C)	5	5	140°F (60°C)	Rare*
Steak 1" thick	7th or 8th	550°F (288°C)	8	6	145°F (63°C)	Medium
Steak 1" thick	7th or 8th	550°F (288°C)	10	9	170°F (77°C)	Well
Pork Chops 3/4" thick	7th	550°F (288°C)	10	8	170°F (77°C)	Well
Chicken bone-in	5th or 6th	450°F (232°C)	22	12	170°F (77°C)	Well
Chicken boneless	5th or 6th	450°F (232°C)	10	8	170°F (77°C)	Well
Fish	7th	500°F (260°C)	15	n/a	170°F (77°C)	Well
Shrimp	7th	550°F (288°C)	7	n/a	170°F (77°C)	Well
Hamburger 1" thick	8th	550°F (288°C)	11	9	145°F (63°C)	Medium
Hamburger 1" thick	7th	550°F (288°C)	12	10	170°F (77°C)	Well

* The U.S. Department of Agriculture states, "Rare fresh beef is popular, but you should know that cooking it to only 140°F (60°C) means some food poisoning organisms may survive." (Source: Safe Food Book, Your Kitchen Guide, USDA Rev. June 1985.) The lowest temperature recommended by the USDA is 145°F (63°C) for medium rare fresh beef. For well done 170°F (77°C). NOTE: Broiling is direct heat cooking and will produce some smoke. If smoke is excessive, place food further away from element. Always watch foods carefully to prevent burning.

OVEN CONTROLS

Convection Roast

Convection roast combines a cook cycle with the convection fan and element to rapidly roast meats and poultry. Heated air circulates around the meat from all sides, sealing in juices and flavors. Meats cooked with this feature are crispy and brown on the outside while staying moist inside.

Convection Roasting tips:

- Preheating for convection roast will not be necessary for most meats and poultry.
- Arrange oven racks so the food is on the lowest rack of the oven.
- Since convection roast cooks faster, you can reduce cook times as much as 25% from the recommended time of your recipe (check the food at this time). Then if needed, increase cook time until the desired doneness is obtained.
- Carefully follow your recipe's temperature and time recommendations or refer to the convection roast recommendations for additional information.
- Do not cover foods when dry roasting - covering will prevent the meat from browning properly.
- When cooking meats use the broiler pan and insert. The broiler pan will catch grease spills and the insert helps prevent grease splatters.

CAUTION

Do not use the broiler pan without the insert. Do not cover the broil pan or insert with aluminum foil; the exposed grease could ignite. Do not cover the broiler insert with aluminum foil. Exposed fat and grease could ignite.

To use convection roast at a temperature of 350°F (177°C):

1. Place oven rack on the bottom or next to the bottom oven rack position.
2. Place the meat on the broiler pan and insert. Make sure the insert is securely seated on top of the broiler pan. Do not use the broiler pan without the insert.
3. Place meat (fat side up) on insert
4. Place prepared food on oven rack and slide into oven.
5. Close the door.
6. Press the **convect** key twice. **Roast** will appear in the display.
7. Press **start**.
8. When cooking is completed or to cancel convection roast press **off**.

Table 2: Convection roasting temperature and time recommendations

Meat		Weight	Oven Temp	Internal Temp	Minutes per lb.
Beef	Standing rib roast*	4 to 6 lb.	350°F (177°C)	*160°F (71°C)	25-30
	Rib eye roast*	4 to 6 lb.	350°F (177°C)	*160°F (71°C)	25-30
	Tenderloin roast	2 to 3 lb.	400°F (204°C)	*160°F (71°C)	15-25
Poultry	Turkey whole**	12 to 16 lb.	325°F (163°C)	180°F (82°C)	8-10
	Turkey whole**	16 to 20 lb.	325°F (163°C)	180°F (82°C)	10-15
	Turkey whole**	20 to 24 lb.	325°F (163°C)	180°F (82°C)	12-16
	Chicken	3 to 4 lb.	350°F-375°F (177°C-191°C)*	180°F (82°C)	12-16
Pork	Ham roast, fresh	4 to 6 lb.	325°F (163°C)	160°F (71°C)	30-40
	Shoulder blade roast	4 to 6 lb.	325°F (163°C)	160°F (71°C)	20-30
	Loin	3 to 4 lb.	325°F (163°C)	160°F (71°C)	20-25
	Pre-cooked ham	5 to 7 lb.	325°F (163°C)	160°F (71°C)	30-40

* The U.S. Department of Agriculture states, "Rare fresh beef is popular, but you should know that cooking it to only 140°F (60°C) means some food poisoning organisms may survive." (Source: Safe Food Book, Your Kitchen Guide, USDA Rev. June 1985.) The lowest temperature recommended by the USDA is 145°F (63°C) for medium rare fresh beef. For well done 170°F (77°C)** Stuffed turkey requires additional roasting time. Shield legs and breast with foil to prevent over browning and drying of the skin.

OVEN CONTROLS

Cooking with Meat Probe

CAUTION

Do not use kitchen utensils to pull on the probe cable or handles. Always insert and remove the probe using the provided handles, as shown in [Figure 29](#), and always use a pot holder to protect hands from possible burns.

Use the probe feature for best results when cooking foods such as roasts, hams, or poultry.

For meats like poultry and roasts, using a probe to check internal temperature is the safest method to ensure properly cooked food.

The probe feature, when set correctly will signal an alert when the internal food temperature reaches the desired set target temperature.

When active, the probe displays the internal food temperature which is visible in the display during the cooking process. This eliminates any guesswork or the need to open the oven door to check the thermometer.

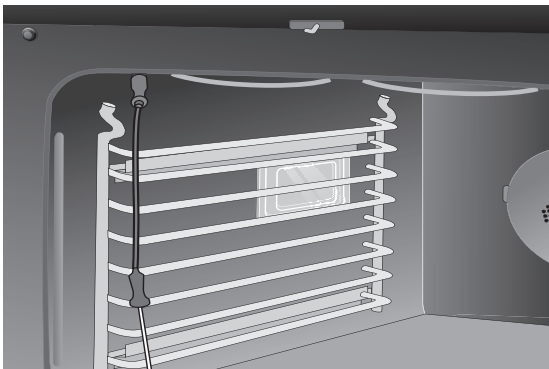

Figure 29: Using the probe

IMPORTANT

Do not store the probe inside the oven. Use only the original probe provided. Connecting any other probe or device could result in damage to the oven control, electronics, and the receptacle.

Before starting self clean, double check that the probe is removed from the oven interior. Defrost frozen foods completely before inserting the probe.

Proper placement of probe in food.

- Insert the probe so that the probe tip rests inside the center of the thickest part of meat or food (See [Figure 30](#)). For best results, do not allow the probe temperature sensor to contact bone, fat, gristle, or the cookware.

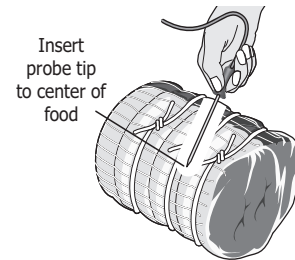

Figure 30: Probe in thickest area of food

- For bone-in ham or lamb, insert the probe into the center of lowest large muscle or joint.
- For meat loaf or casseroles, insert the probe into center of food.
- When cooking fish, insert meat probe just above the gill.
- For whole poultry or turkey, fully insert the probe sensor into the thickest part of the breast (See [Figure 31](#)).

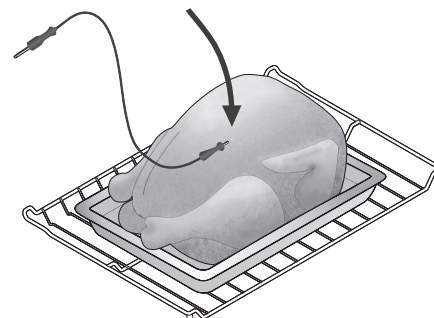

Figure 31: Probe in thickest part of breast

OVEN CONTROLS

To set probe:

1. Insert the probe into the food. Place prepared food on the desired oven rack position and slide into the oven.
2. Plug the connector end of the probe all the way into the probe receptacle while the oven is still cool. The receptacle is located on the upper left front oven cavity wall (See Figure 29).
3. When the probe is set, an acceptance tone will sound, the probe icon will illuminate, and the actual probe temperature appears in the display (See Figure 32). Close the oven door.



Figure 32: Probe set showing probe temperature

4. Press **probe** key once. Enter the desired target food temperature using the numeric keys and set temperature for food type. The minimum setting is 140°F (60°C); the maximum is 210°F (99°C). Default is 170°F (77°C).
5. Press **start** to accept the target temperature.
6. Set for **quick preheat, bake, convection bake, convection roast, or convection convert**, and if necessary adjust the oven temperature accordingly.
7. The control will provide three beeps when the internal target temperature is reached. The oven will automatically change to keep warm and the actual probe temperature will remain in the display. Keep warm will maintain the oven temperature at 170°F (77°C) for 3 hours unless otherwise cancelled.

To stop cooking at any time, press **off**.

NOTE

During cooking the internal food temperature will display by default. To see the target temperature press the probe key once. After 6 seconds the display will revert to the internal food temperature.

To assure accuracy, do not remove the probe from the food or receptacle until the desired internal temperature is reached. If the probe is removed from the receptacle only, the probe feature will cancel but the oven will continue to cook. If the probe is removed from the food only, the probe feature will remain active and may eventually generate a probe too hot message.

Table 3: USDA recommended minimum internal cooking temperatures

Food Type	Internal Temp.
Ground meat and meat mixtures	
Beef, Pork, Veal, Lamb	160°F (71°C)
Turkey, Chicken	165°F (74°C)
Fresh beef, veal, lamb	
Medium rare +	145°F (63°C)
Medium	160°F (71°C)
Well Done	170°F (77°C)
Poultry	
Chicken and Turkey, whole	165°F (74°C)
Poultry Breasts, Roasts	165°F (74°C)
Poultry Thighs, Wings	165°F (74°C)
Duck and Goose	165°F (74°C)
Stuffing (cooked alone or in bird)	165°F (74°C)
Fresh Pork	
Ham	
Fresh (raw)	160°F (71°C)
Pre-cooked (to reheat)	140°F (60°C)
Eggs dishes	
Leftovers and Casseroles	165°F (74°C)

The U.S. Department of Agriculture states, "Rare fresh beef is popular, but you should know that cooking it to only 140°F (60°C) means some food poisoning organisms may survive." (Source: *Safe Food Book, Your Kitchen Guide*, USDA Rev. June 1985.)

Visit the USDA Food Safety and Inspection website at www.fsis.usda.gov

Note: To change the target temperature while cooking, press the probe key once. Use the numeric keys to change the temperature. Press the start key to accept any change.

OVEN CONTROLS

To set how the oven will operate once the probe reaches the target temperature:

The oven is preset to automatically stop cooking and start the warm feature when probe sensor reaches the target temperature. This may be set to continue cooking if desired. Setting the options once the probe reaches the target temperature must be done when the oven is inactive. The probe is not required to be connected to the probe receptacle when setting this option.

To set the oven to continue cooking after reaching the target temperature:

1. Press **probe** key and hold for 6 seconds.
2. Press **self clean** key and toggle until **Continu** appears, as shown in [Figure 33](#), then press **start** to accept.



Figure 33: Probe set to continue cooking

To set the oven to automatically stop cooking and start warm once reaching target temperature:

1. Press **probe** key and hold for 6 seconds.
2. Press the **self clean** key and toggle until **CAnCEL** appears, as shown in [Figure 34](#), then press **start** to accept.



Figure 34: Probe set to cancel cooking

Probe too hot message:

When the message **Prob... Too... Hot...** flashes in the display, the probe temperature has exceeded 250°F (121°C). If the probe is not removed, this message may continue until the sensor reaches 300°F (149°C) or higher, and oven will automatically turn off. Be sure the probe sensor is fully covered by the food.

Keep Warm

Keep Warm should only be used with foods that are already at serving temperatures. Keep warm will keep cooked foods warm and ready for serving for up to 3 hours after cooking has finished. After 3 hours the oven will shut-off automatically. Keep Warm will keep the oven temperature at 170° F (77°C).

To set Keep Warm:

1. If needed, arrange oven racks and place cooked food in oven.
2. Press **Keep Warm: KEEP WARM** will appear in the display. (If no other keys are touched within 25 seconds the request for Keep Warm will clear.)
3. Press **start**. Keep Warm will automatically turn on and then turn off after 3 hours unless cancelled.

To turn Keep Warm off at any time, press **off**.

WARNING

Food poisoning hazard. Do not let food sit for more than one hour before or after cooking. Doing so can result in food poisoning or sickness. Foods that can easily spoil such as milk, eggs, fish, meat or poultry, should be chilled in the refrigerator first. Even when chilled, they should not stand in the oven for more than 1 hour before cooking begins, and should be removed promptly when finished cooking.

To add Keep Warm to turn ON after baking 45 minutes with a set temperature of 425°F:

1. Press **Bake Time**.
2. Enter **4 5** using numeric keypad.
3. Press **start**.
4. Press **Bake** and enter **425** on numeric keypad.
5. Press **start** to accept.
6. Press **Keep Warm**. **KEEP WARM** will appear in the display.
7. Press **start**. When the bake time is over, Keep Warm will automatically turn ON. Keep Warm function will automatically turn OFF after 3 hours unless canceled sooner.

Note: Keep Warm may be set when finished cooking or may be added to automatically turn on after cooking using Bake Time. Delay Start may also be added.

OVEN CONTROLS

Setting the Sabbath Feature (for use on the Jewish Sabbath and Holidays)

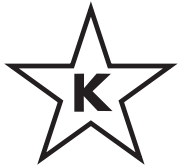

For further assistance, guidelines for proper usage, and a complete list of models with the Sabbath feature, please visit the web at www.star-k.org.

This appliance provides special settings for use when observing the Jewish Sabbath/Holidays. Sabbath mode disables all audible tones or visual display changes on the oven control. Bake heating is the only cooking feature available while in the Sabbath mode. Oven controls are locked during Sabbath mode. You must first set the Bake feature and temperature(s) needed for the oven, the Bake Time, and Delay Start options (if needed). Any settings made prior to setting the Sabbath mode will be visible in the displays. The Bake Time option, if set prior to the Sabbath mode, will give one audible alert at the end of Bake Time.

The Sabbath mode will override the factory preset 6 hour energy saving mode, and the appliance will stay on until the cooking features are cancelled. If any of the cooking features are cancelled when the appliance is in the Sabbath mode, no audible or visual indicators will be available to verify the cancellation.

If the oven interior lights are needed, be sure to activate them prior to setting the Sabbath mode. Once the oven light is turned on and the Sabbath mode is active, the oven light will remain on until the Sabbath mode is turned off and the oven lights are turned off. The oven door will not activate the interior oven lights when the oven door is opened or closed.

It is recommended that any oven temperature modification made within an active Sabbath mode be followed with two presses of the **start** key. This will insure the oven remains on even if an attempt is made to set the oven temperature outside of its temperature range. If the oven temperature is set outside of the temperature range, the oven will default to the nearest available temperature. Try to set the desired oven temperature again.

WARNING

Food poisoning hazard. Do not let food sit for more than one hour before or after cooking. Doing so can result in food poisoning or sickness.

To program oven to Bake with default oven temperature of 350°F and activate the Sabbath feature:

1. Be sure the clock is set with the correct time of day.
2. Arrange oven racks, place bakeware in oven, and close oven door. Press **Bake**.
3. Press **start**.
4. Note: If a bake time or delay start are desired enter the times at this point. See "[Setting Bake Time](#)" and "[Setting Delay Start](#)" on [page 22](#) for detailed instructions.
5. Press and hold **bake time** and **delay start** simultaneously for about 3 seconds to set the Sabbath feature. Once the feature is set, **SAb** will appear in the display indicating the oven is properly set for the Sabbath feature.



Important note:

- Do not attempt to activate any other oven function except Bake while the Sabbath feature is active. The following keys will function correctly when the Sabbath feature is active: 0-9 number keypad, Bake, **start**, and **off**. All other keys should not be used once the Sabbath feature is active.
- You may change the oven temperature once baking has started. Press **bake**, use the numeric keypad to enter the oven temperature change (170°F to 550°F), and press **start** (for Jewish Holidays only).
- Remember that the oven control will no longer provide audible tones or display any further changes when the Sabbath feature is active.
- The oven will shut-off automatically after completing a bake time, delay start, or keep warm and therefore may only be used once during the Sabbath/Jewish Holidays.
- If a delay start time longer than 11 hours and 59 minutes is desired, set the oven control for the 24 hour day display mode setting. See "[Setting 12 Hour or 24 Hour display mode](#)" on [page 17](#) for more information.

To turn the oven off and keep the Sabbath feature active:

1. Press **off**.

OVEN CONTROLS

To turn off the Sabbath feature:

Press and hold both **bake time** and **delay start** simultaneously for at least 3 seconds to turn the Sabbath feature off. The control will provide an acceptance tone, and **SAb** will disappear from the display. The oven is no longer programmed for the Sabbath feature.

What to do during a power failure or power interruption after the Sabbath feature was activated:

Should you experience a power failure or interruption, the oven will shut-off. When power is restored the oven will not turn back on automatically. The oven will remember that it is set for the Sabbath, and the oven display will show the message **SF** for Sabbath failure.



The food may be safely removed from the oven while still in the Sabbath feature, however the oven cannot be turned back on until after the Sabbath/Holidays. After the Sabbath observance turn off the Sabbath feature.

Press and hold both **Bake Time** and **Delay Start** keys for at least 3 seconds simultaneously to turn the Sabbath feature off. **SF** will disappear from the display, and the oven may be used with all normal functions.

Restoring Factory Default Settings

Your appliance was set with predetermined (default) oven control settings. Over time, users may have made changes to these settings. The following options may have been modified since the appliance was new:

- 12 or 24 hr display mode
- Meat Probe Continue Cooking /Cancel Cooking and start Keep Warm
- Continuous bake or 6 hour energy savings mode
- Silent or audible control
- Oven temperature display (Fahrenheit or Celsius)
- Oven temperature adjustments (UPO)

CAUTION

If you choose to restore any of the options to a factory default setting using this method, all of the above user settings will be restored to the factory default settings.

To restore oven control to factory default settings:

1. Press and hold **7** on numeric keypad until acceptance tone sounds (about 6 seconds).
2. Press **start**. The control has been reset with the default settings.

Adjusting Oven Temperatures

Your appliance has been factory calibrated and tested to ensure accurate baking temperatures. For the first few uses, follow your recipe times and temperature recommendations carefully. If you think the oven is cooking too hot or too cool for your recipe times, you may adjust the control so the oven cooks hotter or cooler than the oven temperature displayed.

Important: Do not use oven thermometers such as those found in grocery stores to check the temperature settings inside your oven. These oven thermometers may vary as much as 20 to 40°F degrees from actual temperatures.

The oven temperature may be increased as much as +35°F (+19°C) or decreased -35°F (-19°C) from the factory calibrated settings.

To increase or decrease the oven temperature by 20°F:

1. Press and hold **Bake** until the control produces an audible tone (about 6 seconds). The factory offset temperature of 0 (zero) should appear in the display.
2. Enter **2 0** using numeric keypad.
3. To offset the oven by -20°F, press **self clean** to toggle between + and -.
4. Press **START** to accept the choice.

Important note:

- Oven temperature adjustments will not change the Broil or Self Clean function temperatures.
- The oven temperature adjustment may be made if your oven control is set to display temperatures in °C (Celsius). Minimum and maximum settings for Celsius range from plus (+)19°C to minus (-) 19°C.

OVEN CONTROLS

Self Clean

Read before starting Self Clean. Be sure to read all following caution and important statements before starting a self clean cycle.

A self cleaning oven cleans itself with high temperatures (well above normal cooking temperatures), which eliminate soils completely or reduces them to a fine powdered ash you can wipe away afterwards with a damp cloth. This function can be programmed for 2, 3, or 4 hours.

CAUTION

- Do not leave small children unattended near appliance. During self clean cycle, the outside of the oven can become very hot and cause burns if touched.
- Do not line the oven walls, racks, oven bottom, or any part of the range with aluminum foil. This will cause permanent damage to the oven interior and destroy heat distribution, and will melt to the oven interior.
- Do not force the oven door open. This will damage the automatic door locking system. Use caution when opening the oven door after the self clean cycle ends. The oven may still be very hot and cause burns. To avoid possible burns, stand to side of oven when opening door to allow steam or hot air to escape.
- The health of some birds is extremely sensitive to fumes given off during the self clean cycle of any range. Move birds to a well ventilated room
- The oven bake and broil elements may appear to have cooled after they have been turned off. These elements may still be hot and burns may occur if elements are touched before they have cooled. To avoid possible burns, stand to side of oven when opening door to allow steam or hot air to escape.

Important notes:

- Completely remove all oven racks and any accessories from oven cavity to avoid damage to oven racks. If the oven racks are not removed they may discolor.
 - Remove all items from the oven and cooktop including cookware, utensils, and any aluminum foil. Aluminum foil will not withstand high temperatures from a self clean cycle and will melt.
 - Do not use oven cleaners or oven protective coatings in or around any part of the oven interior.
- Clean any soil from the oven frame, the door liner outside the oven door gasket, and the small area at the front center of the oven bottom (Figure 35). These areas heat sufficiently to burn soil on. Clean using soap and water prior to starting Self Clean.
 - Remove any excessive spills. Any spills on the oven bottom should be wiped up and removed before starting a Self Clean cycle. To clean use hot, soapy water and a cloth. Large spills can cause heavy smoke or fire when subjected to high temperatures.
 - Do not allow food spills with high sugar or acid content (such as milk, tomatoes, sauerkraut, fruit juices, or pie fillings) to remain on the surface as they may leave a dull spot even after cleaning.
 - Do not clean the oven door gasket. The woven material in the gasket is essential for a good seal. Care should be taken not to rub, damage, or remove the oven door gasket. Doing so could cause damage to the door gasket and compromise the performance of the oven.

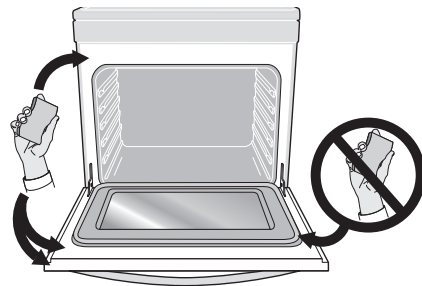

Figure 35: Areas to clean and to avoid

- The kitchen area should be well ventilated using an open window, ventilation fan, or exhaust hood during the first Self Clean cycle. This will help eliminate the normal odors.
- Do not attempt to open the oven door when the OVEN LOCK indicator light is flashing. Allow about 15 seconds for the motorized door latch mechanism to completely lock or unlock the oven door.
- When the clean time finishes, the oven door will remain locked until the range has cooled sufficiently. In addition to the clean time that was programmed, you must allow about 1 additional hour for the oven to cool before you will be able to open the oven door.

OVEN CONTROLS

Setting Self Clean

To set self clean:

1. Be sure the oven is empty and all oven racks are removed. Remove all items from the oven. Be sure oven door is completely closed.
2. Press **Self Clean** and the default 3 hour clean time will appear in the display. You may accept the default 3 hour clean time by going to step 3, or choose a different clean time by continuing to press **Self Clean** to select 2 hours or 4 hours. Once you have the desired clean time selected proceed to Step 3.
3. Press **start** to activate Self Clean.
2. As soon as Self Clean becomes active, a motor driven lock mechanism will begin locking the oven door automatically. Do not attempt to open the oven door (allow 15 seconds for the lock mechanism to lock the oven). Once the oven door has locked, **CLEAN** will appear in the display indicating Self Clean has started.

CAUTION

Do not force the oven door open when self-clean is active. This can damage the automatic door-locking system. Use caution when opening the door after self-clean cycle is complete; the oven may still be very hot.

When Self Clean is finished:

CAUTION

Use caution when opening the oven door after self cleaning. The oven may still be very hot and can cause burns. To avoid possible burns stand to the side of the oven when opening the oven door to allow hot air or steam to escape.

1. **CLEAN** message will turn off, and **Hot** will appear in display window.
2. Once the oven has cooled down (about 1 hour) and **Hot** is no longer displayed, the oven door may be opened.
3. When the oven interior has completely cooled, wipe away any residue or powdered ash with a damp cloth or paper towel.

Important: Do not force the oven door open when self-clean is active. This can damage the automatic door-locking system. Use caution when opening the door after self-clean cycle is complete; the oven may still be very hot.

Setting Delay Start Self Clean

To start a delay Self Clean with default clean time of 3 hours and a start time of 9:00 o'clock:

1. Be sure the clock is set with the correct time of day, the oven is empty, and all oven racks are removed. Be sure oven door is completely closed.
2. Press Delay Start.
3. Using numeric keypad, enter **9 0 0**.
4. Press **start** to accept
5. Press Self Clean.
6. Press **start**.

If it becomes necessary to stop Self Clean when active:

1. Press **off**.
2. If Self Clean has heated the oven to a high temperature, allow enough time for the oven to cool.
3. Before restarting Self Clean, be sure to read important notes below.

Important note:

- If your clock is set with the (default) 12 hr display mode, the Delay Start for a Self Clean can only be programmed to start up to 11 hours and 59 minutes after the time showing in the display (be sure to set the clock to current time before programming a delay start). To set a Delay Start Self Clean to begin 12 or more hours (maximum is 23 hours and 59 minutes) after the time of setting, be sure to first set the control in the 24 Hr display mode.
- If Self Clean was active and then interrupted by a power failure or cancelled before the oven was thoroughly cleaned, it may be necessary to run another Self Clean cycle.
- If the oven temperature was high enough when Self Clean was interrupted the oven control may not allow another Self Clean cycle to be set for up to 4 hours.

CARE AND CLEANING

Cleaning Various Parts of Your Oven

Before cleaning any part of the oven, be sure all controls are turned off and the oven is cool. Remove spills and any heavy soiling as soon as possible. Regular cleaning will reduce the number of major cleaning later.

Surface Type	Recommendation
Aluminum and Vinyl	Use hot, soapy water and a cloth. Dry with a clean cloth.
Painted and plastic control knobs Painted body parts Painted decorative trims	Using a soft cloth, clean with mild dish detergent and water or a 50/50 solution of vinegar and water. Follow by rinsing the area with clean water; dry and polish with a soft cloth. Glass cleaners may be used if sprayed on a soft cloth first. Do not spray liquids directly on the oven control and display area.
Control panel	Do not use large amounts of water on the control panel - excess water on the control area may cause damage to the appliance. Do not use other liquid cleaners, abrasive cleaners, scouring pads, or paper towels - they will damage the finish.
Control knobs	To remove control knobs, turn to the OFF position; grasp firmly and pull straight off the shaft. To replace knobs after cleaning, line up the knob markings with the matching markings on the control panel; then push the knobs into place. On the single element knobs line up the OFF markings before replacing the knobs.
Stainless Steel	Your oven finish may be made with stainless steel (some models). Clean the stainless with warm soapy water using a clean sponge or cloth. Rinse with clean water and dry with a soft clean cloth. Do not use cleaners containing any abrasive, chlorides, chlorine, or ammonia. It is recommended to use mild dish soap and water or a 50/50 solution of water and vinegar.
Porcelain enamel broiler pan and insert (available by mail order) Oven interior (Porcelain) Door liner and body parts	Gentle scouring with a soapy scouring pad will remove most spots. Rinse with a 1:1 solution of clear water and ammonia. If necessary, cover difficult spots with an ammonia-soaked paper towel for 30 to 40 minutes. Rinse with clean water and a damp cloth, and then scrub with a soap-filled scouring pad. Rinse and wipe dry with a clean cloth. Remove all cleaners or the porcelain may become damaged during future heating.
Ceramic Cooktop	For special care instructions see "Cooktop Maintenance" on page 34 .
Oven racks	Oven racks must be removed from oven cavity. Clean by using a mild, abrasive cleaner following manufacturer's instructions. Rinse with clean water and dry.
Oven door	Use soap and water to thoroughly clean the top, sides, and front of the oven door. Rinse well. You may use a glass cleaner on the outside glass of the door. Do not immerse the door in water. Do not spray or allow water or the glass cleaner to enter the door vents. Do not use oven cleaners, cleaning powders, or any harsh abrasive cleaning materials on the outside of the oven door. Do not clean the oven door gasket. On self-clean models, the oven door gasket is made of a woven material which is essential for a good seal. Care should be taken not to rub, damage, or remove this gasket.

CARE AND CLEANING

Cooktop Maintenance

Consistent and proper cleaning is essential to maintaining your ceramic glass cooktop.

Prior to using your cooktop for the first time, apply a ceramic cooktop cleaning cream (available in most hardware, grocery and department stores) to the ceramic surface. Buff with a non-abrasive cloth or sponge. This will make cleaning easier when soiled from cooking. The special cooktop cleaning cream leaves a protective finish on the glass to help prevent scratches and abrasions.

Sliding aluminum or copper clad bottom pans on the cooktop can cause metal markings on the cooktop surface. These marks should be removed immediately after the cooktop has cooled using the cooktop cleaning cream. Metal marks can become permanent if not removed prior to future use.

Cookware (cast iron, metal, ceramic or glass) with rough bottoms can mark or scratch the cooktop surface.

Do not:

- Slide anything metal or glass across the cooktop.
- Use cookware with dirt or dirt build up on bottom; replace with clean cookware before using.
- Use your cooktop as a cutting board or work surface in the kitchen.
- Cook foods directly on the cooktop surface without a pan.
- Drop heavy or hard objects on the ceramic glass cooktop, they may cause it to crack.

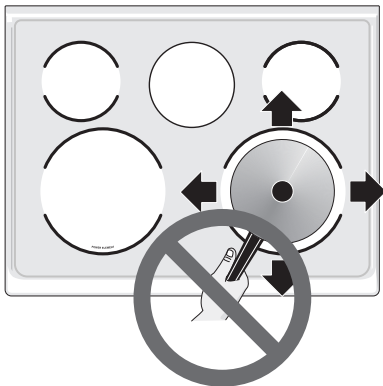

Figure 36: Cooktop care

Cooktop Cleaning

! WARNING

Do not use a cooktop cleaner on a hot cooktop. The fumes can be hazardous to your health, and can chemically damage the ceramic-glass surface.

! CAUTION

Before cleaning the cooktop, be sure the controls are turned to OFF and the cooktop is cool. The glass surface could be hot and burns may occur if the glass surface is touched before it has cooled sufficiently.

For light to moderate soil:

Apply a few drops of cooktop cleaning cream directly to the cooktop. Use a paper towel or use a non-abrasive cloth or sponge to clean the entire cooktop surface. Make sure the cooktop is cleaned thoroughly, leaving no residue.

For heavy, burned on soil:

Apply a few drops of cooktop cleaning cream directly to the soiled area. Rub the soiled area using a non-abrasive cleaning tool, applying pressure as needed. Do not use the pad you use to clean the cooktop for any other purpose.

If soils remain, carefully scrape soils with a metal razor blade scraper, holding scraper at a 30 degree angle to the surface. Remove loosened soils with cooktop cleaning cream and buff surface clean.

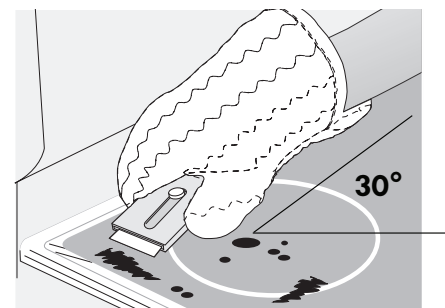

Figure 37: Cooktop cleaning

CARE AND CLEANING

Cooktop Maintenance (cont'd)

Plastic or foods with a high sugar content need be removed immediately if spilled or melted onto the ceramic cooktop surface. Permanent damage (such as pitting of the cooktop surface) may occur if not removed immediately. After turning the surface elements off, use a razor blade scraper or a metal spatula with a mitt and scrape the soil from the hot surface (as illustrated). Allow the cooktop to cool, and use the same method for heavy or burned on soils.

Do not use the following on the cooktop:

- Do not use abrasive cleaners and scouring pads, such as metal and some nylon pads. They may scratch the cooktop, making it more difficult to clean.
- Do not use harsh cleaners, such as chlorine bleach, ammonia or oven cleaners, as they may etch or discolor the cooktop.
- Do not use dirty sponges, cloths or paper towels, as they can leave soil or lint on the cooktop which can burn and cause discoloration.

→ IMPORTANT

Damage to the ceramic glass cooktop may occur if you use an abrasive type cleaning pad. Only use cleaning products that have been specifically designed for ceramic glass cooktops.



Figure 38: Cleaning products to avoid

General Cleaning

Refer to “[Cleaning Various Parts of Your Oven](#)” on [page 33](#) for more detailed information about cleaning specific parts of the range.

⚠ CAUTION

Before manually cleaning any part of the range, be sure all controls are turned off and the range is cool. The range may be hot and can cause burns.

⚠ CAUTION

Using ammonia to clean an oven is not recommended. However, if ammonia is used it must be rinsed thoroughly before operating the oven. Provide adequate ventilation.

Aluminum Foil and Utensils

⚠ WARNING

Never cover any slots, holes, or passages in the oven bottom or cover an entire oven rack with materials such as aluminum foil. Aluminum foil linings may trap heat, causing a fire hazard.

⚠ WARNING

Protective Liners — Do not use aluminum foil to line the oven bottom. Only use aluminum foil as recommended in this manual. Improper installation of these liners may result in risk of electric shock, or fire.

- Aluminum foil - Use of aluminum foil on a hot cooktop can damage the cooktop. Do not use thin aluminum cooking utensils or allow aluminum foil to touch the surface elements under any circumstances.
- Aluminum utensils - The melting point of aluminum is much lower than that of other metals. Care must be taken when aluminum pots or pans are used on the cooktop. If aluminum pans are allowed to boil dry when using the cooktop, not only will the utensil be damaged or destroyed, but it may fuse to, break, or mark the ceramic glass surface, permanently damaging the cooktop surface.

CARE AND CLEANING

Removing and Replacing the Oven Door

→ IMPORTANT

Special door care instructions - The door is heavy. For safe, temporary storage, lay the door flat with the inside of the door facing down.

Most oven doors contain glass that can break. Do not close the oven door until all the oven racks are positioned correctly in the cavity. Do not hit the glass with bakeware or any other objects. Scratching, hitting, jarring, or stressing the glass may weaken its structure, causing an increased risk of breakage at a later time.

To remove the oven door:

1. Open oven door completely, horizontal with floor.
2. Pull up the lock located on each hinge support toward front of the oven until the lock stops. You may have to apply a little upward pressure on the lock to pull it up (Figure 40 and Figure 41).
3. Grasp the door by the sides, and close the door until the door frame makes contact with the unlocked hinges.
4. Pull the bottom of the door toward you while rotating the top of the door toward the appliance to completely disengage the hinge levers (Figure 42).

To Replace Oven Door:

1. Firmly grasp both sides of oven door along the door sides. Do not use the oven door handle (Figure 42).
2. Hold the oven door at the same angle as the removal position. Carefully insert the hinge levers into the oven frame until you feel the hinge levers are seated into the hinge notches. The hinge arms must be fully seated into the hinge notches before the oven door can be fully opened. (Figure 42).
3. Fully open the oven door, horizontal with floor (Figure 39).
4. Push the door hinge locks up toward and into the oven frame on both left and right oven door hinges to the locked position (Figure 40).
5. Close the oven door.

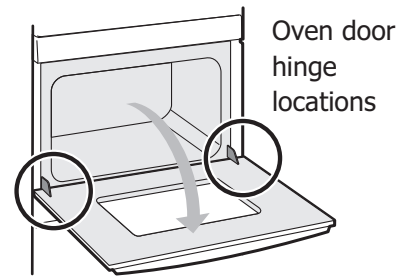

Figure 39: Door hinge location

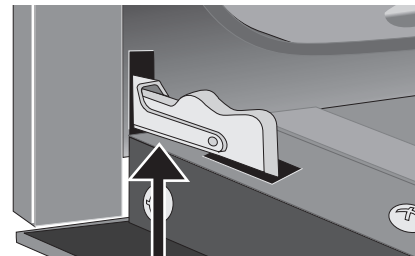

Figure 40: Door hinge locked

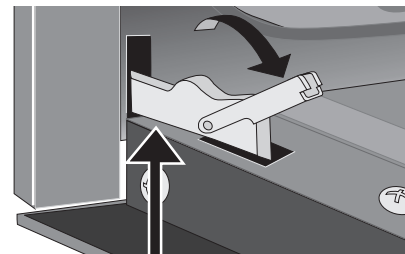

Figure 41: Unlocking door hinge

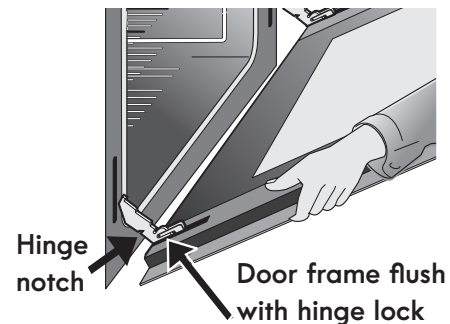

Figure 42: Remove door position

Replacing the Oven Lights

Replacing the oven interior light bulb:

CAUTION

Be sure the oven is unplugged and all parts are cool before replacing oven light.

Your oven is equipped with interior oven lights that ramp up gradually when the oven door is opened. The oven lights can also be turned on when the door is closed by using the oven light switch located on the control panel.

To remove and replace a light bulb:

Be sure the range is unplugged and all parts are cool before replacing oven light. Wear a leather-faced glove for protection against possible broken glass. Do not allow your fingers to touch the new bulb when replacing. Use a clean soft cloth or paper towel to cover the new bulb when installing.

1. Turn electrical power off at the main source or unplug the appliance.
2. To remove the glass shield, pull the back side of the shield toward the inside of the oven in a manner to lift it up from the oven side. The glass shield should come out easily by pushing a little toward front of the wall oven (Figure 43).
3. Replace the halogen appliance bulb.
4. Gently push the glass shield toward the oven wall until it is firmly seated against the oven wall.
5. Reconnect electrical power to the appliance or turn power back on.

Lift backside of glass shield and remove it.

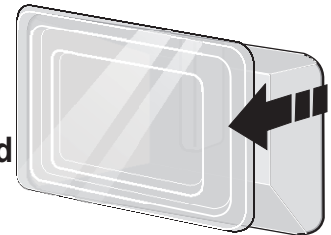

Halogen Light Bulb

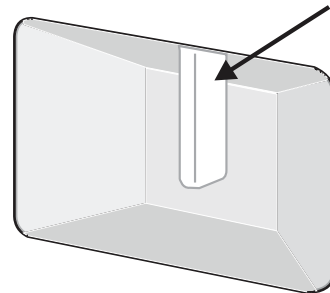

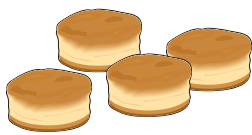



Figure 43: Light shield and bulb

BEFORE YOU CALL

Solutions to Common Baking Problems

For best cooking results, heat the oven before baking cookies, breads, cakes, pies or pastries, etc. There is no need to preheat the oven for roasting meat or baking casseroles. The cooking times and temperatures needed to bake a product may vary slightly from your previously owned appliance.

Baking Problems and Solutions Chart

Baking Problems	Causes	Corrections
Cookies and biscuits burn on the bottom. 	<ul style="list-style-type: none"> • Cookies and biscuits put into oven before the preheating time is completed. • Oven rack is overcrowded. • Dark pans absorb heat too fast. 	<ul style="list-style-type: none"> • Allow oven to preheat to desired temperature before placing food in oven. • Choose pan sizes that will permit 2" to 4" of air space (5.1 cm to 10.2 cm) on all sides when placed in the oven. • Use a medium weight baking sheet.
Cakes too dark on top or bottom. 	<ul style="list-style-type: none"> • Cakes put in oven before preheating time is completed. • Rack position too high or too low. • Oven too hot. 	<ul style="list-style-type: none"> • Allow oven to preheat to the selected temperature before placing food in the oven. • Use proper rack position for baking needs. • Set oven temperature 25°F/13°C lower than recommended.
Cakes not done in center. 	<ul style="list-style-type: none"> • Oven too hot. • Incorrect pan size. • Pan not centered in oven. 	<ul style="list-style-type: none"> • Set oven temperature 25°F/13°C lower than recommended. • Use pan size suggested in recipe. • Use proper rack position and place pan to allow for 2" to 4" (5.1 cm to 10.2 cm) of space on all sides of pan.
Cakes not level. 	<ul style="list-style-type: none"> • Range not level. • Pan too close to oven wall or rack overcrowded. • Pan warped. • Oven light left on during baking. 	<ul style="list-style-type: none"> • Place a marked glass measuring cup filled with water on the center of the oven rack. If the water level is uneven, refer to the installation instructions for leveling the range. • Be sure to allow 2" to 4" (5.1 cm to 10.2 cm) of clearance on all sides of each pan in the oven. • Do not use pans that are dented or warped. • Keep oven light off while baking.
Foods not done when cooking time is over. 	<ul style="list-style-type: none"> • Oven too cool. • Oven overcrowded. • Oven door opened too frequently. 	<ul style="list-style-type: none"> • Set oven temperature 25°F/13°C higher than suggested and bake for the recommended time. • Be sure to remove all pans from the oven except the ones to be used for baking. • Open oven door only after shortest recommended baking time.

Solutions to Common Problems

Before you call for service, review the following list. It may save you time and expense. Possible solutions are provided with the problem listed:

Problem	Solution
Poor baking results	<ul style="list-style-type: none"> Many factors effect baking results. Use proper oven rack position. Center food in the oven and space pans to allow air to circulate. Preheat oven to the set temperature before placing food in the oven. Try adjusting the recipe's recommended temperature or baking time. See "Adjusting Oven Temperatures" on page 30 if you feel the oven is too hot or cold.
Long preheat	<ul style="list-style-type: none"> Your oven is larger than most conventional ovens and may take a few minutes longer to reach optimal cooking temperatures. Make sure you follow the suggestions at "Quick Preheat" on page 19.
Appliance is not level	<ul style="list-style-type: none"> Be sure floor is level, strong and stable enough to adequately support range. If floor is sagging or sloping, contact a carpenter to correct the situation. Poor installation. Place oven rack in center of oven and place a level on the oven rack. Adjust leveling legs at base of appliance until the rack is level. Kitchen cabinet alignment may make range appear not level. Be sure cabinets are square and have sufficient room for appliance clearance.
Cannot move appliance easily. Appliance must be accessible for service.	<ul style="list-style-type: none"> Cabinets not square or are built in too tight to allow clearance for appliance. Contact builder or installer to make appliance accessible. Carpet interferes with appliance. Provide sufficient space so appliance can be lifted over carpet.
Entire appliance does not work.	<ul style="list-style-type: none"> For models with a power cord, make sure power cord is plugged properly into outlet. If electricity to home is working, check fuse box or breaker. Call your local electric company for service outage information..
Surface element is too hot or not hot enough.	<ul style="list-style-type: none"> Incorrect surface control setting. Adjust power level setting.
Surface element does not heat or does not heat evenly.	<ul style="list-style-type: none"> Be sure the correct surface control knob is turned on for element needed. Lightweight or warped pans used. Use only flat, evenly balanced, medium or heavyweight cookware. Flat pans heat better than warped pans. Cookware materials and weight of the material affect heating. Heavy and medium-weight pans heat evenly. Because lightweight pans heat unevenly, foods may burn easily.
Oven portion does not operate.	<ul style="list-style-type: none"> The time of day is not set. The oven clock must first be set in order to operate the oven. See "Setting the Clock" on page 17. Be sure oven controls are set properly. See "Oven Control Functions" on page 14 and review instructions for the desired cooking function in this manual or see "Entire appliance does not operate" in this checklist.
Oven light does not work.	<ul style="list-style-type: none"> Be sure the oven light is secure in the socket. See "Replacing the Oven Lights" on page 37.
Flames inside oven or smoking from oven vent.	<ul style="list-style-type: none"> Excessive spills in oven. Grease or food spilled onto oven bottom or oven cavity. Wipe up excessive spills before starting oven. If flames or excessive smoke are present when using Broil, see "Broil" on page 25.

BEFORE YOU CALL

Oven racks discolored or do not slide easily.	<ul style="list-style-type: none">• Oven racks left in oven cavity during Clean. Always remove oven racks from oven cavity before starting a clean cycle. Clean by using a mild abrasive cleaner following manufacturer's instructions. Rinse with clean water, dry, and replace in oven.
Oven smokes excessively when broiling.	<ul style="list-style-type: none">• Incorrect setting. Follow broiling instructions in Setting Oven Controls section.• Meat too close to the broil element. Reposition broil rack to provide proper clearance between the meat and element. Remove excess fat from meat. Cut remaining fatty edges to prevent curling, but do not cut into lean.• Grease build up on oven surfaces. Regular cleaning is necessary when broiling frequently. Grease or food splatters will cause excessive smoking.
Oven control panel sounds an audible alarm and displays an Error code.	<ul style="list-style-type: none">• Oven control has detected a fault or error condition. Turn either oven mode or temperature selector to the OFF position to clear the error code. Try Bake or Broil function. If the Error code error repeats, turn OFF power to appliance, wait 5 minutes and then repower appliance. Set clock with correct time of day. Try Bake or Broil function again. If fault recurs, turn oven mode and temperature selectors OFF and call a servicer for assistance.
Soil not completely removed after Clean	<ul style="list-style-type: none">• Clean was interrupted. Review instructions in Clean section.• Excessive spills on oven bottom. Clean before starting Clean.• Failure to clean soil from the oven frame, the door liner outside the oven door gasket and the small area at the front center of the oven bottom. These areas are not in the self-cleaning area, but get hot enough to burn on residue. Clean these areas before starting the clean cycle. Burned-on residue can be cleaned with a stiff nylon brush and water or a nylon scrubber. Be careful not to damage the oven gasket.
Fan noise occurring after the oven is turned off.	<ul style="list-style-type: none">• Some models are equipped with a cooling fan that runs during the cooking process to cool internal electronic components. It is normal for this fan to continue to run for an extended period of time, even when the oven is off.
Convection fan does not rotate.	<ul style="list-style-type: none">• Oven door is open. Convection fan will turn off if oven door is opened when Convection is active. Close oven door.
Clean does not work.	<ul style="list-style-type: none">• Oven control not set properly. Review instructions in Clean section.
Scratches or abrasions on cooktop surface.	<ul style="list-style-type: none">• Coarse particles such as salt or hardened soils between cooktop and utensils can cause scratches. Be sure cooktop surface and bottoms of utensils are clean before usage. Small scratches do not affect cooking and will become less visible with time.• Cleaning materials not recommended for ceramic-glass cooktop have been used. Apply a ceramic cooktop cleaning cream to the ceramic surface. Buff with a non-abrasive cloth or sponge.• Cookware with rough bottom was used. Use smooth, flat-bottomed cookware.

WARRANTY

Your appliance is covered by a one year limited warranty. For one year from your original date of purchase, Electrolux will pay all costs for repairing or replacing any parts of this appliance that prove to be defective in materials or workmanship when such appliance is installed, used and maintained in accordance with the provided instructions.

Exclusions

This warranty does not cover the following:

1. Products with original serial numbers that have been removed, altered or cannot be readily determined.
2. Product that has been transferred from its original owner to another party or removed outside the USA or Canada.
3. Rust on the interior or exterior of the unit.
4. Products purchased "as-is" are not covered by this warranty.
5. Food loss due to any refrigerator or freezer failures.
6. Products used in a commercial setting.
7. Service calls which do not involve malfunction or defects in materials or workmanship, or for appliances not in ordinary household use or used other than in accordance with the provided instructions.
8. Service calls to correct the installation of your appliance or to instruct you how to use your appliance.
9. Expenses for making the appliance accessible for servicing, such as removal of trim, cupboards, shelves, etc., which are not a part of the appliance when it is shipped from the factory.
10. Service calls to repair or replace appliance light bulbs, air filters, water filters, other consumables, or knobs, handles, or other cosmetic parts.
11. Surcharges including, but not limited to, any after hour, weekend, or holiday service calls, tolls, ferry trip charges, or mileage expense for service calls to remote areas, including the state of Alaska.
12. Damages to the finish of appliance or home incurred during installation, including but not limited to floors, cabinets, walls, etc.
13. Damages caused by: services performed by unauthorized service companies; use of parts other than genuine Electrolux parts or parts obtained from persons other than authorized service companies; or external causes such as abuse, misuse, inadequate power supply, accidents, fires, or acts of God.

DISCLAIMER OF IMPLIED WARRANTIES; LIMITATION OF REMEDIES

CUSTOMER'S SOLE AND EXCLUSIVE REMEDY UNDER THIS LIMITED WARRANTY SHALL BE PRODUCT REPAIR OR REPLACEMENT AS PROVIDED HEREIN. CLAIMS BASED ON IMPLIED WARRANTIES, INCLUDING WARRANTIES OF MERCHANTABILITY OR FITNESS FOR A PARTICULAR PURPOSE, ARE LIMITED TO ONE YEAR OR THE SHORTEST PERIOD ALLOWED BY LAW, BUT NOT LESS THAN ONE YEAR. ELECTROLUX SHALL NOT BE LIABLE FOR CONSEQUENTIAL OR INCIDENTAL DAMAGES SUCH AS PROPERTY DAMAGE AND INCIDENTAL EXPENSES RESULTING FROM ANY BREACH OF THIS WRITTEN LIMITED WARRANTY OR ANY IMPLIED WARRANTY. SOME STATES AND PROVINCES DO NOT ALLOW THE EXCLUSION OR LIMITATION OF INCIDENTAL OR CONSEQUENTIAL DAMAGES, OR LIMITATIONS ON THE DURATION OF IMPLIED WARRANTIES, SO THESE LIMITATIONS OR EXCLUSIONS MAY NOT APPLY TO YOU. THIS WRITTEN WARRANTY GIVES YOU SPECIFIC LEGAL RIGHTS. YOU MAY ALSO HAVE OTHER RIGHTS THAT VARY FROM STATE TO STATE.

If You Need Service

Keep your receipt, delivery slip, or some other appropriate payment record to establish the warranty period should service be required. If service is performed, it is in your best interest to obtain and keep all receipts. Service under this warranty must be obtained by contacting Electrolux at the addresses or phone numbers below.

This warranty only applies in the USA and Canada. In the USA, your appliance is warranted by Electrolux Major Appliances North America, a division of Electrolux Home Products, Inc. In Canada, your appliance is warranted by Electrolux Canada Corp. Electrolux authorizes no person to change or add to any obligations under this warranty. Obligations for service and parts under this warranty must be performed by Electrolux or an authorized service company. Product features or specifications as described or illustrated are subject to change without notice.

USA
1.800.944.9044
Electrolux Home Products, Inc.
10200 David Taylor Drive
Charlotte, NC 28262



Canada
1.800.265.8352
Electrolux Canada Corp.
5855 Terry Fox Way
Mississauga, Ontario, Canada
L5V 3E4