

CMBE Booster

Horizontal, multistage centrifugal boosters

Description

50/60 Hz



WATER QUALITY

Drinking Water System Component
NSF / ANSI 61
NSF / ANSI 372



1. Product description	3
Product range	3
Applications	3
Approvals	3
Pumped liquids	3
Identification	4
Installation	5
Selection guide	6
2. Constant Pressure Booster	8
CMBE Booster Applications	8
Motor	8
Features	8
Operating conditions	8
Electrical data	8
Wetted parts	9
Dimensional drawings	9
Materials	10
Control panel	10
3. Performance curves	11
CMBE Booster 1-44 (115 V)	12
CMBE Booster 1-44	13
CMBE Booster 1-75 (115 V)	14
CMBE Booster 1-75	15
CMBE Booster 1-99	16
CMBE Booster 3-30 (115 V)	17
CMBE Booster 3-30	18
CMBE 3-51 (115 V)	19
CMBE 3-62	20
CMBE 3-93	21
CMBE 5-31	22
CMBE 5-62	23
CMBE 10-54	24
4. Grundfos Product Center	25
Grundfos GO	26

1. Product description

The compact Grundfos CMBE Booster is suitable for domestic applications such as raw-water supply, pressure boosting, irrigation and dewatering. The booster ensures a constant supply of fresh water to your home and garden.

Product range

CMBE



TM05 7512 3713

Fig. 1 CMBE

Applications

The boosters are designed to cover a wide range of applications from small domestic installations to small industrial systems. Typical applications:

- pressure boosting for home and gardening
- water supply for agriculture
- transfer and pressure boosting in break tank and rainwater applications
- water supply from shallow wells.

Approvals

Drinking Water Certifications:



TM06 3626 0215

UL Electrical:

1 x 230 V CMBE models: UL Listed Packaged Pumping System



TM06 3627 0215

UL Electrical:

1 x 115 V CMBE models: Motor is UL Recognized



TM06 4295 0515

Pumped liquids

The boosters are suitable for pumping clean, thin, non-aggressive and non-explosive liquids without solid particles or fibers. Examples:

- drinking or tap water
- rainwater and condensate
- groundwater
- river and lake water
- boiler feed water and district heating water
- chlorinated water
- softened water.

The pumps must not be used for transfer of diesel oil or other oil-containing liquids. Sand and other impurities in water can cause wear to the pump.

Identification

Type key

Example	CMBE	1	- 47	- I	- A	2	- E	- D	- E
Type range CMBE: CME Booster with integrated frequency converter									
Rated flow rate [m ³ /h]									
Max. head [m]									
Materials in contact with the pumped liquid									
I: Sleeve									
Pump shaft									
Impellers/chambers									
Pressure Manager									
Pressure tank									
5-way valve									
Supply voltage									
X: 1 x 115 V, 60 Hz									
U: 1 x 200-240 V, 60 Hz									
Motor									
C: High-efficiency motor with frequency converter (IP55)									
Mains cable and plug									
B: U.S. plug NEMA 5-15 (1 x 115 V m, 60 Hz, CMBE)									
I: Without cable and plug, (1 x 200 - 240 V, 60 Hz CMBE)									
Controller									
D: Integrated frequency converter									
Thread									
E: NPT 1"									
F: NPT 1 1/4"									
G: NPT 1 1/2"									
H: NPT 2"									

¹⁾ The new-generation MLE, currently 1/2 to 2 Hp (0.37 to 2.2 kW).

Note: The type key cannot be used for ordering as not all combinations are possible.

Installation

Mechanical installation

Placing the pump above ground is generally a convenient way of establishing a water or rainwater supply.

Place the pump as close as possible to the water supply to make the suction pipe as short as possible.

If a hose is used as suction pipe, it must be non-collapsible. Fit a strainer to the suction pipe to prevent solids from entering the pump.

The pump must be installed on a plane surface and fixed so that it cannot be displaced during startup and operation. The inlet direction must be horizontal.

The pump should be installed with easy access for inspection, maintenance and service.

The pump should be installed in a well-ventilated location.

Suction pipe

If the pump is to pump water from a well, borehole or similar, always fit a non-return valve on the suction pipe of the pump.

Install the suction pipe in such way that bends, air pockets and any unnecessary restrictions to the flow are avoided. See fig. 2.

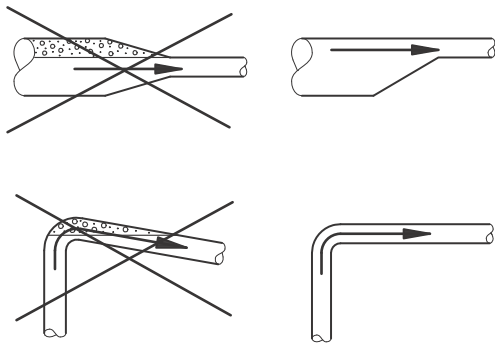

Fig. 2 Pipework recommendations

Long suction pipes affect the performance of the pump. The diameter of the suction pipe must not be smaller than that of the suction port. When the suction pipe is longer than 32 ft. (10 meters) or the suction lift is greater than 13 ft. (4 meters), the diameter of the suction pipe must be larger than that of the suction port.

The time from when the pump is started until it delivers water depends on the length of the suction pipe and on the suction lift. Do not allow the pump to run for more than five minutes before it delivers water as the heat generated will damage the pump.

Operating conditions

The maximum time of operation against a closed discharge valve is limited by the liquid temperature which must not exceed +104 °F (+40 °C).

The maximum inlet pressure depends on the pump head at the actual duty point. The sum of the inlet pressure and the pump head must not exceed the maximum system pressure.

Electrical installation

The electrical connection and protection should be carried out in accordance with local regulations.

- One-phase standard pumps incorporate thermal protection and therefore require no external protection.
- One-phase CMBE pumps require no external motor protection. The variable-speed motor incorporates thermal protection against slow overloading and blocking.

The electrical installation of the pressure control unit must be carried out so that the enclosure class is maintained.

Selection guide

This is a quick and easy tool to show you which product is ideal for your needs. Just follow the charts and instructions on this page, and you will be sure to get a perfect fit.

Example: sizing and selection

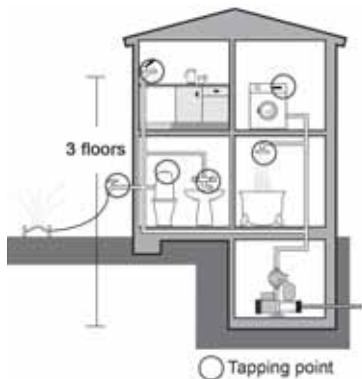

TM064160 0415

- A: Required comfort level**
- Adjustable constant pressure.
- B: Find the right booster**
- How many taps? 6.
 - How many floors? 3.
- Result: CMBE 1-75**

		Number of taps			
		1-5	6-10	11-20	21-50
Number of floors	4	CMBE 1-75	CMBE 1-75	CMBE 3-62	CMBE 3-93
	3	CMBE 1-44	CMBE 1-75	CMBE 3-62	CMBE 3-62
	2	CMBE 1-44	CMBE 1-44	CMBE 3-62	CMBE 3-62
	1	CMBE 1-44	CMBE 1-44	CMBE 3-30	CMBE 3-62

Fig. 3 Sizing and selection

Booster sizing and selection

Variable speed control



- Adjustable constant pressure
- Dry-running protection
- Low-noise

CMBE Booster

		Number of taps			
		1-5	6-10	11-20	21-50
Number of floors	4	CMBE 1-75	CMBE 1-75	CMBE 3-62	CMBE 3-93
	3	CMBE 1-44	CMBE 1-75	CMBE 3-62	CMBE 3-62
	2	CMBE 1-44	CMBE 1-44	CMBE 3-62	CMBE 3-62
	1	CMBE 1-44	CMBE 1-44	CMBE 3-30	CMBE 3-62

		CMBE 1 x 115 V Input Power			
		Number of taps			
		1-5	6-10	11-20	21-50
Number of floors	4	CMBE 1-75	CMBE 1-75	–	–
	3	CMBE 1-44	CMBE 1-75	CMBE 3-51	–
	2	CMBE 1-44	CMBE 1-44	CMBE 3-51	CMBE 3-51
	1	CMBE 1-44	CMBE 1-44	CMBE 3-30	CMBE 3-51

		CMBE 1 x 230 V Input Power			
		Number of taps			
		1-5	6-10	11-20	21-50
Number of floors	4	CMBE 1-75	CMBE 1-75	CMBE 3-62	CMBE 3-93
	3	CMBE 1-44	CMBE 1-75	CMBE 3-62	CMBE 3-62
	2	CMBE 1-44	CMBE 1-44	CMBE 3-62	CMBE 3-62
	1	CMBE 1-44	CMBE 1-44	CMBE 3-30	CMBE 3-62

- Preconditions:**
- A tap pressure of 45 psi is considered, to achieve a pressure of 60 psi, add two floors.
 - Flooded suction: Add more floors to compensate for low suction pressure.
 - 7.9 gpm per tap average usage pattern is taken into account.
- Grundfos cannot be held responsible for wrong sizing based on this guide.

CMBE Selection Guides

1 x 115 V Supply Power Flow Rate Selection Chart

PSI Boost	0-10 GPM	0-15 GPM	0-20 GPM	0-25 GPM
20	CMBE 1-44	CMBE 1-44	CMBE 3-30	CMBE 3-30
25	CMBE 1-44	CMBE 1-44	CMBE 3-30	CMBE 3-30
30	CMBE 1-44	CMBE 1-44	CMBE 3-30	CMBE 3-51
35	CMBE 1-44	CMBE 1-75	CMBE 3-51	*CMBE 3-51
40	CMBE 1-44	CMBE 3-51	*CMBE 3-51	*CMBE 3-51
45	CMBE 1-44	CMBE 3-51	*CMBE 3-51	-
50	CMBE 1-44	CMBE 3-51	-	-
55	CMBE 1-75	*CMBE 3-51	-	-
60	CMBE 1-75	*CMBE 3-51	-	-
65	*CMBE 1-75	-	-	-
70	*CMBE 1-75	-	-	-
75	*CMBE 1-75	-	-	-
80	*CMBE 1-75	-	-	-

Note: (*) indicates pump may be 5-10% undersized on flow at desired pressure.

1 x 230 V Supply Power Flow Rate Selection Chart

PSI Boost	0-15 GPM	0-25 GPM	0-35 GPM	0-45 GPM	0-55 GPM	0-65 GPM	0-70 GPM
20	CMBE 1-44	CMBE 3-30	CMBE 5-31	CMBE 10-54	CMBE 10-54	CMBE 10-54	CMBE 10-54
25	CMBE 1-44	*CMBE 3-30	CMBE 5-31	CMBE 10-54	CMBE 10-54	CMBE 10-54	CMBE 10-54
30	CMBE 1-75	CMBE 5-31	CMBE 5-31	CMBE 10-54	CMBE 10-54	CMBE 10-54	*CMBE 10-54
35	CMBE 1-75	CMBE 3-62	CMBE 5-31	CMBE 10-54	CMBE 10-54	*CMBE 10-54	-
40	CMBE 1-75	CMBE 3-62	CMBE 5-62	CMBE 10-54	*CMBE 10-54	-	-
45	CMBE 1-75	CMBE 3-62	CMBE 5-62	*CMBE 10-54	-	-	-
50	CMBE 1-99	CMBE 3-62	CMBE 5-62	*CMBE 10-54	-	-	-
55	CMBE 1-99	CMBE 3-93	CMBE 5-62	-	-	-	-
60	CMBE 1-99	CMBE 3-93	CMBE 5-62	-	-	-	-
65	CMBE 1-99	CMBE 5-62	-	-	-	-	-
70	CMBE 3-93	CMBE 5-62	-	-	-	-	-
75	CMBE 3-93	CMBE 5-62	-	-	-	-	-
80	CMBE 3-93	CMBE 5-62	-	-	-	-	-

Note: (*) indicates pump may be 5-10% undersized on flow at desired pressure.

2. Constant Pressure Booster



TM05 7512 3713

Fig. 4 CMBE Booster

The compact Grundfos CMBE Booster is suitable for water supply in domestic applications. Thanks to the integrated speed controller, the booster keeps a constant pressure in the pipe system. A pressure sensor monitoring changes in the water consumption will signal to the speed controller to change the motor speed to adapt the performance to the new situation. The optional inlet pressure switch prevents the pump from operating in case of low inlet pressure.

The CMBE Booster consists of these components:

- CME pump with integrated frequency converter
- 5-way fitting with non-return valve
- diaphragm tank
- pressure gauge
- pressure sensor

CMBE Booster Applications

The CMBE Booster is mainly used for domestic and light commercial water supply or pressure boosting.

Application	CMBE 1	CMBE 3	CMBE 5	CMBE 10
Single-family houses	•	•	○	○
Two-family houses	○	•	•	•
Cluster homes		•	•	•
Blocks of flats		•	•	•
Schools		•	•	•
Small hotels/guest houses		•	•	•
Small office buildings		•	•	•
Agriculture		○	•	•
Irrigation		○	•	•

- Recommended
- Applicable.

Motor

No external motor protection is required. The MLE motor incorporates thermal protection against slow overloading and blocking (TP 211 according to IEC 34.11).

Features

- constant pressure via integrated speed control
- compact
- robust, stainless steel design
- easy installation
- low energy consumption
- dry-running protection
- noise level below 55 dBA and even lower at controlled speed

Operating conditions

System pressure	Max. 145 psi
Suction lift	Max. 23 ft. including suction-pipe pressure loss at a liquid temperature of 68 °F (+20 °C).
Liquid temperature	32 °F to 140 °F (0 °C to +60 °C).
Ambient temperature	Max. 113 °F (+45 °C) for 115V Max. 122 °F (+50 °C) for 220V Min. -4 °F (-20 °C).
Relative air humidity	Max. 95 %.
Enclosure class	IP55.
Insulation class	F.
Sound pressure level	The sound pressure level of the pump is below 55 dB(A).
Supply voltage	1 x 200-240 V, 1 x 115 V, 60 Hz
Start/stop frequency	Max. 100 per hour.
Cut-in pressure	7 psi below setpoint.

Electrical data

Pump type	Voltage [V]	I _{max} [A]	P1 [W]	Motor (Hp) Nominal
CMBE 1-44	1 x 115	8	1100	1
	1 x 200-240	3.4 - 2.9	685	1.5
CMBE 1-75	1 x 115	8	1100	1
	1 x 200-240	6.55 - 5.45	969	1.5
CMBE 1-99	1 x 200-240	6.55 - 5.45	1050	1.5
CMBE 3-30	1 x 115	8	1100	1
	1 x 200-240	6.55 - 5.45	815	1.5
CMBE 3-51	1 x 115	8	1100	1
CMBE 3-62	1 x 200-240	6.55 - 5.45	1220	1.5
CMBE 3-93	1 x 200-240	8.9 - 7.45	1300	2
CMBE 5-31	1 x 200-240	6.55 - 5.45	1300	1.5
CMBE 5-62	1 x 200-240	8.9 - 7.45	1400	2
CMBE 10-54	1 x 200-240	9.1 - 7.6	1250	2

Wetted parts

The table below specifies the parts of the pump that are in contact with the pumped liquid.

Designation	Material	Technical description
Pump sleeve	Stainless steel	AISI 304/ EN 1.4301
Impeller	Stainless steel	AISI 304/ EN 1.4301
Diffuser	Technopolymer	PP 20 % Talc
Ejector	Technopolymer	PPE/PS 20 % GF
Nozzle	Stainless steel	AISI 304/ EN 1.4301
Shaft	Stainless steel	AISI 304/ EN 1.4301
Shaft seal	Carbon with resin/ceramic	CVBP
Filling plug	Technopolymer	PES 30 % GF
Drain plug	Technopolymer	PES 30 % GF

Dimensional drawings

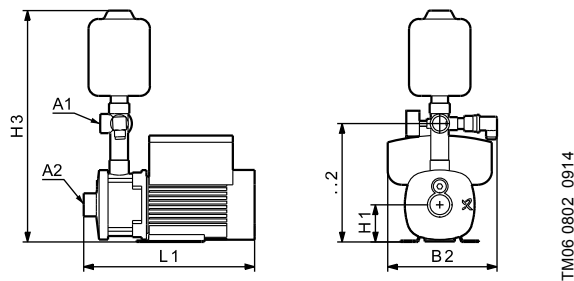

Pump type	H1 [in. (mm)]	H2 [in. (mm)]	H3 [in. (mm)]	L1 [in. (mm)]	B2 (L2) [in. (mm)]	A1 [NPT]	A2 [NPT]
CMBE 1-44	2.95 (75)	7.87 (200)	17.32 (440)	12.83 (326)	8.54 (217)	1"	1"
	17.32 (440)	7.87 (200)	2.95 (75)	12.83 (326)	8.54 (217)	1"	1"
CMBE 1-75	2.95 (75)	7.87 (200)	17.32 (440)	12.83 (326)	8.54 (217)	1"	1"
	17.32 (440)	7.87 (200)	2.95 (75)	14.25 (362)	8.54 (217)	1"	1"
CMBE 1-99	17.32 (440)	7.87 (200)	2.95 (75)	15.66 (398)	8.54 (217)	1"	1"
CMBE 3-30	2.95 (75)	7.87 (200)	17.32 (440)	12.83 (326)	8.54 (217)	1"	1"
	17.32 (440)	7.87 (200)	2.95 (75)	12.83 (326)	8.54 (217)	1"	1"
CMBE 3-51	2.95 (75)	7.87 (200)	17.32 (440)	12.83 (326)	8.54 (217)	1"	1"
CMBE 3-62	17.32 (440)	7.87 (200)	2.95 (75)	13.54 (344)	8.54 (217)	1"	1"
CMBE 3-93	17.91 (455)	8.46 (215)	3.54 (90)	15.90 (404)	8.54 (217)	1"	1"
CMBE 5-31	17.32 (440)	7.87 (200)	2.95 (75)	12.83 (326)	8.54 (217)	1"	1 1/4"
CMBE 5-62	17.91 (455)	8.46 (215)	3.54 (90)	13.77 (350)	8.54 (217)	1"	1 1/4"
CMBE 10-54	20.07 (510)	9.96 (253)	3.62 (92)	14.84 (377)	9.13 (232)	1 1/2"	1 1/2"

Materials

Designation	Material
Terminal box	Composite PC/ASA and silumin (Alu)
Stator housing	Silumin (Alu)
Fan cover	Composite PBT/PC
Pump housing	Stainless steel, AISI 304/EN 1.4301
Shaft and impeller	Stainless steel, AISI 304/EN 1.4301
Flange	Cast iron

Control panel

The control panel on the E-pump terminal box makes it possible to change the setpoint settings manually.

MLE 1/2 to 2 Hp (0.37 to 2.2 kW)

The operating condition of the pump is indicated by the Grundfos Eye on the control panel. See fig. 5, pos. A.

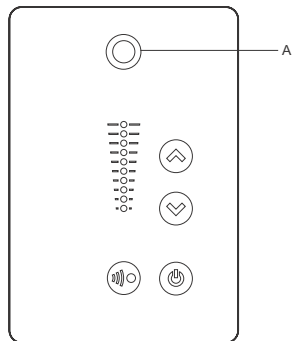

TM05 5993 4312

Fig. 5 Control panel on CRE pump

Set the desired setpoint by pressing ⬆ or ⬇. The light fields on the control panel will indicate the setpoint set. Continuously pressing ⬇ will stop the pump.

3. Performance curves

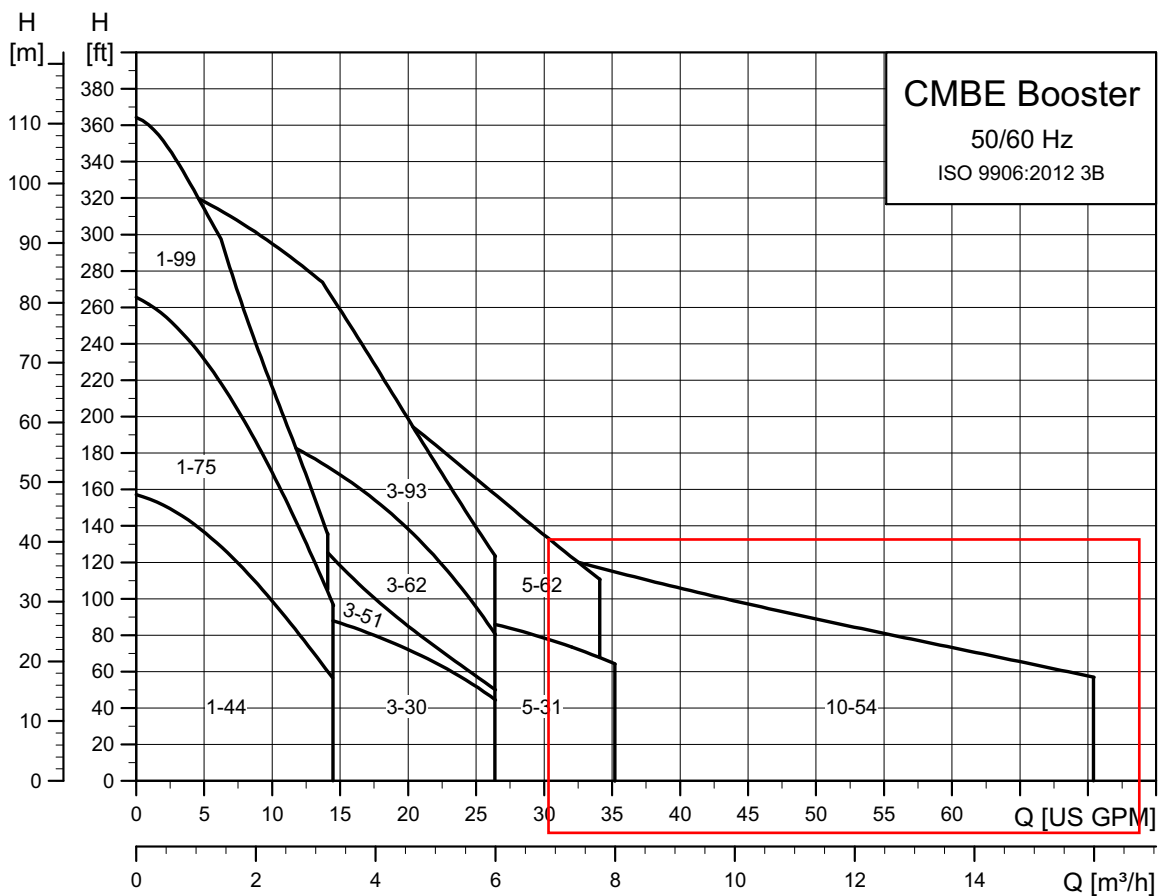

TM06 1420 0614

CMBE Booster 1-44 (115 V)

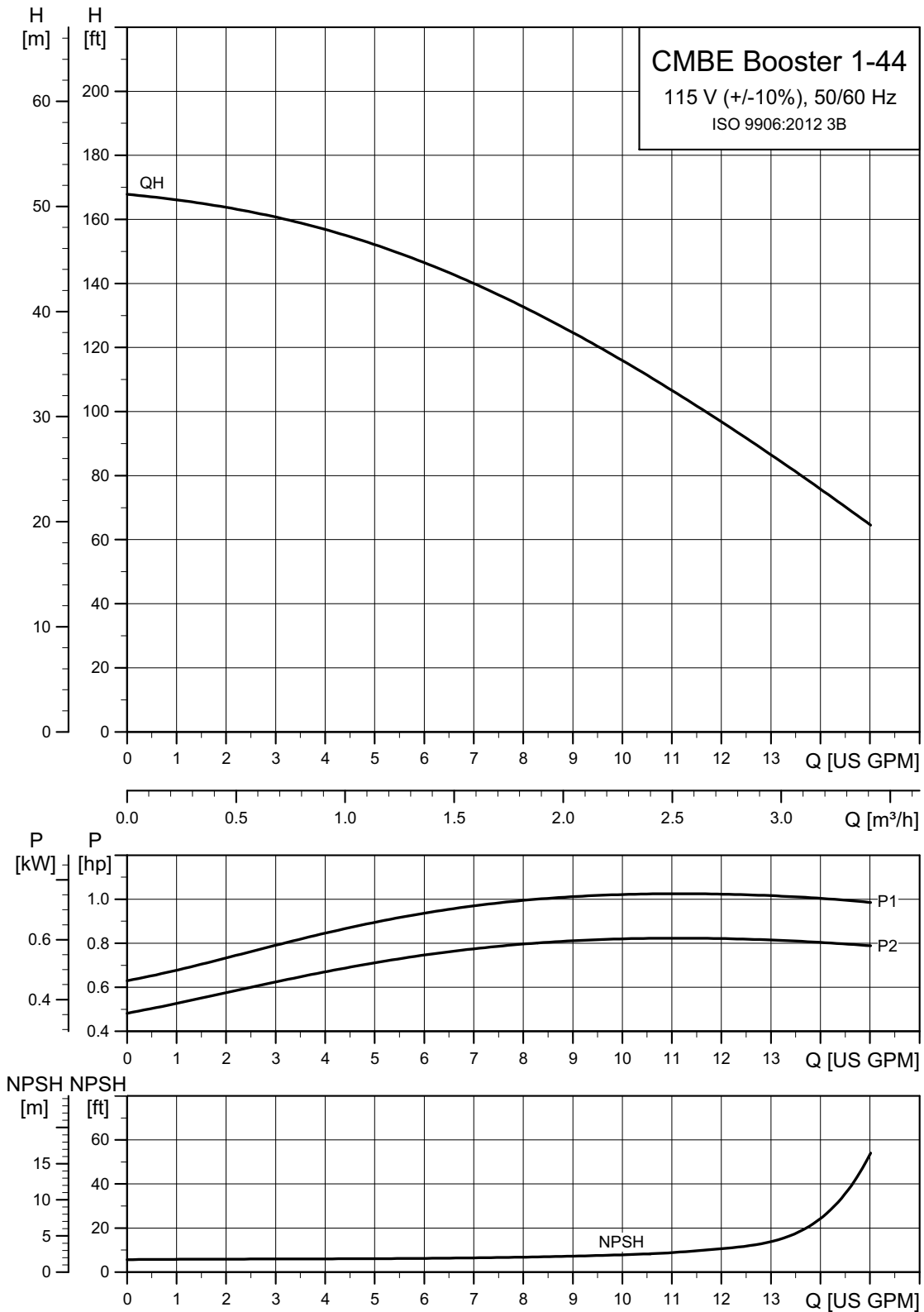

TM06 3401 0115

CMBE Booster 1-44

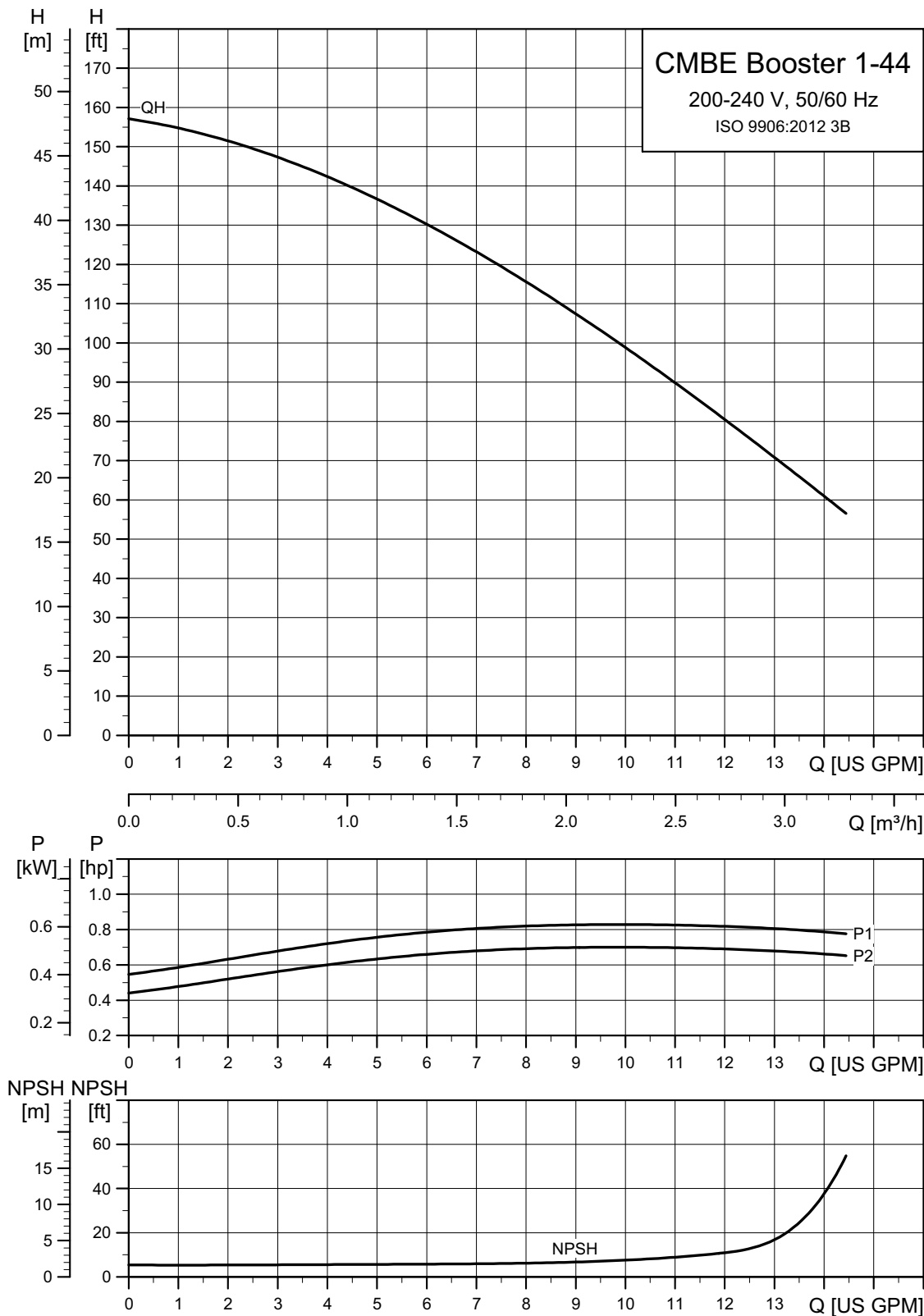

TM06 3391 0115

CMBE Booster 1-75 (115 V)

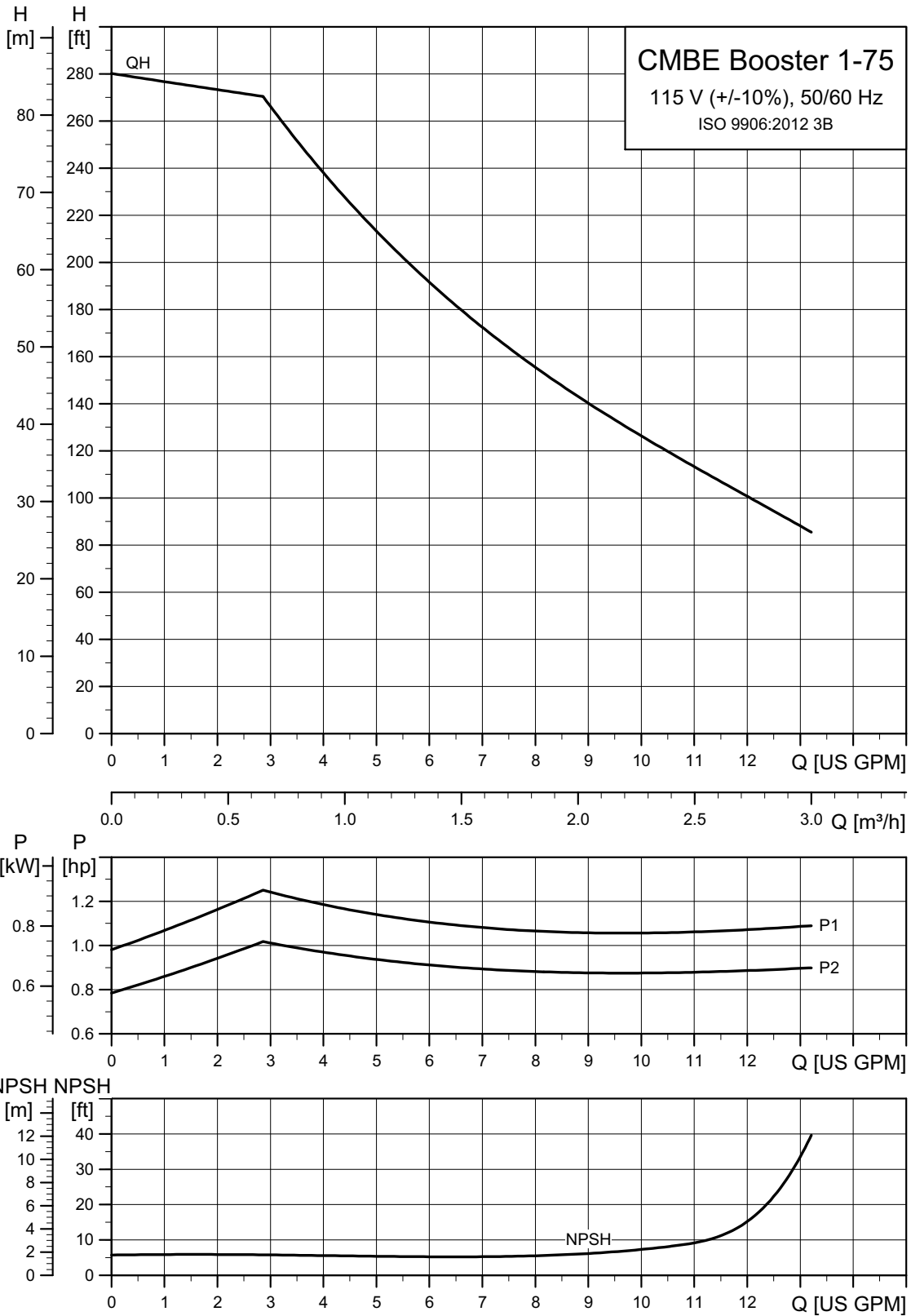

TM06 3402 0115

CMBE Booster 1-75

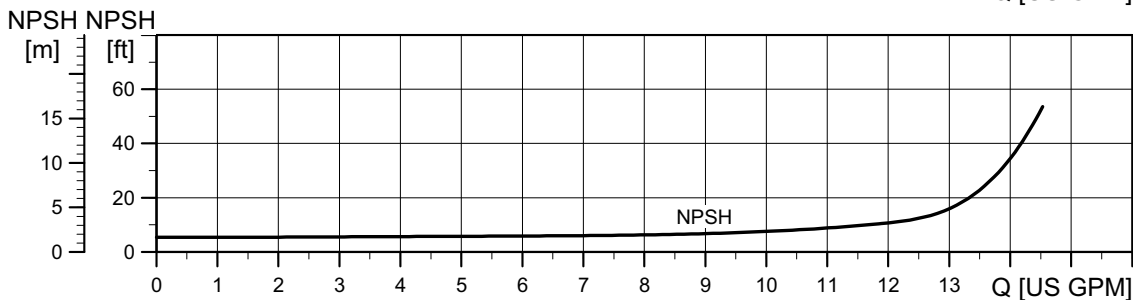
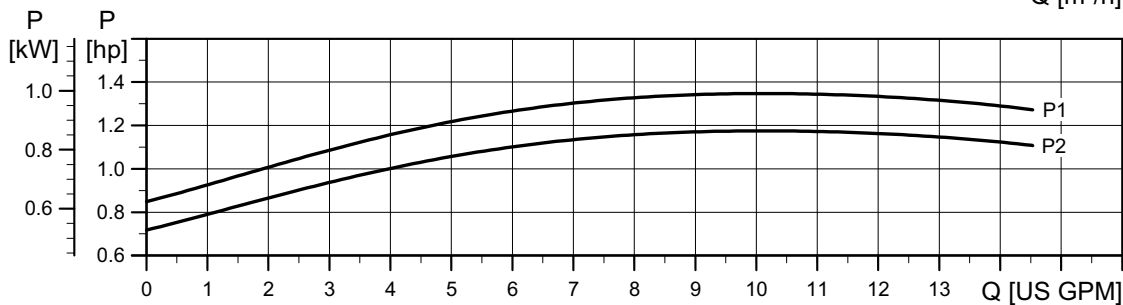
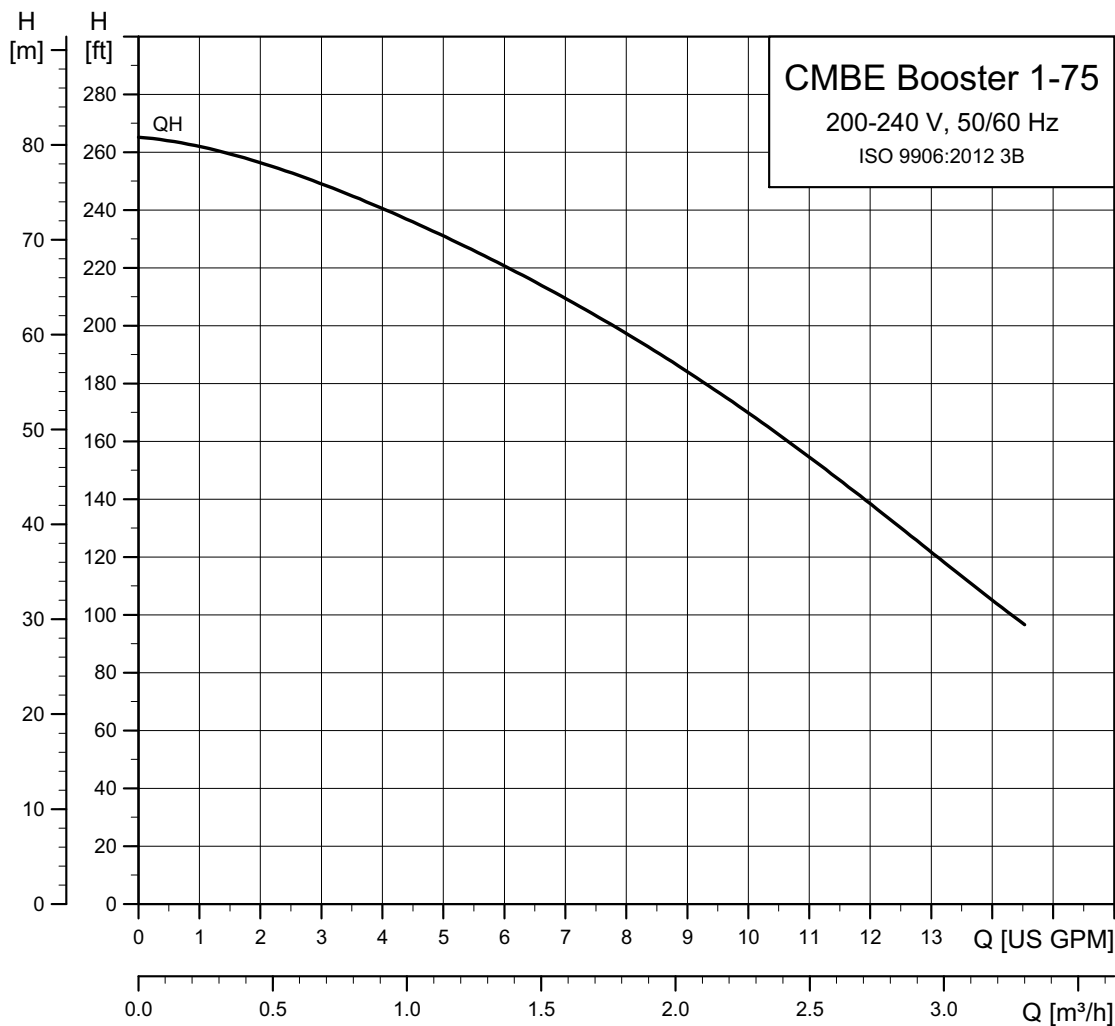

TM06 3392 0115

CMBE Booster 1-99

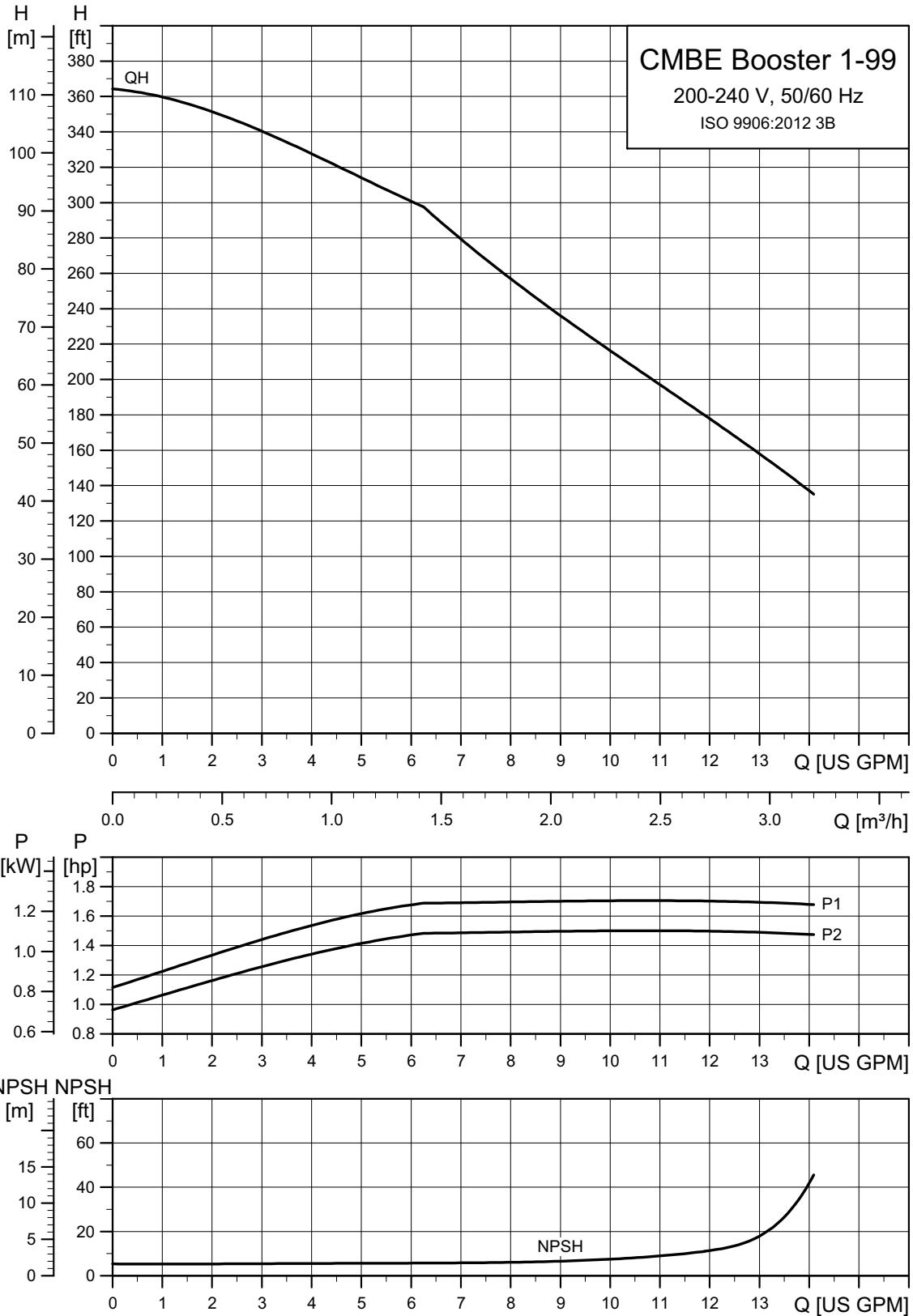

TM06 3393 0115

CMBE Booster 3-30 (115 V)

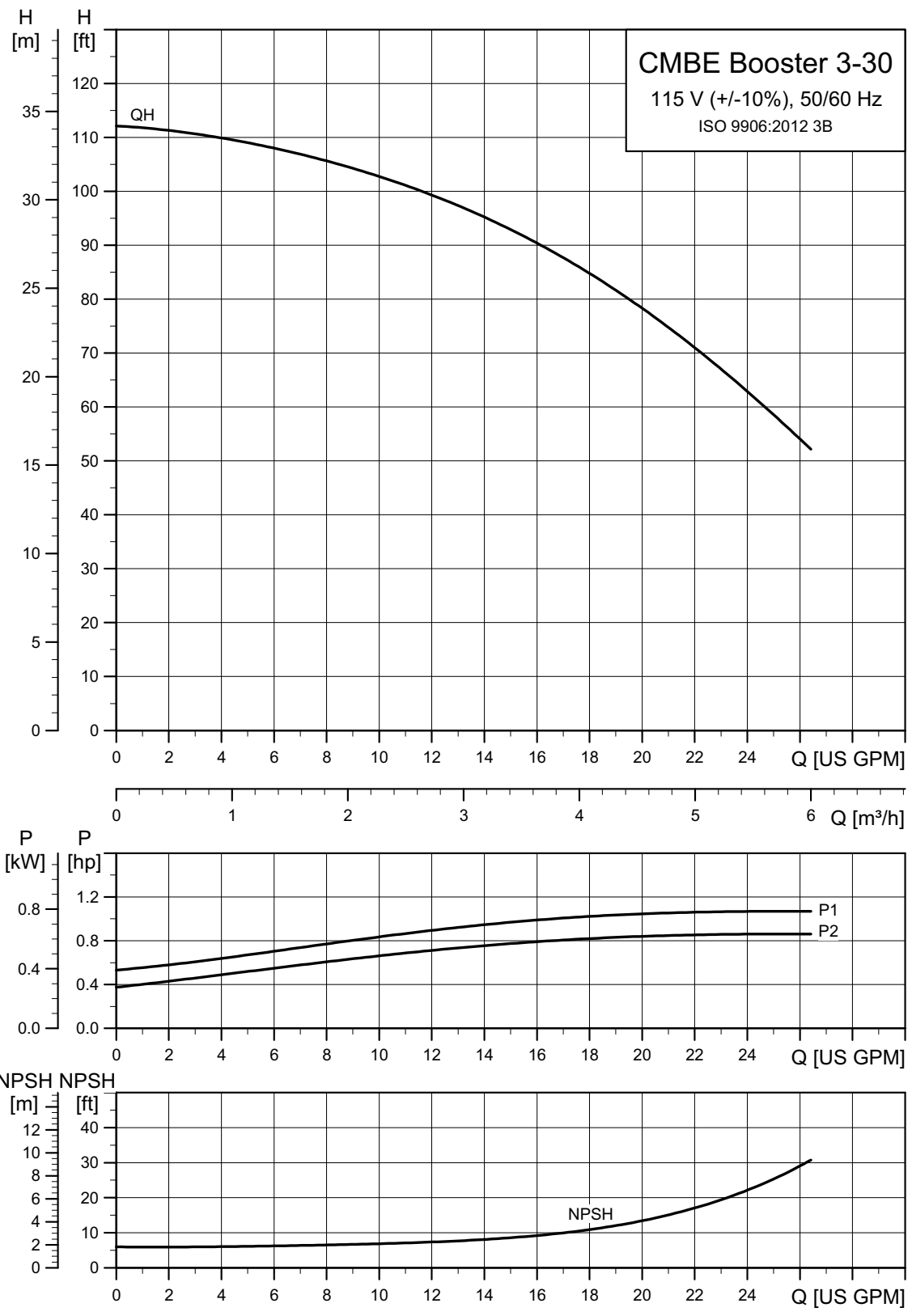

TM063403 0215

CMBE Booster 3-30

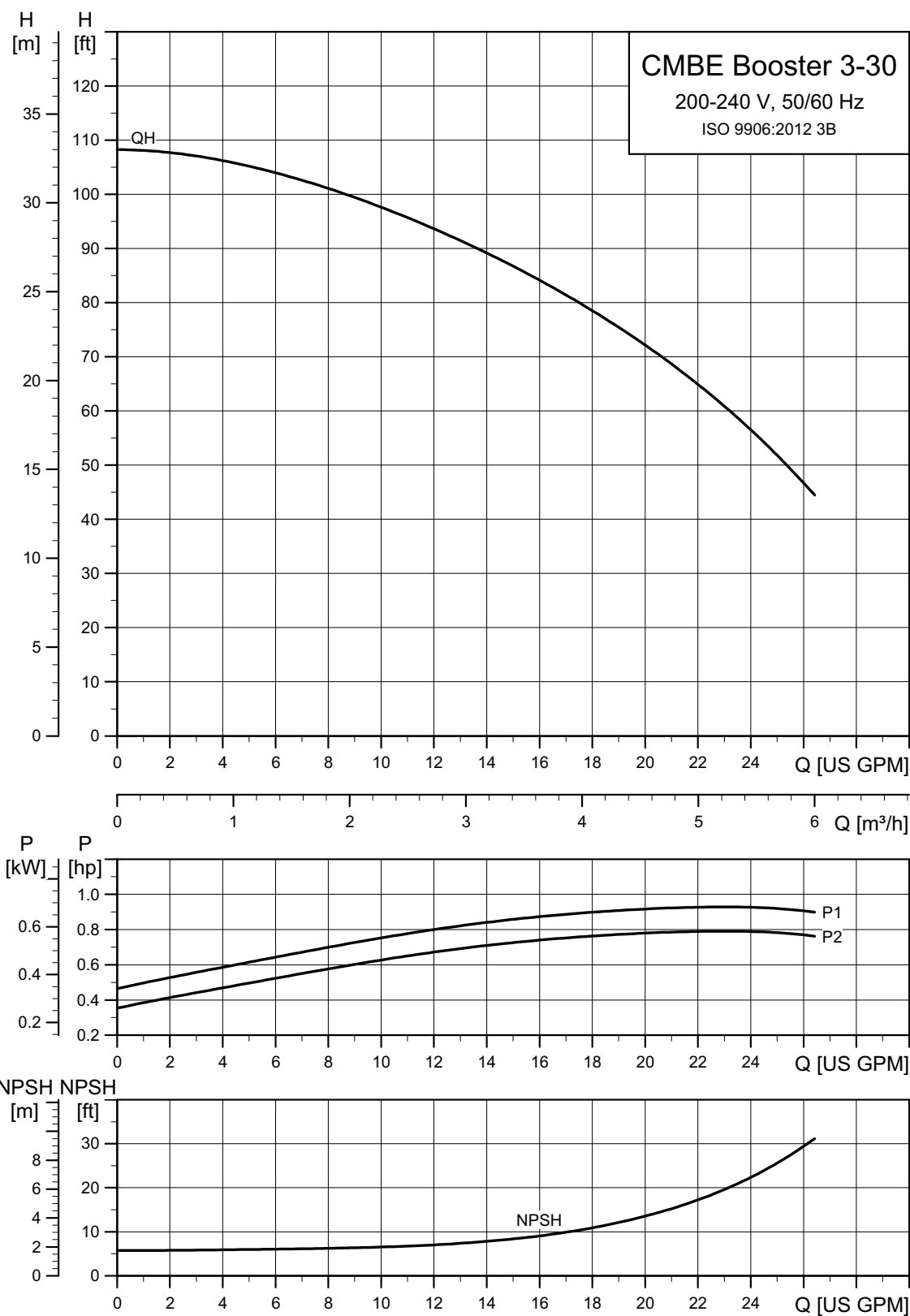

TM06 3394 0115

CMBE 3-51 (115 V)

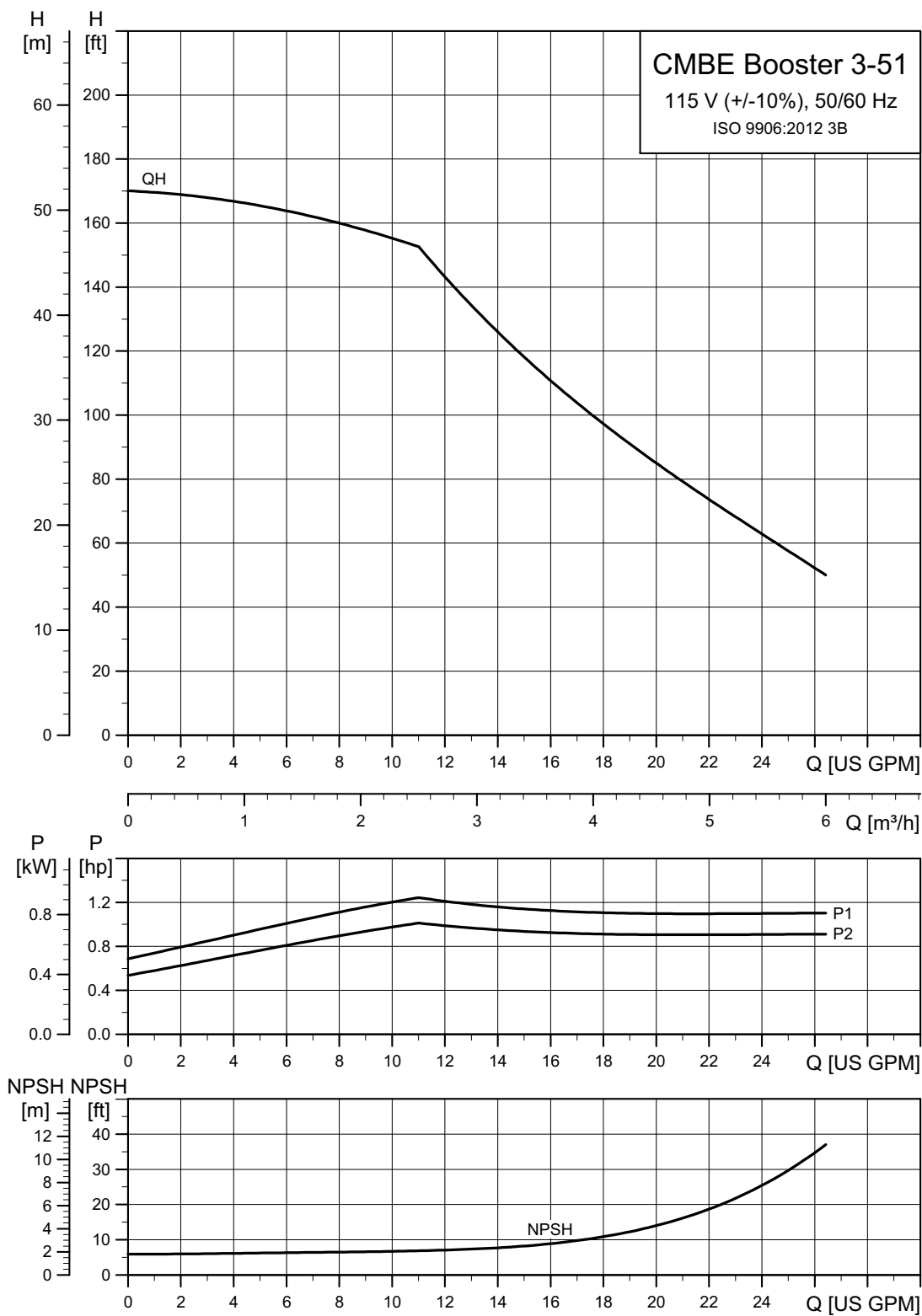

TM06 3404 0115

CMBE 3-62

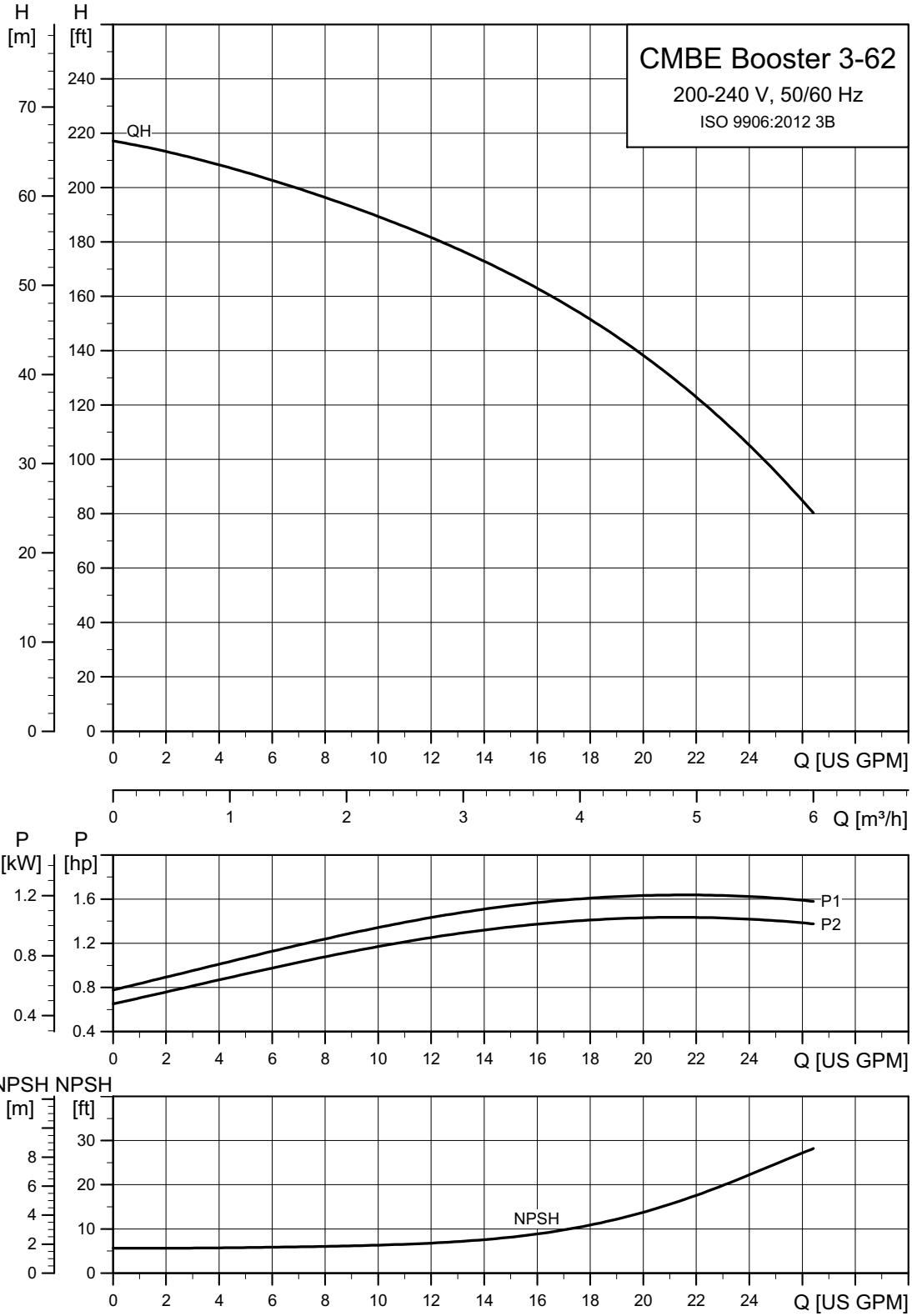

TM06 3395 0115

CMBE 3-93

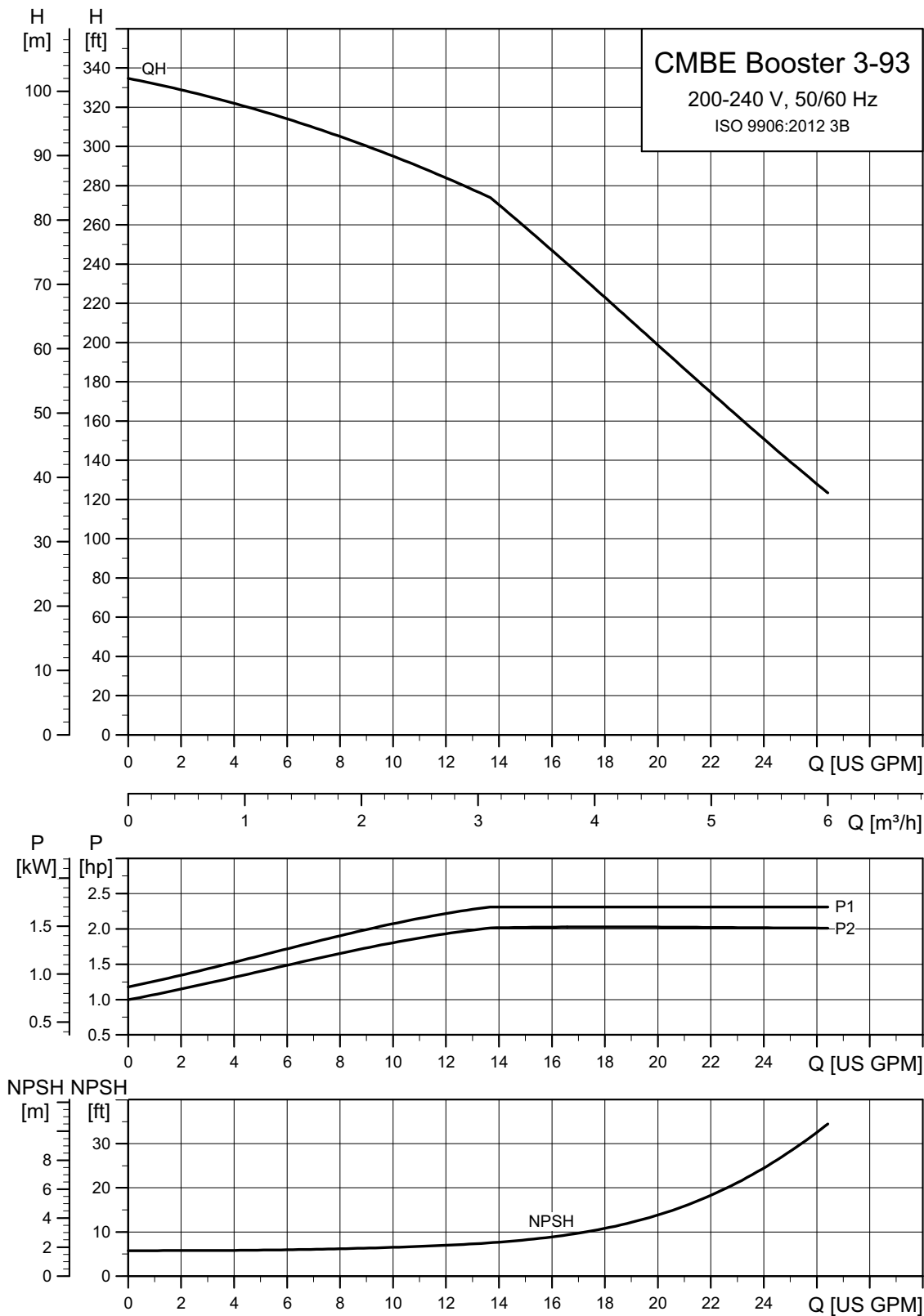

TM06 3396 0115

CMBE 5-31

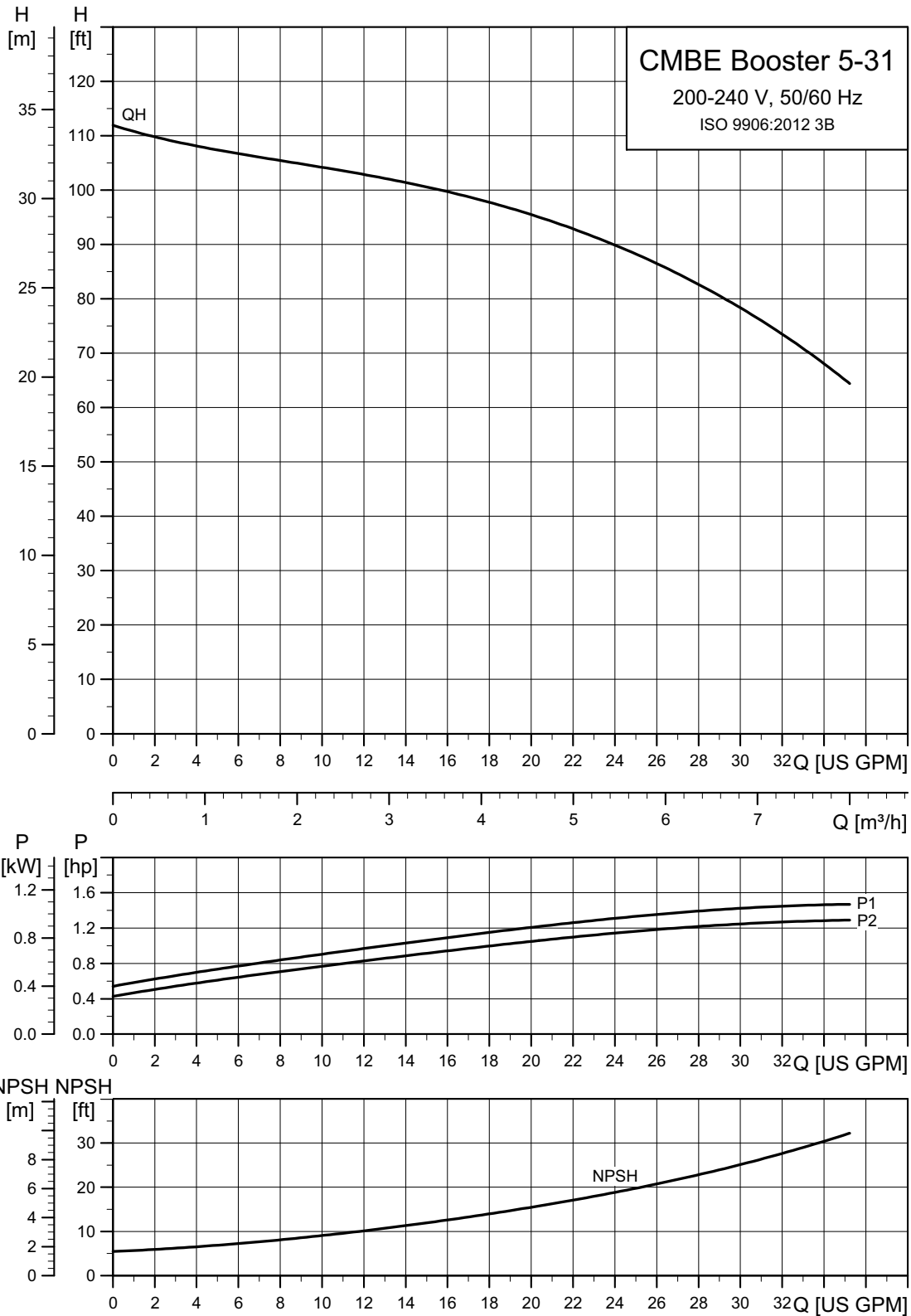

TM06 3397 0115

CMBE 5-62

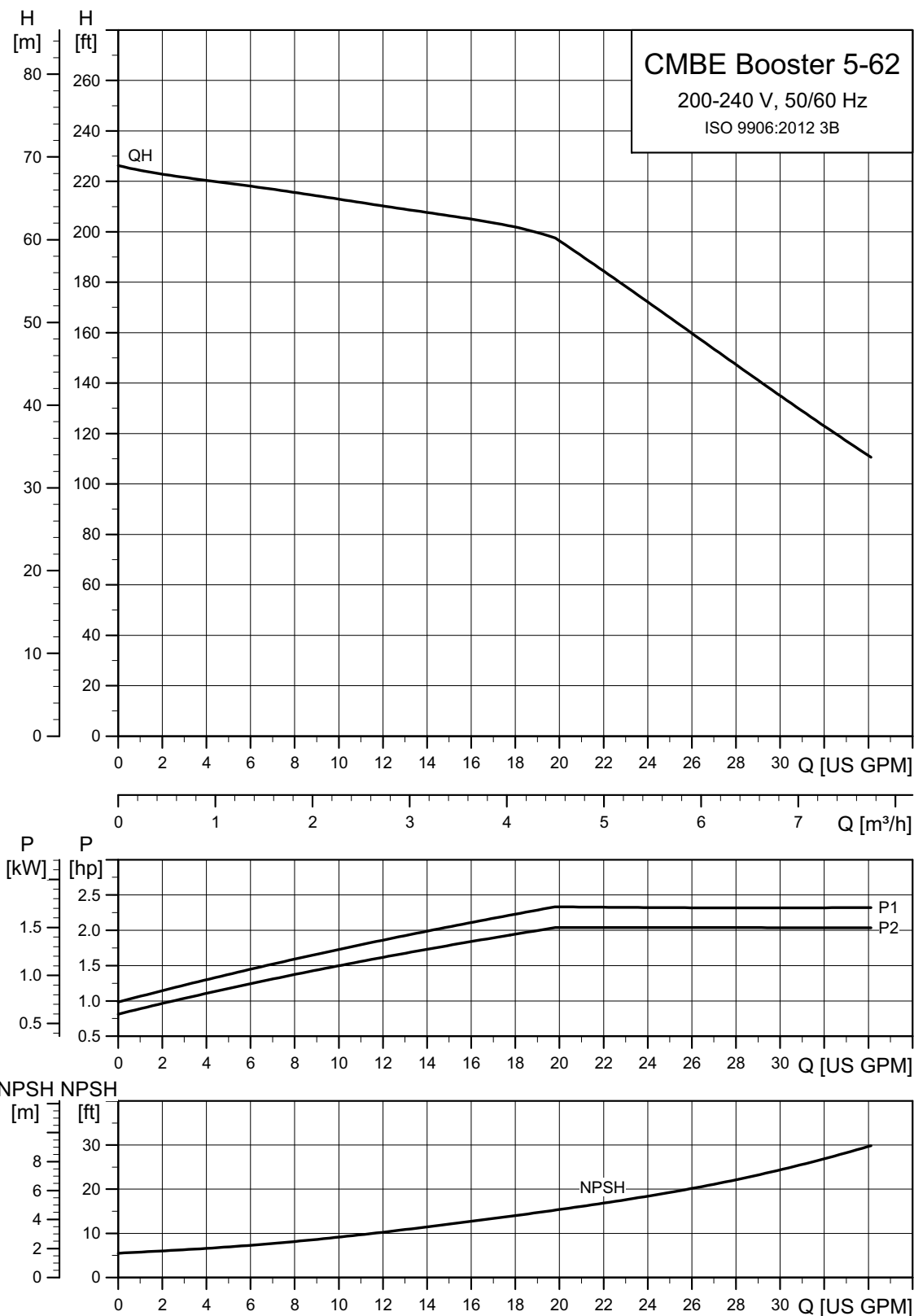

TM06 3398 0115

CMBE 10-54

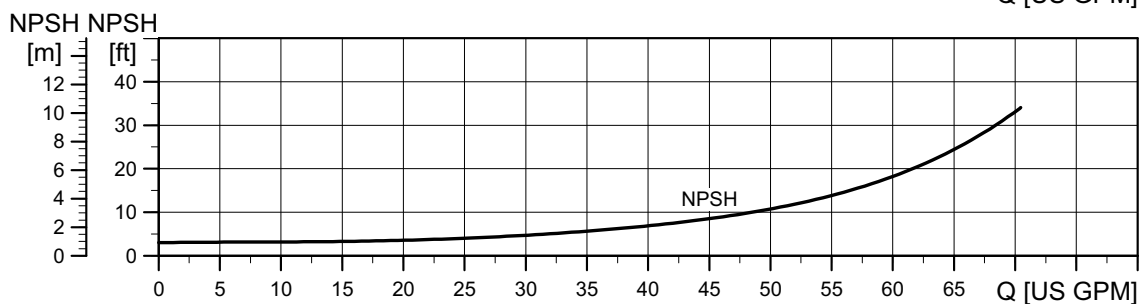
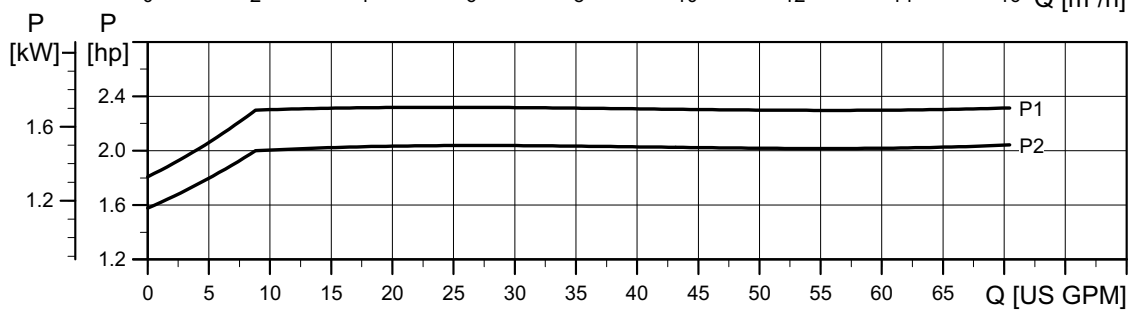
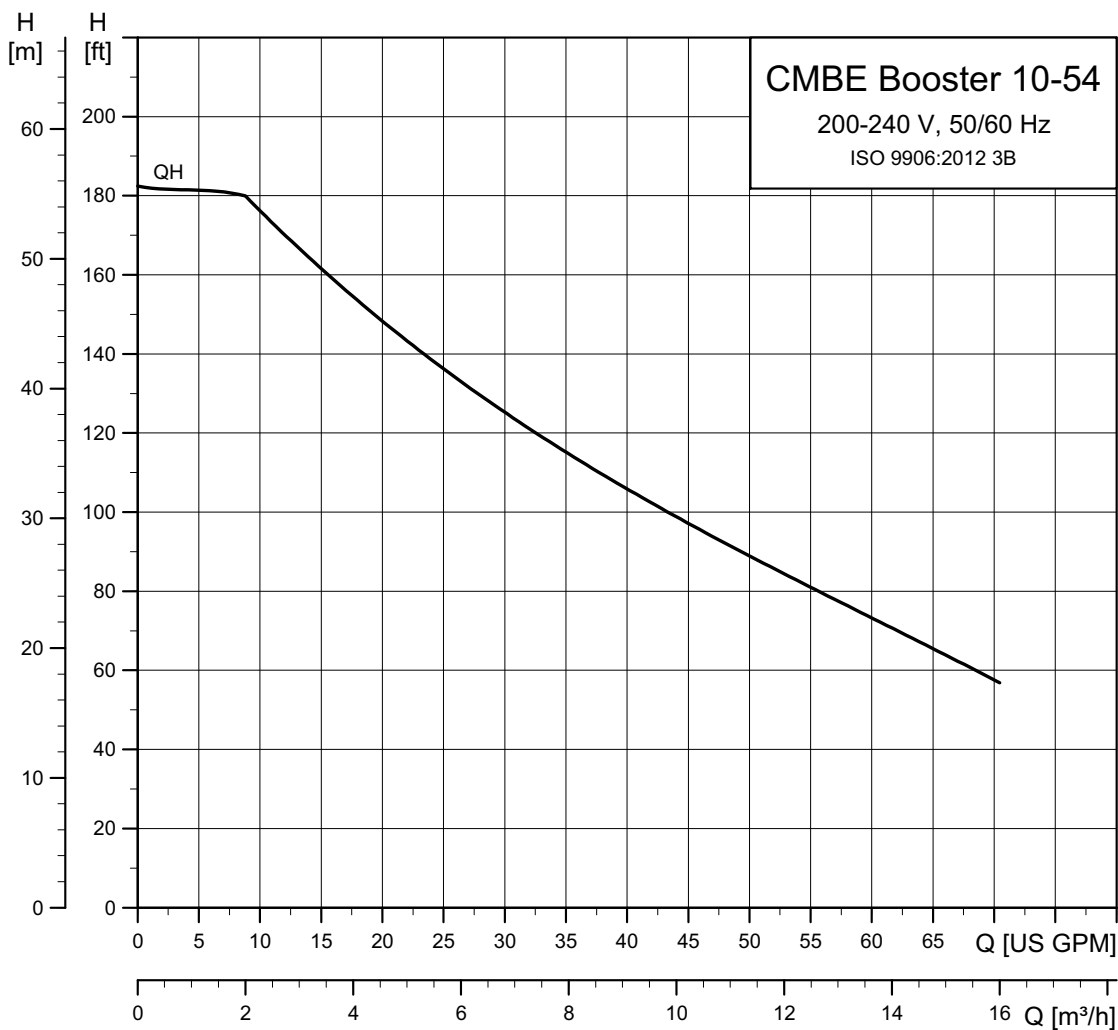

TM06 3400 0115

4. Grundfos Product Center

Online search and sizing tool to help you make the right choice.

<http://product-selection.grundfos.com>



SIZING enables you to size a pump based on entered data and selection choices.

REPLACEMENT enables you to find a replacement product. Search results will include information on

- the lowest purchase price
- the lowest energy consumption
- the lowest total life cycle cost.

The screenshot shows the Grundfos Product Center website. At the top, there is a navigation bar with the Grundfos logo and 'PRODUCT CENTER'. Below this is a secondary navigation bar with tabs: HOME, FIND PRODUCT, COMPARE, YOUR PROJECTS, SAVED ITEMS, and HELP. A search bar is located below the navigation, with a 'SEARCH' button. Below the search bar are four main categories: SIZING (Enter pump sizing), CATALOG (Product and services), REPLACEMENT (Replace an old pump with a new), and LIQUIDS (Find liquid pump). Below these categories is a 'QUICK SIZING' section with input fields for 'Enter duty point' (Flow (Q)* and Head (H)*) and 'Select what to size by' (Size by application, Size by pump design, Size by pump family). A 'START SIZING' button is also present. At the bottom of the quick sizing section, there are options for 'ADVANCED SIZING' (Advanced sizing by application and Guided selection).

CATALOG gives you access to the Grundfos product catalog.

LIQUIDS enables you to find pumps designed for aggressive, flammable or other special liquids.

All the information you need in one place

Performance curves, technical specifications, pictures, dimensional drawings, motor curves, wiring diagrams, spare parts, service kits, 3D drawings, documents, system parts. The Product Center displays any recent and saved items — including complete projects — right on the main page.

Downloads

On the product pages, you can download Installation and Operating Instructions, Data Booklets, Service Instructions, etc. in PDF format.

Grundfos GO

Mobile solution for professionals on the GO!

Grundfos GO is the mobile tool box for professional users on the go. It is the most comprehensive platform for mobile pump control and pump selection including sizing, replacement and documentation. It offers intuitive, handheld assistance and access to Grundfos online tools, and it saves valuable time for reporting and data collection.



GET IT ON
Google play

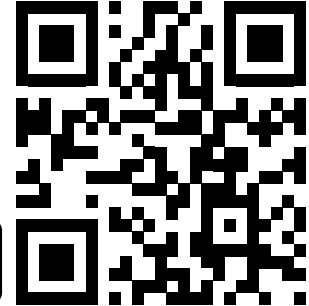

Available on the
App Store

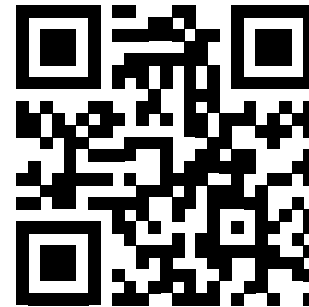

98647967 0515

ECM: 1153136

Grundfos Kansas City

17100 West 118th Terrace
Olathe, Kansas 66061
Phone: 913-227-3400
Fax: 913-227-3500
www.grundfos.us

Grundfos Canada

2941 Brighton Road
Oakville, Ontario L6H 6C9 Canada
Phone: +1-905-829-9533
Fax: +1-905-829-9512
www.grundfos.ca

Grundfos México

Boulevard TLC No. 15
Parque Industrial Stiva Aeropuerto
C.P. 66600 Apodaca, N.L. Mexico
Phone: 011-52-81-8144 4000
Fax: 011-52-81-8144 4010
www.grundfos.mx