

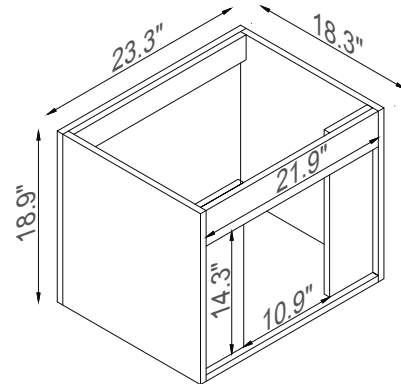

Streamline

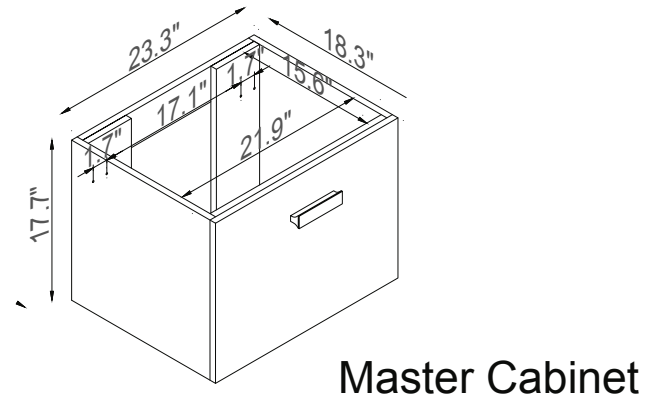
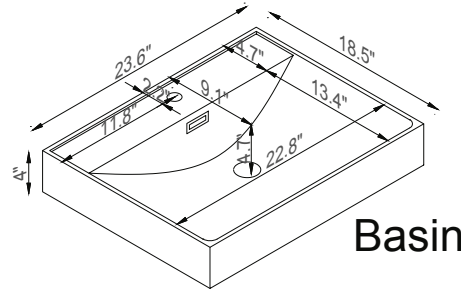
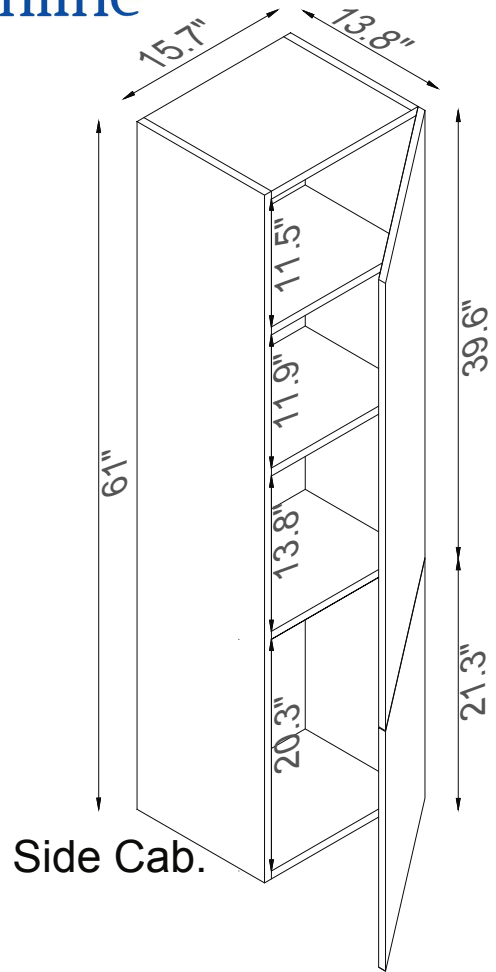

K1801-170-24-511S