

## MATERIAL SELECTION GUIDE AND INSTALLATION INSTRUCTIONS

\* Note – When product is installed in Florida see Approval # FL 5896 for installation instructions with specific adherence to the 2004 Florida Building Code.

[http://www.floridabuilding.org/pr/pr\\_detl.asp?IPT=5896&RV=0&fm=ROSrch](http://www.floridabuilding.org/pr/pr_detl.asp?IPT=5896&RV=0&fm=ROSrch)



- Attractive:** Aluminum won't split, rot, or warp. Baked on finish resists peeling, cracking, chipping, and blistering.
- Easy To Work With:** Aluminum can be cut with a sharp blade, metal snips, or circular saw. Fasten it with a hammer and (aluminum) nails. It's lightweight but strong.
- The Permanent Outdoor Material:** Proven over the past 50 years in siding, storm, and screen doors and many other applications.

### COMPONENTS

#### PANEL SUPPORTS

(twelve foot lengths)  
Used to support the overhang panels.

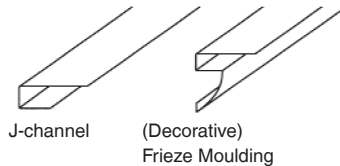

#### OVERHANG PANELS (SOFFIT)

(twelve foot lengths)  
These lengths are cut into individual panels to match the depth of your overhang. They come either solid or vented.

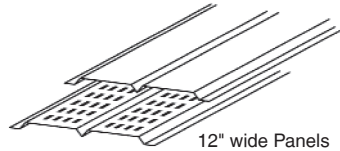

#### FRONT TRIM

(twelve foot lengths)  
Used to cover the wood trim to which your gutter is attached. Now is a good time to decide on replacing your old gutters with an AMERIMAX RAIN CARRYING SYSTEM. The front trim may be slipped under the existing gutter if it is not removed. If front trim is not used, additional panel supports are required.

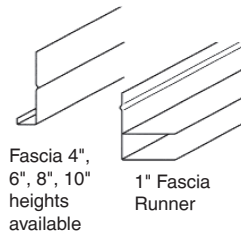

#### DOUBLE CHANNEL RUNNER

(twelve foot lengths)  
May be used instead of butting J channels at mitred corners.

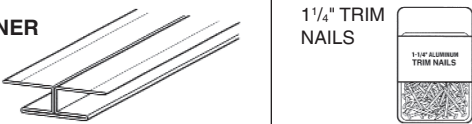

#### A WORD ABOUT VENTED OVERHANG PANELS

Amerimax vented panels allow outside air to pass through the roof rafters into your attic. Your attic exhaust system completes this important air circulation loop. Adequate ventilation is required to prevent:

- Energy losses in summer from a super-heated attic
  - Energy losses in winter caused by attic insulation that has soaked up condensation and moisture.
  - Peeling paint and rotting wood caused by condensation buildup inside the framework of the house.
- A solid wooden overhang allows none of this vital air circulation. For adequate ventilation, Amerimax recommends that a minimum of 1/3 of the aluminum overhang panels be vented panels.

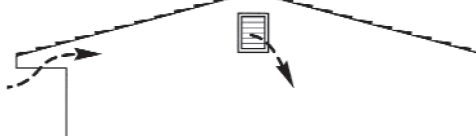

### MEASURING FOR YOUR PROJECT

#### A. TOTAL OVERHANG LENGTH (feet)

Measure the length (L) of overhang on all sides of your house. Add all these measurements to get the total overhang length, in feet.

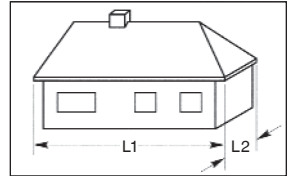

#### B. OVERHANG DEPTH (inches)

Identify your project from the illustrations below and measure the overhang depth, in inches, to the nearest 1/8 of an inch.

#### INSTALLING A HORIZONTAL OVERHANG

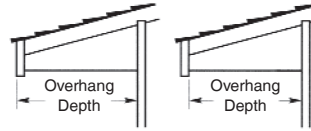

Project I using Front Trim      Project II not using Front Trim

#### INSTALLING AN INCLINED OVERHANG

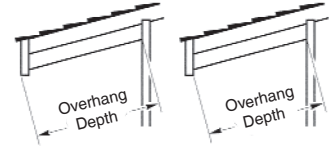

Project III using Front Trim      Project IV not using Front Trim

### MATERIAL SELECTION GUIDE

#### PANEL SUPPORTS: J-CHANNEL OR FRIEZE MOULDING (twelve foot lengths)

##### For projects I and III

Divide total overhang length (in feet) by 12 and round up to the nearest whole number. If not using double channel at mitred corners, add one additional length if overhang turns a corner.

*Example:* Total Overhang Length = 80 feet  
 $80 \div 12 = 6 \frac{8}{12}$  lengths

You need 7 twelve foot lengths plus one length if overhang turns a corner and you are not using a double channel runner at mitred corner.

##### For projects II and IV

Divide total overhang length (in feet) by 6 and proceed as above.

*Example:* Total Overhang Length = 80 feet  
 $80 \div 6 = 13 \frac{2}{6}$  lengths

You need 14 twelve foot lengths plus one length if overhang turns a corner and you are not using double channel runner at mitred corner.

#### OVERHANG PANELS: SOFFIT (12" x twelve foot lengths)

##### LOCATE YOUR OVERHANG DEPTH

From 7" to 8 1/8"	Divide total overhang length (in feet) by 18 and round up to nearest whole number. <i>Example:</i> total overhang length = 80 feet $80 \div 18 = 4 \frac{8}{18}$ lengths You need 5 twelve foot lengths.
Over 8 1/2" to 9 3/4"	Divide total overhang length (in feet) by 15 and proceed as above.
Over 9 3/4" to 12 1/8"	Divide total overhang length (in feet) by 12 and proceed as above.
Over 12 1/8" to 16 1/8"	Divide total overhang length (in feet) by 9 and proceed as above.
Over 16 1/8" to 24 1/8"	Divide total overhang length (in feet) by 6 and proceed as above.
Over 24 1/8" to 48 1/8"	Divide total overhang length (in feet) by 3 and proceed as above.

*Remember: Decide on how many solid and how many vented panels you want. The answers you get above are the total number of panels you need.*

#### FRONT TRIM: Fascia or 1" Fascia Runner (twelve foot lengths)

Divide total overhang length (in feet) by 12 and round up to nearest whole number.

*Example:* total overhang length = 80 feet  
 $80 \div 12 = 6 \frac{8}{12}$  lengths

You need 7 twelve foot lengths.

#### NAILS:

Only aluminum nails should be used. One box (1/4 pound) of Amerimax 1/4" aluminum trim nails should be sufficient for your entire project.

#### TOOLS REQUIRED

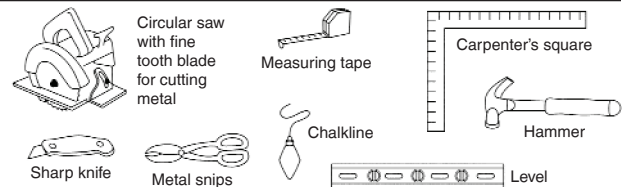

#### CAUTION:

When nailing aluminum, hammer only until nail head touches aluminum surface. Further hammering may prevent normal expansion and cause buckling.



#### Before You Begin

Remove an existing trim. Consider possible obstructions such as utility lines. Panels may be cut to fit around them or contact your utility company for removal or replacement.

## STEP 1. INSTALL PANEL SUPPORTS (J-CHANNEL or FRIEZE MOULDING)

- Always start at one end of the house.
- No overlap is needed where lengths meet.
- Nail on approximate 16" centers.

### FOR PROJECTS I AND III, WHERE NEW OVERHANG WILL BE ON THE SAME ANGLE AS EXISTING OVERHANG OR RAFTERS

Install along wall of house by nailing through long leg into existing wooden overhang or rafters.

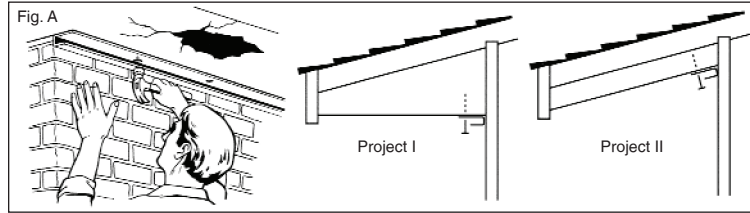

### FOR PROJECT I, WHERE YOU ARE CHANGING FROM AN INCLINED OVERHANG TO A HORIZONTAL OVERHANG

Mark point on wall level with bottom edge of wooden front trim at both corners (A). Strike a chalkline between the two points. Make 1" wide nailing flanges on long edge of panel supports by notching with metal snips and bending up. Fasten panel supports to wall with long side up and top horizontal edge even with chalkline, nailing through flanges.

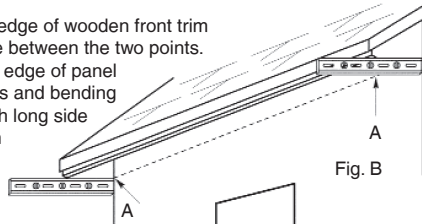

### FOR PROJECTS II AND IV WHERE NEW OVERHANG WILL BE ON THE SAME ANGLE AS EXISTING OVERHANG RAFTERS

Install along inside of wooden front trim by nailing through long leg or into existing overhang or rafters.

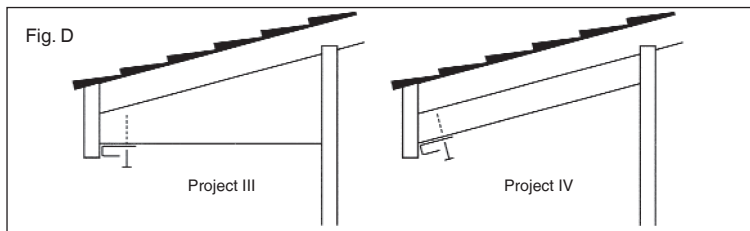

At one end of house, install **only one length** along the wall by nailing through long leg into existing wooden overhang or rafters (see Fig. A). Successive lengths will be installed along the wall **after** the overhang panels have been installed into the previous lengths.

### FOR PROJECT II, WHERE YOU ARE CHANGING FROM AN INCLINED OVERHANG TO A HORIZONTAL OVERHANG

Install along inside of wooden front trim (see Fig. D). Follow procedure illustrated in Fig. B to strike a chalkline on wall. Chalkline should be level with bottom leg of panel support. At one end of house, install only one length along the wall by forming 1" wide nailing flanges and nailing to wall with bottom horizontal edge even with chalkline. Successive lengths will be installed along the wall after the overhang panels have been installed into the previous lengths.

## STEP 2. INSTALL OVERHANG PANELS (Soffit)

### FOR ALL PROJECTS:

Subtract ¼ inch (for clearance) from your measured overhang depth. Using this new dimension, cut the twelve foot lengths into individual panels, using your circular saw with fine tooth metal cutting blade.

Always start at one end of the house. The first panel must be installed with interlocking-nailing edge square with the wall and positioned to receive the next panel.

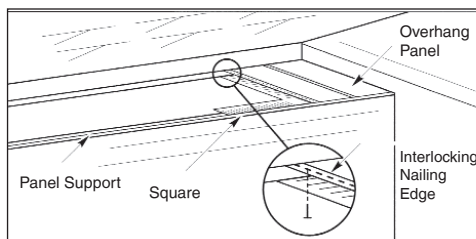

**Important:** Decide on the solid vs. vented pattern you wish to use. If you are covering an existing overhang you should cut a hole in the old overhang (to the approximate panel size) at each vented panel in order to achieve the desired air circulation.

## FOR PROJECTS I AND III

Insert each panel into support and approximately even with outside edge of wooden front trim. Install each successive panel, pushing it up against the previous panel until it interlocks, before nailing into the bottom of the wooden front trim.

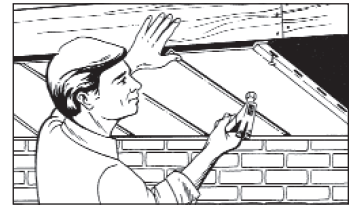

## FOR PROJECTS II AND IV

Install the panel by sliding it into the tracked formed by the two panel supports. Install each successive panel, pushing it against the previous panel until it interlocks. Proceed until panel support against wall is filled. Install one additional length of panel support against the wall, as before. Proceed with installation of panels and panel supports.

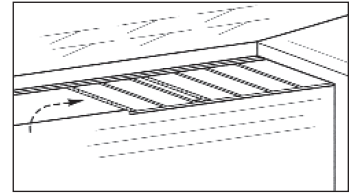

## Going Around Corners

If inside or outside corners are involved, make a mitre joint by butting two J-channels back to back as shown, or use Double Channel Runner. Cut the soffit panels at the proper angle to fit.

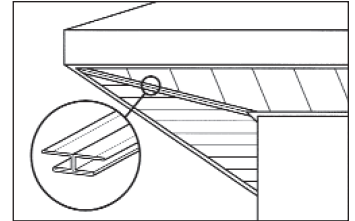

## STEP 3: INSTALL FRONT TRIM (Fascia or 1" Fascia Runner)

**Note:** If you are removing your existing gutter, mark the locations of the rafters so you can remount your gutter by fastening into the rafters, which is preferred over fastening to the wooden front trim.

### When turning a corner

Wrap-around should be about 2". Cut out the bottom lip with metal snips and blend front trim as shown. The first piece used after turning the corner should overlap and come completely to the corner. Starting at one end, place front trim with bottom lip snug against the overhang panels. The top edge may be slipped under box style guttering if it has not been removed. Nail as shown on approximate 16" centers. Do not overdrive nails. When installing the next length, overlap the first by ½" to 1" and nail through the overlap joint.

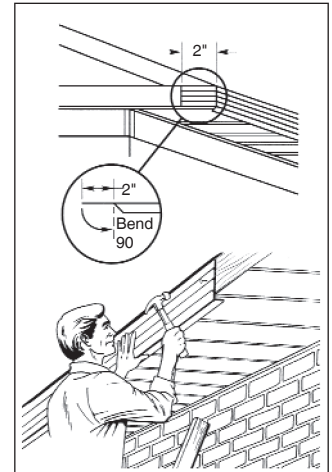

## ROOF GABLE BOARDS

Amerimax Fascia can also be used to cover Gable Boards. Follow, the same procedure as above, mitre cutting the panels at the peak.

## CLEANING INSTRUCTIONS

Aluminum can be cleaned by using a mild soap and water solution. You should never use abrasive cleaners or pads.

# Amerimax Home Products, Inc.

[www.amerimax.com](http://www.amerimax.com)  
(800) 347-2586  
Lancaster, PA 17604