



**KEGERATOR BEER KEG  
REFRIGERATOR (6 CU. FT.)  
MODELS: KEG6000, KEG6000B  
OPERATING MANUAL**

# **FROSTY KEG KEG6000**

- ⚡ Easy-Pull Beer Dispenser
- ⚡ 21.3"W x 26.6"D x 33.2"H (with casters)
- ⚡ Convenient Drip Tray
- ⚡ Sturdy Casters for Extra Mobility
- ⚡ Easy Setup & Installation
- ⚡ 6.0 cubic feet/170 liters/44.9 gallons
- ⚡ Handy Guardrail
- ⚡ Dual-Gauge CO2 Regulator
- ⚡ 115V/60Hz 1.9Amps

This product should be recycled at the end of its usefulness; turn over to a licensed electrical recycling point. Materials are recyclable. Please make an effort to have a positive impact on the environment.

## **SPECIFICATIONS**

**Weight:** 88lbs.

**Refrigerant:** R134A, 2.82OZ

**High Side Pressure:** 300psi

**Low Side Pressure:** 88psi



### **Polarized Electrical Power Plug:**

This appliance is equipped with polarized plug; this type of plug has one blade wider than the other. The plug will fit into an electrical outlet only one way. This is a safety feature intended to reduce the risk of electrical shock. If you are unable to insert the plug into the outlet, try reversing the plug. If the plug should still fail to fit, contact a qualified electrician to replace the obsolete outlet. Do not attempt to defeat the safety purpose of the polarized plug by modifying the plug in any way.

## **CUSTOMER SERVICE**

Customer service and product support are available on line at [www.greatnorthernpopcorn.com](http://www.greatnorthernpopcorn.com).

## **WARRANTY AND RETURN POLICY**

All Great Northern Popcorn Company kegerators are warrantied against defects in material and workmanship for a period of one year for residential and personal use under normal conditions. Warranty is limited to replacement parts.

Our return policy allows 30 days from the date of delivery to return products, provided it is new, unused and in the original packaging as received. We highly recommend that the buyer thoroughly inspect the purchased product before using it. We charge a 20% restocking charge on all returned items. Return shipping is the responsibility of the buyer. We cannot accept returns for any reason after 30 days from the date of delivery. A credit will be issued after the item is inspected and accepted.

All shipping damages must be claimed with the designated shipper. Check the shipping carton for damage before signing the bill of lading.

If an item is opened and deemed to be defective within 30 days from the date of delivery, please contact us at [www.greatnorthernpopcorn.com](http://www.greatnorthernpopcorn.com) for return instructions. A Great Northern Popcorn Company RMA is required when returning defective merchandise. When returning your order please include a copy of your order number with date purchased, your Great Northern Popcorn Company RMA and the reason for the return.

Warranty shall not apply to: products which are used for a purpose other than which they were designed for or which have been altered in any way that would be detrimental to the performance or life of the product. Misapplication, misuse or negligence will revoke the warranty.



**IMPORTANT - All persons that will operate this equipment must read**

**and become thoroughly competent with all operating procedures and safety precautions. Misuse of this equipment may result in death,**

## GENERAL SAFETY PRECAUTIONS



1. You will need this manual for the safety warnings and precautions, operating, inspection, maintenance and cleaning procedures, parts list and assembly diagram. Keep your invoice with this manual. Write the invoice number on the inside of the front cover. **Keep this manual and invoice in a safe and dry place for future reference.**



2. The warnings, cautions and instructions discussed in this instruction manual cannot cover all possible conditions and situations that may occur. It must be understood by the operator that common sense and caution are factors which cannot be built into this product, but must be supplied by the operator.



3. **NEVER** use this product for anything other than its intended use. **NEVER** modify this product. Failure to comply with the precautions, warnings and recommendations in this manual will nullify your warranty and may result in injury or even death.



4. **ALWAYS** ensure that this kegerator is plugged into a grounded outlet with the proper power supply available.



5. **DO NOT** unplug the machine by pulling or tugging on the power cord. Firmly grasp the plug and remove from outlet.



6. **MAKE SURE** that the power outlet, plug and power cords used are in good condition. Worn, frayed or damaged plugs, cords and outlets should be replaced or repaired by a certified electrician who is properly qualified to meet local safety and electrical codes. Power supply cords should be replaced by the manufacturer.

**AVOID using extension cords or 3-prong adaptors.**



7. To reduce the risk of electrical shock or fire, **MAKE SURE** that your unit is properly grounded. **NEVER TAMPER WITH, REMOVE OR CUT THE GROUNDING PIN!!** The wall outlet used with this kegerator **MUST** be properly grounded. If you do not have a grounded outlet, have one installed by a certified electrician who is properly qualified to meet local safety and electrical codes.



8. Make sure your machine is unplugged when you conduct any maintenance or repair. A qualified service technician should always perform service or repair.



9. This product is not intended for commercial use.



10. **Do not cover the power cord. DO NOT** immerse cord in water or use in high traffic areas. **DO NOT** run cord over carpets or heating sources or elements. **NEVER** use with damaged cords or plugs.



11. **INTENDED FOR UPRIGHT, FREESTANDING USE ONLY.** Do not install in cabinet or enclosed spaces.



12. **DO NOT operate with missing or broken parts.**



13. This product is intended for **INDOOR USE ONLY. DO NOT USE OUTDOORS.**



14. **Only qualified repair personnel should perform generator service.** Service or maintenance performed by unqualified personnel could result in injury.



15. **Do not operate this kegerator in explosive atmospheres, such as in the presence of flammable liquids, gases, or dust.**



16. **DO NOT** tamper with or modify the controls.



17. **DO NOT** roll a loaded kegerator over carpeting. Make sure your unit is empty before moving it.



18. **KEEP UPRIGHT** when transporting. **DO NOT ALLOW TO TILT PAST 45 DEGREES. DO NOT UPEND OR TURN UPSIDE DOWN.**

## CHILD SAFETY PRECAUTIONS

19. **WARNING!** Children must be supervised around this machine. Make sure that children know that this kegerator is **NOT A TOY**. Close door during operation and leave closed at all times when children are present

20. If you are disposing of this machine, we recommend that you remove the door but leave the shelves in to reduce the risk of injury to children.



**IMPORTANT** - All persons that will operate this equipment must read and become thoroughly competent with all operating procedures and safety precautions. Misuse of this equipment may result in death,

## **WARNINGS & DANGER NOTICES**

**WARNING:** Because of inherent dangers from faulty or inferior cords, avoid the use of extension cords. When you cannot avoid their use, be sure that the cord is a 3-wire cord with a 3-prong grounded plug. The cord should be rated for **AT LEAST** 1875 Watts and a No. 14 AWG minimum size.

**DANGER!** If you are disposing of this machine, we recommend that you remove the door but leave the shelves in to reduce the risk of injury to children. **DO NOT ALLOW CHILDREN TO BECOME TRAPPED.**

**ALWAYS** supervise children when using this product and be sure that children are not playing with the unit.

## **LOCATION RECOMMENDATIONS**

1. **INDOOR USE ONLY, DO NOT ATTEMPT TO USE OUTDOORS.**
2. **INTENDED FOR UPRIGHT, FREESTANDING USE ONLY.** Do not install in cabinet or enclosed spaces.
3. Get the most out of your kegerator! To maximize efficiency and long life, use near a proper electrical outlet and ensure that there is adequate ventilation and clearance around the unit. **Allow at least 5 inches clearance around all sides of the kegerator.**  
**Dimensions:** 21.3"W x 26.6"D x 33.2"H (with casters)
4. Avoid locations where this unit will be in contact with heating elements or direct sunlight.

## **CO<sub>2</sub> SAFETY PRECAUTIONS, WARNINGS & DANGER NOTICES**

1. **DANGER!** Carbon dioxide is a potentially dangerous gas. Canisters or cylinders are under pressure and proper handling is essential for safety. Familiarize yourself with canister installation and replacement before operating this unit. **HANDLE WITH CARE.** Never jostle, toss or treat cylinders roughly. If you experience headache or difficulty breathing, a leak may be occurring; open windows and doors to ventilate the area and leave immediately.
2. **INTENDED FOR UPRIGHT, FREESTANDING USE ONLY.** Do not install in cabinet or enclosed spaces.
3. Store CO<sub>2</sub> canisters away from heat or explosive gasses. Keep in a cool, dry space (<70 degrees F) and chain containers upright to avoid tipping or knocking. Always wear gloves and safety glasses when around chemicals.
4. Review and follow instructions for changing CO<sub>2</sub> cylinders. **NEVER CONNECT A CO<sub>2</sub> CANISTER DIRECTLY TO THE UNIT!** To avoid potential explosion that could result in grave injury or even death, **ALWAYS CONNECT THE CANISTER TO THE CO<sub>2</sub> REGULATOR.** 2 safety valves are located separately; safety valve in the regulator and safety valve in the CO<sub>2</sub> canister. **DO NOT REMOVE VALVES, DO NOT EXCEED 60PSI.**
5. **DO NOT ATTEMPT TO REFILL CO<sub>2</sub> CANISTERS!!** Refills are available where most canisters are sold (see page 7 for more information).

# KEGENERATOR PARTS

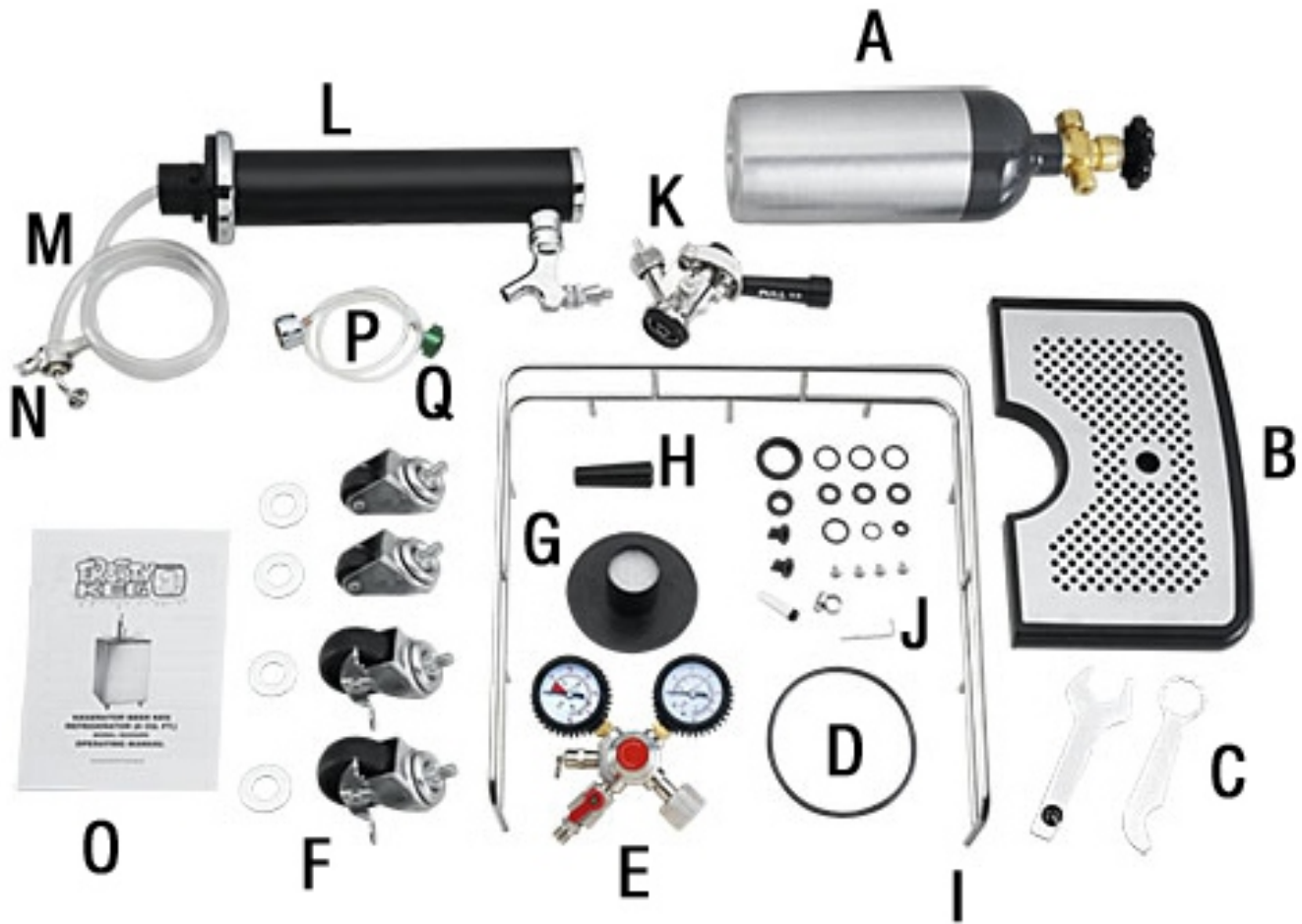

## FROSTY KEG PARTS LIST

- A: CO<sub>2</sub> CANISTER
- B: DRIP TRAY
- C: WRENCHES
- D: CO<sub>2</sub> CANISTER STRAP
- E: DUAL GAUGE REGULATOR
- F: CASTERS AND WASHERS
- G: BEER TOWER PLUG
- H: BEER TOWER SPIGOT HANDLE
- I: GUARDRAIL
- J: EXTRA WASHERS, BEER CHOKE FLOAT, ALLEN WRENCH, CO<sub>2</sub> LINE WASHERS
- K: KEG COUPLER
- L: BEER TOWER
- M: BEER LINE
- N: BEER LINE COUPLER
- O: MANUAL
- P: CO<sub>2</sub> LINE
- Q: GREEN CO<sub>2</sub> LINE COUPLER
- R: KEG BOARD (NOT PICTURED)

# KEGERATOR FLOW AND PARTS

SAVE THESE INSTRUCTIONS

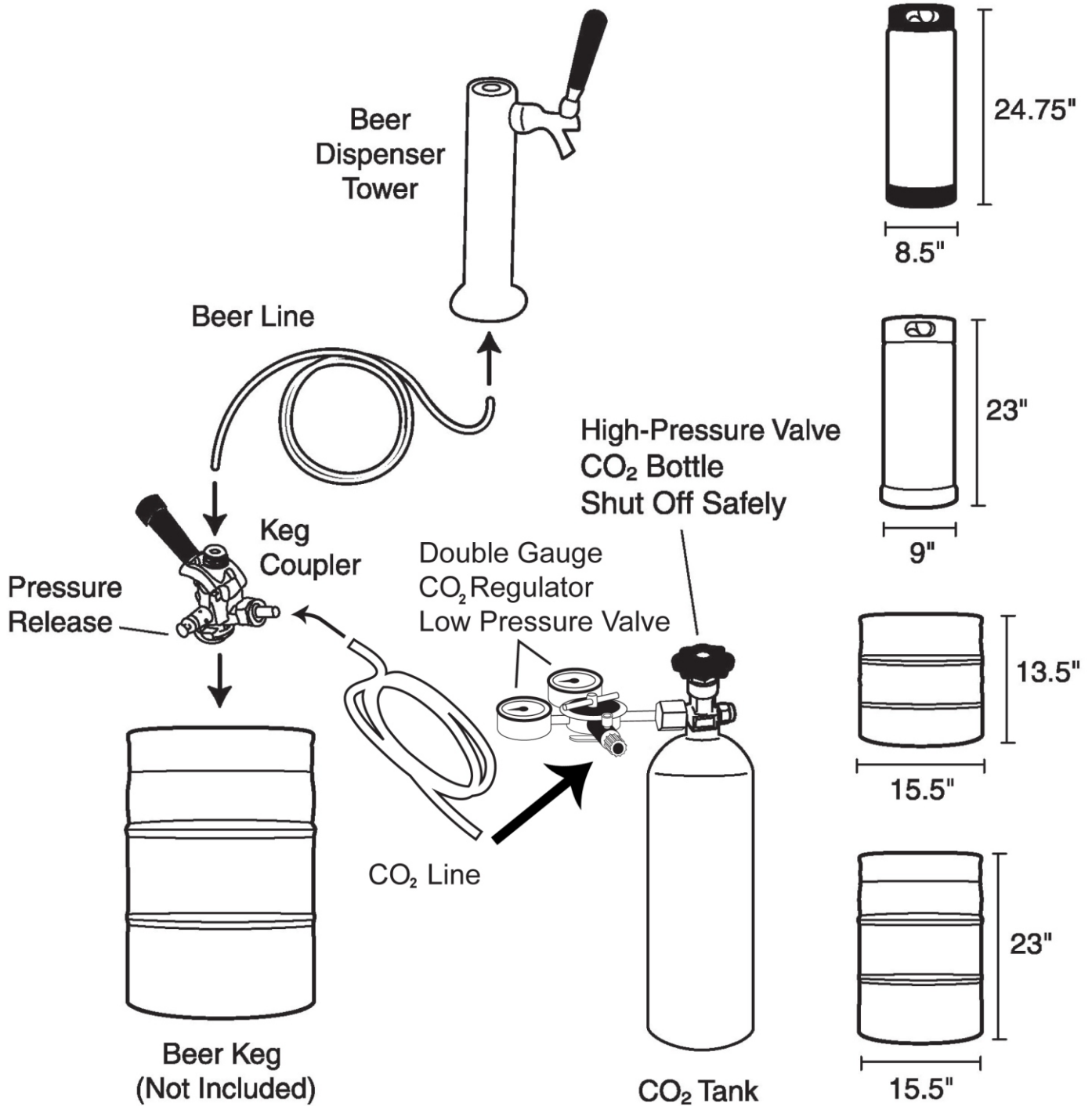

# UNPACKING YOUR KEGERATOR

Be sure that you are thoroughly familiar with the assembly and installation process before turning on your kegerator.

**IMPORTANT!** You should position your unit in an upright position and allow to sit for at least 8-10 hours before plugging into an outlet. This will allow any refrigerant that has moved to settle back to where it should be before operation.

## REMOVING PACKAGING

1. Your kegerator is shipped in double-walled cardboard for maximum protection (Figure 1). Remove this cardboard carefully. You may wish to leave the bottom cardboard panel beneath the kegerator to protect flooring when assembling guardrail, tower, tank and casters.
2. Your kegerator is also shipped with a protective plastic lining (Figure 2) on the door to protect it during assembly. To prevent scratches or accidental blemishes during the assembly process we recommend leaving this coating on until assembly is complete.
3. The unit is shipped ready for refrigerator use (Figure 3) with shelves in place. To use as a refrigerator simply remove the packaged parts and the keg board, insert the beer tower plug (see page 5 for parts list), adjust the temperature settings, and after allowing ample time for the refrigerant to settle after shipping, plug in the unit. To assemble as a kegerator follow the rest of the assembly steps in this manual.
4. Remove shelves, shelf rack and packaged parts from the kegerator cabinet. Unpack the parts and consult page 5 to become familiar with all assembly parts. Note: your unit ships with several extra washers; please be sure to keep these in a safe place with the manual in case you should ever need them.



Figure 1

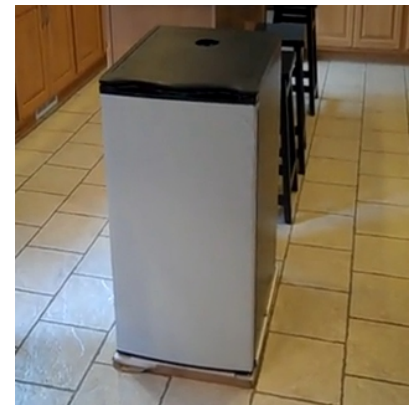

Figure 2



Figure 3

# KEGERATOR ASSEMBLY

## CASTER ASSEMBLY

1. To install the casters (page 5, F), first make sure everything is removed from the kegerator cabinet, then tilt the front side of the unit back slightly on a dry and padded surface. Do not tilt more than 30 degrees when installing casters to avoid jostling any refrigerant.
2. Install casters into holes on bottom of kegerator as shown in Figure 4 and tighten with a 3/8" wrench (not provided). Two of the four casters provided are equipped with locks to prevent slipping of the keg on smooth surfaces such as hardwood floors, linoleum or tile. **These casters should be installed on the front of the unit. IMPORTANT! Casters should be installed with wrench to prevent breakage!**
3. Once all 4 casters are attached return the kegerator to an upright position and allow to remain for at last 8-10 hours (see **Note** above).

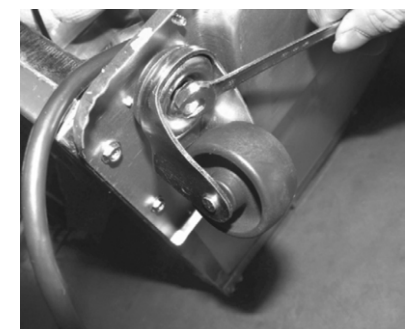
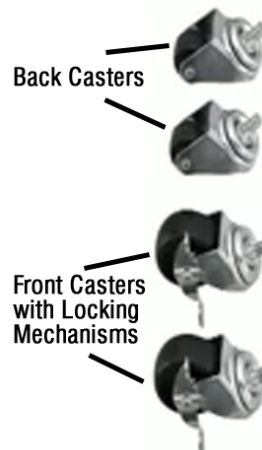

Figure 4

# KEGERATOR ASSEMBLY

## BEER TOWER INSTALLATION

1. To install the beer tower (page 5, L), first, thread the rubber gasket over the beer line (M) and seat over the notches on the base of the dispenser assembly so that it lays flat (Figure A). **Note:** While not required, we recommend the use of the black rubber gasket when installing the beer tap. Using the gasket will provide a more secure seating for the arm assembly (see figures A, B, C and D).
2. Next, line up the draft arm notches with the notches in the hole in the top of the kegerator.
3. Feed first the beer line (Figure B), then the base of the tower, into the hole, making sure that the notches are aligned properly.
4. Slide tower down and twist (Figure C) until it is secure (no screws or fasteners are necessary). The spigot of the beer tower should now be facing the front of the kegerator.
5. To complete the beer tower installation, screw on the spigot handle (Figure D).



Figure A



Figure B



Figure C

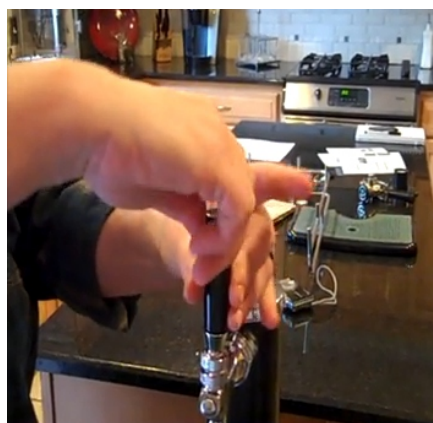

Figure D

## GUARDRAIL INSTALLATION

To install the guardrail, first:

1. Place the guardrail (page 5, I) atop the kegerator and line up the guardrail's feet with the holes on top of the cabinet.
2. Pop the guardrail gently into place, taking care not to scratch the top surface of the kegerator.

## DUAL REGULATOR SPECIFICS

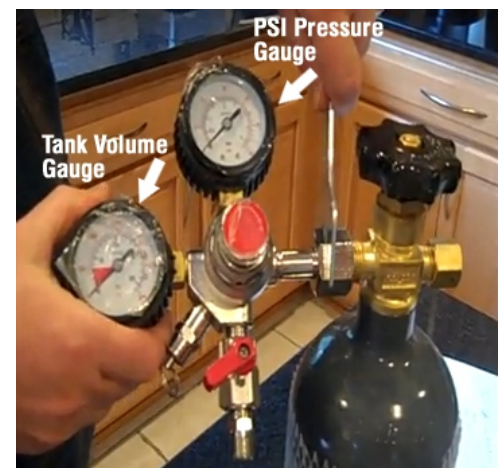



# KEGENERATOR ASSEMBLY

## CO<sub>2</sub> REGULATOR INSTALLATION

Proper installation of your CO<sub>2</sub> regulator and a thorough understanding of CO<sub>2</sub> canisters is essential to the safe use of this product. Review and follow instructions for handling CO<sub>2</sub> cylinders and this section in particular to ensure your safety and the safety of others.

**NEVER CONNECT A CO<sub>2</sub> CANISTER DIRECTLY TO THE UNIT! To avoid potential explosion that could result in grave injury or even death, ALWAYS CONNECT THE CANISTER TO THE CO<sub>2</sub> REGULATOR.**

**IMPORTANT!** Your CO<sub>2</sub> canister is shipped to you **EMPTY** for safety reasons. You will need to get this canister filled before you can use your unit. In most places you can get canisters filled at:

- ⊙ stores that sell kegs
- ⊙ party stores or convenience stores
- ⊙ fire and welding supply stores

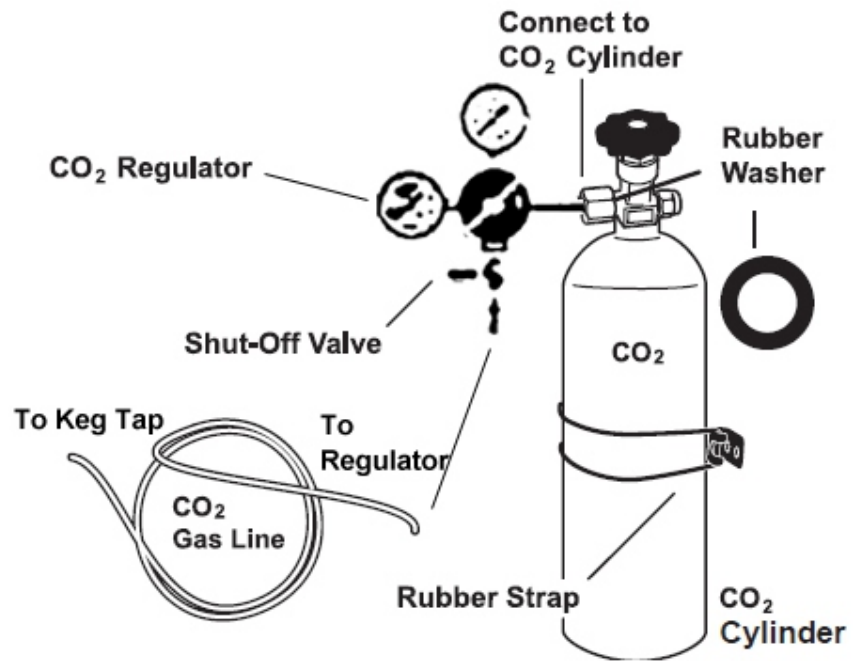

Figure E

**DO NOT ATTEMPT TO REFILL CO<sub>2</sub> CANISTERS YOURSELF!!**

**DANGER! Carbon dioxide is a potentially dangerous gas. Canisters or cylinders are under pressure and proper handling is essential for safety. ALWAYS HANDLE WITH CARE!**

### SPECIAL PRECAUTIONS

Ensure that the safety devices for your pressurized system are installed and remain installed. Once installed, **NEVER** remove the rubber washers in the regulator attachment nut to the canister or in the tap mechanism. **NEVER** bypass these safety features.

**Failure to comply will void your warranty and could result in serious injury or death!**

To install the dual-gauge regulator onto the CO<sub>2</sub> canister:

1. Insert the rubber black washer that comes with this unit (**Figure F**), into the attachment nut on the regulator (as shown in the photo, right, **Figure G**).
2. Next, loosen the pressure gauge on the regulator by turning the red knob all the way to the left. You may need to use the allen wrench provided (**Figure H**) to loosen the knob by turning the small set screw on the bottom of the knob.

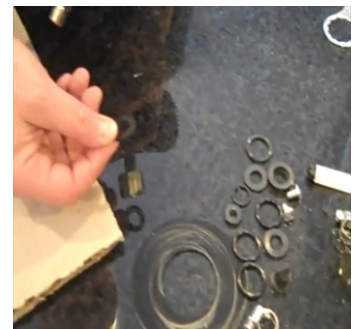

Figure F



Figure H



Figure G

# KEGENERATOR ASSEMBLY

## CO<sub>2</sub> REGULATOR INSTALLATION CONTINUED...

3. The knob may turn by hand, but if needed, use a pair of grips or pliers (**Figure I**) to get it started and then open by hand all the way to the left (**Figure J**).

4. Next, attach the regulator to the CO<sub>2</sub> canister as shown in **Figure K**. Hand tighten the coupler, then use the wrench provided (see page 5, C) to finish securing the connection.

**Note:** When attaching the regulator to the canister, make sure that the gauges remain upright as show in **Figure K**. This will ensure that the gauges will be easy to read when the canister is installed in the cabinet, and that the shut off valves are easily accessible. **Note: When facing the gauges securely installed, note that the topmost gauge indicates the PSI pressure flowing through the line to the keg and the left hand gauge indicates total tank pressure. See page 8.**



Figure I

5. Next, make sure that the CO<sub>2</sub> line washer is installed on the inside of the green coupler as shown in **Figure L**. If the washer is not present, remove one of the extra washers that are attached to the wrench and install as shown.

6. Next, attach the CO<sub>2</sub> line to the regulator as shown in **Figure M**. At this point perform the following checks:

a. Make sure that the red lever on the regulator that leads to the CO<sub>2</sub> line is in the OFF position, as is shown in **Figure M**. The lever should be perpendicular to the line.

b. Make sure that the round red pressure knob is opened all the way to the left and be sure that the CO<sub>2</sub> tank's valve is shut so that no gas is flowing.

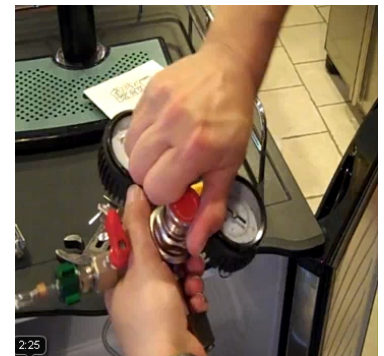

Figure J



Figure K

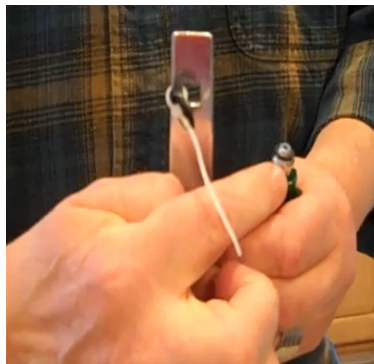

Figure L



Figure M

## SECURING THE CO<sub>2</sub> TANK INSIDE CABINET

1. Locate the canister strap (page 5, D). Loop the strap onto the back fastener located on the cabinet interior and place CO<sub>2</sub> tank, with regulator and CO<sub>2</sub> line attached, onto the back shelf.
2. Stretch the strap around the tank and hook one end of the strap loop to the foremost fastener on the cabinet as shown (Figure N). The strap will fit very snugly.
3. Double check that all connections are secure, that the green coupler on the CO<sub>2</sub> line is tightened and that all valves are OFF.

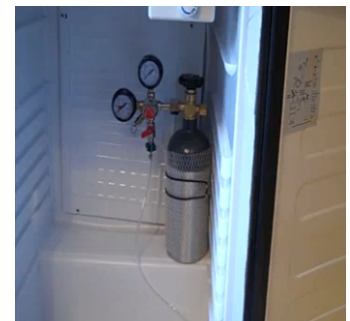

Figure N

# TAPPING THE KEG

## INSTALLING KEG TAP ON SINGLE BARREL TYPE KEG

This kegerator's coupler (page 5, E) is compatible with a ¼ pony keg sized barrel and a ½ barrel full size (U.S.A.). The kegerator is capable of holding a 5 gallon cornelius keg and a 5 gallon D system keg, you may discover that you will need to use an alternate keg coupler.

Your CO<sub>2</sub> canister has a capacity of 2.5 lbs. which will deliver approximately four 15 gallon kegs of beer.

### To tap a keg:

1. First, be sure that the keg coupler's black dispenser handle is closed (**pushed up**, see **Figure O**). Also, make sure that the tower dispenser (on top of kegerator) handle is closed before proceeding with tap to keg connection.
2. Next, check the bottom of the coupler to make sure that the black washers, which should be installed by the factory, are present and securely in place (**Figure P**). If the seals are not installed, check the extra washers (page 5, J) and insert to ensure a snug coupler/keg connection.
3. Insert the CO<sub>2</sub> line's black rubber washer into the coupler's side-most connector for the CO<sub>2</sub> line (there are two of these included in your packaging along with the other extra washers...they are hat shaped and taper to a pointed end with a slit to better regulate gas flow...see **Figure Q**). Insert tapered end first into coupler.
4. The topmost connection on the coupler is for the beer line. To prepare this connection first, locate the white plastic float (with extra washers packet, **Figure R**). Insert the float, black marble-shaped side down, into the beer line coupler connection.
5. Next, locate a metal spring as shown in **Figure S**, and insert small side down into the beer line coupler connection directly on top of the float.
6. With all washers, float and spring in place, fit the keg coupler into the top of the keg neck's slots (**Figure T**), being careful not to press down on the coupler handle. Press down and perform a quarter turn clockwise to lock the coupler and keg together. The keg is now tapped and you are ready to attach the CO<sub>2</sub> line and beer line to the keg coupler.



Figure O



Figure P



Figure Q



Figure R



Figure S

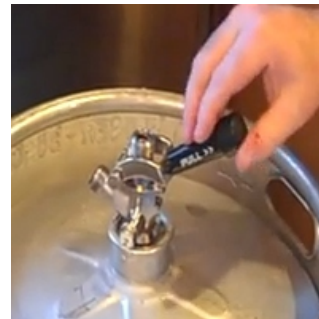

Figure T



Figure V

# KEGERATOR OPERATION

1. To begin using your kegerator you will need to attach the CO<sub>2</sub> line and the beer line to the keg. First, after double-checking to ensure that the silver end of the CO<sub>2</sub> line has a washer installed and that the keg coupler's CO<sub>2</sub> connection's hat-shaped washer is in place, attach the silver end of the CO<sub>2</sub> line to the CO<sub>2</sub> connection on the keg coupler (**Figure V**). Hand tighten securely.
2. Next, connect the beer line to the top of the keg coupler, making sure that the beer line coming down from the tower has a washer-gasket installed (**Figure W**). Hand tighten securely.
3. With both lines firmly connected to the keg coupler, finalize the connection by pulling the black tap handle out (**Figure X**) and pushing down until it clicks securely (**Figure Y**). There will be an audible click, signaling that the CO<sub>2</sub> and beer connections have been opened and that your keg is tapped.
4. Next turn the red **lever** on the CO<sub>2</sub> regulator so that it is inline and parallel with the CO<sub>2</sub> line (**Figure Z**). Open the CO<sub>2</sub> tank valve 1/4 to 1/2 turn to the left, then slowly engage the CO<sub>2</sub> by turning the red pressure gauge knob to the right until the regulator's PSI gauge reads between 10-12 PSI (**Figure AA**).



Figure W

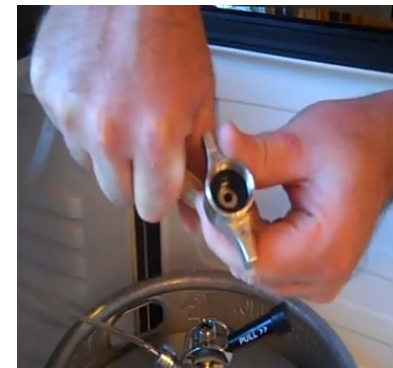

Figure W

Refer to the illustration below for a brief summary of the steps involved in preparing the kegerator to keg connection.



Figure X



Figure Y



Figure Z



Figure AA

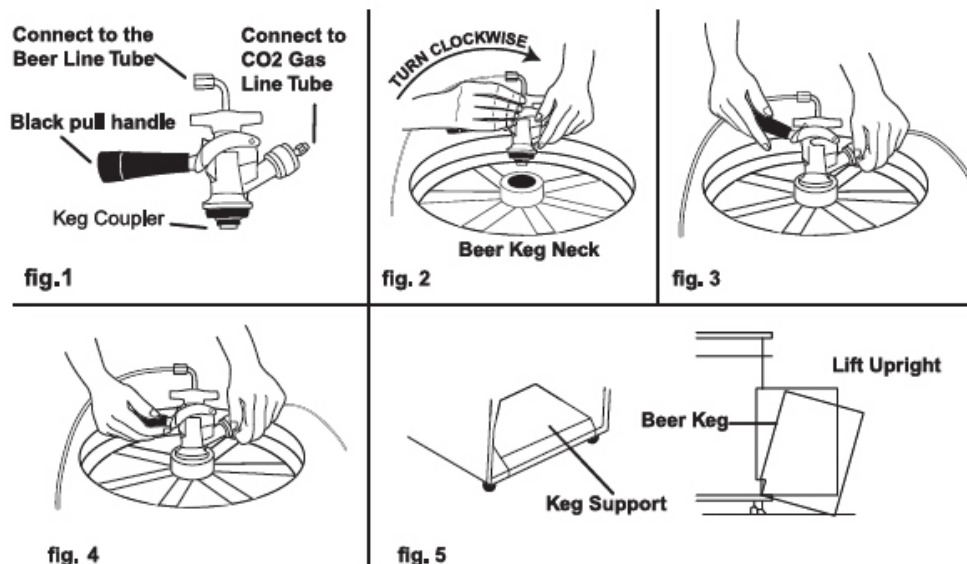

# KEGERATOR OPERATION

5. Locate the keg board (page 5, R) which is the white plastic raised bump board which you initially removed from the bottom floor of the kegerator during unpacking. Replace the keg board in the bottom of the kegerator, raised bump side down (**Figure AB**).
6. Next, carefully lift the keg atop the keg board and slide all the way into the kegerator (**Figure AC**). **HANDLE CAREFULLY.** Do not jostle or bang keg! Make sure that the kegerator door can close easily.
7. **IMPORTANT!!**  
If you want to plug in your kegerator, be sure that you are connected safely to the proper power supply: a 120V, 60Hz, 16 Amp grounded AC outlet. The cord should be rated for **AT LEAST 1875 Watts and a No. 14 AWG minimum size.**
8. Before opening the tower spigot, slide the drip tray beneath the spigot to catch excess beer, then pull the tower handle toward your body to open the tap and dispense beer. To pour a beer with a proper head of foam, tilt the glass at a 45 degree angle until approximately 2/3 full, then straighten the glass and finish pouring beer.

**Note:** If beer does not dispense, check previous sections on regulator hookup and tapping the keg.

If your beer is running too slowly, adjust the pressure on the regulator judiciously (**DO NOT EXCEED 12 PSI**).

**Condensation on the spigot or tap is normal. It may take as much as 7-8 glasses of beer to reduce the amount of foam (Figure AD) dispensed after first tapping a keg.**



**Figure AB**



**Figure AC**

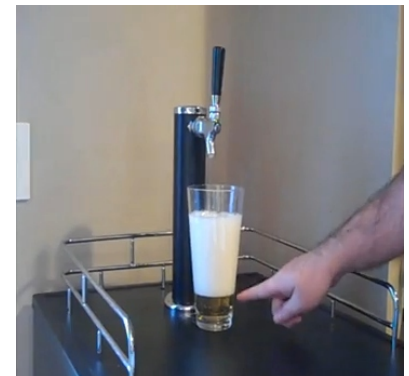

**Figure AD**

## STORING YOUR KEGERATOR

1. To prevent ice buildup on the inside of the cabinet, set the temperature control to MID or LOW if you live in a cold area. This unit does not self-defrost. The temperature control is located inside the kegerator cabinet.
2. If you do not anticipate the use of your kegerator with a tapped keg for a period of two weeks or longer, rinse the beer line to prevent mold or bacterial buildup which could cause illness.
3. Never use sharp objects in your kegerator. If you are storing your machine, be sure to prevent children from playing in or around the unit.

**DANGER!** Children can become trapped in an unsecured and unsupervised environment.

# MAINTENANCE & STORAGE

## CLEANING & MAINTENANCE

To clean the lines and tap, first:

1. **TURN OFF CO2.**
2. Next, wipe the outside of the kegerator, clean drip tray and around guardrail. Clean the inside of the cabinet by wiping with a damp cloth. Clean gasket on door to help eliminate trapped, spilled beer which could produce mold and mildew.
3. Disconnect the beer hose from the tap coupler and twist dispenser faucet carefully off the top of the kegerator.
4. Set the dispenser handle to the open or down position before flushing, then position the faucet over a sink and hold the beer line under running water for approximately 5 minutes, allowing the water to flush out the faucet head. This will also help eliminate trapped, spilled beer which could produce mold and mildew.
5. Reconnect beer line and dispenser faucet when done or leave disconnected if you plan to store for a long period.

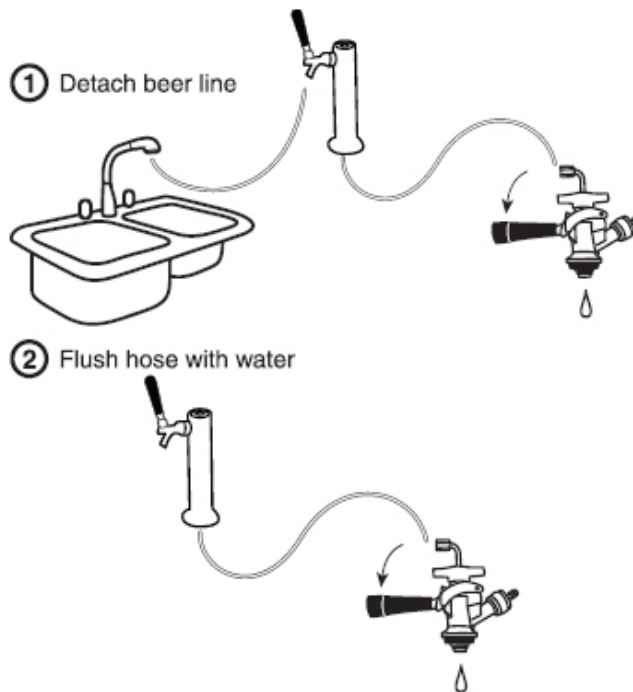

For further information, please contact [sales@greatnorthernpopcorn.com](mailto:sales@greatnorthernpopcorn.com)