





Assembly Instructions

Caution : You must read this before you proceed





Canopy Sunshade



Parts List

Label	Picture	Description	QTY
A		Cross Base Stabilizer	1PC
B		Upward Steel Cross Base	1PC
C		Downward Steel Cross Base	1PC
D		Base Pole	1PC
E		Canopy Sunshade (with preattached Curved Support Pole)	1PC

Hardware

Label	Picture	Description	QTY
①		Bolt(M8X45MM)	3PCS
②		Bolt(M8X17MM)	3PCS
③		Washer	5PCS
④		Screw With Acrylic Cap	1PC
⑤		Wrench	1PC

Assembly Preparation

Before Beginning Assembly:

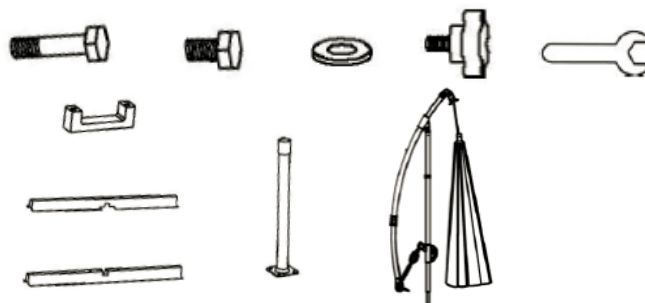

- Read instructions, cover to cover-



- Have 2 adults on hand for assembly-



- Do not assemble on flooring or carpet-



- Assemble on a clean non-marring surface (packing foam)-



- Save all packaging until finished-

Assembly Steps

Overview

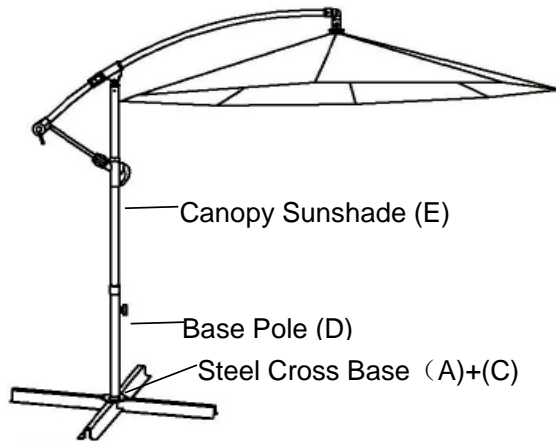

FRONT FACING

This Canopy Sunshade has multiple parts and may require up to some 30 minutes to assemble. To give you an overview of the Canopy Sunshade parts, the above picture is to help you put the various parts into perspective. Please read through the instructions below to familiarise yourself with the parts and steps before assembly.

Step 1

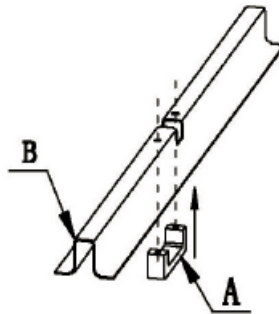

Place the Cross Base Stabilizer(A) under the Upward Steel Cross Base(B) and align the mounting positions of each. Caution: Some parts are heavy and awkward, take care of your safety and have an adult helper.

Step 2

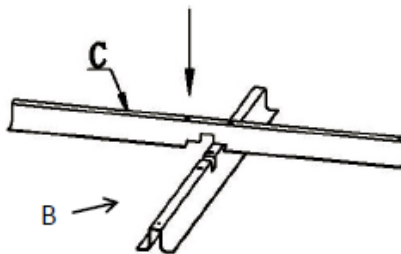

Put the Downward Steel Cross Base(C) on Upward Steel Cross Base(B) and intersect at the notches.

Step 3

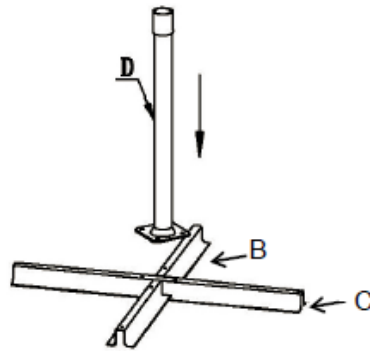

Align the mounting positions of the Base Pole(D) with Upward Steel Cross Base(B) and Downward Steel Cross Base(C).

Step 4

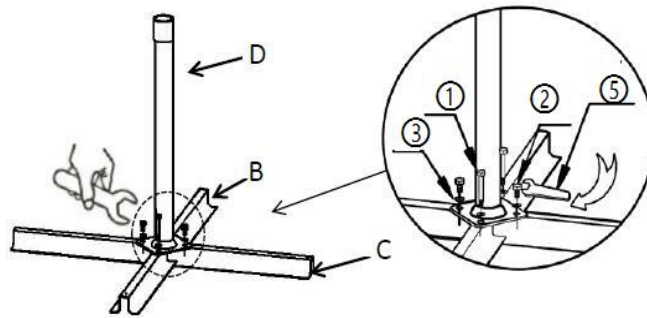

Attach the Base Pole(D) and Steel Cross Base(B) using Washers(E) and Bolts(F) with Wrench(J) and Base Pole (D) to Steel Cross Base(C) using Washers(E) and Bolts(G) with Wrench(J).

Note: Make sure all four bolts are in place before tightening completely, in a sequential manner.

Step 5

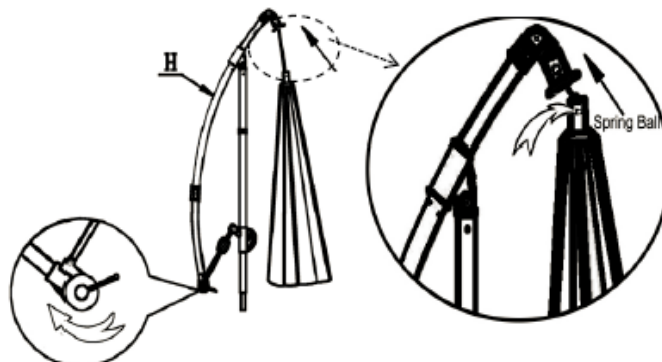

Reel-in the Canopy Sunshade by rotating the Crank clockwise until it touches the Frame. Press the Spring Ball on the Canopy and insert the Canopy into the Frame. Rotate the Canopy until the Spring Ball snaps into the mounting position of Frame.

Step 6

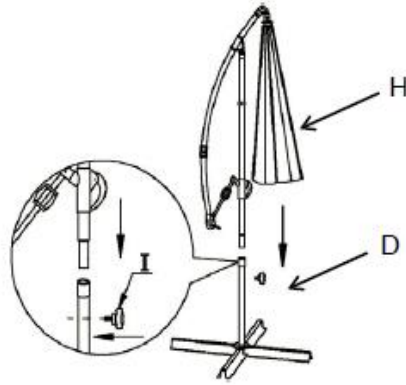

Insert the pole of the Canopy Sunshade(H) into the Base Pole(D) aligning the mounting positions of (H) and (D). Screw in by hand the Screw With Acrylic Cap(I) in the mounting positions of (H) and (D) to ensure that the pole is tightly secured to the base. Your Canopy Sunshade is fully assembled. Caution: It is recommended that weights ($\geq 45\text{kg}$), be placed at the base to achieve stability during use of the Canopy Sunshade.

Operation Steps

Step 1

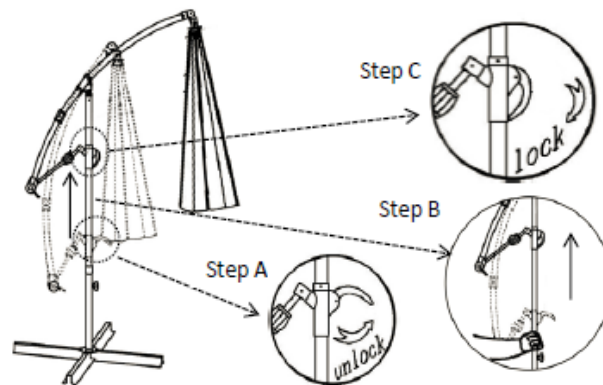

To use the Canopy Sunshade, you need to apply a 3 step process. These are: Step A - First push the lever of the Hand Grip upwards to unlock the Curved Support Pole. Step B - Then slide the Hand Grip upwards along the pole about one meter above the ground. Step C - To lock, pull down the lever of the Hand Grip to lock onto the Curved Support Pole into position.

Step 2

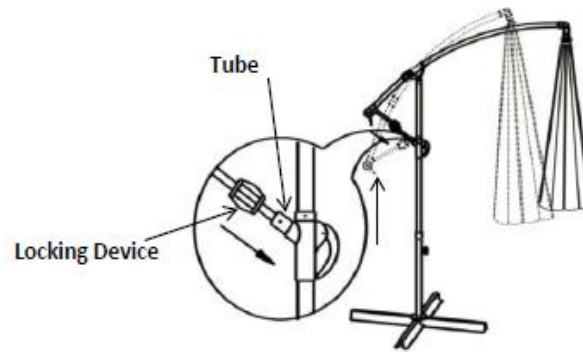

Push the Bend Pole upwards until it is aligned to the Tube. Push down the Locking Device until it covers the Tube. This action locks the Curved Support Pole in position.

Step 3



Open the Canopy Sunshade by rotating the Crank clockwise. To close, rotate the Crank counterclockwise.



















Step 4



Your Canopy Sunshade is ready for use. **Caution:** Always close the Canopy Sunshade when not in use and never use the Canopy Sunshade during strong windy conditions.

Caution: The Canopy Sunshade can only be used on a flat, level surface.

Care & Maintenance

-   ● Do not put hot items directly on furniture surface
 -   ● Do not clean furniture with harsh cleansers or polish.
 -   ● To obtain the longest lifespan of your outdoor products, minimizing exposure to direct sunlight is recommended.
 -   ● Children should not climb or jump on the furniture.
 -   ● Do not write on furniture without a padded barrier to protect the surface.
 -   ● To obtain the longest lifespan of your outdoor products, avoid extended and lengthy exposure to rain, snow, and direct sunshine. Whenever possible cover the product and /or place under patio or awnings.
 -   ● Not for commercial use. For residential use only .
 -   ● Stains may be removed with mild soap solution and damp cloth.
-
-   ● Dust and pick-up spills using a clean, non-colored, lint-free cloth .

What is Proposition 65?

Proposition 65 is a California law that requires warning labels on products that may contain one of more than 800-plus chemicals or ingredients that the California Office of Environmental Health Hazard Assessment (OEHHA) has deemed to cause cancer or other reproductive toxicity. Chemicals and elements on this list include wood dust, brass, and other everyday substances, which can be found in very common household items, such as: lamps, tableware, jewelry, crystal glasses, electric cords, beauty products, automobiles, and furniture.

Why Did I Find a Proposition 65 Warning on My Home Goods Product?

We include Proposition 65 warnings on all of our products because there is always a chance that one of the 800-plus common chemicals and ingredients listed under this law could potentially be on our furniture or packing materials. We risk large fines under this law, if we don't include this warning.

Should I worry?

We realize you may be worried finding this warning on our products, but we want to reassure you that the hazardous exposure limits for any of these chemicals have never been found on furniture products that we've shipped to our customers. Additionally, this warning label is very common and can be found on almost every piece of furniture sold in the state of California.

Just How Common Are Proposition 65 Warnings?

Proposition 65 warnings have become so common in California that it is hard to take a trip to a local bank, grocery store, or restaurant without finding at least one warning. In fact, even the Disney Land Resort has a Proposition 65 warning:

