

White-Rodgers™

Universal Thermostat

with **7 DAY** scheduling

Install Guide

Want to install the easy way?

EASY DIY **W** INSTALL
W IZARD

Go to **thermostatwizard.com**

Model # UP310
Made in China

37-7577B

GUIDE CONTENTS

Preparations	3
Thermostat details	5
Removal of your old thermostat.....	8
Mounting, wiring, and configuring your new thermostat	15
Checking thermostat operation.....	22
Using your thermostat	24
Specifications	30
Troubleshooting	31



WARNING

Failure to follow and read all instructions carefully before installing or operating this control could cause personal injury and/or property damage.

1. PREPARATIONS

Precautions

- Do not exceed the specification ratings.
- All wiring must conform to local and national electrical codes and ordinances.

1.1 Check package contents

This package should contain the following items:

- Thermostat
- Mounting screws and wall anchors (x2)
- 2 AA batteries
- Terminal wire label stickers
- Installation instructions

1.2 Gather tools

Required tools:

- Small Phillips or Flat-head screwdriver
- Small pliers (needle-nose)
- Drill with 3/16" (4 mm) bit

Optional tools:

- Wire cutters/stripper
- Hammer (for wall anchors)

2. THERMOSTAT DETAILS

The thermostat buttons and switches

- ① Fan button
- ② Hold a permanent temperature, or release the hold to return to the programmed schedule
- ③ System button
- ④ Backlight button
- ⑤ Raises temperature setting
- ⑥ Access menu options
- ⑦ Lowers temperature setting

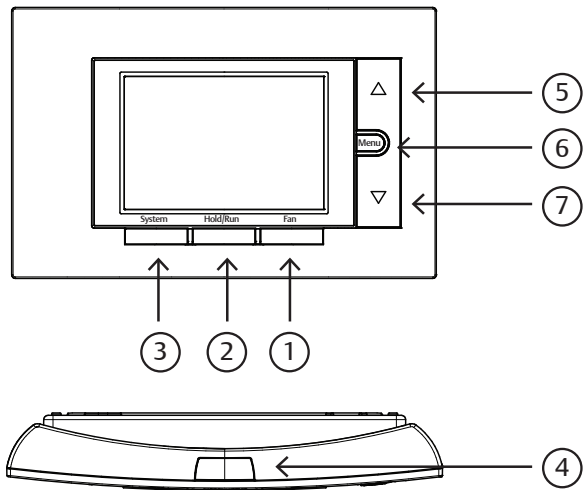

The display

- ① Next (Menu button) is used to navigate within a menu
- ② Set the correct time, access the schedule and customize thermostat settings.
- ③ Back (Fan button) is used to navigate within a menu
- ④ Exit (Hold/Run button) returns to the home screen
- ⑤ Thermostat is protecting the equipment from short cycling (5-minute delay)
- ⑥ Indicates that the system is running in Cool, Heat or Auxiliary mode. (Heat Pump Only -The auxiliary will run in Heat mode when the heat pump cannot maintain the set temperature.)
- ⑦ SEE TROUBLESHOOTING
- ⑧ Battery status indicator
- ⑨ Replace battery indicator
- ⑩ Day of the week used when programming a schedule
- ⑪ Permanent hold (bypassing the schedule)
- ⑫ Temperature setpoint
- ⑬ Appears when the keypad is locked (to prevent unwanted changes)

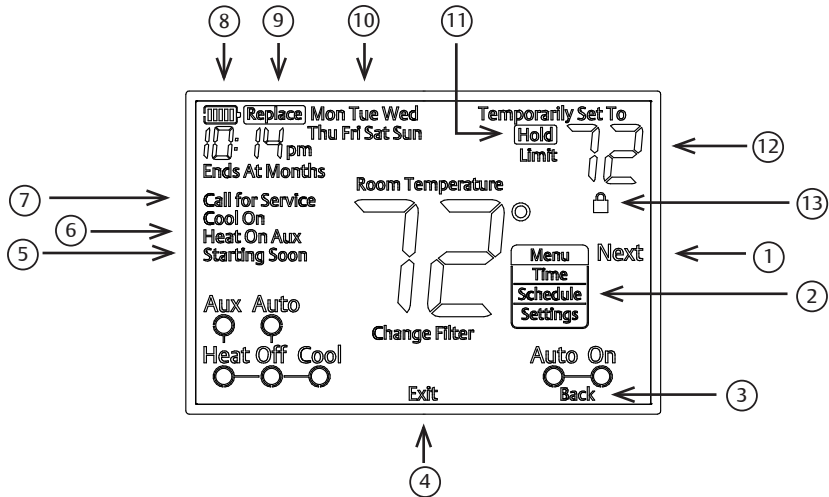

3. REMOVING OLD THERMOSTAT

3.1 Turn off power

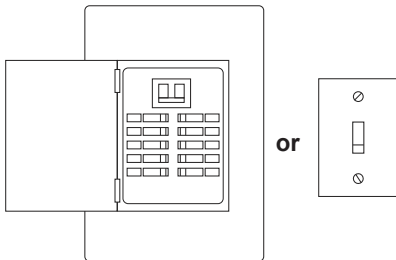

⚠ WARNING

To prevent electrical shock and/or equipment damage, disconnect electrical power to the system at the main fuse or circuit breaker box, or by flipping a switch at the air handler. Do not restore power until installation is complete.

To ensure the power to your heating and cooling system has been turned off, try to turn on heating or cooling by changing the temperature on your old thermostat.

3.2 Remove the old thermostat cover

Remove the old thermostat's front cover from the wall base. Some covers pull off easily, while others may need to be released by using a screwdriver.

CAUTION

Your old thermostat may have a sealed glass tube containing mercury. Be careful not to damage the tube or dispose of the tube in your trash. For safe disposal information, please see Mercury Notice on page 36.

3.3 Label wires

Tip: Taking a picture with a camera or smartphone can help you not only remember how wires are connected to the terminals, but can also ensure that you label your wires correctly. Mislabeling the wires may result in a high energy bill or damage to your heating and cooling system.

For each wire that comes out of wall, follow these 4 steps.

Note that this step is very important for configuring your system in section 4.5. Please follow instruction carefully.

1. Locate the terminal letter that the wire is connected to in the first column of the table
2. Write down the old thermostat terminal letter in the second column

3. Label that wire with the corresponding letter in the third column
4. Disconnect the labeled wire carefully, and proceed to the next wire until all wires are labeled

Please note that not all terminals may be used and that there's no standard color code for thermostat wires, so your wire colors may vary. For your reference, we've included a terminal label reference chart below to help you connect the wires from your old thermostat to your new thermostat in case you get stuck.

Terminal labeling reference chart

If your current terminal has the following letter	Write down that letter here	Label the wires with the following letters	Terminal function
RH, R, R5, 5		RH	24V Power (Heating)
RC		RC	24V Power (Cooling)
C, X, B*		C	Common Wire
W, W1, W/E, Aux/E, E		W/E	1st Stage Heat (for conventional system); 1st Stage Auxiliary Heat (for heat pump system)

Terminal labeling reference chart, cont'd.

If your current terminal has the following letter	Write down that letter here	Label the wires with the following letters	Terminal function
W2**		W2	2nd Stage Heat (Conventional) 2nd Stage Auxiliary Heat (Heat Pump)
Y, Y1		Y	1st Stage Compressor
Y2		Y2	2nd Stage compressor
G		G	Fan Relay
O, B*, O/B		O/B	Reversing Valve (for heat pump systems)
L		L	Heat Pump Diagnostic

Do you have a “B” wire?

Labeling the “B” wire can be tricky. It could be labeled as “C” or “O/B” depending on whether you have an “O” wire connected to your old thermostat. Please pay attention and follow the asterisk (*) comments below while labeling.

* Label “B” as “C” only if the old thermostat also had a wire in the “O” terminal block. If there was no wire in the “O” terminal block, label the wire as “O/B”

** On heat pump systems with separate W2 and E wires, label both wires W/E (2 wires on one terminal)

3.4 Identify jumper wire

For terminal RC and RH:

On your old thermostat, if...	Then, on your new thermostat...
Terminal RC and RH are connected with a jumper wire	Leave the RC/RH jumper wire in its place
There's only one R wire (RC, RH, R or R5) coming out of the wall	Leave the RC/RH jumper wire in its place
Two separate R wires come out of the wall, and they are NOT connected by a jumper wire	Clip the jumper wire between RC and RH on the back of the new thermostat

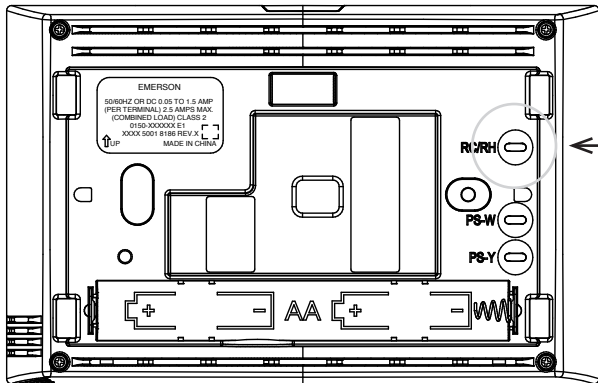

← **RC/RH Jumper Wire**

3.5 Remove old thermostat base

With all of your wires disconnected and properly labeled, you may now safely remove the thermostat base from your wall.

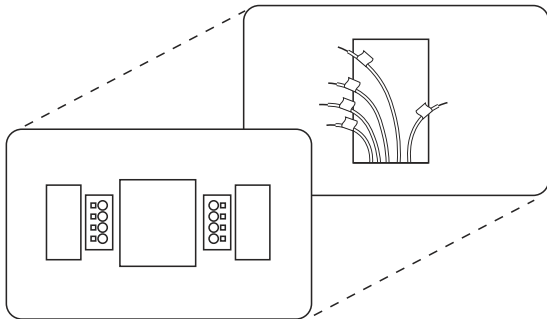

Tip: Worried about having your wires falling into your wall? Keep the wires secure by wrapping the them around a pencil.

4. MOUNTING AND WIRING YOUR NEW THERMOSTAT

4.1 Install new thermostat base

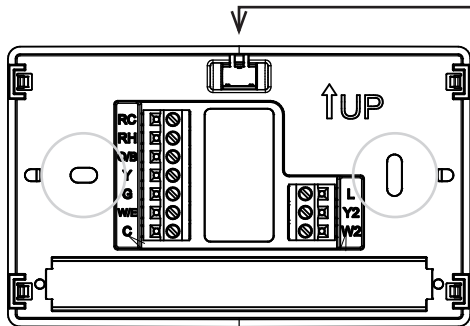

Leveling Thermostat

Leveling is for appearance only and will not affect thermostat operation.

Mount your new thermostat base using the supplied screws. Drill holes and insert wall anchors to secure the thermostat base to the wall, if necessary.

4.2 Connect wires to corresponding terminal blocks

Match each labeled wire to its corresponding terminal on the mounted thermostat base. Insert each labeled wire into the hole of its matching terminal, and using the screwdriver, tighten the screw on the terminal block securely.

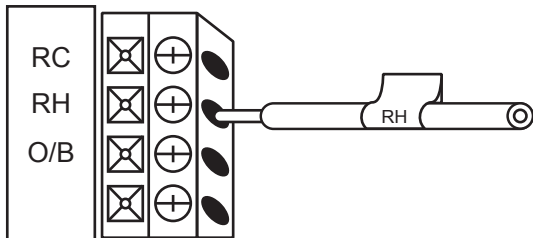

CAUTION

Take care when securing and routing wires so they do not short to adjacent terminals or rear of thermostat. Personal injury and/or property damage may occur.

4.3 Identify system configuration

Your wiring can help to determine the type of heating and cooling equipment installed in your home. Before attaching the front cover, use the following chart, and check the box next to the settings that match your new thermostat's wiring. This information will be used in **Step 4.5** to configure your thermostat.

	Thermostat Terminals with attached wires	Outdoor Equipment	Setting (Used in 4.5)
<input type="checkbox"/>	No wire on thermostat terminal Y	No air conditioner / no heat pump	AC0
<input type="checkbox"/>	Y (no O/B)	Single stage air conditioner	AC1
<input type="checkbox"/>	Y, Y2 (no O/B)	Two stage air conditioner	AC2
<input type="checkbox"/>	Y, O/B	Single stage heat pump	HP1
<input type="checkbox"/>	Y, Y2, O/B	Two stage heat pump	HP2

	Thermostat Terminals with attached wires	Indoor Equipment	Setting (Used in 4.5)
<input type="checkbox"/>	No wire on thermostat terminal W/E	Blower only (no indoor heating equipment)	FAN
<input type="checkbox"/>	W/E (Gas or Oil heat)	Single stage gas or oil furnace	GA1
<input type="checkbox"/>	W/E, W2 (Gas or Oil heat)	Two stage gas or oil furnace	GA2
<input type="checkbox"/>	W/E (Electric heat)	Single stage electric furnace	EL1
<input type="checkbox"/>	W/E, W2 (Electric heat)	Two stage electric furnace	EL2

4.4 Install the batteries and attach front cover

Install the included AA alkaline batteries and push the front cover on to the thermostat base until it's secure.

⚠ CAUTION

Do not restore power to the heating and cooling system until instructed.

4.5 Configure thermostat

Hold the menu button down for 8 seconds to launch the installer menu. Your screen will change to the configuration menu. Set the first 3 items (05, 10, 15) to match your equipment. Please refer to the table in **Section 4.3** and **Section 3.3** to find out your equipment type and previous wiring configuration.

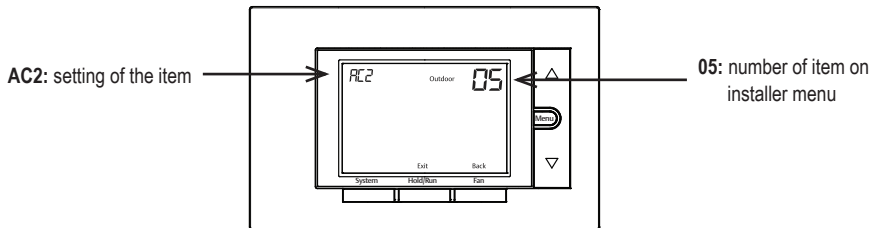

Menu # (Hold Menu 8 Seconds)	Description	Default Setting (flashing icons)	Settings (Press ▲ or ▼)
05	Outdoor Equipment: selects air conditioner (AC) or heat pump (HP) equipment as well as the number of stage	AC2	AC0 AC1 AC2 HP1 HP2 Refer to Section 4.3
10	Indoor Equipment: selects whether the equipment is a gas furnace, electric furnace or fan only	EL2	FAN GA1 GA2 EL1 EL2 Refer to Section 4.3
20 R	Reversing valve set to O or B * * For heat pump systems only	O	O if old thermostat has an O terminal B if old thermostat has a B terminal
30 CR	Heat Cycle Rate: how often the heat will turn on	MEd	SLO – slow MEd – medium FAS – fast

Menu # (Hold Menu 8 Seconds)	Description	Default Setting (flashing icons)	Settings (Press ▲ or ▼)
32 CR	Aux Cycle Rate: how often the auxiliary heat will turn on	MEd	SLO – slow MEd – medium FAS – fast
35 CR	Cool Cycle Rate: how often the cooling will turn on	MEd	SLO – slow MEd – medium FAS – fast
50 CL	Compressor Lockout: protects the compressor from short cycling	OFF	On – 5 minute delay OFF – no delay
65	Max Heat Limit: maximum set point for heat mode	99	47 to 99
66	Minimum Cool Limit: minimum set point for cool mode	45	45 to 97

* Setting the reversing valve to “O” or “B” is necessary for heat pump systems only. Please refer to the chart in **section 3.3** for your old thermostat’s wiring.

On your **OLD** thermostat

- if you had a wire connected to “O” terminal, set reversing valve (menu # 20) valve as “O” at this step.
- if you had a wire connected to “B” terminal (and at the same time, no wire was connected to “O”), set reversing valve as “B” at this step
- if you had a wire connected to “O/B” terminal, please call Customer Support at 877.654.9394.

4.6 Turn on power

Turn on your power at the source.

Congratulations! You've completed the thermostat installation process.

5. CHECK THERMOSTAT OPERATION

Tip: If at any time during testing your system does not operate properly, please contact Customer Support at 877.654.9394 or email wr.techsupport@emerson.com

5.1 Fan operation

If your system **does not** have a **G** terminal connection, skip to **5.2 Heating system**.

1. Press the fan button to select the **ON** position. The blower should begin to operate.
2. Press the fan button to select the **AUTO** position. The blower should stop immediately.

5.2 Heating system

1. Press the **System** button to select the **Heat** position.
2. Press ▲ to adjust thermostat setting to 1° above room temperature. The heating system should begin to operate and the thermostat will indicate **Heat On**.
3. For heat pump with auxiliary- Press ▲ to adjust thermostat setting to 3° above room temperature. The auxiliary heat should begin to operate and the thermostat will indicate **Heat On Auxiliary**.
4. Press ▼ to adjust thermostat setting below room temperature. The heating system should stop operating and the **Heat On** icon will disappear.

5.3 Auxiliary only mode (heat pump systems)

1. Press the system button to select the **Aux** position. This bypasses the heat pump and runs **auxiliary heat only**.
2. Press ▲ to adjust thermostat setting to above room temperature. The auxiliary heating system should begin to operate and the thermostat will indicate **Heat On Aux**.
3. Press ▼ to adjust thermostat setting below room temperature. The auxiliary heating system should stop operating and the **Heat On Aux** icon will disappear.

5.4 Cooling system



1. Press the system button to select the **Cool** position.
2. Press ▼ to adjust thermostat setting 1° below room temperature. The blower should come on immediately on high speed, followed by cold air circulation. The thermostat will indicate **Cool On**. There can be up to a 5 minute delay. (see INSTALLER MENU, item 50)
3. Press ▲ to adjust thermostat setting to 1° above room temperature. The cooling system should stop operating and the **Cool On** icon will disappear.

6. USING YOUR THERMOSTAT

6.1 User menu

To customize thermostat settings, press the **Menu** button from the home screen. Use the ▲ or ▼ buttons to highlight **Settings** and press **Next**. Use **Next** and **Back** to navigate through menu items. Press ▲ or ▼ to change the setting.

User Menu (Press Menu button and release)	Description	Default Setting (flashing icons)	Settings (Press ▲ or ▼)
01	Schedule Type: set as either 7-Day, 5-1-1 Day or Non Programmable	5	7 – 7 Day 5 – 5-1-1 Day 0 – Non-Programmable
02 E	Early Start: starts heating or cooling early so your programmed temperature is reached by the programmed time	OFF	On – start early OFF – start at program period time
03	Fahrenheit or Celsius	°F	°F – Fahrenheit °C – Celsius
04	Temperature Display Adjustment: adjust the Room Temperature)	0	-5 to +5

User Menu (Press Menu button and release)	Description	Default Setting (flashing icons)	Settings (Press ▲ or ▼)
05 	Continuous Display Light: keep the backlight always on – “C” wire required	OFF	On – always on OFF – momentarily
06	Change Air Filter: set up a monthly reminder	OFF	1 to 12 – reminder time months) OFF – no filter reminder
07	Auto-Changeover: thermostat automatically switches between heat and cool	OFF	On - enable auto OFF - disable auto
08 	Keypad Lock: prevent unwanted changes to the thermostat	OFF	On – disable buttons OFF – all buttons are active

6.2 Thermostat operation

Set Current Time and Day

Note: Time icons will flash at initial power up or after a reset.

1. Press **Menu**
2. The time icon will be flashing, Press **Next** to advance and set the time
3. Use ▲ or ▼ to set the correct time
4. Press **Next** and use ▲ or ▼ to set the correct day
5. Press **Exit** when finished.

The default program is **5-1-1 Day**, but can be setup as a **7-Day** or **Non-Programmable** thermostat (refer to the **User Menu** on pages 25-26)

- **Hold Temperature (bypassing the schedule)** – With the **System** set to **Heat** or **Cool**, momentarily press the **Hold/Run** button. **Hold** will be displayed. Use ▲ or ▼ to adjust the temperature. The thermostat will hold the room temperature at the selected setting until you press **Hold/Run** again to start program operation (cancels permanent Hold).

- **Program Override (Temporary Hold)** – Press ▲ or ▼ until the desired temperature is displayed. The thermostat will override the schedule until the next programmed time period with a minimum override of 2 hours. Then the thermostat will automatically revert to the program.
- **Keypad Lockout** – To prevent unwanted changes, the buttons can be disabled. To turn this feature On, press and hold ▲ and the **Menu** button until the  icon appears (this can also be turned on in the menu). To turn Off, press and hold ▲ and the **Menu** button for 3 seconds.

6.3 Thermostat schedule

Energy Saving Factory Schedule

This thermostat is programmed with the energy saving settings shown in the table below for all days of the week.

	Wake	Leave	Return	Sleep
Heating Schedule	6:00 AM - 70°F	8:00 AM - 62°F	5:00 PM - 70°F	10:00 PM - 62°F
Cooling Schedule	6:00 AM - 75°F	8:00 AM - 83°F	5:00 PM - 75°F	10:00 PM - 78°F

Note: Thermostat can be programmed on or off the subbase

Modify the Heating Schedule

1. Use the System button to select **Heat**
2. Press **Menu**
3. Use the ▲ button to select **Schedule** and press **Next** to enter the schedule
4. The time icons will flash – use ▲ or ▼ to set the time for the start of a period
5. Press **Next** – the set point icons will flash – use ▲ or ▼ to set the temperature for the current period
6. Continue to press **Next** to advance through all periods (Wake, Leave, Return, Sleep) for all days of the week.

Note: Press **Back** to return to the previous setting. Once all days of the week have been programmed the thermostat will display **End**. Press **Exit** at any time to save changes and return to home screen.

Modify the Cooling Schedule

1. Use the **System** button to select **Cool**
2. Repeat steps 2-6 from the heating schedule

7. SPECIFICATIONS

Electrical Rating:

Battery Power	mV to 30 VAC, NEC Class II, 50/60 Hz or DC		
Input-Hardwire	20 to 30 VAC, NEC Class II, 50/60 Hz		
Terminal Load	1.5 A per terminal, 2.5A maximum all terminals combined		
Setpoint Range	45° to 99° F (7° to 37° C)		
Rated Differentials (@ 6°F/ Hr):	Fast	Med	Slow
Heat (Conventional Gas / Oil / Elect)..	0.5°F	0.75°F	1.9°F
Cool (Central Air)	0.9°F	1.2°F	1.7°F
Heat Pump (Heat and Cool)	0.9°F	1.2°F	1.7°F
Heat Pump Aux.....	0.5°F	0.75°F	1.9°F
Operating Ambient.....	32°F to +105°F (0° to +41°C)		
Display Temperature Range	32°F to +99°F (0 to 37°C)		
Operating Humidity.....	90% non-condensing maximum		
Shipping Temperature Range.....	-20°F to + 150°F (-29° to +65°C)		
Thermostat Dimensions.....	3-3/4" H x 6" W x 1-1/8" D		

8. TROUBLESHOOTING

Symptom	Possible Cause	Corrective Action
No Heat/No Cool/No Fan (common problem)	<ol style="list-style-type: none">1. Blown fuse or tripped circuit breaker2. Furnace power switch to OFF3. Furnace blower compartment door or panel loose or not properly installed4. Loose connection to thermostat or system	<ol style="list-style-type: none">1. Replace fuse or reset breaker.2. Turn switch to ON.3. Replace door panel in proper position to engage safety interlock or door switch.4. Tighten connections
No Heat	<ol style="list-style-type: none">1. System not set to Heat2. Loose connection to thermostat or system3. Heating System requires service or thermostat requires replacement	<ol style="list-style-type: none">1. Set thermostat to Heat.2. Verify thermostat and system wires are securely attached.3. Diagnostic: Set System to Heat and raise the setpoint above room temperature. Within five minutes the thermostat should make a soft click sound and "Heat On" should appear on display.

Symptom	Possible Cause	Corrective Action
No Heat (contd.)		<p>3. (contd.) This sound indicates the thermostat is operating properly. If the thermostat does not click, try the reset operation listed below. If the thermostat does not click after being reset, contact your heating and cooling service person or place of purchase for a replacement. If the thermostat clicks, contact the furnace manufacturer or a service person to verify the heating system is operating correctly.</p>
No Cool	<ol style="list-style-type: none"> 1. System not set to Cool 2. Loose connection to thermostat or system 3. Cooling System requires service or thermostat requires replacement 	<ol style="list-style-type: none"> 1. Set thermostat to Cool. 2. Verify thermostat and system wires are securely attached. 3. Diagnostic: Set System to Cool and lower setpoint below room temperature. Same procedures as diagnostic for "No Heat" condition except set the thermostat to Cool and lower the setpoint below the room temperature. There may be up to a five minute delay before the thermostat clicks in Cooling if the compressor lock-out option is selected in the installer menu. (see INSTALLER MENU, item 50)

Symptom	Possible Cause	Corrective Action
Heat, Cool or Fan Runs Constantly.	Possible short in wiring, thermostat, heat, cool or fan system	Check each wire connection to verify they are not shorted or touching other wires. Try resetting the thermostat. If the condition persists contact your HVAC service person.
Thermostat Display & Thermometer Disagree	The location of the thermostat and/or the size of the Heating System may be influencing the cycle rate	Display can be adjusted +/-5°. See User Menu item 05
Furnace (Air Conditioner) Cycles Too Fast or Slow (narrow or wide temperature swing)	The location of the thermostat and/or the size of the Heating System may be influencing the cycle rate	Digital thermostats provide precise control and cycle faster than older mechanical models. The system turns on and off more frequently, but runs for a shorter time. If you would like to increase cycle time, choose SLO for slow cycle in the Installer menu. (Reference menu items 30, 32 & 35) If an acceptable cycle rate is not achieved, contact your HVAC service person.

Symptom	Possible Cause	Corrective Action
<p>"Call for Service" icon appears on displayed</p>	<ol style="list-style-type: none"> 1. Heating system is not able to heat the space to within 10 degrees of the setpoint within 2 hours 2. Cooling system is not able to cool the space to within 10 degrees of the setpoint within 2 hours 3. If "--" is displayed for the Room Temperature, a replacement thermostat is needed 4. None of the buttons operate on the thermostat 5. If "Call for Service" is flashing, compressor self diagnostic is detecting an issue with the outdoor unit 	<ol style="list-style-type: none"> 1. See corrective action for "No Heat" 2. See corrective action for "No Cool" 3. Replace thermostat 4. Make sure keypad lockout is not turned on (), If it's OFF, try reset shown below. 5. Contact a service person to verify the outdoor equipment is operating correctly
<p>Heat pump system runs heat in cool mode/cool in heat mode</p>	<p>Changeover "O/B" set incorrectly</p>	<p>Use configuration to switch "O" to "B" or "B" to "O"</p>

Resetting the Thermostat or Thermostat Settings

If the thermostat has good batteries, but has a blank display or does not respond to key presses, the thermostat should be reset by removing the batteries for 2 minutes. This reset will not change the menu settings or program. If the condition persists after reinstalling the batteries, replace the thermostat.

To conveniently reset only the schedule and user settings back to factory defaults, press **Menu** and **Backlight** buttons at the same time and hold until the display goes blank and resets.

CONTACT US

Customer support: 877.654.9394 or wr.techsupport@emerson.com

MERCURY NOTICE

This product does not contain mercury. However, this product may replace a product that contains mercury.

Mercury and products containing mercury must not be discarded in household trash.

Refer to thermostat-recycle.org for location to send product containing mercury.

FOR CALIFORNIA RESIDENTS

Warning: This product contains a chemical known to the state of California to cause cancer and birth defects and other reproductive harm.