

WW13011

HEAT  **WAVE**

Sussex Infrared Heater User Manual



SAVE THESE INSTRUCTIONS FOR FUTURE REFERENCE.

If you are assembling this unit for someone else, give this manual to him or her to read and save for future reference.



C US
INTERTEK
4001358

Allen Group Int'l Inc.
377 South Lemon Ave, Suite A
Walnut, CA USA
91789

**L2048
FEB 2014**

Call 1-877-744-3649 for assistance or email us at service@phoenixinno.com

IMPORTANT SAFETY INSTRUCTIONS

Quick Reference Guide



CAUTION: BEFORE OPERATING THIS EQUIPMENT, PLEASE READ THESE INSTRUCTIONS CAREFULLY.

READ ALL INSTRUCTIONS BEFORE USING THIS APPLIANCE

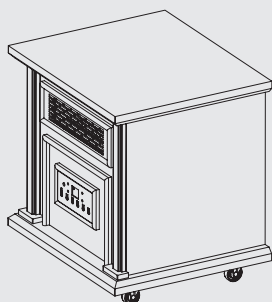

1. Before permanently placing your infrared heater, plug it into a convenient outlet to verify that the circuit breakers for the outlet are on.
2. The heater may emit a slight, harmless odor when first used. This odor is normal and is caused by the initial heating of internal heater parts and will not occur again.
3. If your electrical heater does not emit heat, consult your owner's manual for further information.



SA 1965

**CAUTION
RISK OF ELECTRICAL SHOCK
DO NOT OPEN**

**NO USER-SERVICEABLE PARTS INSIDE
HIGH TEMPERATURE**



SA 1965

KEEP DRAPERY AND OTHER FURNISHINGS AT LEAST 3 FEET / 0.9 METER FROM THE FRONT AND SIDES OF THE ELECTRICAL HEATER.

WARNING:

1. WARNING: TO REDUCE THE RISK OF FIRE – KEEP COMBUSTIBLE MATERIAL SUCH AS FURNITURE, PAPERS, CLOTHES, AND CURTAINS AT LEAST 3 FEET (0.9 M) FROM THE FRONT OF THE HEATER AND AWAY FROM THE SIDES AND REAR.
2. SERVICING SHOULD BE DONE ONLY WHILE THE ELECTRICAL HEATER IS DISCONNECTED FROM THE POWER SUPPLY.

SPECIAL CHARACTERISTICS.

- A) This heater is ideal for use all year round, even when central heating has been turned off.
- B) This heater produces a hot current of air.

UNPACKING AND INSTALLING THE ELECTRICAL HEATER.

1. Open the packaging carefully and remove the heater.
2. Remove and discard the plastic bag. Locate hardware and castor package.

	HARDWARE	
A		16PCS
B		4PCS

3. BE RESPONSIBLE HANDLING THE PACKING MATERIALS.

WARNING: KEEP PLASTIC WRAPPING AWAY FROM CHILDREN.

4. Keep the original packing for future transport and/or storage.
5. Keep the front of the unit, through which the heat is radiated, at least 3 feet / 0.9 meter away from furniture, curtains and other flammable objects / materials at all times.
6. Ensure there is a grounded socket nearby (back of the appliance).
7. The power cord must remain at the back of the appliance and must not be in contact with any hot element.

CASTOR INSTALLATION

1. Carefully turn the heater on its back onto a towel to prevent any damage. See Fig i below.
2. Mount each castor (4) in the predrilled holes. Tighten screws. See Fig ii below.
3. Carefully return the heater to its working position. See Fig iii below.

Fig. i

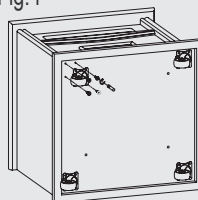

Fig. ii

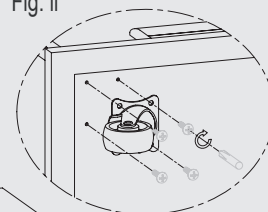
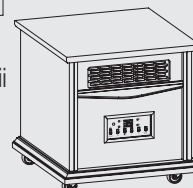

Fig. iii



IMPORTANT SAFETY INSTRUCTIONS:

WARNING: Any use of this appliance other than that recommended by the manufacturer in this owners manual may cause fire, burns, electric shock and/or other serious injuries or death.

When using electrical appliances, basic precautions should always be followed to reduce the risk of fire, electric shock and injury to persons including the following:

1. Read the manufacturers instructions completely before using this appliance.
2. This appliance will become hot when in use. To avoid burns, do not let bare skin touch hot surfaces. The grill at the top of this heater in particular will become hot when the heater is active. Keep combustible materials such as furniture, pillows, bedding, paper, cloth, curtains, etc. at least 3' (0.9m) away from the front of the appliance. Keep all items away from the sides and back of the appliance and take special care not to block the air intake or exhaust vents.
3. Extreme caution is necessary when the appliance is used by or near children or invalids and whenever the heater is left operating and unattended.
4. Do not operate the appliance if the power cord or plug has been damaged or the heater has been damaged or malfunctioned in any way. Take the appliance to an authorized service facility for examination, electrical or mechanical adjustment or repair.
5. Do not use outdoors.
6. This heater is not intended for use in bathrooms, laundry areas and similar indoor locations. Never locate heater where it may fall into a bathtub or other water container.
7. Do not run the power cord under carpeting. Do not cover the power cord with throw rugs, runners, or similar floor coverings. Take care to position the cord away from high traffic areas and such that it can not be tripped over.
8. To disconnect the appliance, turn all controls "OFF", then remove the plug from the electrical outlet. Always unplug the appliance when not in use.
9. Connect to properly grounded outlets only. The appliance comes equipped with a 3 prong grounding plug. Do not attempt to cut the grounding prong. Connect to properly grounded 120V outlets only. This appliance, when installed, must be electrically grounded in accordance with local codes or, in the absence of local codes, with the current:
 - Canada: CSA C22.1, Canadian Electrical Code
 - U.S.A.: ANSI/NFPA NO. 70, National Electrical Code
10. Do not insert or allow foreign objects to enter any ventilation or exhaust opening as this may cause an electric shock or fire, or damage the appliance.
11. To prevent a possible fire, do not block air intakes or exhausts in any manner. Do not use on soft surfaces, like a bed, where openings may become blocked.
12. All electrical heaters have hot and arcing or sparking parts inside. Do not use in areas where gasoline, paint, or flammable liquids are used or stored or where the appliance will be exposed to flammable vapors.
13. When transporting or storing the heater, take care to keep both the unit and power cord/plug dry, free from excessive vibration and away from heat sources.
14. Use the heater only as described in this manual. Any other use not recommended by the manufacturer may cause fire, electric shock, or injury to persons.
15. Always plug heaters directly into a wall outlet/receptacle. Never use with an extension cord or relocatable power tap (outlet/power strip).
16. Do not attempt to burn wood or other materials in this heater.
17. This appliance comes equipped with an overheat protection safety device. Should the appliance begin to overheat for any reason, the thermal cutout of appliance will engage and then all functions of the appliance will shut down. The appliance will have to be reset prior to continuing use. To reset the overheat protection safety device, turn all controls off, unplug the appliance for 15 minutes. Then plug the appliance back in and turn on.

SAVE THESE INSTRUCTIONS

GROUNDING INSTRUCTIONS

This product must be grounded. If it should malfunction or break down, grounding provides a path of least resistance for the electric current to reduce the risk of electric shock. This product is equipped with a cord with an equipment-grounding conductor and a grounding plug. The plug must be plugged into an appropriate outlet that is properly installed and grounded in accordance with all local codes and ordinances.

DANGER:

Improper connection of the equipment-grounding conductor can result in a risk of electric shock. Check with a qualified electrician or service technician if you provided with the product-if it will not fit the outlet, have a proper outlet installed by a qualified electrician.

This product is for use on a nominal 120V circuit and has grounding plug that looks like that plug illustrated below. Make sure that the product is connected to an outlet having the same configuration as the plug. No adapter should be used with this product.

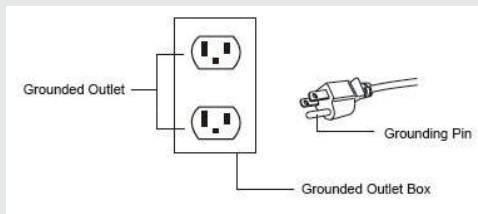

NOTE:

A 15AMP, 120 Volts circuit is required. Dedicated circuit is preferred but not essential in all cases, a dedicated circuit will be required if, after installation, the circuit breaker trips or the fuse blows on a regular basis when the heater is operating. Additional appliance on the same circuit may exceed the current rating of the circuit breakers.

WARNING:

1. Ensure the power cord is not installed so that it is pinched or against a sharp edge and ensure that the power cord is stored or secured to avoid tripping or snagging to reduce the risk of fire, electric shock or injury to persons.
2. Construction and electrical outlet wiring must comply with local building codes and other applicable regulations to reduce the risk of fire, electric shock and injury to persons.

Do not attempt to wire your own new outlets or circuits. To reduce the risk of fire, electric shock or injury to persons, always use a licensed electrician.

<p>SPECIFICATIONS</p> <p>Technical Specifications</p> <p>Model: WW13011</p> <p>Voltage: 120V</p> <p>Frequency: 60Hz</p> <p>Power: 1500W</p>

OPERATING INSTRUCTIONS:

Read all instructions and warnings prior to operating the appliance. Ensure that all controls are in the "OFF" position before plugging the appliance in to a properly grounded electrical outlet.

NOTE: Check to ensure the Master Control Power Switch is turned on. It is located on that back of the unit. See Fig 1.

The control panel of the appliance is located in the centre (See Fig. 2 and Fig. 3).

Fig. 1

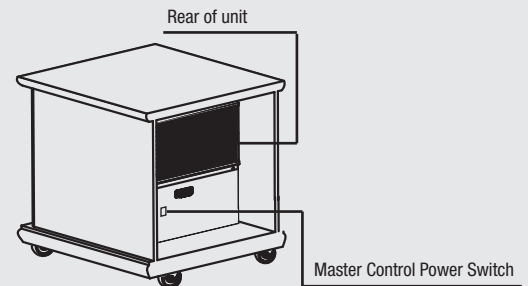

Fig. 2

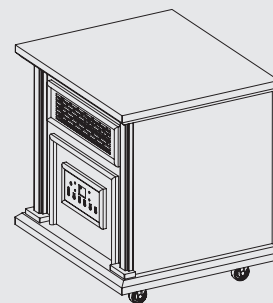
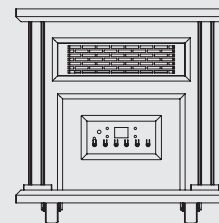

Fig. 3



When you first turn the heater on, it may emit a slight but harmless odor. This odor results from certain oils or greases being heated as the appliance is used for the first time. This odor is perfectly safe and will stop shortly – it will not reoccur after the first operation of the appliance.

OPERATING INSTRUCTIONS:

Using the Control Panel (See Fig. 3 Below):

Master Power (I/O) Switch (A):

- Push button A to turn infrared heater on. Ensure that the red power light “B” above the Master Power Switch is on - this confirms that the unit is plugged in. It will turn from red to green when the Master Power Switch is pushed.

Fan Button (C):

- This is a High and Low setting for the fan and the heater. Note that the fan will only come on if the thermostat temperature is set above the room temperature.
- The fan light (D) denotes the Low fan setting and the fan light (E) denotes the High setting.

Timer (F):

- If a timer is desired, push this button once for a 1 hour timer, twice for a 2 hour time, etc (up to 12 hours). The time will show on the digital readout screen. To reset, keep pushing the Timer button (F) until it returns to your desired time setting. (Note that the timer is approximate and extreme caution is necessary when the infrared heater is left operating and unattended. Keep children, invalids and and pets away from the unit when in use.)

Temperature Buttons - Increase (G) and Decrease (H):

- This infrared heater is equipped with a thermostat. Press the Temperature Button (G) to increase the temperature. Press the Temperature Button (H) to decrease the temperature. (The infrared heater and fan will only turn on if the temperature setting is higher than the room temperature.)

The Temperature Digital Readout Screen (I):

- This screen shows the current setting of the thermostat in Celcius or Fahrenheit degrees. See Button (L) to adjust the setting to C or F.
- Press on the “°C/°F” Button (L) on the control panel for 3 seconds and after a short “beep” sound, the displayer will show the real room temperature for 5 seconds
- This screen will turn off after 5 minutes if there is no temperature adjustments.
- The temperature light (J) indicates if the digital reading is in Fahrenheit and the temperature light (K) indicates the digital reading is in Celcius

NOTE: The fan will continue to work for several minutes when the heaters turns off. This allows the infrared components inside the heater to cool down.

Control Panel:

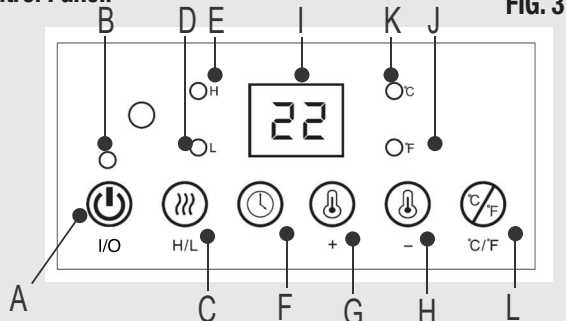

Using the Remote Control:

This heater includes a remote control. To operate the appliance using the remote control, ensure the red power light “B” is on. Each remote control is shipped with a plastic tab inserted into the battery chamber to prevent damage and power loss. Pls remove by pulling on the tab out of the chamber. (See Maintenance Section). See below for directions to use the remote control:

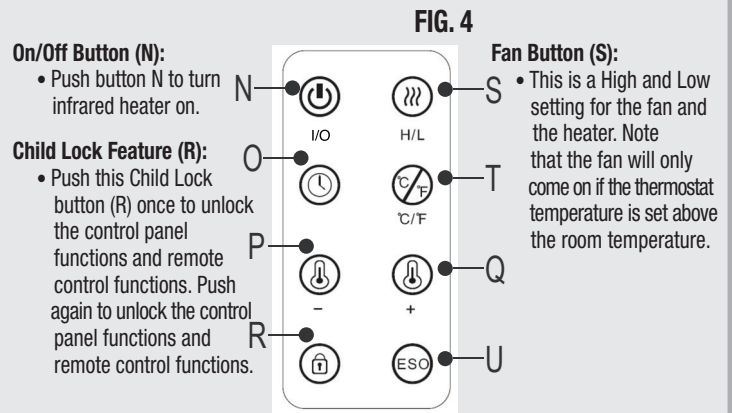

On/Off Button (N):

- Push button N to turn infrared heater on.

Child Lock Feature (R):

- Push this Child Lock button (R) once to unlock the control panel functions and remote control functions. Push again to unlock the control panel functions and remote control functions.

Fan Button (S):

- This is a High and Low setting for the fan and the heater. Note that the fan will only come on if the thermostat temperature is set above the room temperature.

NOTE: If the Remote Control is misplaced, press the Master Power (I/O) on the Control Panel for 3 seconds and the controls will unlock after a short “beep” sound.

Timer (O):

- If a timer is desired, push this button once for a 1 hour timer, twice for a 2 hour time, etc. (up to 12 hours). The time will show on the digital readout screen. To reset, keep pushing the Timer button (F) until it returns to your desired time setting. (Note that the timer is approximate and extreme caution is necessary when the heater is left operating and unattended. Keep children, invalids and pets away from the unit when in use.)

Celcius / Fahrenheit Setting Button (T):

- Push the button (T) to change the heat readout settings.

Temperature Buttons - Increase (Q) and Decrease (P):

- This infrared heater is equipped with a thermostat. Press the Temperature Button (Q) to increase the temperature. Press the Temperature Button (P) to decrease the temperature. (The infrared heater and fan will only turn on if the temperature setting is higher than the room temperature.)

ESO Button Energy Savings Option (U):

- Push this button (U) once to move the temperature setting easily to 68 degrees F (20 degrees C).
- Push the ESO Button (U) an additional time to release the appliance from the Energy Savings Option.

NOTE: Direct the remote control at the appliance from 1 to 5 meter distance for the remote control to function properly. The remote control receptor is located in the control panel (Fig 1)

NOTE: For remote control battery replacement, use Lithium Cell CR2025 3V.

MAINTENANCE:



WARNING: BEFORE CLEANING THE EXTERIOR OF THE APPLIANCE, DISCONNECT THE UNIT FROM THE POWER SUPPLY AND LEAVE UNTIL COOL.



CAUTION: DO NOT USE ABRASIVE CLEANERS ON THE GLASS PANEL. DO NOT SPRAY LIQUIDS DIRECTLY ONTO ANY SURFACE OF THE UNIT.



WARNING: AN AUTHORIZED SERVICE REPRESENTATIVE SHOULD PERFORM ANY OTHER SERVICING.

WARNING: Before attempting to perform any maintenance on this appliance, turn all controls to the "OFF" position and unplug. Allow the appliance to be "OFF" for at least 15 minutes before performing any maintenance in order to allow all components to cool properly.

Cleaning:

1. To remove dust, use clean, dry cloth.
2. Clean metal surfaces with a clean damp cloth making sure not to push dust or debris into any air intake or exhaust vents.
3. Do not use abrasive cleaners or spray liquids on any part of the appliance.
4. Periodic cleaning/vacuuming of the fan/heater unit is strongly recommended to ensure that no dirt or foreign objects build up.

Air Filter Cleaning:

1. It is suggested to clean the air filter on the back on the infrared heater on a regular basis - 1 or 2 times per season or more depending on the amount of dust in the air. Wash in soapy water.
2. See Fig. 5 and 6 for the steps to clean the air filter.

Battery Replacement:

1. For the first time use the protective plastic tab for the battery must be removed. See Fig. 7 below.
2. For remote control battery replacement, use a Lithium Cell CR2025 3V battery. See Fig. 7 and 8 below for the replacement steps

STORAGE:

Store the heater in a cool, dry location when not in use. To prevent dust and dirt build-up, use the original packaging to repack the unit.

Fig. 5

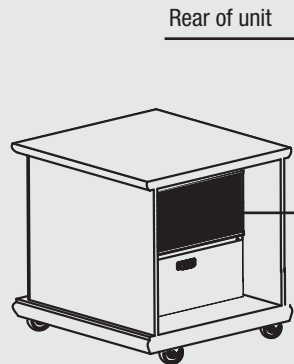
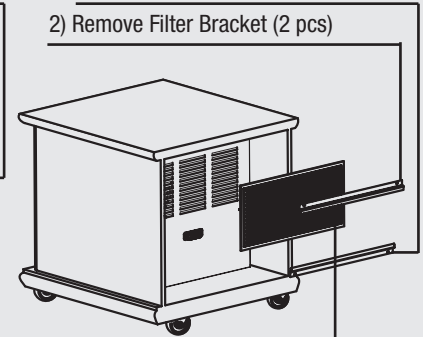

Fig. 6

- 1) Remove bracket screws (4 pcs)
- 2) Remove Filter Bracket (2 pcs)



- 3) Remove Air Filter

Fig. 7

Remove plastic tab for 1st use

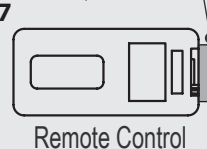

Battery

Fig. 8

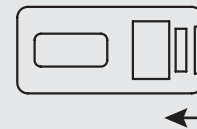

NOTE: This appliance comes equipped with an overheat protection safety device. Should the appliance begin to overheat for any reason, it will automatically turn all heater functions of the appliance off. The appliance will have to be reset prior to continuing use. To reset the overheat protection safety device, turn all controls off and unplug the appliance. Wait 15 minutes, plug the appliance back in and turn on. If the appliance continuously overheats, please call our customer service department toll free at 1-877-744-3649 or email to service@phoenixinno.com.



TROUBLESHOOTING:

WARNING: Turn off the appliance, unplug and let cool for at least 15 minutes before attempting to service. Only a qualified professional should attempt to service or repair the appliance.

IF YOU EXPERIENCE DIFFICULTIES, PLEASE DO NOT RETURN THIS PRODUCT TO STORE For assistance with this appliance, please call our customer service department toll free at 1-877-744-3649 or e-mail us at service@phoenixinno.com.

FREQUENTLY ASKED QUESTIONS (FAQS)

PROBLEM	POSSIBLE CAUSE	SOLUTION
Settings on Control Panel or Remote Control seem "LOCKED" or cannot be adjusted.	<ol style="list-style-type: none"> 1. The "Child Lock" feature (R) on the Remote Control may be activated. 2. The ESO feature (U) on the remote control may be activated. 	<ol style="list-style-type: none"> 1a. Push the "Child Lock" feature (R) on the Remote Control to unlock the controls, 1b. OR Press and hold the On/Off (I/O) button for 3 seconds on the heater Control Panel" 2. Push the "ESO" feature (U) on the remote control to unlock the controls.
The appliance turns off and will not turn back on.	<ol style="list-style-type: none"> 1. Master Control Power Switch is turned off. 2. The overheat protection device in the appliance has been triggered. 3. House circuit breaker has been tripped. 	<ol style="list-style-type: none"> 1. Turn on Master Control Power Switch which is located on the back of the unit. See Page 3 Fig. 1. 2. Turn all controls off, unplug the appliance, allow to cool for 15 minutes, plug back in and restart. 3. Reset house circuit breaker.
Remote Control does not work.	<ol style="list-style-type: none"> 1. Low Batteries. 2. Red light must be on above Master Power Switch to operate Remote Control. 	<ol style="list-style-type: none"> 1. Replace the battery in the Remote Control. See Maintenance Section. 2. Check to ensure the appliance is plugged in.
No warm air is coming from the heater.	<ol style="list-style-type: none"> 1. The overheat protection device in the appliance has been triggered. 2. Thermostat is set lower than room temperature. 	<ol style="list-style-type: none"> 1. Turn all controls off, unplug the appliance, allow to cool for 15 minutes, plug back in and restart. 2. Push temperature buttons on control panel or remote control to increase temperature.
The appliance does not turn on when the button is pushed to "ON"	<ol style="list-style-type: none"> 1. The overheat protection device in the appliance has been triggered. 	<ol style="list-style-type: none"> 1. Turn all controls off, unplug the appliance, allow to cool for 15 minutes, plug back in and restart.
Remote Control will not turn on the appliance when the power button is pushed "ON".	<ol style="list-style-type: none"> 1. The "Child Lock" feature (R) on the Remote Control may be activated. 2. Check the light (B) above the Power Switch on the control panel and ensure it is lit up (red). 3. House circuit breaker has been tripped. 	<ol style="list-style-type: none"> 1a. Push the "Child Lock" feature (R) on the Remote Control to unlock the controls, 1b. OR Press and hold the On/Off (I/O) button for 3 seconds on the heater Control Panel 2. If the light is not lit up (B) on the control panel, the appliance needs to be plugged in. 3. Reset house circuit breaker.
Digital Temperature Screen is off	<ol style="list-style-type: none"> 1. There has been no temperature adjustments for over 5 minutes. 	<ol style="list-style-type: none"> 1. Push Temperature Buttons on the Control Panel or Remote Control to light up.

Call 1-877-744-3649 for assistance or email us at service@phoenixinno.com

1 YEAR LIMITED WARRANTY:

Each and every product that we manufacture is tested prior to being shipped to retail stores. However, certain damages can sometimes occur during transportation. The following non-transferable limited warranty is extended only to the original consumer-purchaser of this Allen Group Int'l Inc. (A.G.I.) product. This product is only warranted against defects in material and workmanship subject to the normal and reasonable use and correct assembly (if assembled by the consumer-purchaser) of the product for a period of one (1) year from the date of purchase.

This warranty does not apply to the normal wear and tear or to any failures or operating difficulties due to accidental damage, abuse, misuse, alteration, misapplication, careless handling, improper installation, improper maintenance or to products used commercially. This warranty does not cover light bulbs. The duration of all implied warranties on this particular purpose are limited to the one (1) year duration of the express warranty period specified above. In no event will A.G.I. be liable for any incidental or consequential damages (including loss of profits) arising from the use of this product. Some jurisdictions do not allow limitations on how long an implied warranty lasts / or do not allow the limitation or exclusion of incidental or consequential damages, so these implied warranty limitations may not apply to you. This limited warranty gives you specific legal rights. You may also have other rights which vary from jurisdiction to jurisdiction. Repair or replacement, at A.G.I.'s option, of a defective product is your sole remedy under this limited warranty. In no event will A.G.I.'s maximum liability exceed the purchase price of the product paid by the consumer-purchaser.

Any legal action taken as a result of any alleged breach of this limited warranty or arising out of any use of this product must be commenced in the State of California. A.G.I. makes no other additional warranties express or implied with respect to this product or its component parts except those express limited warranties described above. No dealer of this product nor any retail establishment selling this product has any authority to make any warranties or to promise remedies in addition to or inconsistent with those stated above. If replacement parts are needed or to obtain performance of any obligation under this limited warranty, phone A.G.I.'s Customer Service Department toll free at 1-877-744-3649, or write to Allen Group Int'l Inc. Attention: Customer Service Department 377 South Lemon Ave. Suite A. Walnut CA. USA 91789

Be prepared to provide evidence of purchase date and proof of purchase, model number of your A.G.I. product, part number and defective part. You must pay all expenses incurred in obtaining performance of any obligation under this limited warranty, including transportation, postage, and other incidental service costs. If defective part or parts are requested by Customer Service Department, you must make the product available to us free and clear of all liens and other encumbrances. A.G.I. reserves the right to change prices, specifications and designs and to discontinue models without notice and without incurring obligations.

NOTES / NOTAS: