	Installation Instructions Laminate Click-Lock Flooring For Assistance, Call: 1-877-630-1800 Homedepot.com/homedecorators	Product Description 12 mm High Gloss Bramber Water Resistant Laminate Flooring	Grade Levels Above Grade / On Grade Below Grade	Installation Method Floating 48 hours Acclimation	Model # HL1349 Item # 1004 812 026
---	---	--	--	--	---

MANUFACTURER'S REQUIRED MINNESOTA DISCLOSURE -IMPORTANT HEALTH NOTICE: SOME OF THE BUILDING MATERIALS USED IN THIS HOME (OR THESE BUILDING MATERIALS) EMIT FORMALDEHYDE. EYE, NOSE, AND THROAT IRRITATION, HEADACHE, NAUSEA AND A VARIETY OF ASTHMA-LIKE SYMPTOMS, INCLUDING SHORTNESS OF BREATH, HAVE BEEN REPORTED AS A RESULT OF FORMALDEHYDE EXPOSURE. ELDERLY PERSONS AND YOUNG CHILDREN, AS WELL AS ANYONE WITH A HISTORY OF ASTHMA, ALLERGIES, OR LUNG PROBLEMS, MAY BE AT GREATER RISK. RESEARCH IS CONTINUING ON THE POSSIBLE LONG-TERM EFFECTS OF EXPOSURE TO FORMALDEHYDE. REDUCED VENTILATION MAY ALLOW FORMALDEHYDE AND OTHER CONTAMINANTS TO ACCUMULATE IN THE INDOOR AIR. HIGH INDOOR TEMPERATURES AND HUMIDITY RAISE FORMALDEHYDE LEVELS. WHEN A HOME IS TO BE LOCATED IN AREAS SUBJECT TO EXTREME SUMMER TEMPERATURES, AN AIR-CONDITIONING SYSTEM CAN BE USED TO CONTROL INDOOR TEMPERATURE LEVELS. OTHER MEANS OF CONTROLLED MECHANICAL VENTILATION CAN BE USED TO REDUCE LEVELS OF FORMALDEHYDE AND OTHER INDOOR AIR CONTAMINANTS.

IF YOU HAVE ANY QUESTIONS REGARDING THE HEALTH EFFECTS OF FORMALDEHYDE, CONSULT YOUR DOCTOR OR LOCAL HEALTH DEPARTMENT

WARNING: This product can expose you to formaldehyde gas which is known to the State of California to cause cancer. For more information go to www.P65Warnings.ca.gov.

WARNING: Drilling, sawing, sanding or machining wood products can expose you to wood dust, a substance known to the State of California to cause cancer. Avoid inhaling wood dust or use a dust mask or other safeguards for personal protection. For more information go to www.P65Warnings.ca.gov/wood

CAUTION: ASBESTOS IN EXISTING FLOOR: Home Decorators Collection product does not contain asbestos. Existing installed resilient flooring and asphaltic adhesive may contain asbestos fillers or crystalline silica. Do not sand, dry sweep, dry scrape, drill, saw, bead-blast, or mechanically chip or pulverize existing resilient flooring, backing, lining felt, asphaltic "cutback" adhesive or other adhesive. See "Recommended Work Practices for Removal of Resilient Floor Coverings" (rfci.com) for detailed information and instructions on removing all resilient covering structures.

Safety and Health Precautions

Power tools can be dangerous. Operate in strict accordance to manufacturer's operating instructions and safety precautions. Unsafe and improper use can cause serious injuries. Avoid inhalation and exposures to wood dust by mechanical means and by wearing personal protective equipment. Wear appropriate personal protective equipment (PPE) which includes NIOSH or OSHA-approved dust masks, safety goggles and work gloves.

Warranty

This flooring product comes with manufacturer limited warranties for the duration stated in marketing literature. The warranty applies to the original purchaser of the flooring from the date of purchase. Flooring has to be installed and maintained according to instructions. It guarantees that (1) the finish surface will not wear through, stain or fade, and (2) the floor will resist damage due to moisture from general cleaning and water spills if removed within 24 hours. Contact our Customer Service Team at 877-630-1800 to request a written copy which provides detailed terms of coverage and limitations.

Pre-Installation

OWNER/INSTALLER RESPONSIBILITY
The owner is advised to be at home during the installation for consultation/direction. The owner and installer should discuss installation and layout to maximize satisfaction. If this is not possible, consultation should be done prior to installation. Installers should be familiar with installation guidelines from National Wood Flooring Association (woodfloors.org). The owner/installer assumes all responsibility for product quality of completed installation.

PERFORM PRE-INSTALL INSPECTION. FOR CLAIMS PURPOSES, YOU ARE ALLOWED TO OPEN UP TO 4 BOXES FOR PRODUCT INSPECTION. DO NOT OPEN ALL THE BOXES. OPENING ALL THE BOXES CONSTITUTES YOUR ACCEPTANCE OF THE PRODUCT. INSPECT ALL THE PLANKS IN THESE 4 BOXES CAREFULLY. EXAMINE FLOORING FOR COLOR, FINISH AND QUALITY. IF YOU DISCOVER THAT PRODUCTS ARE DEFECTIVE, OR IF MATERIAL IS QUESTIONABLE, YOU SHOULD CONTACT THE RETAILER. IF YOU ARE SATISFIED, PROCEED WITH INSTALLATION.

Prior to installation, arrange planks from several boxes to ensure even distribution of colors, shades and characteristics in the installed flooring.

Purchase flooring to be installed in one large area at the same time. Product purchased at a later time than the first purchase may vary beyond your expectations.

Accessories, trims and moldings are manufactured to coordinate with the varied appearances of the floor planks. Any exact matches are coincidental. Non-matching accessories are not defective products.

This product is manufactured according to strict quality standards. In the event that defects are discovered in the field, the industry standards permit a defect tolerance not to exceed 5%. Order an additional 5% extra for cutting wastage and grading allowances (10% for diagonal installations).

During installation, inspect the planks continuously. Defects that can be seen from a standing position should be cut off or held out. Installing defective planks implies acceptance.

Squeaking and clicking noises are the result of interactions among flooring, joists and subfloors when they move. Limiting the movements of the flooring system usually eliminates most of these noises.

Sometimes, it is impossible to eliminate them completely and minor squeaking or clicking noises are to be accepted as normal flooring phenomenon.

Minor scratches can generally be repaired with the use of putty, stain or filler. It is an industry standard practice of flooring installation and it should be accepted as normal by the home owner.

To assure the warranty is not inadvertently voided, before proceeding with any activity that is not covered in this manual, please contact our Customer Support Team at 877-630-1800.

CONCRETE SUBFLOOR REQUIREMENTS
Concrete subfloors must:

- Have minimum rated strength of 3000psi.
- Be level to within 1/8 in. in a 6 ft. span or 3/16 in. in a 10 ft. span; no bumps or low spots. High spots can be removed by grinding; depressions can be filled with patching compound formulated for use in floor installation.
- Be clean; no construction debris, soil, mud and any other objects on or adhering to the floor; if necessary, scrape and sweep away before the installation; no protrusions of nails, debris, metals should remain.
- New concrete slab must cure for at least 60 days. It must have a minimum 10 mil polyethylene sheet between the ground and the concrete.
- Be free from moisture related conditions which can damage the installed flooring.

CONCRETE MOISTURE
Test all concrete subfloors for moisture content and document the results. Visual checks are not reliable. Perform tests at locations around exterior doorways, near walls containing plumbing, near foundation walls and in the center of the room. Minimum sample size is 3 samples per 1000 sq. ft. of area and one test for every additional 1000 sq. ft. thereafter.

Moisture content should meet one of the following criteria:

- 5% when tested using Tramex Concrete Moisture Encounter.
- Less than 3 pounds per 1000 sq. ft. per 24 hours when using Calcium Chloride test (ASTMF1869).
- 75% when using Relative Humidity Testing (ASTMF-2170).

NOTE: Concrete moisture content may be acceptable at the time of the test. These tests do not guarantee a perpetual "dry" concrete slab. The concrete slab moisture content can vary at other times of the year. We are not responsible for moisture-related damage to installed flooring.

WOOD SUBFLOOR REQUIREMENTS
The subfloor must be clean; no presence of construction debris, soil, mud and any other objects on or adhering to the floor; no protrusions of nails, debris, or metals should remain. If necessary, scrape and sweep the subfloor before the installation.

The subfloor must be structurally sound and stable; no movements or squeaks; no loose panels or loose nails; no signs of ply de-lamination or other damages. Repair all shortcomings before installation.

The subfloor must be flat; no visible bumps or low spots; the subfloor should be flat to within 1/8 in. in 6 ft. span or 3/16 in. in 10 ft.. Test for moisture using a reliable moisture meter. Perform tests at locations around exterior doorways, near foundation walls, near walls containing plumbing lines and in the center of the room. Measure 20 locations per 1000 sq. ft. Moisture content of the subfloor should be less than 12%. Moisture content difference between the subfloor and flooring should be 2% or less.

PLYWOOD OR ORIENTED STRAND BOARD (OSB) SPECIFICATIONS
On truss/joist spacing of 16 in. (406 mm) O/C or less, the industry standard for single-panel subflooring is a minimum 5/8 in. (19/32 in., 15.1 mm) CD Exposure 1 plywood subfloor panels (CD Exposure 1) or 23/32 in. OSB Exposure 1 subfloor panels, 4 ft. x 8 ft. sheets. Expansion gap between panels should be 1/8 in. (3 mm). If panels are not tongued and grooved and there is not sufficient spacing or is inadequate, cut/inherted spacing with a circular saw. Do not cut in expansion space on tongue and groove panels.

PARTICLE BOARD OR FIBER BOARD
Only for floating installation.

EXISTING FLOORS
Installation over existing floor requires the installer to consider potential issues related to moisture damage, adhesive failure and fastener failure. Contact the adhesive and fastener manufacturers respectively for their specific instructions, recommendations and requirements.

Acceptable floor coverings include: solid hardwood, linoleum, terrazzo, ceramic tile and other "moisture sealing floors."

Unacceptable floor coverings include: carpet, needle punch felt, edge glued linoleum and other "moisture absorbing flooring."

JOB SITE CONDITION
Prior to installation, the installer must ensure that at the time of installation, the job site conditions including subfloor/substrate, ambient temperature and relative humidity, and all impacting variables will not negatively affect the floor. The manufacturer will decline responsibility for damages associated with improper installation or poor site conditions.

STORAGE AND CONDITIONS
Do not store flooring in uncontrolled environmental conditions. For example, garages and exterior patios are not acceptable areas to store flooring. Handle and unload flooring with care and store within the environmentally controlled site in which it is expected to perform. Flooring stored on a concrete slab should be elevated at least 4 in. to allow air circulation under cartons.

EXISTING HOME
An existing home should have a consistent room temperature of [60°F-80°F and relative humidity (RH) of 35%-55%]. Continual deviation from these conditions will affect the dimensions of flooring. When using a heater during winter months, humidity may be much lower than the acceptable range. A humidifier is recommended to prevent excess shrinkage in flooring due to low humidity levels. During the warmer months, maintain humidity levels using an air conditioner, dehumidifier, or by turning on your heating system periodically.

NEW CONSTRUCTION OR REMODEL
All work involving water, such as pouring basement concrete floors, drywall and plasterwork, plumbing, etc. must be completed well in advance of the floor delivery. Ensure that the building is enclosed. Where building codes allow, permanent heating and/or air conditioning systems should be operating at least five days preceding installation and should be maintained during and after installation. If it is not possible for the permanent heating and/or air conditioning system to be operating before, during and after installation, a temporary heating and/or dehumidification system that simulates normal living (occupied) conditions can enable the installation to proceed until the permanent heating and/or air conditioning system is fully operational. Your job site should have a consistent temperature of [60°F-80°F and relative humidity (RH) of 35%-55%] which should be maintained continuously thereafter.

BASEMENTS AND CRAWL SPACES
Concrete slab or ground must be dry. Ensure that crawl spaces have open vents year-round for proper air circulation and prevent moisture build up. The ground in the crawl spaces must be completely covered using 6 mil black polyethylene. Crawl space clearance between the earth and underside of joists should be no less than 18 in. and the perimeter of the vent area should be equal to 1.5% of the total square footage of the crawl space or as mandated by code.

RADIANT HEATED SUBFLOOR
This product can be installed over radiant heated subfloor. The radiant heat system should be operational for at least 7 days before beginning installation. Turn off heat to allow the subfloor to cool down to room temperature 3-4 hours before beginning the installation. Increase temperature gradually after installation. Operating surface temperature must not exceed 85°F (29°C). Contact heater manufacturer for specific installation instruction. Consult with the radiant heat system manufacturer to ensure that the system is compatible.

MOISTURE BARRIER AND UNDERLAYMENT PADDING
CONCRETE SUBFLOOR
When installing over concrete slab, it will be necessary to use a moisture barrier to prevent moisture migration. A plastic film with a minimum thickness of 6 mil should be placed with a 4-6 in. (10.2-15.2 cm) overlapped seam, and taped with a suitable tape, this should be combined with an approved underlayment padding for floating floors.

SOUND CONTROL UNDERLAYMENT
It is optional. Check with sound control manufacturer for application guidelines. Generally, the less compressive underlayment is preferred.

EXPANSION GAP
Required gap width range is 5/16 in. to 3/8 in. It is required around the perimeter of the floor and between floor and all vertical obstructions. Do not place permanently mounted structures such as kitchen counter/cabinet on the installed floor.

TRANSITION MOLDING
Floating installation, transition T-molding is required in the following cases: floor spanning greater than 40 feet in length or width; doorways or passageways 5 ft. wide or less. Note: Floor areas interrupted by wall openings greater than 5 ft. wide, or interrupted by wall sections extending out of the wall, or floor areas which are not rectangular may experience buckling or gapping if there is excessive floor expansion or shrinkage.

TOOLS AND MATERIALS BASICS

- Tape measure
- Moisture meter (wood, concrete or both)
- Chalk line & chalk
- Hammer
- Electric power saw
- Carbide tipped saw blade for fine cut
- NIOSH-designated dust mask
- Handsaw or jigsaw
- Eye protection
- Straight edge or Spacers
- Pry Bar
- Mallet
- Broom
- Color matched wood putty
- Tapping block
- Pull bar
- Painters tape
- Laminate underlayment

Helpful Pointers

GENERAL TIPS

- Make sure your work area is well lit. Good visibility ensures that color is consistent and that visually defective planks are detected and removed.
- The remainder of the last plank can be used as a starter board on the following rows. The minimum length of the first and last plank needs to be longer than the width of the material being installed.
- Using a shorter piece at under cut door jams will help when fitting flooring in place.
- Never hit the flooring directly with the tapping block and be careful not to fracture floor edges.

CUTTING THE LAST ROW TO WIDTH

- Most often the entire length of the last row will need to be cut so that it is narrow enough to fit the remaining space.
- Measure the distance between the floor face edge (exclude the tongue) to the wall. Subtract [5/16 - 3/8 in.] from this measurement for expansion gap. Draw a line. Cut through the line. Discard the excess piece. Proceed with the installation.

Preparing for Installation

□ Acclimate for 48 hours in unopened box. Installation temperature range is 60°F - 80°F with a relative humidity (RH) of 35%-55%. Conditions in which the floor was installed should be maintained continuously thereafter.

□ Ensure subfloors are clean.
Lay out several cartons. Randomly arrange planks to ensure good color and shade mixture and end joint spacing. Inspect plank quality and grading. Lay out trim moldings in advance and find planks whose shade closely matches. Set these aside for future use.

□ Remove the existing base, shoe molding or threshold carefully. They can be used to cover the 5/16 - 3/8 in. expansion gap left around the edge of the room.

□ Undercut doors and casings using a handsaw laid flat on a piece of scrap flooring.

□ Install the underlayment (if used) parallel to the flooring according to the underlayment manufacture instruction. Any overlap (top) should be on the same side as the groove of the flooring so that the floor planks will slide smoothly into place. Tape all seams. Secure the underlayment material as necessary to prevent excessive movement.

Installation

1. INSTALLING THE FIRST ROW
When starting the first row; remove the tongue from the width and length of the first plank. This is the starter plank that will guide the expansion gap between the plank and the wall around the perimeter of the area. Be sure to allow enough space for the 5/16-3/8 in. expansion. Use spacers between floor plank and wall. Saw off the tongue from only the length of the remaining planks to be installed in the first row.

2. INSTALLING THE SECOND AND REMAINING ROWS
Install planks by angling long edge 35°-45° into the joint of the previous plank. Make sure the tongue is tightly engaged in the groove by applying balanced pressure in the direction of the groove. Use spacers or scrap pieces of flooring along the wall to maintain the expansion gap. Make sure there is a random stagger at the end joints of at least 6 in. apart.

3. USING A TAPPING BLOCK
A tapping block is recommended to ensure there's no gapping in the installation process between rows and between short end joints. A tapping block protects the face and locking edges from the hammer and allows you to secure the tongue into the groove of the adjacent plank.

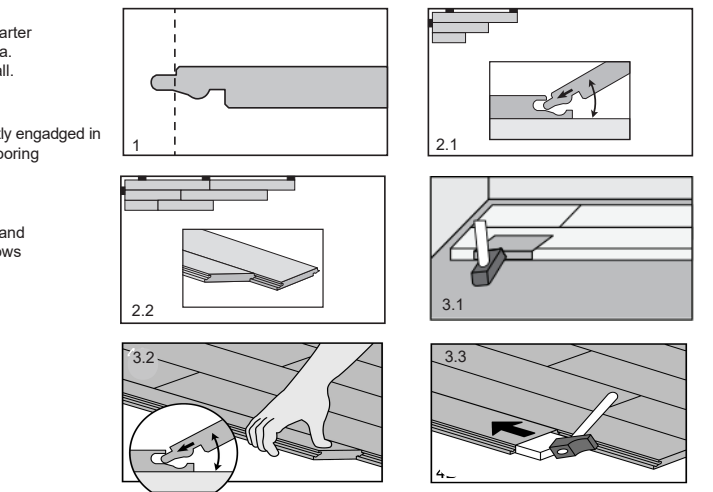
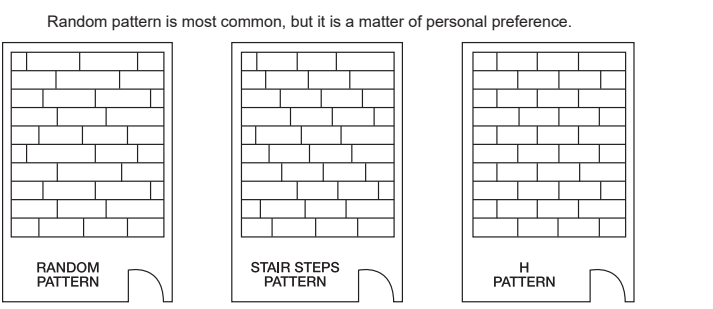

4. EXPANSION GAP AND SPACERS

Continue with the installation process. Ensure the expansion gap is maintained around the entire perimeter by using spacers.

5. INSTALLING THE LAST ROW

Use a pull bar to draw the last row to fit tightly to the previous row.

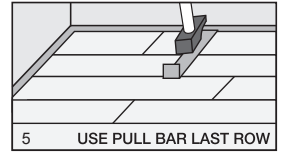
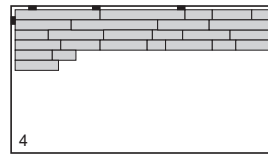

Sealing the perimeter: Once the installation is complete, use 100% silicone sealant around the perimeter of installed flooring. First, fill the expansion gap with PE foam backer rod, then cover is with 100% silicone sealant.

Finishing Touches

- Clean the floor.
- Use matching putty where necessary.
- Install or reinstall all wall trim pieces. Nail them through the wall, but not to the subfloor to avoid restricting the expansion gap.
- Install transition trim pieces. Nail them to the subfloor, not the flooring.
- At doorways, transitions should be used to protect the edges of the floor and to provide a decorative transition from one floor type to another. If the floor is to be covered, use a breathable material such as cardboard. Do not cover with plastic.

Accessories

Pictures are for general illustrative purposes only. Actual products may differ from diagrams.

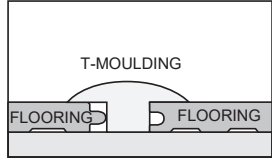

T-Molding: Used to create a transition between floor coverings of similar heights or to cover an expansion gap

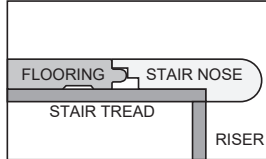

Stair Nose: Used in conjunction with flooring installed on stair steps or finished edges of a higher level floor like in a sunken living room.

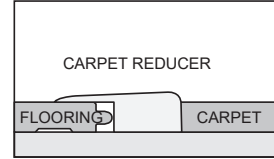

Carpet Reducer (also called Baby Threshold or End Cap): Used to transition floor coverings of differing heights. This reducer strip is also commonly used to border a fireplace, sliding glass door and other exterior door jambs.

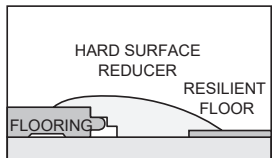

Hard Surface Reducer: Used to transition to another hard surface flooring of different heights such as tile, vinyl, or concrete.

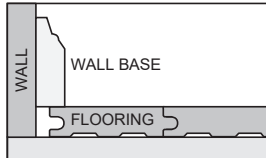

Wall Base: Used to give a finished look at the base of the walls. It can be used with or without quarter round.

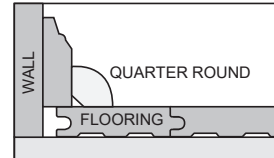

Quarter Round: Used to cover the expansion space between the wall base and your flooring. It can also be used to make smooth transitions between the floor and cabinetry. It can be used with or without wall base molding.

Care and Maintenance

DAILY MAINTENANCE

- Sweep, dust, mop, or vacuum your floor regularly to remove any particles that could cause abrasion or scratch your floor.

CAUTION: Vacuums with a beater bar or power rotary brush head can damage a floor and should never be used.

Your floor is water resistant from standing surface water up to 24 hours. However, it is a good prevention to follow the care instructions below, to ensure you do not leave water longer than it is designed to be.

- Use a damp mop to remove spots and soil. Apply appropriate cleaning solution to the cleaning cloth / mop. Do NOT apply directly to the floor.
- For lightly soiled areas, clean with distilled water.
- For moderately soiled areas, use a mild solution of isopropyl (rubbing) alcohol and distilled water. Dilute the mixture by mixing one part alcohol and 2 parts distilled water. For tougher spots, use a higher concentration of isopropyl alcohol and distilled water. For extreme cases, a solution of nail polish remover and distilled water can be used.
- HINT: For best results, clean the floor in the same direction of the planks. When the cleaning cloth/mop becomes soiled, rinse or replace it with a clean one. Following up with a clean, dry cloth will remove residual streak marks and spots.
- DO NOT** leave any amount of liquids (water, juice, soft drinks, spills, etc.) on the floor. Clean any wet spots immediately.
- DO NOT** use a steam cleaner.
- DO NOT** use a wet mop or douse the floor with water or liquid cleaners. Liquid can seep between the cracks and cause moisture damage.
- DO NOT** use any cleaning agents containing wax, oil or polish. Left over residue will form a dull film.
- DO NOT** use steel wool or scouring powder which will scratch the floor.

BRANDED OR OFF-THE-SHELF FLOOR CARE PRODUCTS

If none of the above are effective and you choose to use a store bought product, test the product in a non-conspicuous area (i.e., closet, corner, or scrap pieces) for potential adverse side effects.

PREVENTATIVE MAINTENANCE

- Protect your floor when using a dolly for moving furniture or appliances. Protective sheets and/or plywood may be needed. Never slide or roll heavy furniture or appliances across the floor.
- Place protective pads beneath furniture legs and other heavy objects.
- Avoid excessive exposure to water from being tracked in during periods of inclement weather.
- Minimize abrasive material and dirt by placing mats on both sides of exterior doors and by using area rugs in high-traffic areas.
- Rearrange furniture and rugs periodically to avoid uneven color and shade changes from light exposure.
- Use protective mats beneath rolling chairs and keep furniture casters clean.
- Keep pets' nails trimmed.
- Remove shoes with cleats, spikes or exceptionally pointy heels before walking on the floor.

CLIMATE MAINTENANCE

- Care should be taken to control humidity levels within the 35%-60% range. Flooring, especially hardwood and bamboo, dimensions will be affected by varying levels of humidity.
- Dry Climates: A humidifier is recommended to maintain humidity levels. Wood stoves and electric heat tend to create very dry conditions during the winter months. This also will cause shrinkage in flooring.
- Humid, Wet Climates: By using an air conditioner, heater, or dehumidifier, proper humidity levels can be maintained to prevent excessive expansion due to high moisture content.

FLOOR REPAIR

- Very light and small surface scratches can be repaired with a staining "touch up" pen of the appropriate color.
- Slightly deeper scratches can be repaired by means of colored putty or stains. Fill the scratches with the putty. Level with putty knife. Wipe off excess putty.
- Very deep scratches may require the replacement of the planks.