

HANOVER®

Hanover Outdoor Furniture



IMPORTANT

If you have any problems with this product (missing or damaged parts, assembly issues, etc.),

PLEASE DO NOT RETURN TO THE RETAILER/STORE

from where you purchased the product.

Please call our Toll-Free Customer Service Hotline at: **1-866-851-8438**







Between 9:00 AM and 5:00 PM Eastern Time, Monday through Friday

Or visit our website at: **www.hanover-products.com**

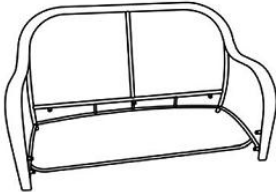
To expedite any future warranty claims, please retain the Instruction Sheet, Warranty Card and receipt for future use.

For additional on-line support on assembly, troubleshooting and care & maintenance of your outdoor furniture, please visit our website at: **www.hanover-products.com**.

PARTS LIST

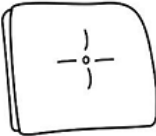
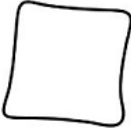
PART#	DESCRIPTION	PICTURE	Q'TY
A	Chair Frame		1
B	Seat		1
C	Bolt M6x15		7
D	Washer M6		7
E	M6 Bolt Cover		7
F	Open Wrench		1
G	Seat Cushion		2
H	Back Cushion		2
I	Toss Pillow		2

Assembly Steps:

Step 1:

Part# A x 1

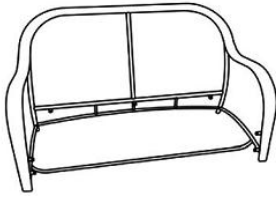

Part# B x 1



Part# C x 7

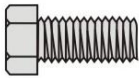

Part# D x 7



Part# E x 7

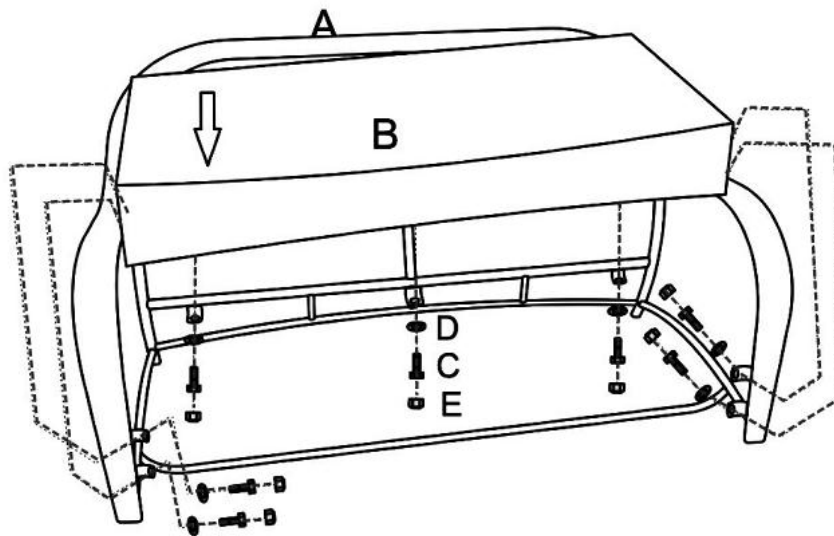

Step 2:

Part# G x 2





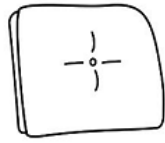



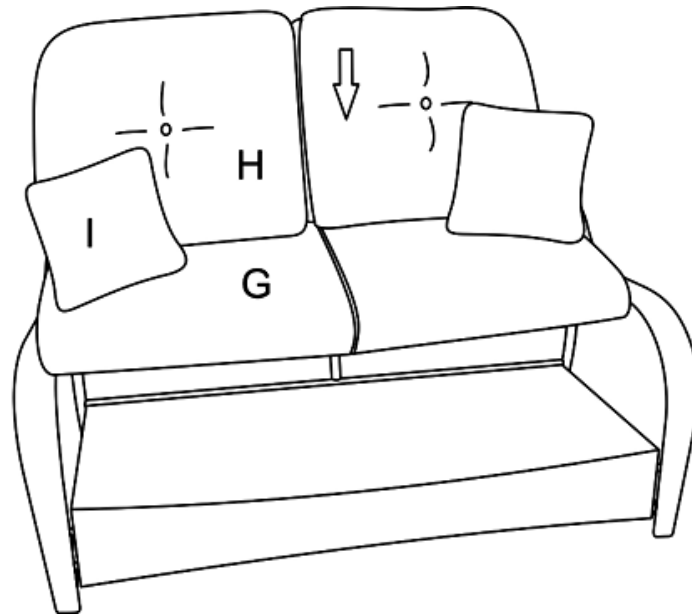
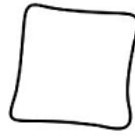

Part# H x 2

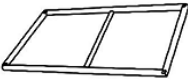

Part# I x 2

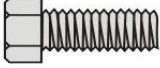

PARTS LIST

PART#	DESCRIPTION	PICTURE	Q'TY
A	Table Rim		1
B	Table Leg		4
C	Connecting plate		1
D	Glass Top		1
E	Bolt M6x15		12
F	Washer M6		12
G	Bolt Cover M6		12
H	Open Wrench		1

Assembly Steps:

Step 1:

Part# A x 1

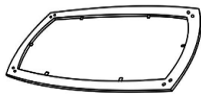

Part# B x 4



Part# E x 8

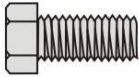

Part# F x 8



Part# G x 8

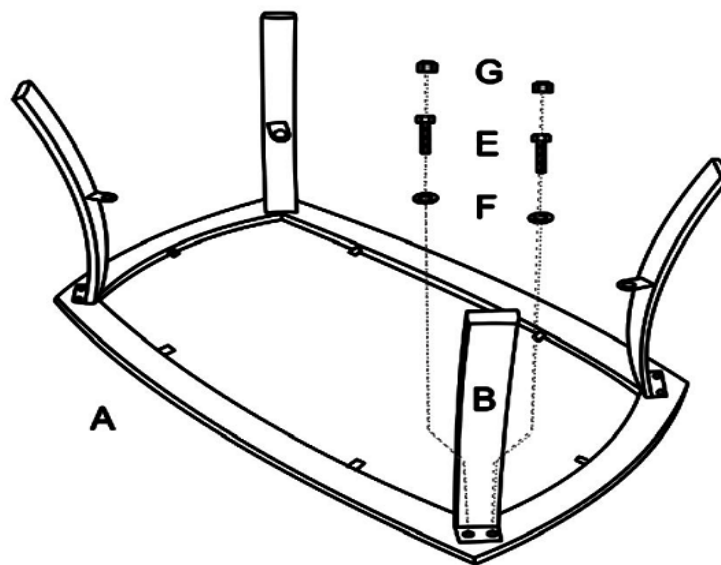

NOTE: DO NOT tighten the bolts completely at this stage.

Step 2:

Part# E x 4

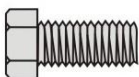

Part# F x 4



Part# G x 4



Part# C x 1



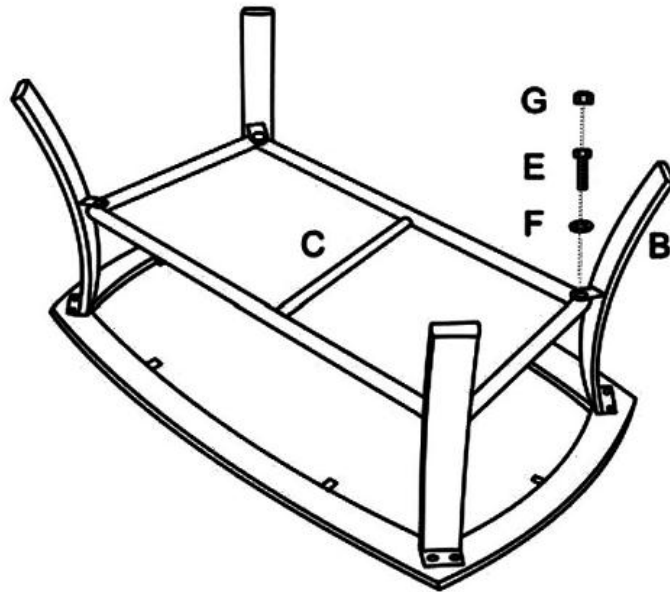

NOTE: DO NOT tighten the bolts completely at this stage.

Step 3:



Part# D x 1

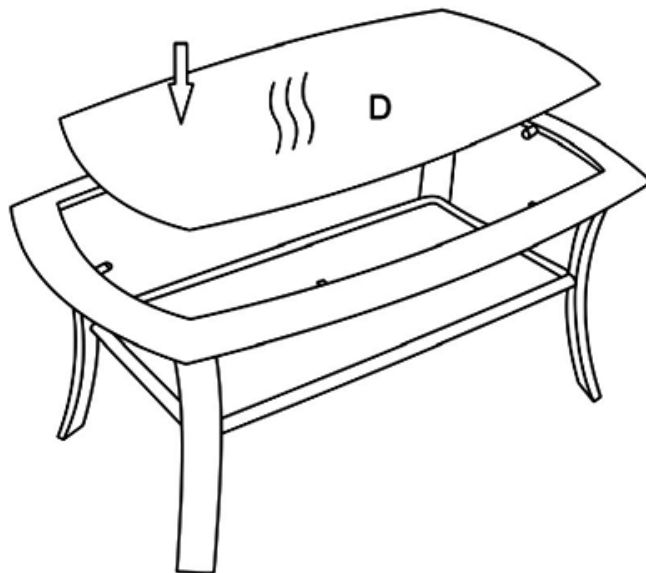

NOTE: Tighten completely until all bolts are in place.

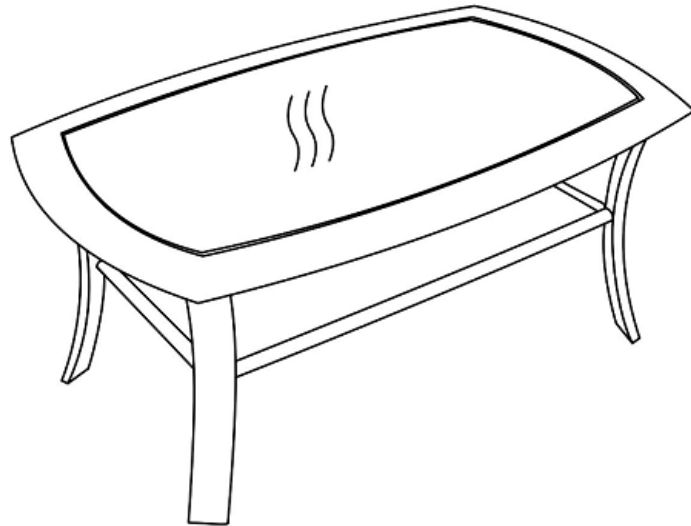

WARNING:

1. Do not crawl, stand or sit on the glass table tops.
2. Do not set or lay heavy items on glass table tops.
3. Avoid extreme hot and cold items being placed on glass table tops.
4. This glass table top is produced with tempered glass which is designed to safely shatter into small pieces when impacted or stressed beyond its strength limitations.