

BRUSH BEAST

36" BRUSH MOWER by **DEK**

Owner's Manual

This manual contains important safety instructions for the gasoline engine powered brush mower models: 36BB, 36BDB

READ SAFETY WARNINGS AND OPERATING INSTRUCTIONS CAREFULLY.
SAVE THIS MANUAL.



Need Help?

Parts, Service
and Technical Assistance call:

1-919-550-3221

www.brushbeast.com

When you call the help-line you will need to have the following information:

Date of Purchase: _____
Location of Purchase: _____
Serial # - Mower: _____
Serial # - Engine: _____
Serial # - Hydro Trans (L) _____
Serial # - Hydro Trans (R) _____

Mower and engine life are extended greatly by performing frequent lubrications, oil changes and regular maintenance. To protect your investment perform routine maintenance.

Copyright© 2010 by GXi Outdoor Power, LLC. All rights reserved.

No part of this publication can be reproduced or distributed without prior written permission of GXi Outdoor Power, LLC Clayton, NC 27520 USA.

DEK is a registered trademark of GXi Outdoor Power, LLC

GXi Outdoor Power, LLC reserves the right to discontinue or change specifications or design at any time without notice and without incurring any obligation whatsoever.

The information and specifications included in this publication were in effect at the time of approval for printing.



This manual contains important safety instructions for Brush Mowers
READ SAFETY WARNINGS AND OPERATING INSTRUCTIONS CAREFULLY
SAVE THESE INSTRUCTIONS.

This owner's manual is considered a permanent part of the brush mower and should remain with the brush mower if resold.

BEAST SERIES

Check out our other great products at www.HomeDepot.com
or visit our web site at www.brushbeast.com



Contents

Safety Information and Warnings.....	1
Operation Safety Precautions	2
Safety Decals	3
Product Specifications	4
Control Panel and Brush Mower Components	5
Assembly Instructions	
Step 1: Front Wheel Assembly	6
Step 2: Mower Assembly	7
Step 3: Wire Harness Assembly and Connections	8
Step 4: Throttle and Choke Cable Connections	8
Step 5: Fuel Tank Connections.....	9
Step 6: Brake Set-up.....	9
Operating Instructions	
Starting the Engine.....	10
Operating the Mower	10
Disengaging Hydrostatic Drive Units	11
Return to Neutral.....	11
Cutting Brush	12
Removing the Blades.....	13
General Maintenance.....	14
Maintenance Schedule	15
Service Adjustments.....	16
Lubrication Points.....	18
Deck Interchange.....	18
Troubleshooting.....	19
Limited Warranty and Service.....	21

About the BRUSH BEAST Mower Manual

Congratulations on the purchase of your new BRUSH BEAST commercial mower. We at GXi Outdoor Power are confident that this mower will provide excellent performance, outstanding quality, and great durability when operated and maintained as directed in this manual.

1. This manual contains assembly, operating, safety, adjustment, maintenance, and troubleshooting instructions. **BEFORE OPERATING YOUR BRUSH MOWER, CAREFULLY READ THIS MANUAL IN ITS ENTIRETY.**
2. This owner's manual is considered a permanent part of the mower. It must be available to all operators and/or person(s) servicing the mower. Should the mower be resold, this manual must remain with the mower.
3. All information, illustrations, and specifications contained in this manual were in effect at the time of the publication. GXi Outdoor Power reserves the right to add, delete or modify specifications and/or designs without notice.
4. If you ever have questions in regards to the operation, maintenance or safety of your mower, please contact GXi Parts & Service, LLC at 1-919-550-3221.

Safety Information

BRUSH BEAST brush mowers are designed to give safe and dependable service if operated according to instructions. Read and understand this owner's manual before operating your brush mower.

Emission Control System InformationThe U.S. and California Clean Air Acts

EPA and California regulations require all manufacturers to furnish written instructions describing the operation and maintenance of emission control systems. The following instructions and procedures must be followed in order to keep the emissions from your engine within the emission standards.

Safety Label Locations

Safety labels are located on your mower to warn you of potential hazards. Read them carefully. If a label comes off or becomes hard to read, contact GXi Parts & Service, LLC for a replacement.

Operator Responsibility

Be sure that anyone who operates the brush mower receives proper instruction. The operator must know how to stop the brush mower quickly in case of emergency, and understand the use of all controls, output receptacles and connections. Children should not operate the brush mower without parental supervision.

Mower Inspection

For your safety, inspect the mower before each use. Before you begin your inspection, be sure the following conditions are met: the brush mower should be on a flat and level surface, with the ignition switch off, the key removed, and the blades disengaged. Also, disconnect the spark plug wires from the spark plugs and ground them against the engine to prevent inadvertent starting.

1. Walk around the mower and look for any fluid spills or leaks on or underneath the mower. Remove any and all excessive debris, dirt, and fluids.
2. Look for signs of damage or excessive wear. Check the tightness of all nuts, bolts, pins and screws. Tighten any that may be loose and replace any that are missing.
3. Be sure the safety interlock controls are operating properly so that the engine cannot be started unless the ground speed control lever is in neutral and the blades are disengaged.
4. Check the mower blades for any damage or abnormal wear. Replace in sets so that they are balanced.
5. Check for blade freedom. Each blade should pivot 360° around the pivot bolts. If blades are stuck, the blades should be freed before operating the brush mower.
6. Inspect all rubber guarding for excessive wear. Before operating the mower, replace any guarding that is damaged or missing.
7. Check the tire pressure on both tires. Do not exceed the recommended 24 PSI maximum.
8. Check the belts for proper wear and correct tension. See pages 16 for instructions.
9. Check engine oil and air filters as recommended in the engine manufacturer's manual.

**WARNING**

WARNING! Do not use your BRUSH BEAST mower to carry passengers. Keep bystanders, helpers, children and pets at a safe distance from the machine while it is in operation since rotating blades can throw rocks and other items, causing serious injury. Check the area before you begin mowing for stones, sticks, wire, and other foreign objects. These objects may become projectiles when struck by the mower.

**WARNING**

WARNING! Wear protective clothing while mowing. Long pants and safety glasses help reduce the risk of injury from thrown objects. Adequate footwear, such as steel toe shoes with aggressive soles, is recommended to help protect your feet and maintain traction on slopes or uneven grounds. Always wear hearing protection.

**WARNING**

DANGER: GASOLINE IS HIGHLY FLAMMABLE AND EXPLOSIVE. Do not add fuel while the engine is running or is hot. Keep open flames, sparks, and heat away from the fuel and store fuel in containers specifically designed for that purpose. **ADD FUEL OUTDOORS ONLY AND IF THE FUEL IS SPILLED, DO NOT START THE ENGINE.** Manually push the mower away from the spill and wipe up immediately.

Equipment Operation—Safety Precautions

1. Do not operate the engine in a confined space where dangerous carbon monoxide fumes can collect. Carbon monoxide is odorless, tasteless, and can be fatal.
2. Mow only in daylight.
3. Make sure the mower is in neutral and the blades are disengaged before attempting to start the engine.
4. Be extremely careful when operating the mower on a slope or when the grass is damp or wet. Reduced traction could cause sliding.
5. Do not stop or start suddenly when going uphill. Use extreme caution when changing directions while operating on a slope.
6. Avoid steep slopes. Never use riding attachments on slopes since there is an increased risk of roll over.
7. Never mow by pulling the mower back towards you because you might slip.
8. Watch for pedestrian or vehicular traffic when moving the mower while not in use (i.e., loading, unloading or transporting).
9. Never operate the mower with defective guards or shields, or without the safety devices securely mounted in place.
10. Never direct discharge of material toward bystanders nor allow anyone near the mower during operation.
11. Do not change the governor settings or over speed the engine.
12. Always stop the engine when you leave the mower, even for a moment.
13. To help reduce the fire hazard, keep the engine and the area around the engine free of grass, leaves or any other type of foreign material.
14. Beware of cutting edges. Always wear gloves for safety when performing blade maintenance activities. Beware on multiple blade units since the rotation of one blade may cause the rotation of the other blade.
15. Do not operate the mower with the grass chute deflector in the raised position. Serious injury could occur.

GASOLINE IS HIGHLY FLAMMABLE AND EXPLOSIVE. FUEL LEAKS, A LOOSE FUEL TANK, OR A LOOSE FUEL VALVE CAN LEAD TO SEVERE INJURY OR DEATH. DO NOT OPERATE THIS BRUSH MOWER IF ANY COMPONENT OF THE FUEL SYSTEM IS LOOSE OR LEAKS GASOLINE!

IMPORTANT! The brush mower blades do NOT stop quickly. Visual indication that the blades are turning is provided at the center of the belt guard. DO NOT approach the brush mower deck for service, cleaning, removing debris, or for any other reason until after the visual warning disk has stopped completely. Even at slow speeds the blades can cause serious injury or death.

Before setting up your brush mower, disconnect the spark plug wires from the spark plugs and ground them against the engine to prevent inadvertent starting. This step should be taken as a precaution whenever you are working on this machine.

DANGER: Do not bypass, modify, alter or disconnect the safety system. Make sure that the safety interlock system is fully operational each time before mowing.

Before attempting to use your mower, make sure you are familiar with all of the components and have read the manual.

Need Help?

Parts, Service
and Technical Assistance call:

1-919-550-3221

www.brushbeast.com

Safety Decal Identification

The labels shown below are located on your mower to warn you of potential hazards and provide you with important safety information. If these decals become difficult to read or are missing from the mower, please contact GXi Parts & Service, LLC at 1-919-550-3221 or www.brushbeast.com for a replacement.

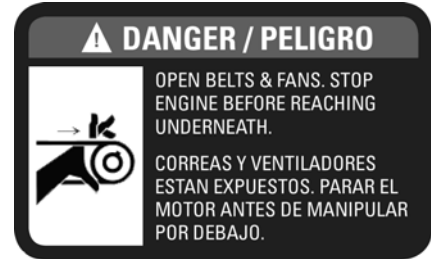
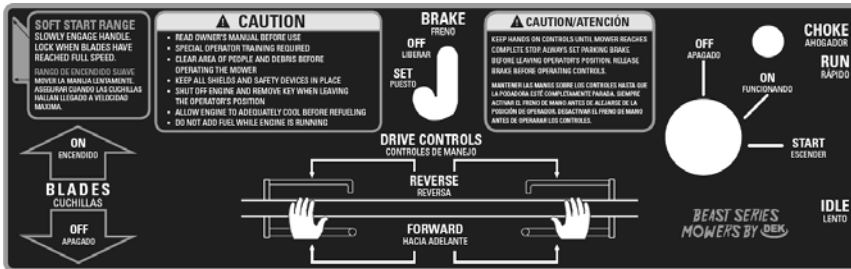
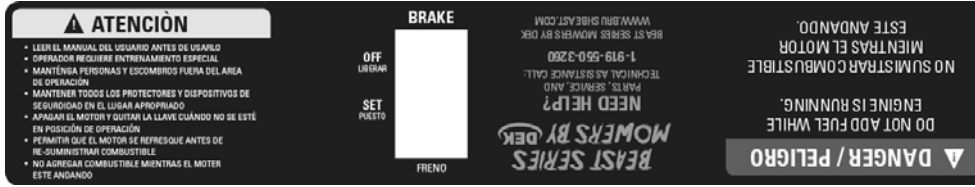

	Model
Feature	36BB and 36BDB
Product Type	Commercial, 0-turn
Cutting Width	36-inch
Engine	See engine manufacturer's manual
Engine Start	Electric
Transmission Type	Dual hydrostatic
Transmission Mfg	Peerless
Mower Speeds	Infinitely variable
Cutting Height	4 inches
Blade Engagement	Manual clutch
Blade Tip Speed	18,750 ft/min
Blades	Dual break away
Control System	V-bar E-Z hydro speed control
Fuel/Capacity	Gasoline/4.5 gallons.
Rear Drive Tires	16 x 6
Front Skid Wheels	2
Brake System	Internal hydraulic and mechanical park
Weight	Approximately 650 pounds
Height/Length	48 inches x 78 inches



Throughout this manual, instructions are given on the operation of your BRUSH BEAST mower. We recommend that while going through this manual, you have your mower available for quick and easy access in order to orient yourself with the controls, maintenance and orientation of different parts. Please read through the manual before operating.

Control Panel

Below, you will find a diagram of the control panel. Please take the time to familiarize yourself with the mower controls.

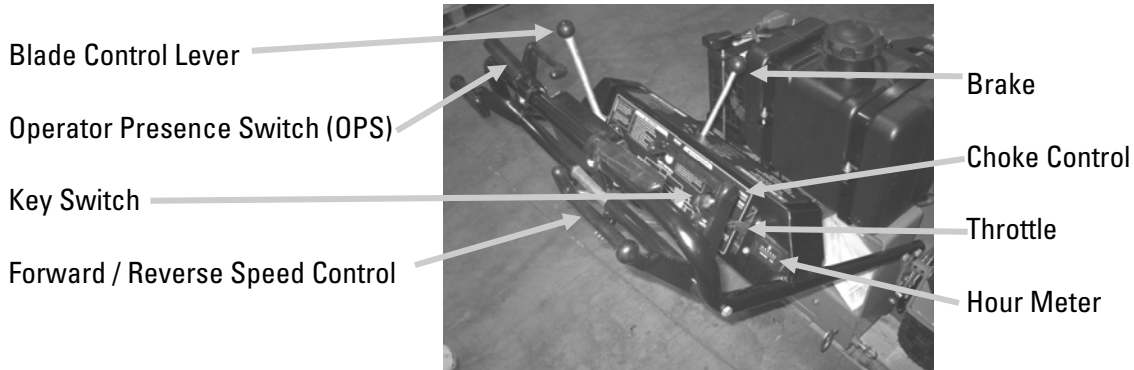

Brush Mower Components Identification

(Some components may appear different than shown, depending on the model.)

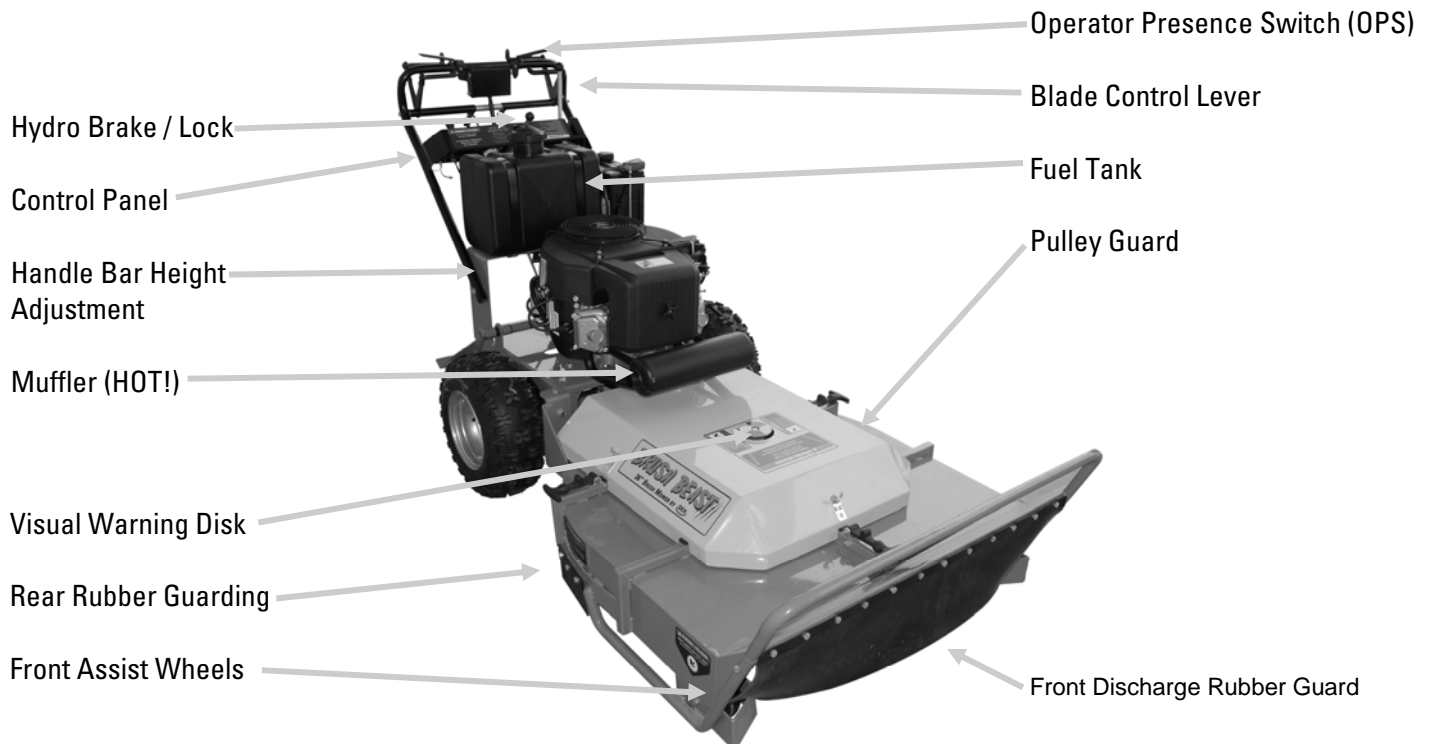

Before attempting to use your mower, make sure you are familiar with all of the components and have read the manual.

Step 1: Front Assist Wheel Assembly

The mower is shipped in a steel shipping rack (see adjacent photo). **Note:** Some mowers are shipped with the front wheels pre-assembled.

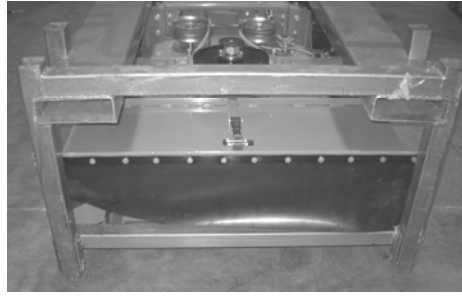

- A. Remove the rack by removing the front mounting bolt.
- B. Remove packaging materials surrounding the front skid wheel and remove the bolt. Retain the bolt, spacer, nut and bushing for future use.
- C. Remove the fastener holding the bolt to the steel shipping rack. Retain the nut and bolt for future use in the mower assembly process.
- D. Remove the mower from the steel shipping rack.
- E. Slide the front skid wheel into the mount. Position the wheel with the spacer toward the center of the mower and the wheel as close to the deck edge as possible.
- F. Secure the wheel in place with the bolt and hardware that is provided with the wheel.
- G. Follow the same procedure for the second front skid wheel.

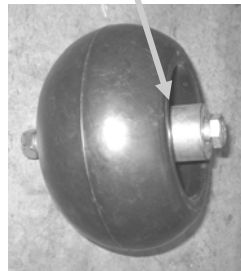
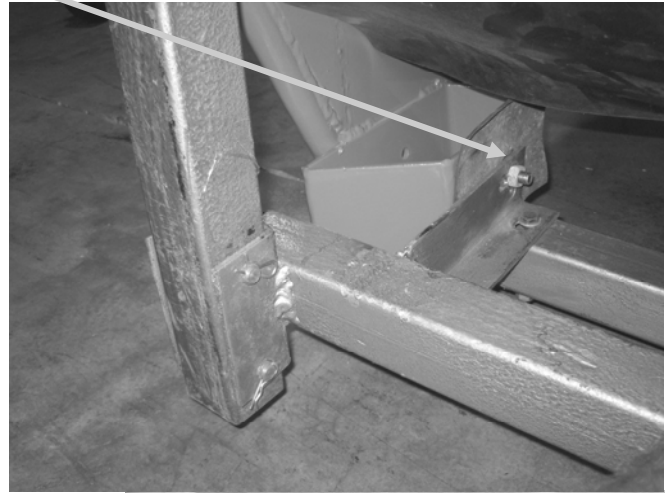

Step 2: Mower Assembly Instructions

A. Attach handle bars using the upper hole position setting. Using this hole position sets the handle bars several inches lower. Use the lower hole position raising the handle bar location by several inches for comfort, if necessary. These hole positions can also be used for adjusting the handle bar location for operators of different heights and arm lengths. Select the height that is most comfortable for you.

B. Reconnect the four (4) connecting rods from the control panel to the chassis pivot points as shown in the picture to the right. The rod connections are secured with an initial preset for the upper hole position (lower handle bar position). If the lower hole position (upper handle bar position) is used, the rod connections must be adjusted.

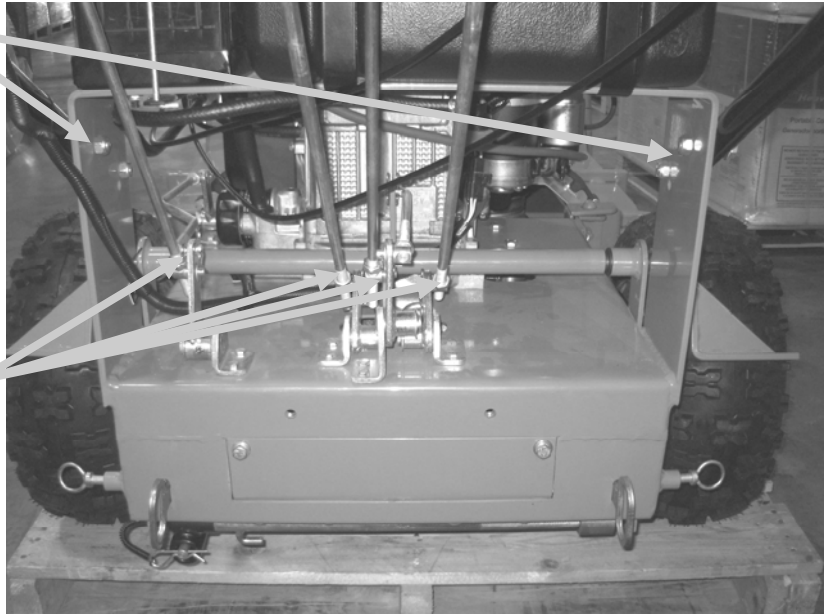

C. Should the pivot ends on the connecting rods be rotated during assembly, minor adjustments may be required to achieve full travel on each control handle. **The control handles located directly on top of the handle bars should have full travel forward and stop approximately 1/8-inch before the V-plate strikes the handle bar.** This positioning provides full forward speed and the correct restricted speed in reverse. Make minor adjustments to the position of the threaded connecting rod attachment to achieve this control positioning.

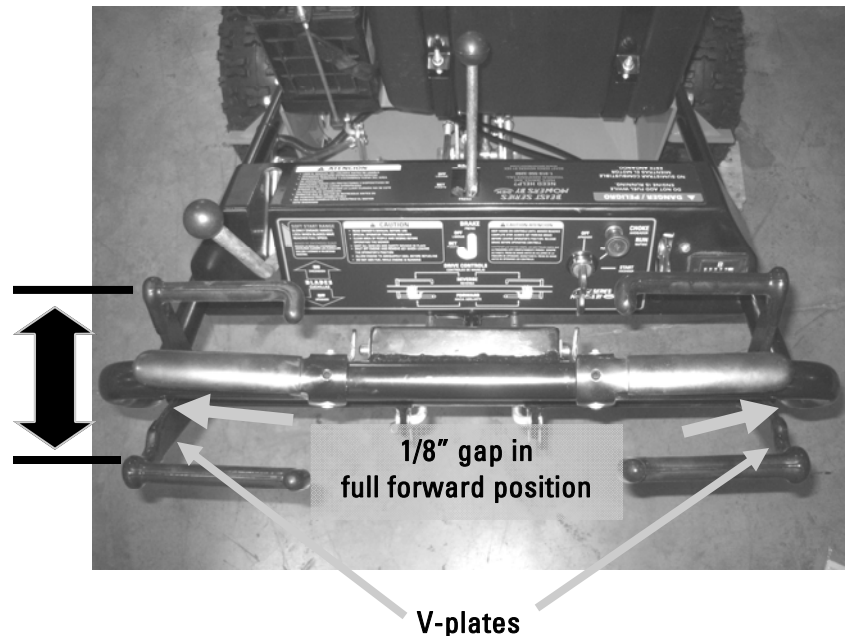

Step 3: Wire Harness Assembly and Connections

The pre-wired handle bar assembly has a total of four (4) connections. Route the wire harness as shown in the top right photo and make the following connections identified by number in the other photos:

1. Route the smaller, white, 2-pin connector through a hole in the chassis and connect it to the blade activation safety switch 2-pin connector.
2. Connect the larger, 5-pin connector to the mating connector at the rear of the engine.
3. Connect the black wire to a ground lug located on the back or side of the engine.
4. If equipped, attach the yellow wire to the bottom of the starter motor solenoid on the engine, with the positive (red) battery cable.



Attach the positive (red) and ground (black) battery terminal wires to the battery to provide power to the electric starter.

Note: Battery ground should be to the engine block.

Once all connections are made, use the provided black wire-ties to strap the wire harness into place permanently to the handle bars and chassis.

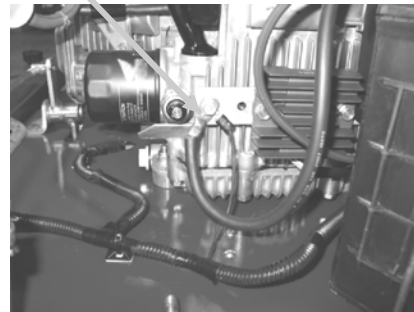
**Step 4: Throttle and Choke Cable Connections**

The throttle and choke are shown in the adjacent photo. See instructions for connecting them to the engine in the Engine Owner's Manual provided.

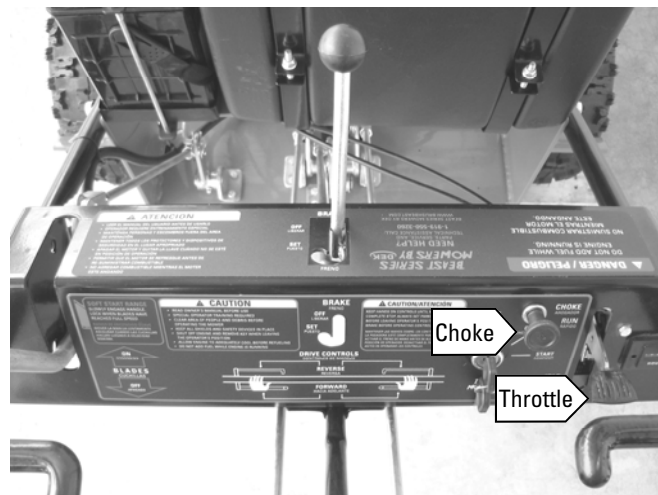

Step 5: Fuel Tank Connections

Locate the fuel tank on the fuel tank bracket with the recessed area pointing toward the rear so any spills drain away from the engine. Align the fuel valve in the center of the clearance hole. Place the fuel tank straps into position, wrapping them around the tank and the bracket.

Once the fuel tank and straps are in place, securely tighten the straps using the bolts provided. Next, firmly attach the fuel line to the fuel valve nipple. Tighten all connections to ensure they are firm and secure so the fuel system is tightly attached.

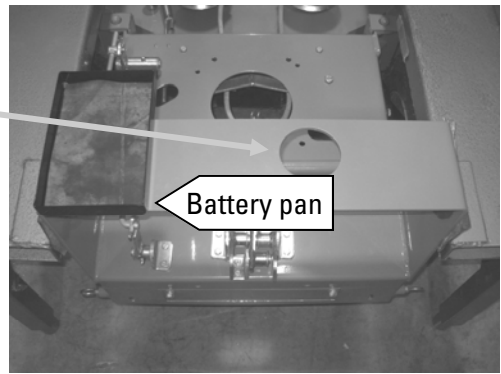

GASOLINE IS HIGHLY FLAMMABLE AND EXPLOSIVE. FUEL LEAKS, A LOOSE FUEL TANK, OR A LOOSE FUEL VALVE CAN LEAD TO SEVERE INJURY OR DEATH. ENSURE ALL CONNECTIONS ARE SECURE AND INSPECT THOROUGHLY FOR ANY POTENTIAL LEAKS IN THE FUEL SYSTEM. IF YOU FIND A LOOSE CONNECTION OR A LEAK, MAKE AN IMMEDIATE REPAIR OR ASK FOR ASSISTANCE FROM A PROFESSIONAL MECHANIC OR SERVICE CENTER.

DO NOT OPERATE THIS BRUSH MOWER IF ANY COMPONENT OF THE FUEL SYSTEM IS LOOSE OR LEAKS GASOLINE!

Step 6: Brake Set-up

1. Set the brake bar 3/4-1 inch from the tire.



Note: Verify tire pressure. Do not exceed the recommended 24 PSI maximum.

2. With the brake pivot leaning slightly forward, install the washer and pin.



3. Slide the brake handle to the bottom of the slot then connect the brake pivot to the brake handle.

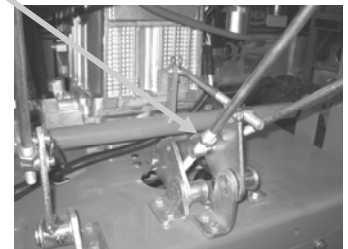

4. Slide the brake handle to the Set position to clamp the brake bar against the tire.



Note: If more or less brake force is necessary or desired, repeat the procedure, changing the gap in Step 1.

Starting the Engine



DANGER: Exhaust contains poisonous carbon monoxide, a colorless and odorless gas. Breathing exhaust can cause loss of consciousness and may lead to death. Do not operate the engine in a confined space where dangerous carbon monoxide fumes can collect.

NOTE: Be sure to add fresh unleaded gasoline and fill the engine with manufacturers recommended motor oil before starting your mower.

1. Make sure the shut off valve, located at the bottom of the tank, is in the ON position.

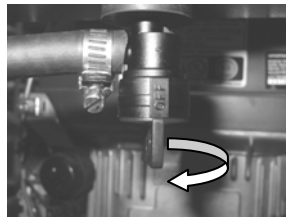

2. Make sure the brake is set.



3. Make sure the blade control lever is in the OFF position.
4. Pull CHOKE if necessary.
5. Turn the key clockwise to the START position and allow it to return to the ON position when the engine starts.
6. When the engine starts to run and the key returns to the ON position, push CHOKE off.

Before attempting to use your mower, make sure you are familiar with all of the components and have read the manual.

Operating the Mower

1. Make sure the brake has been moved to the OFF Position.
2. Push down and hold the operator presence control levers on the handle bar with both hands.
3. The forward and reverse levers are spring loaded to the neutral position.
4. To drive the mower forward, slide both hands slightly back on the handle bar and gently squeeze the forward levers toward the handle bar. The forward speed is directly proportional to the degree these forward levers are moved toward the handle bar.
5. To turn the mower left, either release some pressure on the left lever (decreasing the speed of the left wheel), increase the pressure of the right lever (increasing the speed of the right wheel), or both. The degree of the turn is directly proportional to the amount of movement of these levers.
6. To turn the mower right, perform the lever movements described in step 5 above with the opposite levers.
7. To stop the forward motion of the mower, release the forward levers. The spring loaded feature of the hydrostatic drive returns the levers to the neutral position and stops the mower.
8. To drive the mower backwards, slide both hands slightly forward on the handle bar and gently press the reverse levers toward the handle bar.
9. When in the neutral position, the hydraulic system prevents the mower from moving easily. However, on a grade, the mower can move very slowly (with the engine off or running). Be sure to set the manual parking brake any time the mower is left unattended or is being transported.
10. To physically move the mower when the engine is NOT running, disengage the hydrostatic drive units.

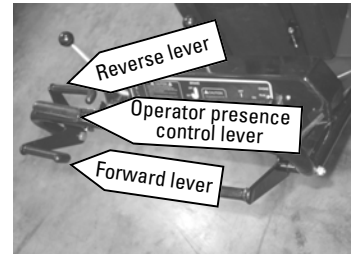

Disengaging Hydrostatic Drive Units

Before physically moving the mower when the engine is **NOT** running, the hydrostatic drive units need to be disengaged into free-wheel mode.

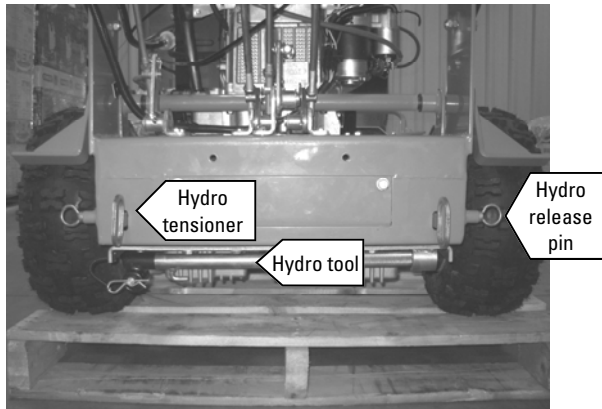

To disengage these hydro units:

1. Remove the hydro tool stored under the hydro unit.
2. Use the hook on the hydro tool to pull the hydro release pin back and out. Repeat on the other side. It may be necessary to bump the hydro carrier forward for easier free-wheeling.



CAUTION! Never bump, hit or push the actual hydros.

To return to operation mode:

1. Slide the hydro tool through the hydro tensioner. Pull until the pin sets. Repeat on the other side. If the pin partially sets, tap the pin.
2. Replace the hydro tool to storage under the hydro unit.



Return to Neutral

If the mower creeps or will not stop as desired when the handles are in neutral position, adjustments are necessary.

CAUTION: Be sure the engine is OFF before you open the hydro access panel.

1. Remove the bolts to access hydro panel.

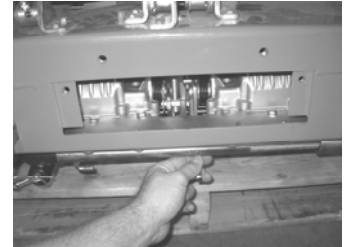

2. Using an 8 mm wrench, reach through the bottom of the hydro panel to the return-to-neutral set pin bolts. Loosen bolts on the side that needs adjusting.



3. Be sure the brake is in the OFF position. In a safe operator position, start the engine.
4. With the engine running, slowly move the handle on the side needing adjustment until that side comes to a complete stop. If the mower creeps forward, pull handle in reverse, If the mower creeps backward, pull the handle forward.
5. When the mower stops moving completely the hydro is in the neutral position.
6. Turn off the engine.
7. Slowly tighten the bolts without moving the plate.
8. With the bolts tightened, move to a safe operator position and start the engine.
9. If the creep has returned, repeat the process. Multiple iterations may be required.



DANGER! Make certain the engine comes to a complete stop before putting your hands in the access panel.

10. Reinstall hydro access panel.

Cutting Brush



Thoroughly inspect the area where you plan to use the mower. Look for items such as stones, sticks, wire, and other foreign objects. If struck by the mower, these and other objects may become projectiles that could lead to serious injury or death. Clear area of all debris.

Keep people and pets at a safe distance.



DANGER! Do not operate the mower with defective guards, shields, or without the safety devices securely in place.

1. When the mower is in position on the area to be mowed, hold the operator presence control down with one hand.
2. With the other hand, **SLOWLY** push the blade control lever forward to the ON position.

The Soft Start feature is critical to maintaining belt, clutch, and engine life. NEVER "slam" the blade on/off handle from off to on without pausing an adequate time in the soft start range.

3. Slowly, and evenly, engage the forward and reverse levers and begin mowing. To stop moving, ease up on the levers or simply let go of the controls.
4. To stop the blades, pull the blade control lever back to the OFF position.

WARNING—THE BLADES MAY TAKE UP TO 1.5 MINUTES TO STOP TURNING. DO NOT LEAVE THE OPERATOR'S ZONE OF THE MOWER UNTIL AFTER THE VISUAL WARNING DISK HAS STOPPED COMPLETELY.

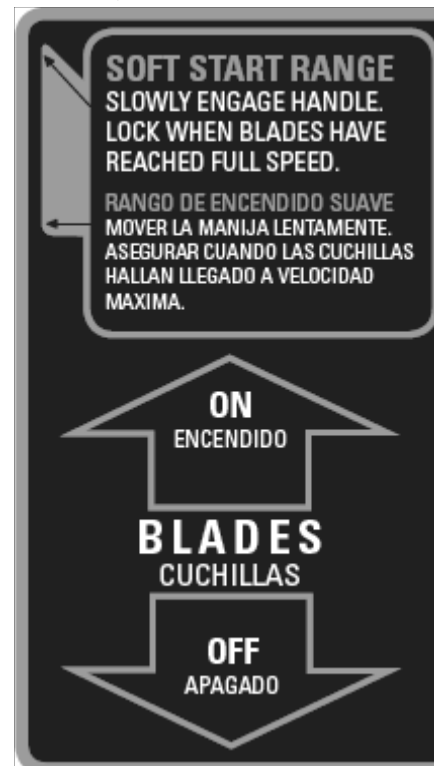
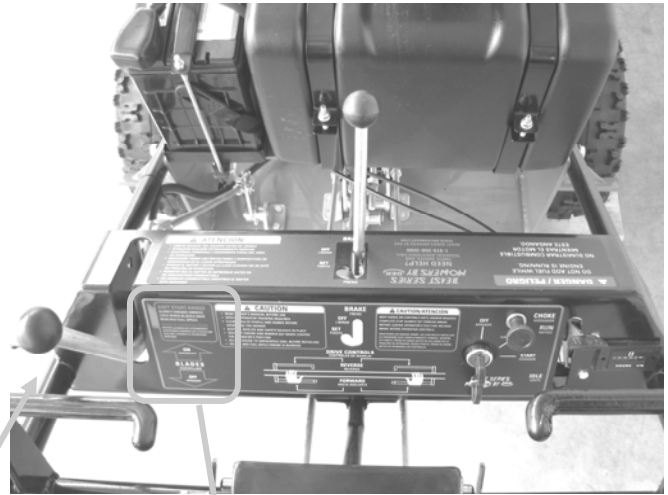

IMPORTANT! The brush mower blades do NOT stop quickly. Visual indication that the blades are turning is provided at the center of the belt guard. DO NOT approach the brush mower deck for service, cleaning, removing debris, or for any other reason until after the visual warning disk has stopped completely. Even at slow speeds the blades can cause serious injury or death.

Removing the Blades



Beware of the cutting edges on the blades. The rotation of one blade may cause the other blade(s) to rotate. Always wear work gloves when handling blades.

NOTE: Some of these steps require two people.

To change, sharpen, or service the blades in any way, it is not necessary to remove the spindle shaft and blade carrier. **Follow these steps if you are only removing the blades:**

1. Park the mower on a level surface, with the ignition switch off, the key removed, and the blades disengaged. Also, disconnect the spark plug wires from the spark plugs and ground them against the engine to prevent inadvertent starting. Block the rear wheels to prevent accidental rollback.
2. Remove the pulley guard and visual warning disk.
3. Remove the blade nut access cover located near the blade pulley.
4. Using a socket, extension, and pull handle remove the blade pivot retaining nut.
5. Remove the blade pivot. It may be necessary to tap the pivot out of the blade carrier. **Note:** If tapping is necessary, replace the nut on the blade pivot, without the locking washers, about half the thickness of the nut. Place a block of wood or other flat surface between the hammer and blade pivot and nut so the impact is flat. **ONLY** impact the nut, not the threads of the pivot.
6. Remove the blades and pivots from underneath the mower.
7. Perform the desired blade service. If you are replacing the blades, replacing the pivots is also recommended.
8. Replace the carrier protector, pivots, and blades making certain the keys are inserted in the pivots as they were removed. You will need assistance to start the nuts on the pivot bolts through the access hole.

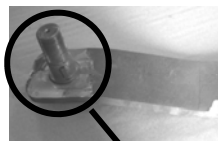
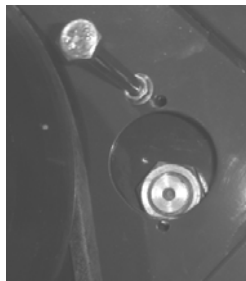

9. Tighten the blade pivot nuts properly.
10. Refasten the access hole cover to the deck to prevent debris from entering underneath the guard.
11. Inspect the work done to the blade system to make certain everything is properly secured. **Note:** Check to be sure blades rotate freely.
12. Replace the mower guard and the visual warning disk and secure both properly.
13. Start the engine and blades safely and properly. If any unusual noises or vibrations are present, **SHUT THE MOWER DOWN IMMEDIATELY.**

REPLACE THE BLADE SYSTEM IF ANY PART APPEARS TO BE WORN OR DAMAGED IN ANY WAY. DO NOT USE THE MOWER WITH ANY PART OF THE BLADE SYSTEM DAMAGED. BLADES MUST BE REPLACED IN PAIRS TO PREVENT VIBRATION.

To disassemble the blade carrier, spindle shaft, and spindle, follow steps 1 through 6 to remove the blades and then proceed with the following additional steps:

1. Insert a pipe or rod through the access hole and the blade carrier hole.
2. Loosen the spindle shaft retaining nut on the top of the pulley. Have an assistant hold the pipe or rod upright while loosening the bolt. **DO NOT** allow the rod to tilt and become jammed from the blade carrier turning motion.
3. Raise the front end of the mower using a jack and secure the mower with jack-stands.
4. Remove the spindle shaft retaining nut. You will need to hold the shaft on the bottom side. **CAUTION:** The blade carrier is heavy. When the nut is removed the blade carrier can slide out of the spindle easily.
5. After servicing and inspecting the spindle, replace the carrier and spindle shaft, and start the nut on top to prevent the carrier from falling out. This will require two people.
6. Place the pipe back through the access hole, and tighten the spindle shaft retaining bolt.
7. Using a jack, lower the brush mower back to the ground.



The Importance of Maintenance

Regular maintenance is essential to ensure your brush mower continues to deliver safe and high-quality performance.

To help you properly care for your brush mower, the following pages include a recommended maintenance schedule, routine inspection procedures, and simple maintenance procedures using basic hand tools. Maintenance is the responsibility of the owner and must be performed regularly. More difficult service tasks or tasks that require special tools are best handled by a recommended service technician or other qualified mechanic.

The maintenance schedule described on page 15 applies to mowers used under normal operating conditions. If you operate your brush mower under severe conditions, such as sustained prolonged use or high-temperature operations, or use it in unusually wet, dusty or rocky conditions, consult your servicing dealer for recommendations applicable to your individual needs and use.

Be sure to use genuine BRUSH BEAST mower replacement parts when servicing your mower to assure the best quality, safety and performance.

Need Help? Parts, Service and Technical Assistance
Call: 1-919-550-3221 www.brushbeast.com



CAUTION: Before making any adjustments and/or servicing to your BRUSH BEAST mower, make sure the mower is on a level surface, with the ignition switch off, the key removed, and the blades disengaged. Also, disconnect the spark plug wires from the spark plugs and ground them against the engine to prevent inadvertent starting.

If you are performing adjustments or maintenance after operating the mower, allow the unit to cool since heat build up could cause severe burns.

Tire Pressure

Incorrect tire pressure may cause the mower to pull to one side and/or result in uneven cut. Use caution when filling the tires. NEVER exceed the recommended 24 PSI.

Air Filter

Refer to the Engine Owner's Manual for the recommended maintenance.

Fuel



DANGER: Gasoline is highly flammable and explosive. Do not add fuel while the engine is running or is hot. Keep open flames, sparks, and heat away from the fuel and store fuel in containers specifically designed for that purpose. Add fuel outdoors only and if the fuel is spilled, do not start the engine. Manually push the mower away from the spill and wipe up immediately.

Refer to the Engine Owner's Manual for the type of fuel to use.

A fuel shut off valve is located on the bottom of the fuel tank. It is recommended that the fuel be shut off when transporting between job sites and when storing the mower for extended periods of time.

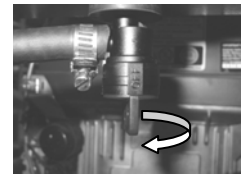

Engine Oil

CHECK ENGINE OIL BEFORE EACH USE. Refer to the Engine Owner's Manual for the type of oil to use, oil change intervals, and the proper procedures to check and change oil.

Blades



CAUTION: Always wear work gloves when performing blade maintenance and beware of the cutting edges. Be sure the engine is off, the key removed, and the spark plug wires are disconnected from the spark plugs to prevent inadvertent starting.

Inspect blades on a daily basis for nicks, bends, and excessive wear. If the blades are worn, cracked, bent, or damaged, replace them before using the mower. Choose genuine BRUSH BEAST mower replacement blades to ensure quality and performance. (See page 12 for blade removal instructions.)

When sharpening the blades, sharpen only the cutting edges and try to maintain the original angle of the blade. Do not make the cutting edge razor sharp. Remove the same amount from each side of the blade so that balance is maintained.

Item	Procedure	Time Interval				
		Break-in (first 5 hrs)	Every 8 hrs (daily)	Every 40 hrs (weekly)	Every 100 hrs (Bi-weekly)	Every 200 hrs (monthly)
Belts	Inspect (adjust if needed)	X	X			
Blades	Inspect and Sharpen		X			
Engine Air Filter	Inspect (see Engine Owner's Manual)		X			
Engine Cooling Areas	Clean (see Engine Owner's Manual)				X	
Engine Oil	Check (see Engine Owner's Manual)		X			
	Change (see Engine Owner's Manual)	X		X		
Engine Oil Filter	Change (see Engine Owner's Manual)	X				X
Engine Spark Plugs	Inspect (see Engine Owner's Manual)					X
Fuel Filter	Replace				X	
Fuel Line	Check				X	
Grease Fittings	Refer to page 18					
Hardware	Check for proper tightness	X		X		
Mower Main Frame	Remove debris from under belt cover		X			
Safety Interlock System	Check Operations and Switches		X			
Tires	Check Air Pressure			X		

Cleaning the Mower

It is recommended that the BRUSH BEAST mower be cleaned on a daily basis. Excessive accumulation of dirt, debris, oil, etc., causes premature wear on the components and may present a potential safety hazard.



DANGER: Before making any adjustments or servicing your brush mower, make sure the brush mower is on level ground, the blades are disengaged, the key is removed, the engine is off and the spark plug wires are disconnected from the spark plugs to prevent accidental contact. If maintenance or adjustments are being performed after operation of the brush mower, allow the unit to cool since heat build up could cause severe burns.

Engine-to-Blade Belt Adjustment

1. Remove the deck cover and move the blade control lever on the control console to the ON position.
2. With approximately 10 pounds of pressure, push the clutch pulley to tighten the belt. The linkage should stop approximately 1 inch before contacting the stop bolt. If the belt moves more than ½-inch, move the blade control lever back to the OFF position.

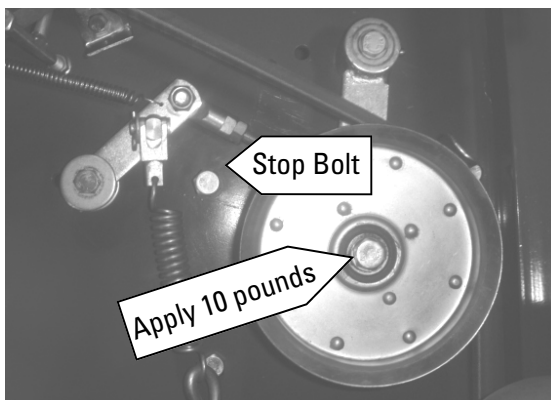

IMPORTANT! The brush mower blades do NOT stop quickly. Visual indication that the blades are turning is provided at the center of the belt guard. DO NOT approach the brush mower deck for service, cleaning, removing debris, or for any other reason until after the visual warning disk has stopped completely. Even at slow speeds the blades can cause serious injury or death.

3. Loosen locking nut.
4. Rotate turnbuckle until desired tension is achieved (approximately 1 inch from stop bolt).
5. Tighten locking nut when finished.
6. Replace deck cover.

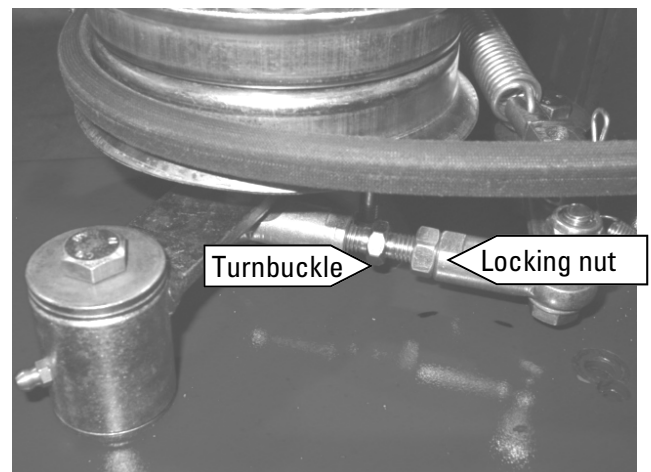

Engine-to-Hydrostatic Drive Belt Adjustment

1. The engine-to-hydrostatic drives belt is located underneath the rear deck. The belt should move approximately 5/16-inch to 3/4-inch with three (3) to five (5) pounds of pressure applied to the belt midway between the transmission pulley and the engine output shaft pulley. When installing a new belt, the tension should be higher than the running tension. It is not necessary to keep the belt at the greatest (smallest deflection) tension during normal operation. **Important:** Do not over-tighten the belt.

2. To adjust the belt, turn the nut on the threaded tension rod found on the right, rear corner of the mower.

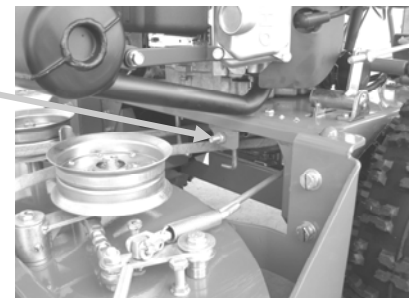

3. Do not over-tighten. This could cause serious damage to the hydraulic drive systems.

Safety System Adjustments



WARNING: Do not bypass, modify, alter, or disconnect the safety system. Make sure that the safety interlock system is fully operational each time before mowing. Failure to do so could present danger to you and others around you.

There are generally three (3) ways to adjust the sensitivity of a safety switch. The most appropriate way to adjust each switch depends upon the application, location, and the nature of the problem you are encountering.

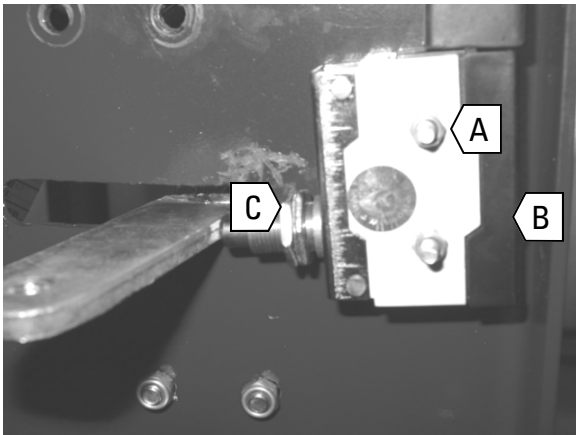

Method 1: Adjust location using the mounting screws

1. Move the blade control lever to OFF.
2. Loosen screws (A) until safety switch (B) moves freely.
3. Slide safety switch (B) firmly against blade bell crank (C).
4. Tighten screws (A) and check that safety switch (B) does not move.

Method 2: Adjust location using adjustment nuts on switch body

1. Loosen locking nut (C) on the sensor shaft.
2. Adjust switch location by turning the nuts.
3. Tighten the locking nut when proper adjustment is achieved.

Method 3: Relocate mounting holes

In rare cases where the components become misaligned, the easiest means of adjusting the location is to elongate the existing holes or add new holes to achieve a tighter fit between the activation rod and the sensor.

Hydro System Maintenance

The hydrostatic drives are coupled to the output drives with a multi-v belt. Occasional retensioning of the belt may be necessary. If performance decreases or hydro control handles are activated and the wheels do not turn, inspect the multi-v belt.

1. Remove the hydro access panel.

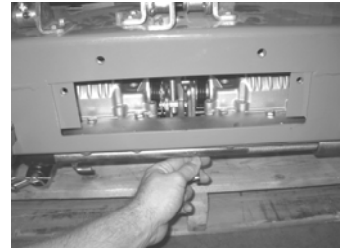

2. Loosen jamb nut at hydro tensioner.



3. Tighten nut to tighten belt. Belt tension should be 1/16-inch deflection under seven (7) of pressure.
4. Once tension is set, tighten the jamb nut and reinstall the hydro access panel.



DANGER: Before making any adjustments or servicing your brush mower, make sure the brush mower is on level ground, the blades are disengaged, the key is removed, the engine is off and the spark plug wires are disconnected from the spark plugs to prevent inadvertent starting. If maintenance or adjustments are being performed after operation of the brush mower, allow the unit to cool since heat build up could cause severe burns.

To ensure proper lubrication of moving parts, GXi recommends that you lubricate the following components with a high-quality, EP2 high-temperature-based grease or equivalent. Should the conditions of operation be more severe than normal, the lubrication interval may need to be shortened. GTR/OPE grease is the recommended lubricant.

Lubrication Point Locations

BRUSH BEAST mowers have four (4) lubrication points.

Note: The brush mower spindle bearings are both sealed top and bottom to prevent contaminants from entering the spindle. There is no service point on the spindle.

Lubricate after every 50 hours of usage

Mower deck idler pulley brackets (1 location)

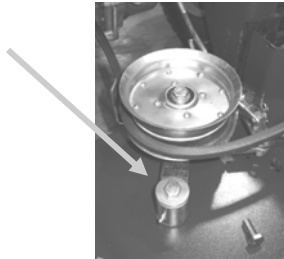

- Blade activation rod supports (2 locations: one at the support under the fuel tank bracket and one adjacent to the engine.)



- Hydraulic drive system idler puller support (1 location)

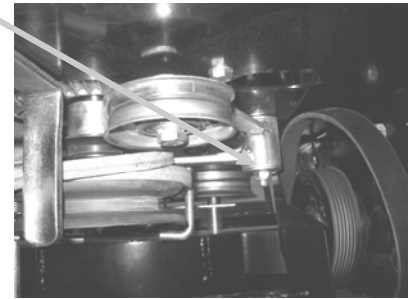

Deck Interchange

Note: Be sure the hydro unit is disengaged (see page 11) before interchanging the optional attachment deck.

- Remove the deck cover by releasing the three (3) T-handles.

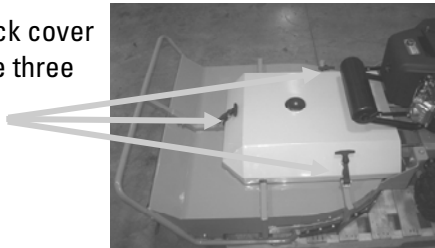

- Disconnect the clutch tension rod connecting the deck to the chassis.



- Remove the belt from the engine pulley.

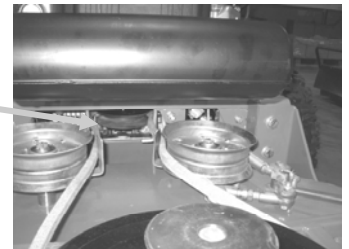

- Using an 18 mm wrench or socket, remove the four (4) deck retaining bolts.

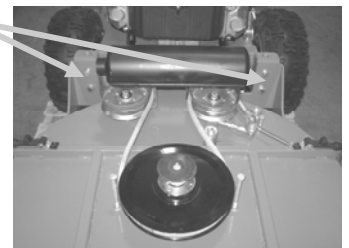

- Tilt handle bars forward and pull chassis from deck.
- Reverse the steps to reconnect the optional attachment deck. Refer to the owner manual supplied with the optional deck for assembly and operation instructions.

Problem	Possible Causes	Solution
Engine will not start	<ol style="list-style-type: none"> 1. Key in the OFF position 2. Insufficient fuel in the tank 3. Air bubble in the fuel line 4. Fuel valve in OFF position 5. Choke not ON 6. Choke linkage out of adjustment 7. Low engine oil 8. Blade control in ON position 9. Loose spark plug wire 10. Fouled spark plug 11. Plugged or dirty air filter 12. Bad gasoline 13. Plugged or dirty fuel filter 14. Safety switches out of alignment or loose 15. Dead battery (electric start models) 	<ol style="list-style-type: none"> 1. Turn key to ON position 2. Add gasoline 3. Prime engine or shake bubble out 4. Turn valve ON 5. Turn choke ON 6. Refer to Engine Owner's Manual 7. Add engine oil 8. Push lever to OFF position 9. Tighten wire or connections 10. Clean or replace the plug 11. Clean or replace the air filter 12. Drain and replace the gasoline 13. Replace the fuel filter 14. Adjust or tighten switches (p. 17) read warnings! 15. Recharge or replace battery <p><i>To test whether the blade activation safety switches are a contributing factor to the engine not starting, depress the Operator Presence Switch on the handle bars while trying to start the engine. If engine starts, a safety switch adjustment is required.</i></p>
Engine will not keep running/quits	<ol style="list-style-type: none"> 1. Water in the fuel 2. Loose safety switch 3. Fuel valve is OFF 4. Dirty fuel filter 5. Dirty air filter 6. Low engine oil 	<ol style="list-style-type: none"> 1. Drain and replace fuel 2. Adjust switch (p. 17) 3. Turn fuel valve ON 4. Replace fuel filter 5. Clean or replace air filter 6. Add engine oil
Engine stops when blades are engaged	<ol style="list-style-type: none"> 1. Loose safety switch 2. Belt tension too high 3. Blades jammed with foreign material 	<ol style="list-style-type: none"> 1. Adjust switch (p. 17) 2. Adjust belt (p. 16) 3. Remove foreign material <p>Note: Firmly pushing the blade control lever into the OFF position to ensure the safety switch is fully engaged can sometimes resolve this problem.</p>
Blades do not turn	<ol style="list-style-type: none"> 1. Broken belt 2. Loose belt 3. Blade activation linkage out of adjustment. 	<ol style="list-style-type: none"> 1. Replace belt 2. Adjust belt (p. 16) 3. Adjust linkage (p. 13)
Belts squeal when blades are engaged	<ol style="list-style-type: none"> 1. Incorrect belt tension 2. Excessive belt wear 	<ol style="list-style-type: none"> 1. Adjust belt tension 2. Replace belt
Belts slip when blades are engaged	<ol style="list-style-type: none"> 1. Incorrect belt tension 2. Excessive belt wear 	<ol style="list-style-type: none"> 1. Adjust belt tension 2. Replace belt

Problem	Possible Causes	Solution
Mower will not move forward or reverse	<ol style="list-style-type: none"> 1. Brake ON 2. Bypass levers pulled out 	<ol style="list-style-type: none"> 1. Release brake on control panel 2. Ensure bypass pins are retracted
Cannot move mower when the engine is off	<ol style="list-style-type: none"> 1. Bypass not engaged 	<ol style="list-style-type: none"> 1. Pull left and right bypass pins and set them in slots in the chassis (p. 11)
Engine is overheating	<ol style="list-style-type: none"> 1. Dirt in the fuel line 2. Dirty air filter 3. Low engine oil 4. Fouled spark plug 5. Misuse of the mower 6. Dull blades 7. Spindle bearing failure 	<ol style="list-style-type: none"> 1. Replace fuel filter and flush tank 2. Clean or replace the air filter 3. Add engine oil 4. Replace spark plug 5. Mow slower, wait for grass to dry out 6. Sharpen cutting blades 7. Take in for service
Grass not cut smoothly or cleanly	<ol style="list-style-type: none"> 1. Dull blades 2. Mowing too fast for conditions 3. Grass is wet or bent over 4. Blades are bent 5. Tire pressure not equal 6. Deck is set at uneven heights 7. Blades are set upside down 8. Excessive grass and debris build up underneath the deck 	<ol style="list-style-type: none"> 1. Sharpen blades 2. Slow down while cutting 3. Let grass dry to stand up 4. Replace blades in sets 5. Add air pressure to low tires 6. Set deck at equal heights 7. Take blades off and install correctly 8. Clean out debris
Mower always pulls to one side	<ol style="list-style-type: none"> 1. Controls out of adjustment 2. Transmission failure 	<ol style="list-style-type: none"> 1. Adjust controls (p. 11) 2. Take in for service

Products Covered by this Warranty	Length of Warranty: *(from the date of original retail purchase)		
	Residential	Commercial	Rental
Engine	Manufacturer's warranty	Manufacturer's warranty	Manufacturer's warranty
Transmission	Manufacturer's warranty	Manufacturer's warranty	Manufacturer's warranty
Mower frame	Lifetime (original owner only)	Lifetime (original owner only)	90 days
Belts, Tires, Battery	90 days	90 days	90 days
Attachments	1 yr limited	1 yr limited	30 day limited

*LENGTH OF WARRANTY: Batteries supplied with applicable products as standard, original equipment are covered by this warranty for a period of 90 days from the date of original retail product purchase. Consumable parts such as oil, spark plugs, filters, and blades are not covered by this warranty.

To Qualify for this Warranty

The product must be purchased in the United States from a dealer authorized by GXi Outdoor Power, LLC to sell those products. This warranty applies to first retail purchaser/owner during the applicable warranty time period. **NO WARRANTY REGISTRATION IS NECESSARY TO OBTAIN WARRANTY ON BEAST PRODUCTS. SAVE YOUR PROOF OF PURCHASE RECEIPT. MUST HAVE PROOF OF PURCHASE TO OBTAIN WARRANTY.**

What GXi Outdoor Power Will Repair or Replace under Warranty

GXi will repair or replace, at its option, any part that is proven to be defective in material or workmanship under normal use during the applicable warranty time period subject to the exclusions stated herein. This warranty is void if the owner fails to follow the prescribed maintenance and operating procedures described in this manual. This specifically refers to ensuring routine lubrications and oil changes are made, that fuel stabilizer is used when the product is stored and that the product is not overloaded.

GXi has the right to recover warranty administration costs from the owner if the root cause of the malfunction is found to be other than defective material or workmanship. In particular, this warranty does not cover: contaminants in the fuel or oil; damage caused by not following the prescribed warnings and operating practices; failure to follow proper maintenance and storage procedures; and physical damage due to misuse, shipping, handling or storage.

Warranty repairs will be made without charge for parts and labor for the first year.

Anything replaced under warranty becomes the property of GXi. Parts replaced under warranty will be considered as part of the original product and any warranty on those parts will expire coincident with the original product warranty.

To Obtain Warranty Service

You must take the BEAST product, accessory, replacement part, apparel or the power equipment on which the accessory or replacement part is installed, and proof of purchase, at your expense, to any BEAST service location in the United States, who is authorized to service that product, during the service location's normal business hours. If you are unable to obtain warranty service, or are dissatisfied with the warranty service you receive, take the following steps: First, contact the manager of the service center involved; normally this will resolve the problem. However, if you should require further assistance, write or call the GXi Parts & Service, LLC 1-919-550-3221

Exclusions

This warranty does not cover: normal wear, contaminants in the fuel or oil; damage as a result of use in an application for which the product was not designed; damage caused by incorporation or use of unsuitable attachments or parts, unauthorized alteration, or other misuse and neglect; damage caused by failure to follow the prescribed warnings, operating practices, proper maintenance and storage procedures; parts affected or damaged by accident and/or collision; damage due to shipping, handling, storage or any causes other than defects in material or workmanship of the product.

Disclaimer of Consequential Damage and Limitation of Implied Warranties

GXi disclaims any responsibility for loss of time or use of the product, transportation, commercial loss, or any other incidental or consequential damage. Any implied warranties are limited to the duration of this written limited warranty.

THIS WARRANTY IS VOID IF THE MANUFACTURING DATE AND THE SERIAL NUMBER ON THE EQUIPMENT HAS BEEN REMOVED OR THE EQUIPMENT HAS BEEN MODIFIED.