

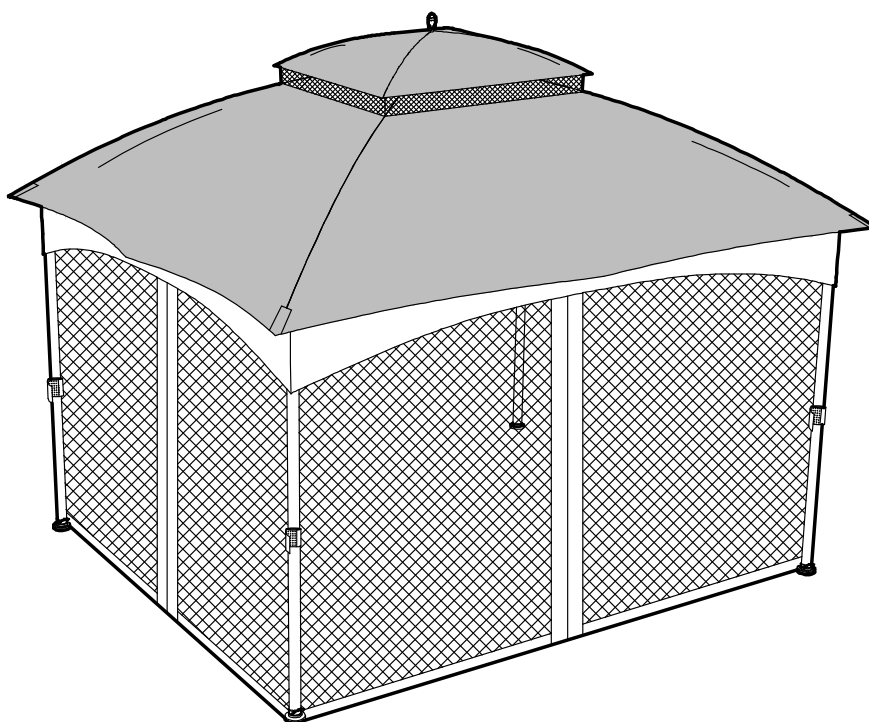

Item # 1002 060 483  
Model # L-GZ933PST

## USE AND CARE GUIDE

### MASSILLON GAZEBO



Questions, problems, missing parts? Before returning to the store,  
call Hampton Bay Customer Service  
8 a.m. - 7 p.m., EST, Monday-Friday, 9 a.m. - 6 p.m., EST, Saturday

**1-855-HD-HAMPTON**

**HAMPTONBAY.COM**



To view an instructional video on how install this product:

1. Go to [www.homedepot.com](http://www.homedepot.com) and enter either the Item or Model number found in top right corner of this instruction sheet in the search field.
2. Click on your product from the list of search results and click on the video link in the product overview section.

#### **THANK YOU**

*We appreciate the trust and confidence you have placed in Hampton Bay through the purchase of this gazebo. We strive to continually create quality products designed to enhance your home. Visit us online to see our full line of products available for your home improvement needs. Thank you for choosing Hampton Bay!*

# Table of Contents

Table of Contents.....	2	Hardware Included.....	3
Safety Information.....	2	Tools Needed .....	4
Warranty.....	2	Important .....	4
What is Covered .....	2	Package Contents .....	5
What is Not Covered .....	2	<b>Assembly</b> .....	<b>8</b>
Pre-Assembly .....	3	<b>Care and Cleaning</b> .....	<b>16</b>
Planning Assembly.....	3		

# Safety Information

1. More than four people are required for this assembly.
2. Some parts may contain sharp edges. Wear protective gloves.
3. When assembling and using this product, basic safety precautions should always be followed to reduce the risk of personal injury and damage to equipment. Please read all instructions before assembly and usage.



**DANGER:** This unit is heavy! Do not assemble this item alone.



**WARNING:** Do not leave the gazebo where there is a risk of high wind, as possible damage will occur to the structure.



**WARNING:** Keep all flame and heat sources away from this gazebo fabric. This Gazebo is made with fabric that meets CPAI-84 specifications for flame resistance. It is not fire proof. The fabric will burn if left in continuous contact with any flame source. The application of any foreign substance to the gazebo fabric may render the flame-resistant properties ineffective.



**CAUTION:** Do not climb on top of the gazebo. Falling off the gazebo can result in serious injury, possibly even death.

**NOTICE:** For outdoor use only.

# Warranty

## 2 YEAR WARRANTY

### WHAT IS COVERED

This limited warranty is extended to the original purchaser and applies to defects in materials and workmanship of your item provided the item is maintained with care and used only for personal, residential purposes. The item is warranted to be free from defects in material or workmanship for a period of 2 years.

### WHAT IS NOT COVERED

We do not reimburse for transportation of delivery costs, or compensate the individual or any outside party for assembling or disassembling the product.

Contact the Customer Service Team at 1-855-HD-HAMPTON or visit [HAMPTONBAY.COM](http://HAMPTONBAY.COM).

Production Number: 20180699

# Pre-Assembly

## PLANNING ASSEMBLY

Before beginning assembly of this product, make sure all parts are present. Compare parts with the Hardware Included and Package Contents lists. If any part is missing or damaged, do not attempt to assemble the product. Contact customer service for replacement parts.

## HARDWARE INCLUDED



**NOTE:** Hardware not shown to actual size. To avoid destroying the finish, do not put the parts on the ground directly.

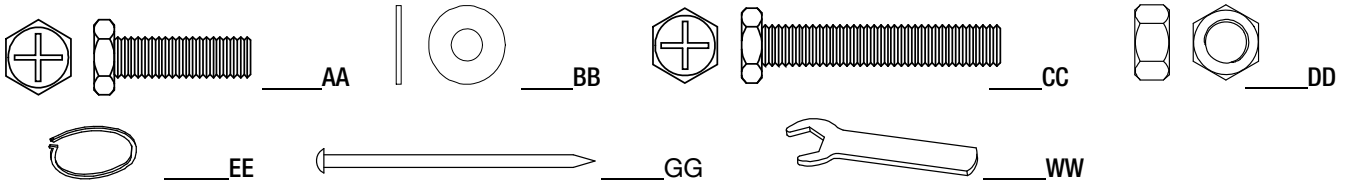

Part	Part No	Description	Quantity	Add
AA	H02020C11	Bolt M6*20	48	5
BB	H19001C11	Flat Washer M6	72	8
CC	H02035C11	Bolt M6 *35	8	2
DD	H14001C11	M6 Nut	16	3
EE	P90701A07001	Ring	52	6
GG	P12401A01001	Stake $\Phi$ 8*180	12	0
WW	H00001C12	Wrench	2	0

## Pre-Assembly (continued)

### TOOLS NEEDED

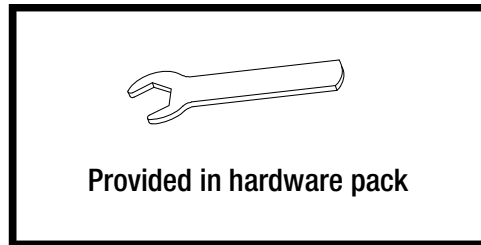
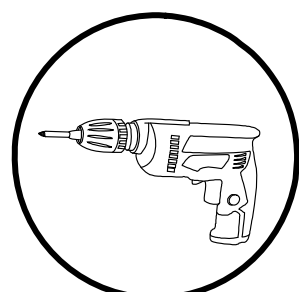
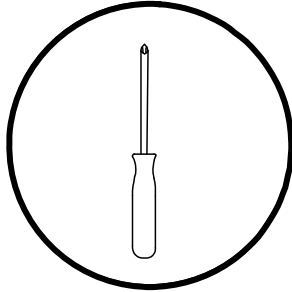
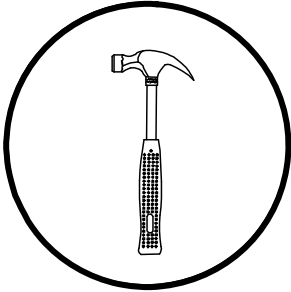

### IMPORTANT

Requires 2 persons for the installation work. Approximate installation time: 2~3 hours.

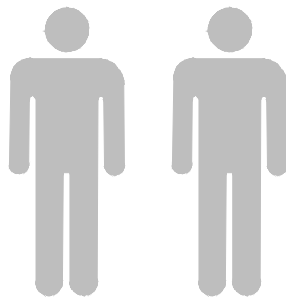





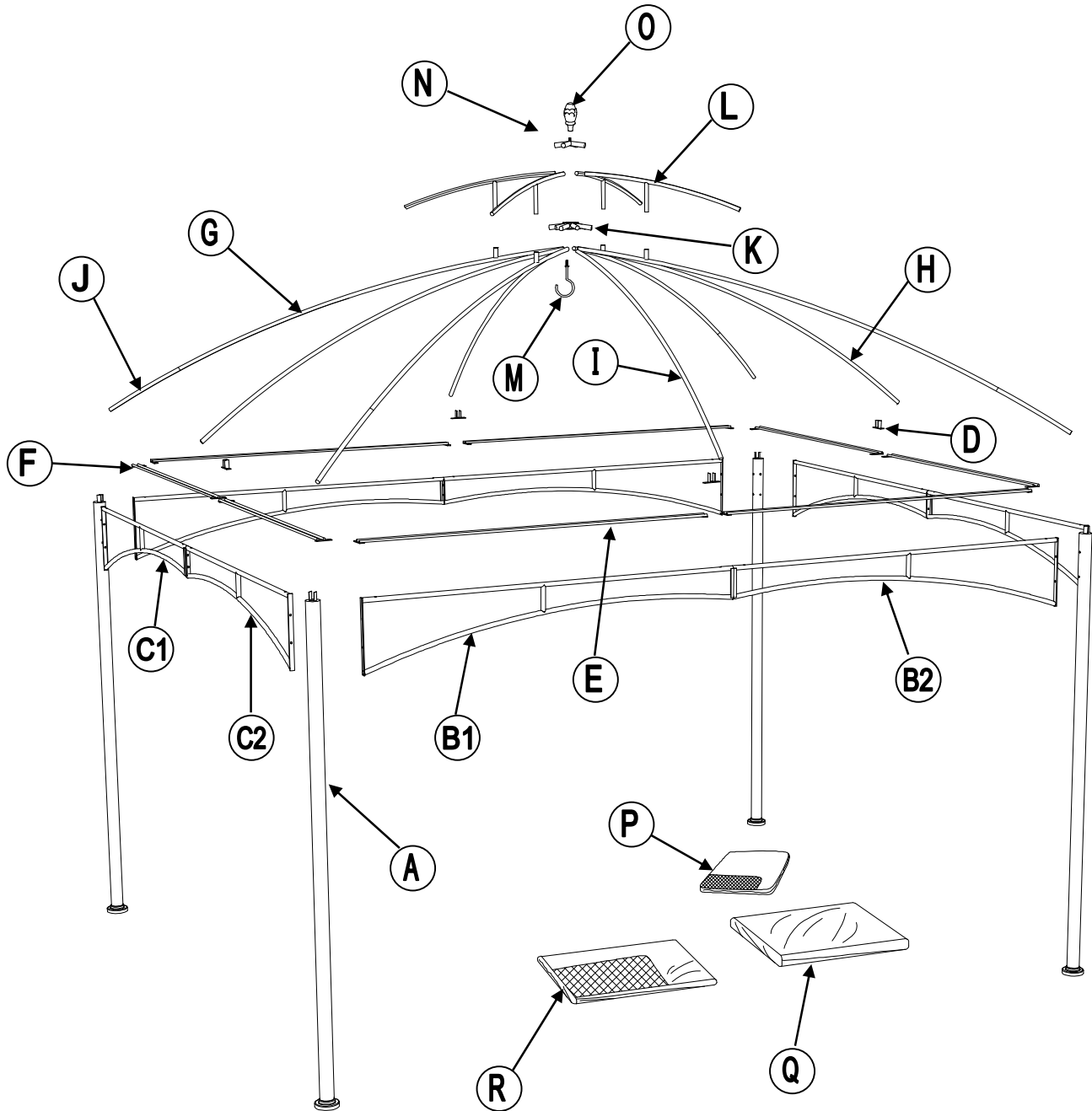

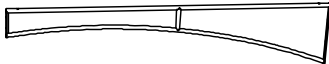
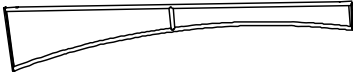

# Pre-Assembly (continued)

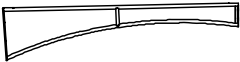





## PACKAGE CONTENTS

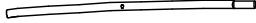
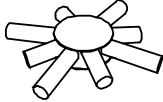

## Pre-Assembly (continued)

Label	Part Number	Description	Qty	Part Image
A	P11103B01106	Post	4	
B1	P11001D01106	Long Left Frame	2	
B2	P11002D01106	Long Right Frame	2	
C1	P11003D01106	Short Left Frame	2	
C2	P11004D01106	Short Right Frame	2	
D	P10801B01106	Middle Board Connection	4	
E	P12101B01106	Long Mosquito Netting Bar	4	
F	P12102B01106	Short Mosquito Netting Bar	4	
G	P10301D01106	Oblique Board	4	
H	P10401C01106	Long Middle Board	2	

## Pre-Assembly (continued)

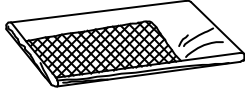
I	P10402C01106	Short Middle Board	2	
J	P10302D01106	Tube Under Oblique Board	4	
K	P10101D01106	Big Top Connector	1	
L	P10201C01106	Slant Beam For Small Roof	4	
M	P12601C01106	Hook	1	
N	P10102D01106	Small Top Connector	1	
O	P10001C01106	Decoration	1	
P	P00105B06005	Small Canopy	1	
Q	P00106B06005	Big Canopy	1	
R	P00303B01909	Mosquito Netting	1	

# Assembly

## STEP 1: Connecting the Long Frames

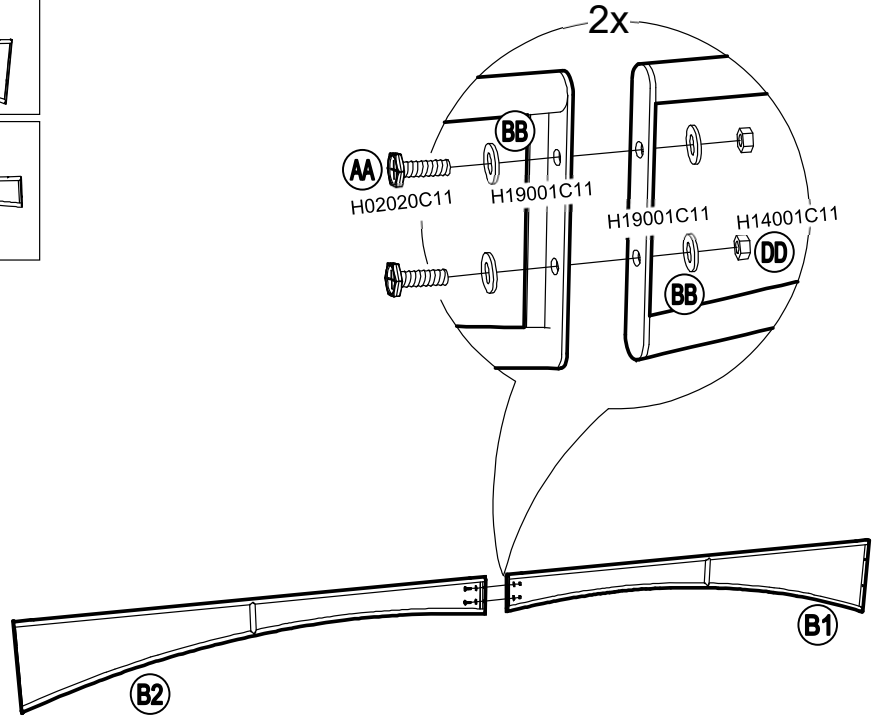
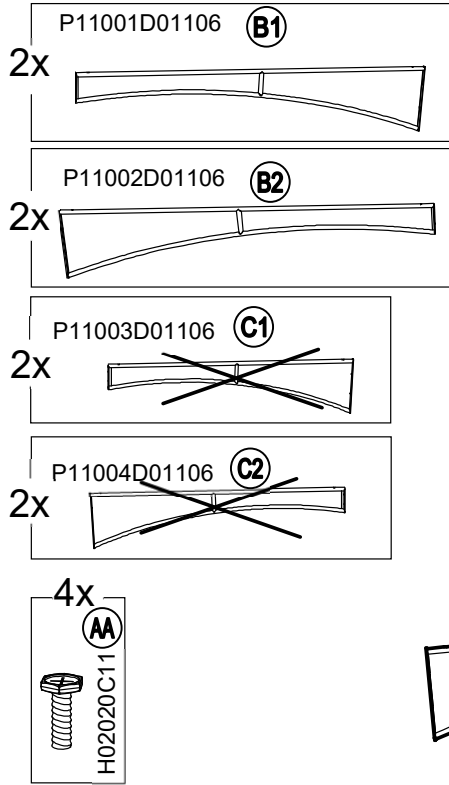

## STEP 2: Connecting the Short Frames

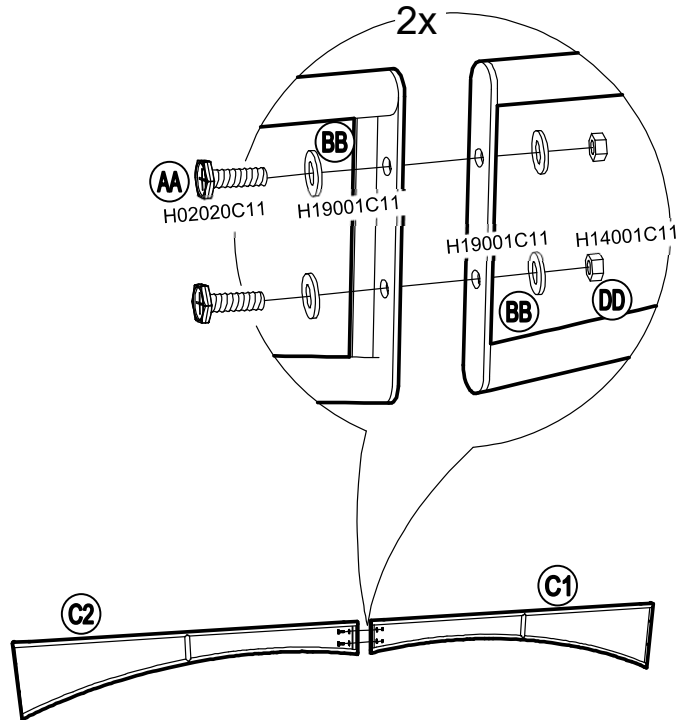
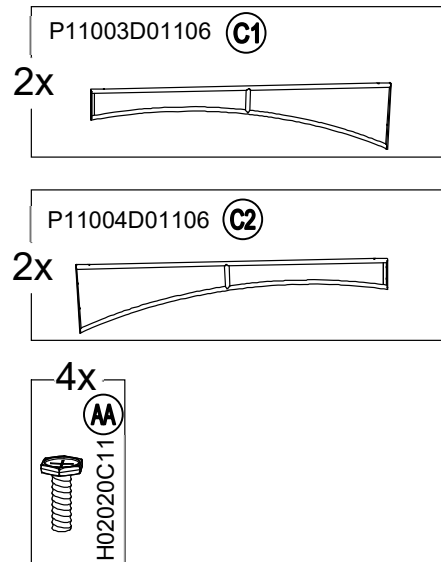



# Assembly (continued)

## STEP 3: Attaching the Mosquito Netting Bar

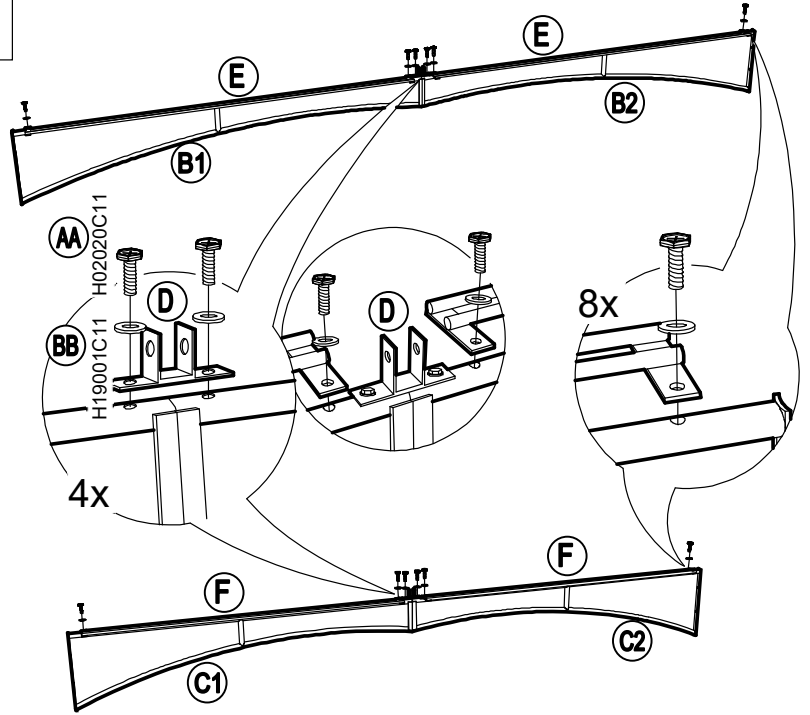
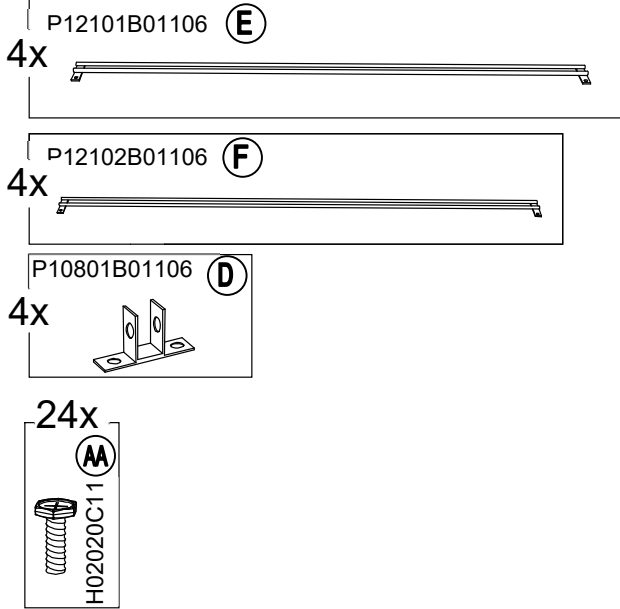

## STEP 4: Attaching the Long Frames to the Post

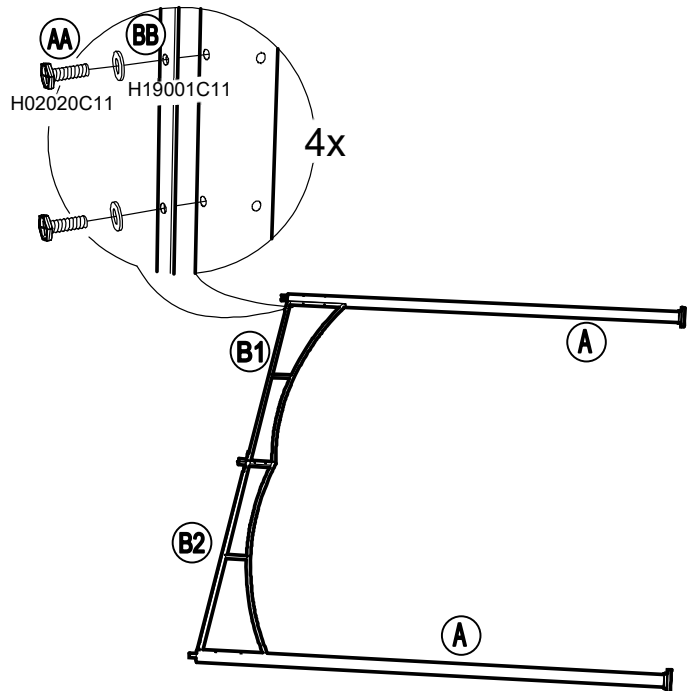
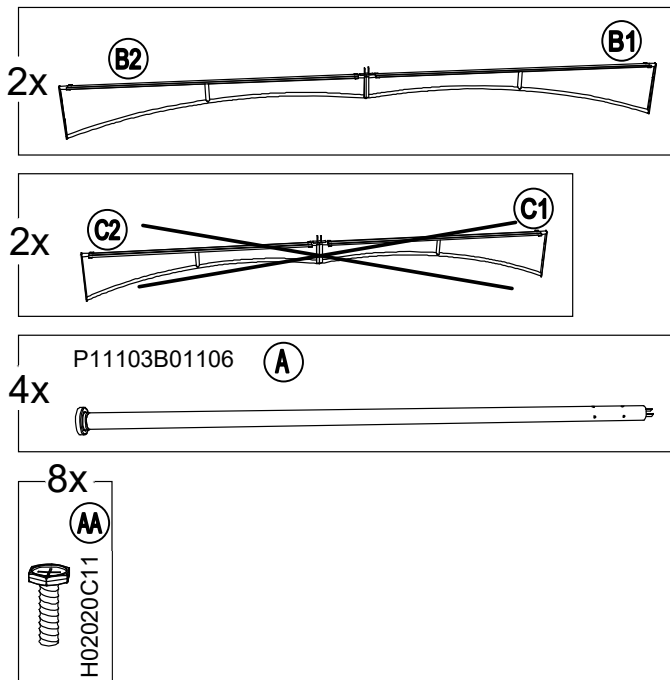

# Assembly (continued)

## STEP 5: Attaching the Short Frames to the Post

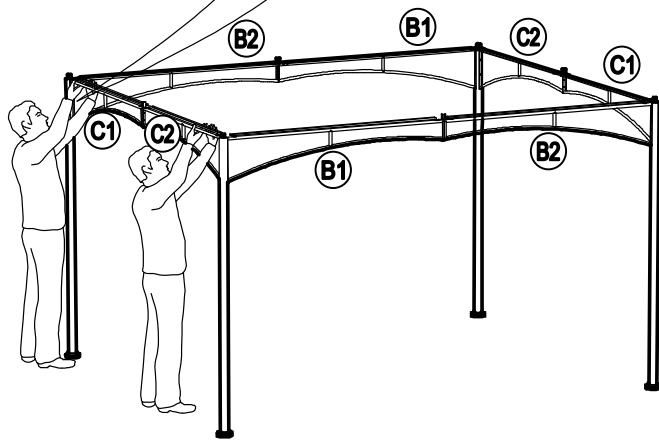
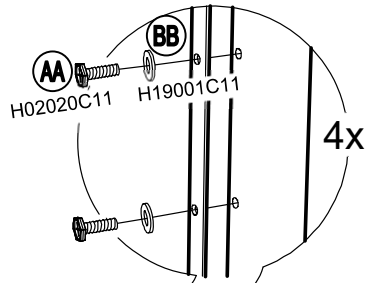
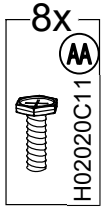
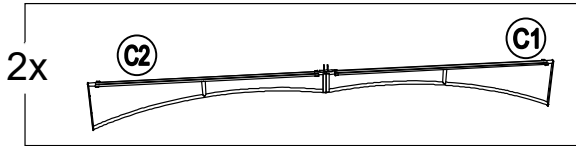

## STEP 6: Attaching the Oblique Boards

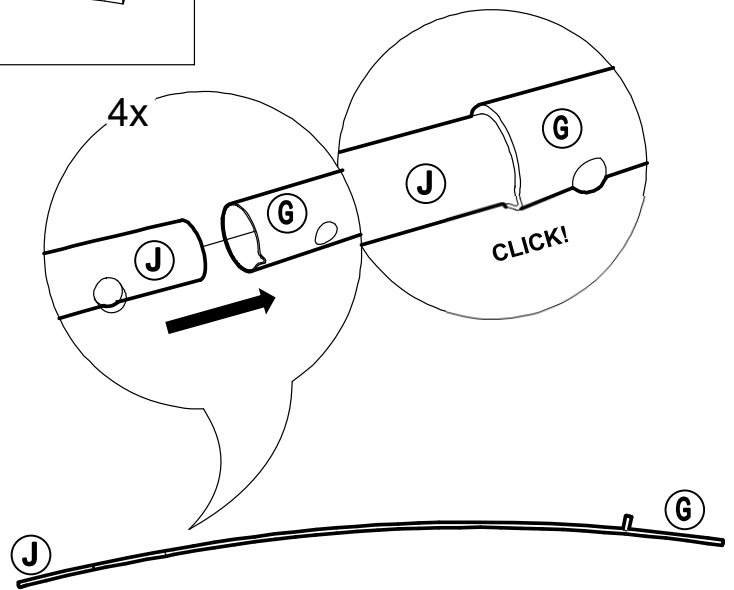
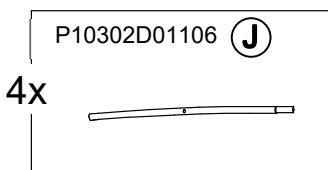
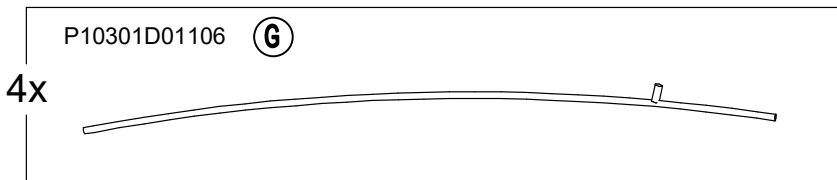

# Assembly (continued)

## STEP 7: Attaching the Big Top Connector to the Oblique Boards

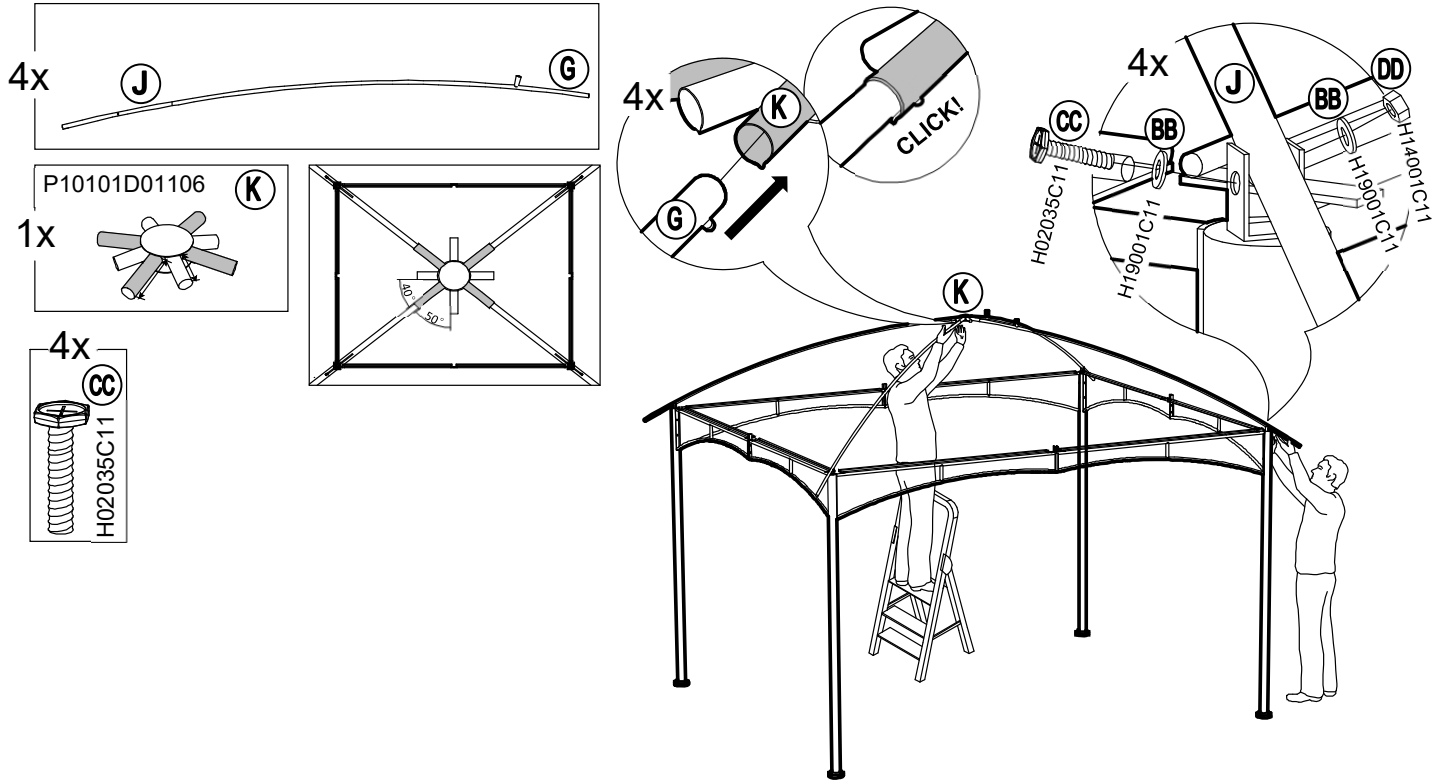

## STEP 8: Attaching the Middle Boards to the Big Top Connector

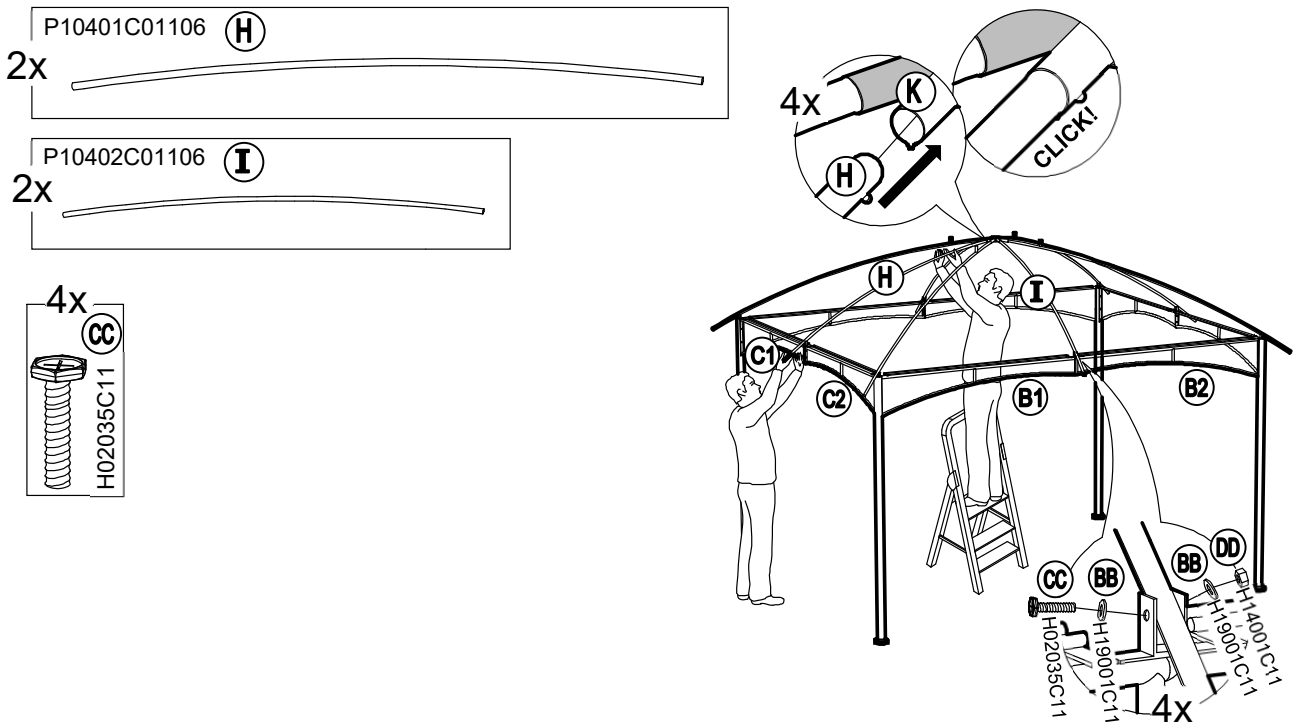

# Assembly (continued)

## STEP 9: Attaching the Big Canopy

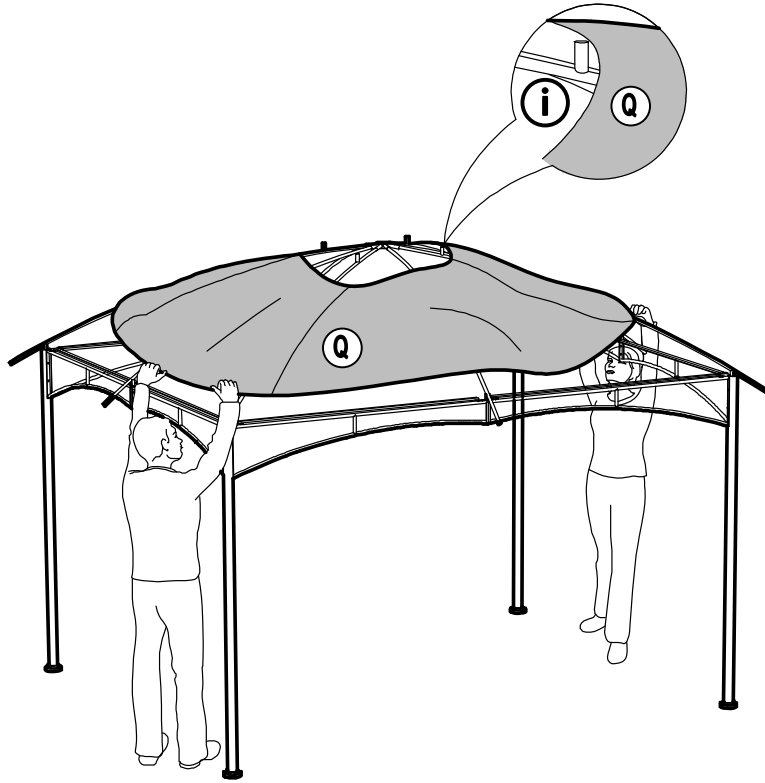
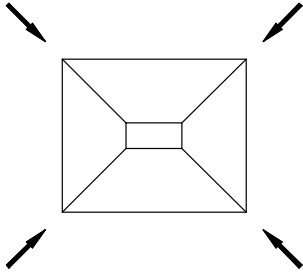
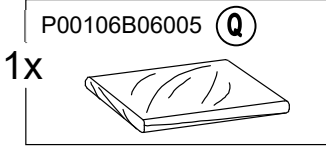

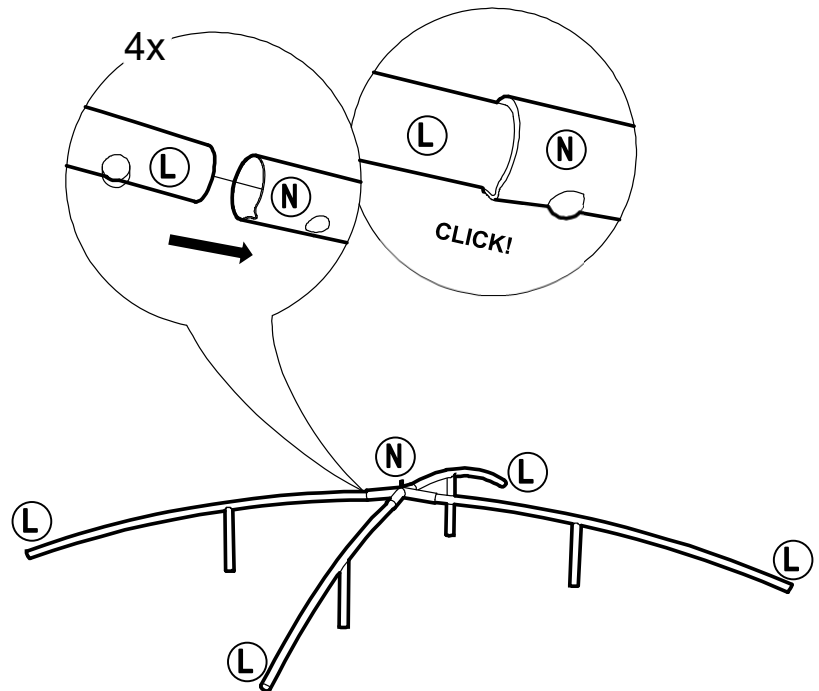
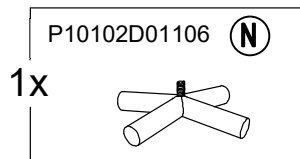
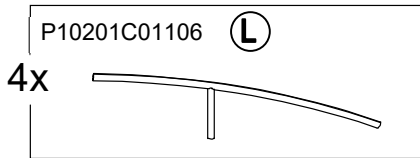

## STEP 10: Attaching the Slant Beam For Small Roof



# Assembly (continued)

## STEP 11: Attaching the Small Canopy

- P10001C01106 (O) 1x 
- P00105B06005 (P) 1x 
- P00303B01909 (R) 1x 

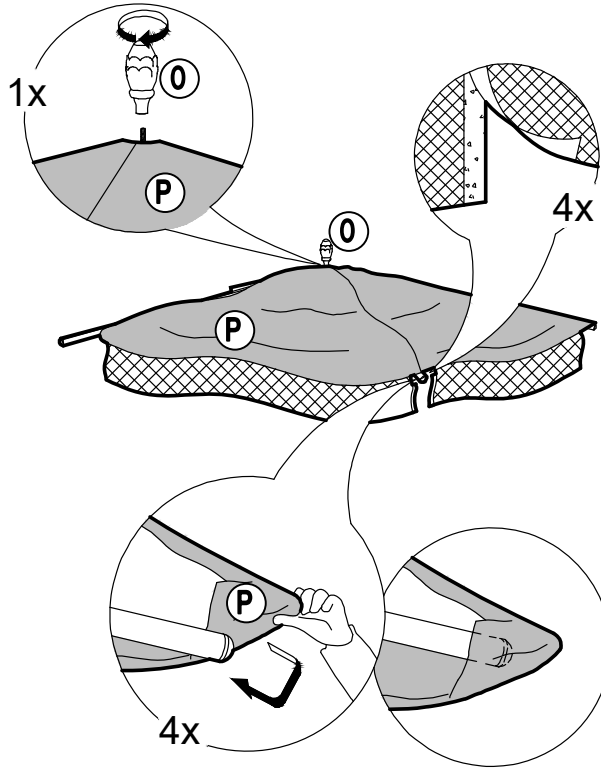

## STEP 12: Attaching the Small Roof to the Big Roof

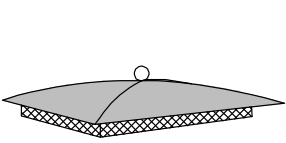
- P12601C01106 (M) 1x 
- 1x 

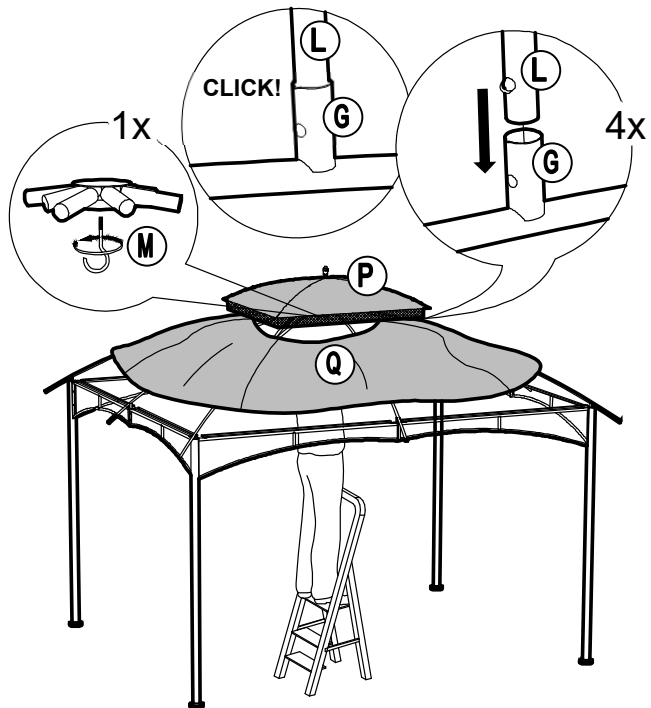

# Assembly (continued)

## STEP 13: Spreading the Big Canopy

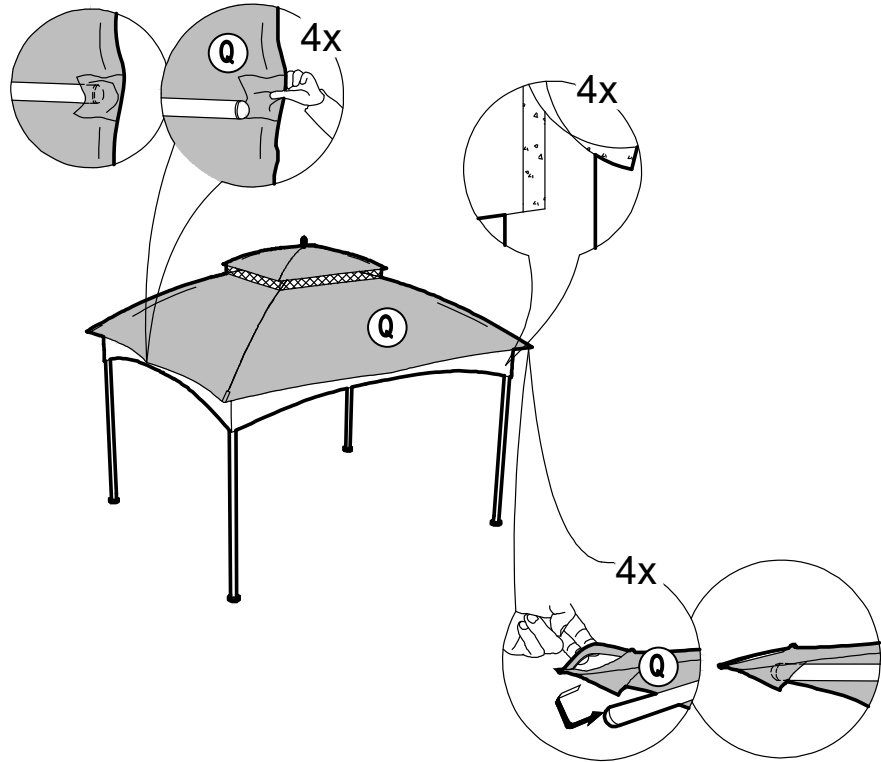

## STEP 14: Hang the Mosquito Netting

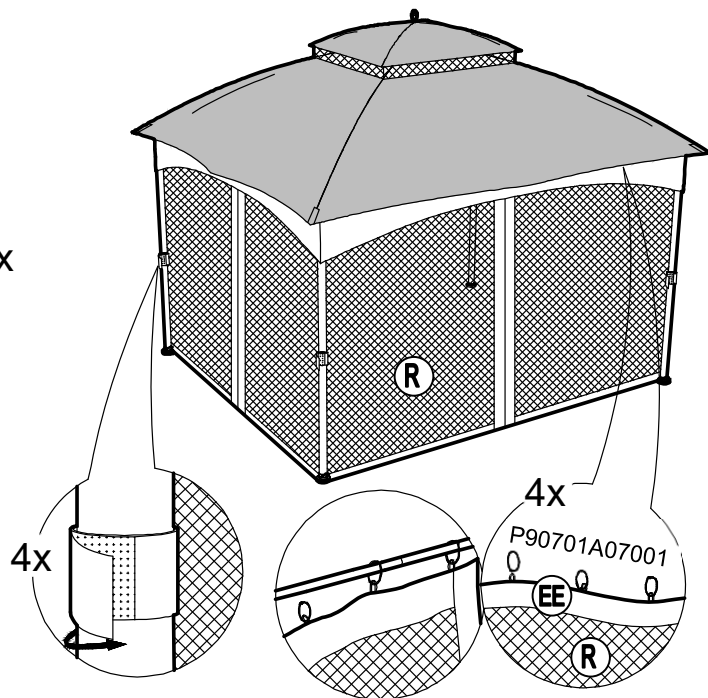
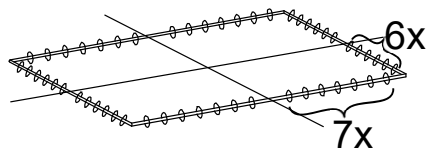
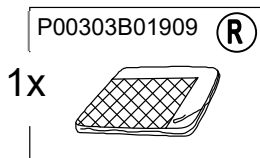

# Assembly (continued)

## STEP 15: Securing the Gazebo

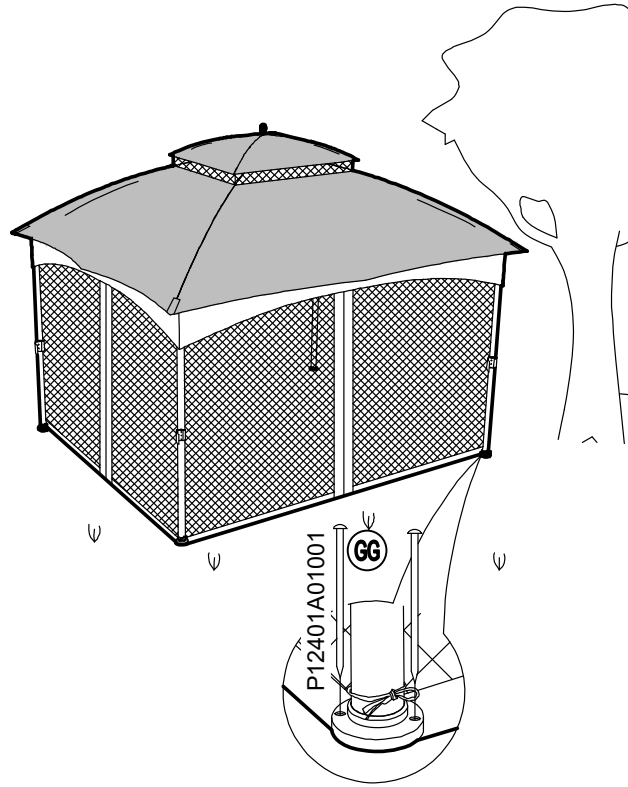

## Care and Cleaning

---

- Before using, clean the gazebo completely with a soft dry towel.
- Do not put your gazebo in wet conditions where there is a risk of rust developing.
- When not in use, store in a cool, dry area.





Questions, problems, missing parts? Before returning to the store,  
call Hampton Bay Customer Service  
8 a.m. - 7 p.m., EST, Monday- Friday, 9 a.m. - 6 p.m., EST, Saturday

**1-855-HD-HAMPTON**

**[WWW.HAMPTONBAY.COM](http://WWW.HAMPTONBAY.COM)**

Retain this manual for future use.