

Water heaters for other than recreational vehicle installation only

WARNING:

If the information in these instructions is not followed exactly, a fire or explosion may result, causing death, personal injury, or property damage.

- Do not store or use gasoline or other flammable vapors and liquids in the vicinity of this or any other appliances. To do so may result in an explosion or fire.
- WHAT TO DO IF YOU SMELL GAS
 - Do not try to light any appliances.
 - Do not touch any electrical switch; do not use any phone in your building.
 - Immediately call your gas supplier from a neighbor's phone. Follow the gas supplier's instructions.
 - If you cannot reach your gas supplier, call the fire department.
 - Do not go back home until authorized by the gas supplier or fire department.
- Installation and service must be performed by a qualified installer, service agency, or the gas supplier.

Do not destroy manual. Please read carefully and keep in a safe place for future reference.

⚠WARNING:

This water heater is not suitable for use in manufactured(mobile) homes.



WATER HEATER USE AND CARE MANUAL

Force Exhaust Outdoor Model NO.:

GA22ONG/LP
JSW44-22ST58

GA26ONG/LP
JSW52-26ST58

GA30ONG/LP
JSW60-30ST58

Note: Please read this manual carefully before use and keep in a safe place for future reference. Illustrations shown in this manual are for reference only.

CONTENTS

Important Safety Information		Installation Instructions	
Safety Precautions	2-8	Standards Compliance	29
Product Information		Choosing a Location	29, 30
Product Information	8	Venting.....	31, 32
Specifications	9, 10	Product Inspection.....	33
General Descriptions	11, 12	Water Heater Installation.....	33-35
Using Your Water Heater		Venting.....	36-38
Setting the Water Temperature	13, 14	Water Supply	37-40
Caring for Your Water Heater		Condensation	41
Water Heater Inspections	15, 16	Gas Supply	42-47
Care and Cleaning	17, 18	Electrical Wiring	47-49
Preventive Maintenance	19, 20	Remote Control Installation	50,51
Draining the Water Heater	21-23	Insulation Blankets	52
Freeze Protection	23	Installation Checklist	53
Vacation and Extended Shutdown	24	Activating the Water Heater	54,55
Troubleshooting Chart	24, 25	Setting the Water Temperature	56,57
Service Error Code Chart	26, 27	Parts Replacement	58,59
If You Need Service			
Call for Assistance	27		

IMPORTANT SAFETY INFORMATION

READ THE SAFETY INFORMATION

Your safety and the safety of others are very important. There are many important safety messages in this manual and on your appliance. Always read and obey all safety messages.



This is the safety alert symbol. Recognize this symbol as an indication of Important Safety Information! This symbol alerts you to potential hazards that can kill or hurt you and others.

All safety messages will follow the safety alert symbol and either the word "DANGER," "WARNING," "CAUTION," or "NOTICE."

These words mean:

⚠️ DANGER: An imminently hazardous situation that will result in death or serious injury.

⚠️ WARNING: A potentially hazardous situation that can result in death or serious injury and/or damage to property.

⚠️ CAUTION: A potentially hazardous situation that may result in minor or moderate injury.

NOTICE: Attention is called to observe a specified procedure or maintain a specific condition.

⚠️ WARNINGS:

- This water heater is not approved for use in manufactured (mobile) homes!
- Improper installation, adjustment, alteration, service, or maintenance can cause death, personal injury or property damage. Follow the instructions in this manual.

READ ALL INSTRUCTIONS BEFORE USING.

Be sure to read and understand the entire Use and Care Manual before attempting to install or operate this water heater. It may save you time and money. Pay particular attention to the Safety Instructions. Failure to follow these warnings could result in death or serious bodily injury. Should you have problems understanding the instructions in this manual, or have any questions, STOP and get help from a qualified service technician or the local gas utility.

⚠️ WARNING:

California Proposition 65

This product contains chemicals known to the state of California to cause cancer, birth defects, or other reproductive harm.

IMPORTANT SAFETY INFORMATION

Water Heater Venting Safety

⚠ DANGER: Failure to install and properly vent the water heater to the outdoors as outlined in the "Venting" section of the Installation Instructions in this manual will result in death from fire, explosion, or asphyxiation from carbon monoxide. NEVER operate this water heater unless it is properly vented and has the air supply piping properly installed and terminated to the outdoors.

⚠ WARNINGS:

- Gasoline and other flammable liquids, materials, and vapors (including paint thinners, solvents, and adhesives) are extremely dangerous. DOT NOT handle, use, or store gasoline or other flammable or combustible materials anywhere in the vicinity of a water heater or any other appliances. Be sure to read and follow the labels on the water heater, as well as the warnings printed in this manual. Failure to do so can result in death, bodily injury, or property damage.
- Combustible construction refers to adjacent walls and ceilings and should not be confused with combustible or flammable products and materials. Combustible materials, such as clothing, cleaning materials, or flammable liquids, should never be stored in the vicinity of this or any gas appliances. Fire or explosion can occur causing death, personal injury, and/or property damage. See page 30 for clearances to combustible materials.
- Follow vent manufacturer's instructions for venting installation, including additional clearances from combustibles, to avoid conditions that can lead to death, personal injury, and/or property damage.
- Moisture in the flue gas will condense as it leaves the vent terminal. In cold weather this condensation can freeze on the exterior wall, under the eaves, and on surrounding objects. Some discoloration to the exterior of the building is to be expected. However, improper location or installation may result in severe damage to the structure or exterior finish of the building.

⚠ DANGER



Flammable Vapors

⚠ Vapors from flammable liquids will explode and catch fire causing death or severe burns.

Do not use or store flammable products such as gasoline, solvents or adhesives in the same room or area near the water heater.

Keep flammable products:

1. far away from heater,
2. in approved containers,
3. tightly closed and
4. out of children's reach.

Water heater has a main burner flame.

The main burner flame:

1. can come on at any time and
2. will ignite flammable vapors.

Vapors:

1. cannot be seen,
2. are heavier than air,
3. go a long way on the floor and
4. can be carried from other rooms to the main burner flame by air currents.

Installation:

Do not install water heater where flammable products will be stored or used unless the main burner flame is at least 18" above the floor. This will reduce but not eliminate the risk of vapors being ignited by the main burner flame.

Read and follow water heater warnings and instructions. If owners manual is missing, contact the retailer or manufacturer.

IMPORTANT SAFETY INFORMATION

Water Supply Safety

⚠️ DANGERS:

- **WATER TEMPERATURE SETTINGS**
 - Safety and energy conservation are factors to be considered when selecting the water temperature setting of a water heater's remote control. Water temperature above 122°F(50°C) can cause death or severe burns from scalding. Be sure to read and follow the warnings outlined on the pictured label.
- There is a hot water scald potential if the water temperature is set too high. Households with small children, disabled, or elderly persons may require a 118°F(48°C) or lower temperature setting to prevent contact with "HOT" water.
- Before manually operating the relief valve, make certain no one will be exposed to the danger of the hot water released by the valve. The water may be hot enough to create a scald hazard. The water should be released into a suitable drain to prevent injury or property damage.
- Failure to perform the recommended Routine Preventive Maintenance can harm the proper operation of this water heater, which can cause carbon monoxide dangers, excessive hot water temperatures, and other potentially hazardous conditions. Refer to "Preventive Maintenance" on page 19 for more information.

⚠️ WARNINGS:

- **IMPORTANT:DO NOT** apply heat to the HOT or COLD water connections. If sweat connections are used, sweat tubing to adapter before fitting adapter to the water connections on heater. Any heat applied to the water supply fittings will permanently damage the internal components of the water heater.
- In case the pipe insulation is not rated for the appropriate weather conditions, install electric heat tracing or equivalent to prevent freezing of the pipes. **DO NOT** insulate or block the drain valve on the hot outlet fitting. If the pipes are allowed to freeze, the water heater and the pipes may malfunction or leak due to freezing water.
- Failure to drain the water heater as described on page 21 can cause serious personal injuries from scalding and/or damage the water heater.

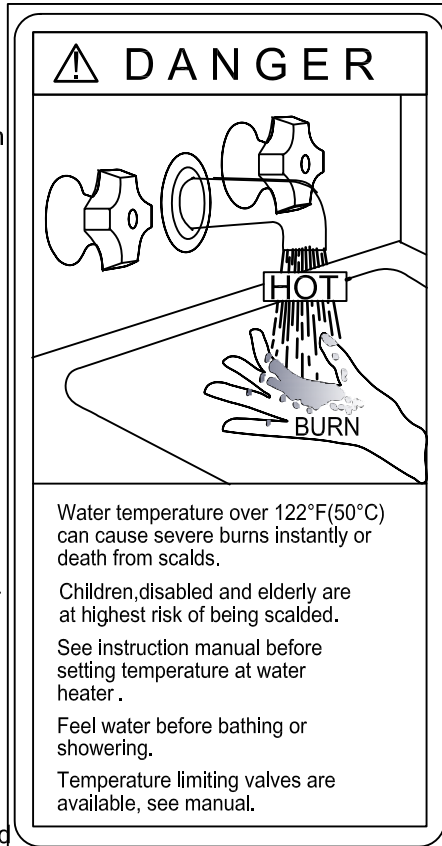

⚠️ CAUTIONS:

- This water heater must only be used with the following water supply system conditions:
 - With clean, potable water free of corrosive chemicals, sand, dirt, or other contaminants.
 - With inlet water temperatures above 32°F(0°C), but not exceeding 118°F(48°C).
 - Do not reverse the hot and cold water connections. The water heater will not operate.
- Even when drained properly, a small amount of water will remain in the water heater. In cold weather conditions, this water can be frozen. If this happens, allow the defrost protection on the heater at least 30 minutes to melt the frozen water or the water heater may not work properly.

Time/Temperature Relationship in Scalds

Water Temperature	Time to Produce a Serious Burn
120°F(49°C)	More than 5 minutes
122°F(50°C)	1 1/2 to 2 minutes
131°F(55°C)	About 30 seconds
135°F(57°C)	About 10 seconds
140°F(60°C)	Less than 5 seconds
145°F(63°C)	Less than 3 seconds
150°F(66°C)	About 1 1/2 seconds
155°F(68°C)	About 1 second

Table courtesy of Shriners Burn Institute

Temperature Conversion Chart °F/°C	
99	37
100	38
102	39
104	40
106	41
108	42
110	43
112	44
114	46
116	47
118	48
122	50
131	55
140	60
°F	°C

IMPORTANT SAFETY INFORMATION

Natural Gas and Liquefied Petroleum Safety

⚠️ DANGERS:

- Never attempt to convert the water heater from natural gas to LP or vice versa. The water heater must only use the fuel type in accordance with listing on data plate—natural gas for natural gas units and LP for LP units. Any other fuel usage will result in death or serious personal injury from fire and/or explosion. This water heater is not certified for any other fuel type.
- Both natural gas and propane (LP) have an odorant added to aid in detecting a gas leak. Some people may not physically be able to smell or recognize this odorant. If you are unsure or unfamiliar with the smell of natural gas or LP, ask the gas supplier. Other conditions, such as "odorant fade" which causes the odorant to diminish in intensity, can also hide or camouflage a gas leak.
- Water heaters using LP gas are different from natural gas models. A natural gas water heater will not function safely on LP and vice versa.
- LP must be used with great caution. It is heavier than air and will collect first in lower areas, making it hard to detect at nose level.
- Before attempting to light the water heater, make sure to look and smell for gas leaks. Use a soapy solution to check all gas fittings and connections. Bubbling at a connection indicates a leak that must be corrected. When smelling to detect a gas leak, be sure to also sniff near the floor.
- Gas detectors are recommended in LP and natural gas applications and their installation should be in accordance with the detector manufacturer's recommendations and/or local laws, rules, regulations, or customs.
- Combustible materials, such as clothing, solvents, cleaning materials, or flammable liquids, must not be placed in the vicinity of the water heater.
- If a gas leak is present or suspected:
 - DO NOT attempt to find the cause yourself.
 - Never use an open flame to test for gas leaks. The gas can ignite resulting in death, personal injury, or property damage.
 - Follow the steps listed under "What to Do If You Smell Gas" found on the front cover of this manual.

⚠️ WARNINGS :

- The installation of gas piping must comply with local utility company requirements and/or in the absence of local codes, use the latest edition of National Fuel Gas Code(NFGC), ANSI Z223.1/NFPA 54.
- If inlet gas pressure is out of allowable range[4.0" wc (1.0kPa)–10.5"w.c(2.6kPa)] for Natural Gas.or[8.0" w.c(2.0kPa)–13.0"w.c(3.2kPa)] for LP gas,a gas pressure regulator must be installed to maintain the allowable inlet gas pressure.
- Should overheating occur or the gas supply fail to shut off, turn off the manual gas control valve to the water heater.

⚠️ CAUTIONS:

- DO NOT attempt repair of electrical wiring, gas piping, remote control, burners, vent connectors, or other safety devices. Refer repairs to qualified service personnel.
- Turn off the manual gas shut-off valve if the water heater has been subjected to overheating, fire, flood, physical damage, or if the gas supply fails to shut off.
- DO NOT turn on the water heater unless the water and gas supplies are completely opened.

IMPORTANT SAFETY INFORMATION

Before operating this water heater, be sure to read and follow the instructions on the label pictured below and all other labels on the water heater as well as the warnings printed in this manual.

Failure to do so can result in unsafe operation of the water heater, resulting in death, personal injury, or property damage. Should you have any problems reading or following the instructions in this manual, STOP and get help from a qualified service technician.

FOR YOUR SAFETY READ BEFORE OPERATING

WARNING: If you do not follow these instructions exactly, a fire or explosion may result causing property damage, personal injury or loss of life

- A. This appliance does not have a pilot light. It is equipped with an ignition device which automatically lights the burner. Do not try to light the burner by hand.
- B. **BEFORE OPERATING** smell all around the appliance area for gas. Be sure to smell next to the floor because some gas is heavier than air and will settle on the floor.
WHAT TO DO IF YOU SMELL GAS
 - Do not try to light any appliance. ● Do not touch any electric switch; do not use any phone in your building. ● Immediately call your gas supplier from a neighbor's phone. Follow the gas supplier's instructions. ● If you cannot reach your gas supplier or fire department, do not return to your home until authorized by the gas supplier or fire department.
- C. Use only your hand to push in or turn the gas control knob. Never use tools. If the knob will not push in or turn by hand, don't try to repair it, call a qualified service technician. Force or attempted repair may result in a fire or explosion.
- D. Do not use this appliance if any part has been under water. Immediately call a qualified service technician to inspect the appliance and to replace any part of the control system and any gas control which has been under water.

OPERATING INSTRUCTIONS

1. STOP! Read the safety information above on this label.
2. Turn off all electric power to the appliance.
3. Do not attempt to light the burner by hand.
4. Turn the Gas Shutoff Valve located on the outside of the unit clockwise ↻ to the "OFF" position.
5. Wait five(5) minutes to clear out any gas. If you then smell gas, STOP! Follow "B" in the safety information above on this label. If you don't smell gas, go to the next step.
6. Turn the Gas Shutoff Valve located on the outside of the unit counterclockwise ↻ to the "ON" position.
7. Turn on all electric power to the appliance.
8. If the appliance will not operate, follow the instructions "To Turn Off Gas To Appliance" and call your service technician or gas supplier.

GAS SHUT OFF
VALVE



OPEN



CLOSE

TO TURN OFF GAS TO APPLIANCE

1. Turn off all electric power to the appliance if service is to be performed.
2. Turn the Gas shutoff Valve located on the outside of the unit clockwise ↻ to the "OFF" position.

IMPORTANT SAFETY INFORMATION

Electrical Safety

⚠️ DANGER: Shock Hazard-Make sure the electrical power to the water heater is off to avoid electric shock that will result in death or serious personal injury.

⚠️ WARNINGS:

- For your safety, the information in this manual must be followed to minimize the risk of fire, explosion, or electric shock that can result in death, personal injury, and/or property damage.
- Field wiring connections and electrical grounding must comply with local codes or, in the absence of local codes, with the latest edition of the National Electrical Code, ANSI/NFPA 70.

⚠️ CAUTIONS:

- Label all wires prior to disconnecting for service. Wiring errors can cause dangerous and improper operation. Verify correct operation after servicing.
- For your safety, burner inspection and cleaning should be performed only by qualified service personnel.
- Make certain the power to the water heater is OFF before removing the unit cover panel. Exposed electrical components and moving parts can cause personal injuries.
- For your safety, DO NOT attempt repair of electrical wiring, gas piping, remote control, burners, vent connectors, or other safety devices. Refer repairs to qualified service personnel.

FOR INSTALLATIONS IN THE STATE OF CALIFORNIA

California law requires that water heaters must be braced, anchored, or strapped to resist falling or horizontal displacement due to earthquake motions. For water heaters up to 52-gallon capacity, a brochure with generic earthquake bracing instructions can be obtained from: Office of the State Architect, 1102 Q Street, Suite 5100, Sacramento, CA 95814, or you may call 916-445-8100 or ask a water heater dealer.

However, applicable local codes shall govern installation. For residential water heaters of a capacity greater than 52 gallons or tankless style, consult the local building jurisdiction code for acceptable bracing procedures.

IMPORTANT SAFETY INFORMATION

Safety

Product Information

General Installation and Maintenance Safety

⚠️ WARNINGS:

- This water heater must be installed in accordance with these instructions, local codes, utility company requirements and/or in the absence of local codes, use the latest edition of the American National Standard/National Fuel Gas Code (NFGC), ANSI Z223.1 and National Fire Protection Association, NFPA 54, and the latest edition of the National Electrical Code, ANSI/NFPA 70.
- For your safety, DO NOT attempt to disassemble this water heater for any reason. Improper adjustments, alterations, service, or maintenance can cause death, personal injury, or property damage.

SAFETY PRECAUTIONS:

- Read this manual entirely before installing and/or operating the water heater.
- Use this water heater only for its intended purpose as described in this Use and Care Manual.
- Have the installer show you the location of the gas shut-off valve and how to shut it off if necessary. Turn off the manual shut-off valve if the water heater has been subjected to overheating, fire, flood, physical damage, or if the gas supply fails to shut off.
- Be sure your water heater is properly installed in accordance with local codes and the provided installation instructions.
- DO NOT attempt to repair or replace any part of your water heater unless it is specifically recommended in this manual. All other servicing should be referred to a qualified service technician.

SAVE THESE INSTRUCTIONS

PRODUCT INFORMATION

For Your Records

Write down and save the following product information along with the original sales slip and/or cancelled check. The model and serial numbers can be found on the top label on the right side of the water heater

MODEL NUMBER: _____

SERIAL NUMBER: _____

DATE OF INSTALLATION: _____

INSTALLING COMPANY/PHONE NUMBER

PLUMBING CONTRACTOR/PHONE NUMBER

See page 26 for additional service information.

Read This Manual

Inside you will find many helpful hints on how to use and maintain your water heater properly. A little preventive care on your part can save you time and money over the life of your water heater.

You'll find many answers to common problems in the Troubleshooting Chart on pages 23 and 24 . Always refer to this chart before calling for service. Referring to this chart before calling may answer your question(s) and eliminate the need for service.

Pre-Operating Checklist

- Is the main gas valve to the water heater turned on?
- Is the fuse in place or is the breaker turned on?
- Does the water heater's electronic ignition light?
- Is the water temperature set to a safe temperature?
- Is the water heater connected to a floor drain?
- Is the water heater properly vented to the outside?
- Is the water heater installed in a safe location away from flammable materials and/or freezing conditions?

PRODUCT INFORMATION

Specifications – Outdoor 199,000 Btu/hr Models (GA30ONG/LP)

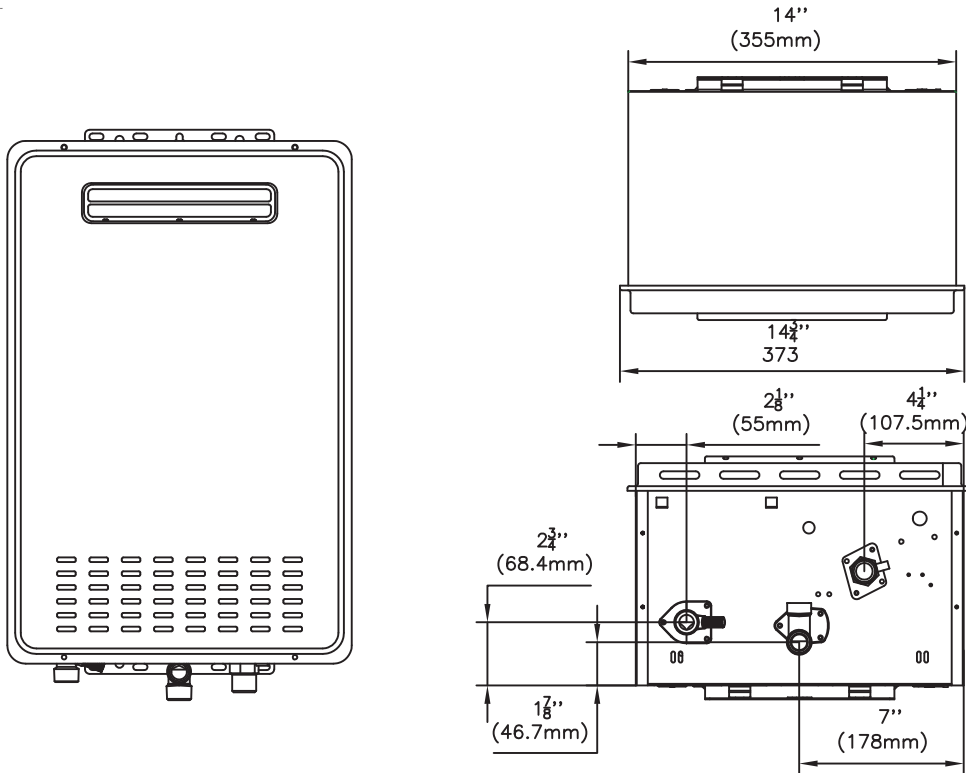

PRODUCT INFORMATION

Specifications – Outdoor 150,000Btu/hr Models (GA22ONG/LP)
Specifications – Outdoor 180,000 Btu/hr Models (GA26ONG/LP)

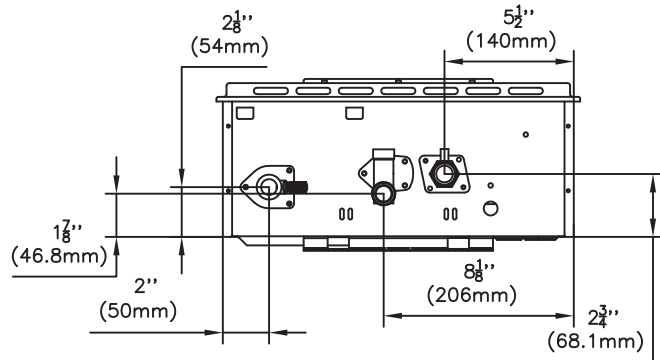
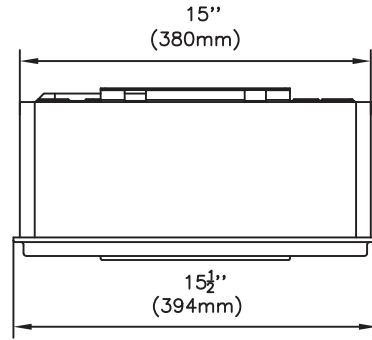
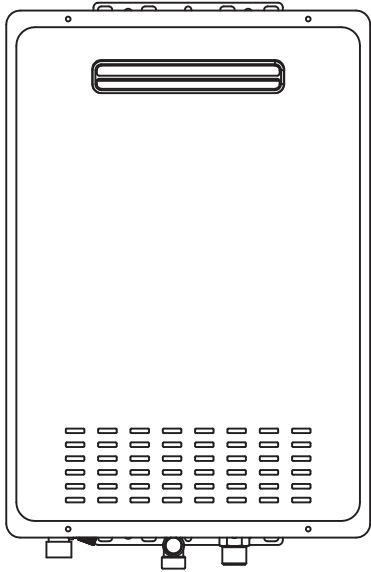

PRODUCT INFORMATION

Specifications

The following product information can be found from the rating label on this water heater.

- A. Model Number
- B. Serial Number
- C. Data Bar Code
- D. Heater Type
- E. Installation Type
- F. Type of Gas
- G. Max.Inlet Gas Pressure
- H. Min.Inlet Gas Pressure
- J. Recovery Rating
- K. Max. BTU Input Rating
- L. Min.BTU Input Rating
- M. Manifold Gas Pressure
- N. Certification Stamp
- P. Alternate Approval Stamp
- Q. Clearances

English Rating Label

MODEL NO. A
SERIAL NUMBER B
AUTOMATIC INDEPENDENT WATER HEATER C
ANSI Z21.10/CSA 4.8-09B FOR INSTALLATION ONLY P

TYPE OF GAS: F GAS
MAX. INLET GAS PRESSURE: G "in. H₂O
MIN. INLET GAS PRESSURE: H "in. H₂O
RECOVERY RATING: J GALLONS/HR
MAX. WORKING PRESSURE: 150 psi
ELECTRICAL RATING: 120V 60HZ LESS THAN 2 AMPS

MAX. INPUT: K BTU/HR
MIN. INPUT: L BTU/HR
MANIFOLD PRESSURE: M "in. H₂O (FOR MAX. INPUT) N

This appliance must be installed in accordance with local codes or, in the absence of local codes, the National Fuel Gas Code, ANSI Z223.1/NFPA 54 or the CSA B140.1, Natural Gas and Propane Installation Code.

"Suitable for water (potable) heating and space heating." The water heater shall not be connected to any heating system or component previously used with a nonpotable water heating appliance. A pressure relief valve listed as complying with the Standard for Relief Valves and Automatic Gas Shut-off Devices for Hot Water Supply Systems, ANSI Z21.22 shall be installed at the hot water outlet connection of the water heater at the time of installation of the heater. Local codes shall govern the installation of relief devices. For safe operation of the water heater, the relief valve(s) must not be removed or plugged. The valve shall be placed between the relief valve and the water heater. The relief from the discharge of the pressure relief valve shall be directed to a suitable place where it will cause no damage. Also there shall be no other reducing coupling or other restrictions installed on the discharge line to restrict flow. See Installation Manual for details.

PRESSURE RELIEF VALVE: For installation and maintenance of relief valve discharge line and other safety precautions. Turn off the electrical power and gas shutoff valve. Lift and release lever on the relief valve and check the manual operation of relief valve at least once a year. Make certain the discharged water is directed to a suitable drain. Avoid contact with hot water and prevent water damage.

MINIMUM CLEARANCE FROM COMBUSTIBLE OR NONCOMBUSTIBLE CONSTRUCTION: 1" SEE CLEARANCE FROM PLUMBING INTO WALLS, 6" SEE CLEARANCE FROM LIGHTING BRACKET TO WALLS, 12" FROM TOP OF HEATER TO CEILING, 12" FROM BOTTOM OF HEATER TO FLOOR, 12" FRONT CLEARANCE FROM FRONT OF HEATER TO CLOSED DOOR. *NOTE: 24" MINIMUM RECOMMENDED FRONT CLEARANCE FOR SERVICE AND MAINTENANCE OF THE FRONT COVER.

FOR YOUR SAFETY: DO NOT STORE OR USE GASOLINE OR OTHER FLAMMABLE VAPORS AND LIQUIDS IN THE VICINITY OF THIS OR ANY OTHER APPLIANCE. Q

Product Information

English/French Rating Label

MODEL NO. A
NUMÉRO DE MODÈLE B
AUTOMATIC INDEPENDENT WATER HEATER C
CHaudière AU INDEPENDANT AUTOMATIQUE P

TYPE OF GAS: F GAS
MAXIMUM INLET GAS PRESSURE: G "in. H₂O
MINIMUM INLET GAS PRESSURE: H "in. H₂O
RECOVERY RATING: J GALLONS/HR
MAX. WORKING PRESSURE: 150 psi
ELECTRICAL RATING: 120V 60HZ LESS THAN 2 AMPS

MAXIMUM INPUT: K BTU/HR
MINIMUM INPUT: L BTU/HR
MANIFOLD PRESSURE: M "in. H₂O (FOR MAXIMUM INPUT) N

This appliance must be installed in accordance with local codes or, in the absence of local codes, the National Fuel Gas Code, ANSI Z223.1/NFPA 54 or the CSA B140.1, Natural Gas and Propane Installation Code.

MINIMUM CLEARANCE FROM COMBUSTIBLE OR NONCOMBUSTIBLE CONSTRUCTION: 1" SEE CLEARANCE FROM PLUMBING INTO WALLS, 6" SEE CLEARANCE FROM LIGHTING BRACKET TO WALLS, 12" FROM TOP OF HEATER TO CEILING, 12" FROM BOTTOM OF HEATER TO FLOOR, 12" FRONT CLEARANCE FROM FRONT OF HEATER TO CLOSED DOOR. *NOTE: 24" MINIMUM RECOMMENDED FRONT CLEARANCE FOR SERVICE AND MAINTENANCE OF THE FRONT COVER.

FOR YOUR SAFETY: DO NOT STORE OR USE GASOLINE OR OTHER FLAMMABLE VAPORS AND LIQUIDS IN THE VICINITY OF THIS OR ANY OTHER APPLIANCE. Q

FOR YOUR SAFETY: DO NOT STORE OR USE GASOLINE OR OTHER FLAMMABLE VAPORS AND LIQUIDS IN THE VICINITY OF THIS OR ANY OTHER APPLIANCE. Q

PRODUCT INFORMATION

Typical Outdoor Water Heater (No Venting Required)

This water heater is for OUTDOOR installation only.

⚠ DANGER: DO NOT install this water heater indoor or in a confined space. It is designed for outdoor installation only. Any other type of installation will result in death or serious personal injury.

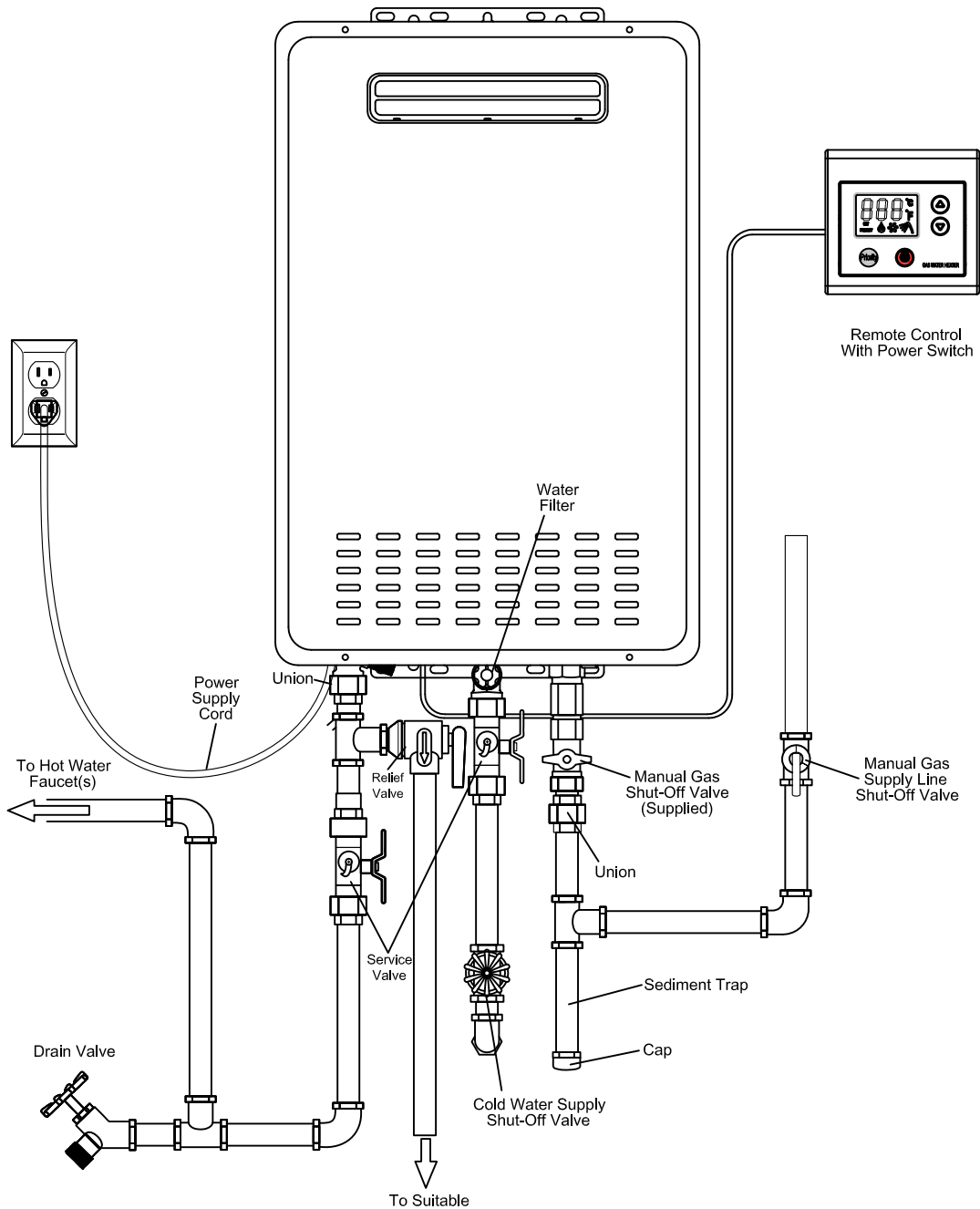

*Note: A flexible drain tube can be used

USING YOUR WATER HEATER



Safety Precautions

⚠️ WARNING: Flammable vapors can be drawn by air currents from surrounding areas to the water heater. Vapors can ignite causing death, personal injury, or product damage.

- DO NOT store or use flammable or combustible materials (gasoline, paint thinner, adhesives, solvents, newspapers, rags, mops, etc.) in the vicinity of the water heater or any other gas appliance. If they must be used, open doors and windows for ventilation, and shut off all gas-burning appliances, including their pilot lights.
- DO turn off manual gas shut-off valve if water heater has been subjected to overheating fire, flood, physical damage, or if the gas supply fails to shut off.

- DO NOT turn on water heater unless water and gas supplies are completely opened.
- DO NOT turn on water heater if cold water supply shut-off valve is closed.
- If there is any difficulty in understanding or following the operating and care instructions in this manual, it is recommended that you contact a qualified service technician to perform the work.
- The appliance and its gas connection must be leak tested before placing the appliance in operation.



Setting the Water Temperature

⚠️ DANGER: Water temperatures above 122°F (50°C) will result in death and/or severe burns from scalding.

Safety and energy conservation are factors to be considered when selecting the water temperature setting. The temperature of the water in the water heater can be regulated by setting the temperature on the front of the remote control. Be sure to read and follow the warnings outlined on the pictured label.

The recommended setting for the water temperature is 99°F (37°C). The remote control has been preset and shipped at the recommended temperature setting.

Safety factors should be considered whenever altering the water temperature setting. The chart below may be used as a guide in determining the proper water temperature for your home.

Time/Temperature Relationship in Scalds

Water Temperature	Time to Produce a Serious Burn
120°F (49°C)	More than 5 minutes
122°F (50°C)	1 1/2 to 2 to minutes
131°F (55°C)	About 30 seconds
135°F (57°C)	About 10 seconds
140°F (60°C)	Less than 5 seconds
145°F (63°C)	Less than 3 seconds
150°F (66°C)	About 1 1/2 seconds
155°F (68°C)	About 1 second

Table courtesy of Shriners Burn Institute

⚠️ DANGER

Water temperature over 122°F (50°C) can cause severe burns instantly or death from scalds.

Children, disabled and elderly are at highest risk of being scalded.

See instruction manual before setting temperature at water heater.

Feel water before bathing or showering.

Temperature limiting valves are available. See manual.

Use Instructions

USING YOUR WATER HEATER



Setting the Water Temperature (cont.)

Maximum water temperature occurs while the water heater burner is ON. To determine the water temperature:

Turn on the hot water faucet and place a thermometer in the water stream.

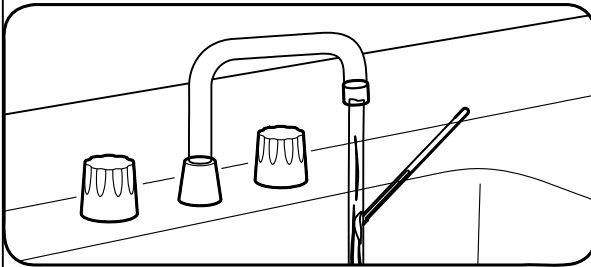

NOTICE: Water temperature at the faucet may vary depending on the season and the length of pipe from the water heater.

The remote control temperature range is between 99°F(37°C) and 140°F(60°C). To adjust the temperature to a desired setting, press the UP or DOWN adjustment button on the face of the remote control. The new temperature set point will show on the LED display.

NOTICES:

- The water heater may not operate with a small water flow. Increase the water flow and recheck. If it still does not operate with the hot water faucet completely open, increase the temperature setting on the remote control.
- Adjustment procedures to provide a low-flow rate setting equal to or greater than the manufacturer's specified minimum input rating as shown on the rating plate (see Clause 4.16, Adjustment of minimum input rating).

Water Heater Facts

⚠ DANGER: Water temperatures above 122°F (50°C) will result in death and/or severe burns from scalding.

- The hottest temperature water will be at the faucet closest to the water heater.
- Always remember to test the water temperature with your hand before use.
- Always supervise young children or others who are incapacitated.
- The water heater is equipped with a device that will shut off the gas supply to the burner if the water heater exceeds normal operating temperatures.
- Any water heater that has been subjected to fire, flood, physical damage, or been under water should be turned off at the manual gas shut-off valve and not used until it has been checked by qualified service personnel.

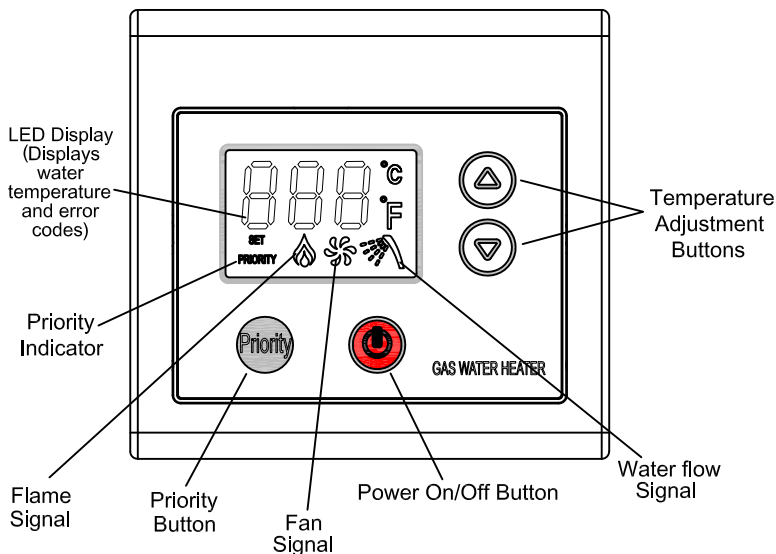

CARING FOR YOUR WATER HEATER



Water Heater Inspections

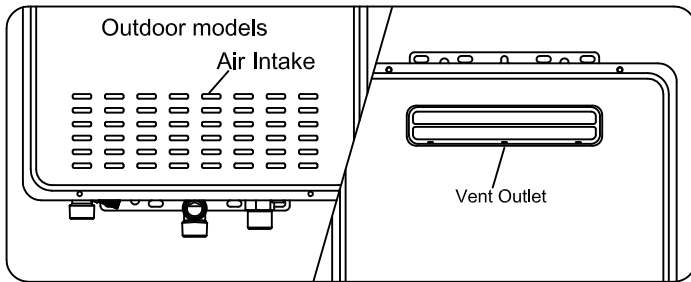

For outdoor models, check the air intake and vent outlet for blockage and/or debris.

⚠ DANGER: Shock Hazard-Make sure the electrical power to the water heater is OFF before removing protective cover. Electric shock will cause death or serious personal injury.

CARING FOR YOUR WATER HEATER



Water Heater Inspections (cont.)

Burner

It is recommended the burner be annually inspected by a qualified service technician.

⚠ DANGER: Shock Hazard-Removing the front cover panel exposes you to live electricity. Electric shock will cause death or serious personal injury.

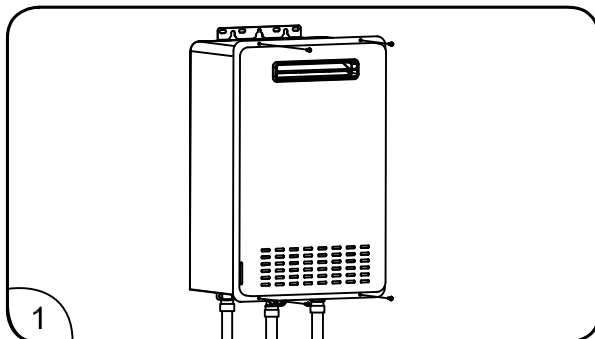

Remove 6 screws and the unit cover panel.

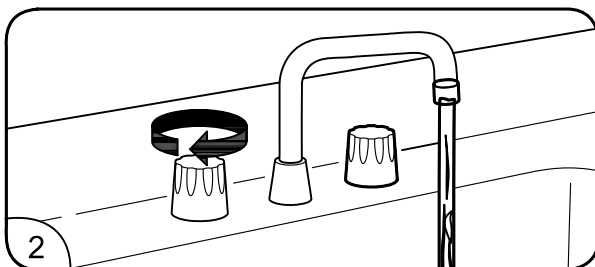

Turn on a hot water faucet.

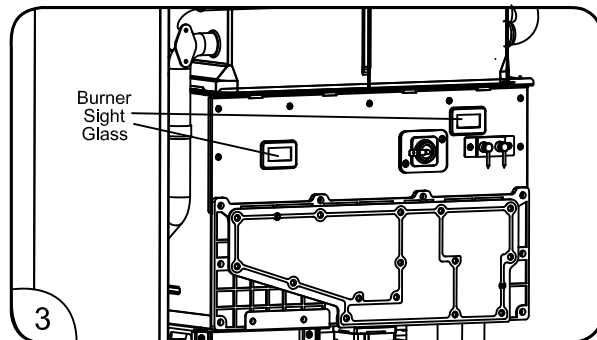

While the water heater is operating, inspect the main burner flames through the burner sight glass. The flames should be blue when the main burner is firing.

NOTICE: If the flames are not blue or you observe unusual burner operation, shut off the water heater and contact a qualified service technician.

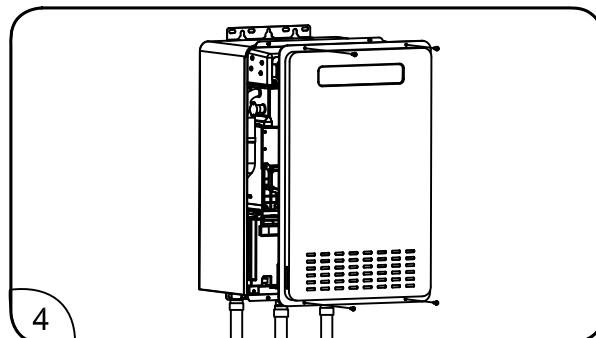

Turn off the hot water faucet and reinstall the unit cover panel.

CARING FOR YOUR WATER HEATER



Care and Cleaning

⚠️ DANGER: Shock Hazard-Make certain power to the water heater is OFF before removing protective cover for any reason. Electric shock will cause death or serious personal injury.

⚠️ WARNING: Combustible materials, such as clothing, cleaning materials, or flammable liquids, must not be placed against or next to the water heater. Fire or explosion can occur causing death, personal injury, and/or product damage.

All care and cleaning to and around the water heater should only be performed with the water heater turned off and the electrical power supply disconnected.

NOTICE: The air intake requires a minimum of 12 in.(30 cm) of clearance between the air intake opening and any obstruction.

Clean the water filter monthly, as described below.

Water Filter Cleaning

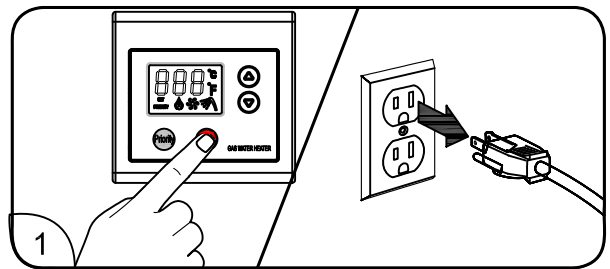

1 Turn off the water heater and disconnect the electrical power supply.

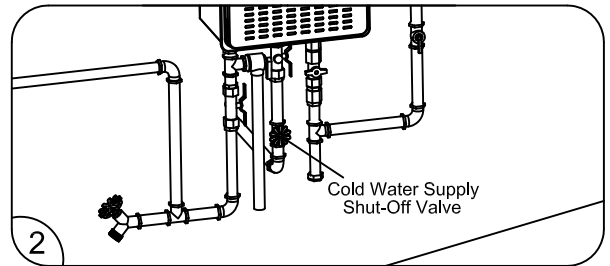

2 Turn off the water supply to the water heater.

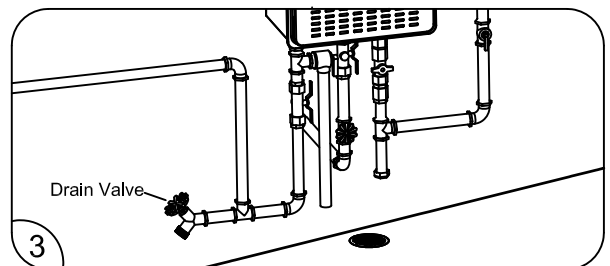

3 Drain the water heater. See page 21.

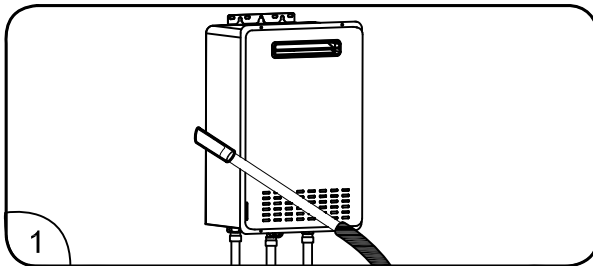

1 Vacuum around the water heater to remove any dust, dirt, and/or lint buildup.

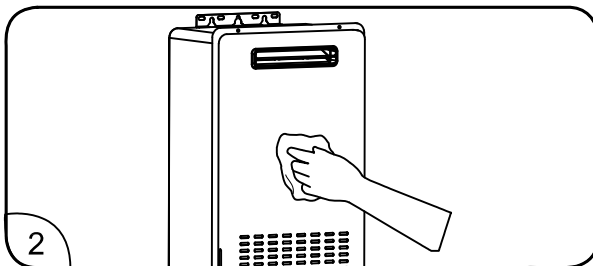

2 Clean the water heater and the remote control with a damp soft cloth and mild detergent. Gently wipe and completely dry all surfaces.

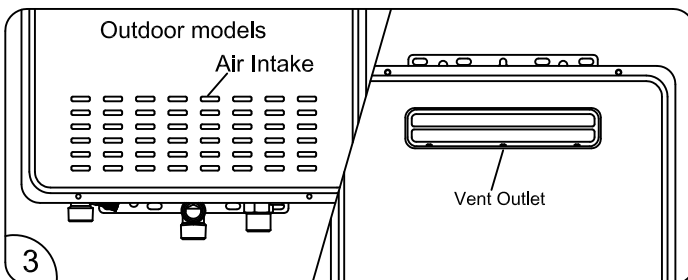

3 Check the air intake and vent outlet for blockage and/or debris.

CARING FOR YOUR WATER HEATER



Care and Cleaning (cont.)

CAUTION: DO NOT tap or force the filter during removal. This can deform and/or damage the filter.

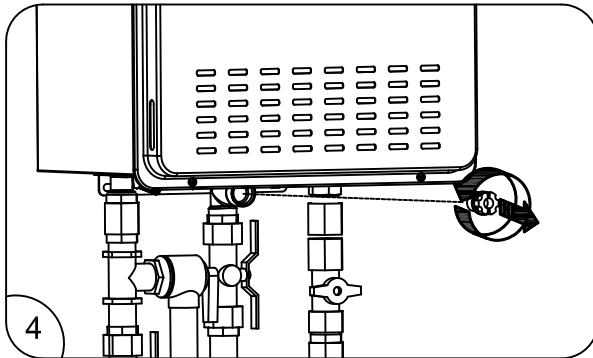

Unscrew the water filter from the base of the cold water inlet line and carefully slide it out of the line.

CAUTION: DO NOT overtighten the water filter. Overtightening can deform and/or damage the filter.

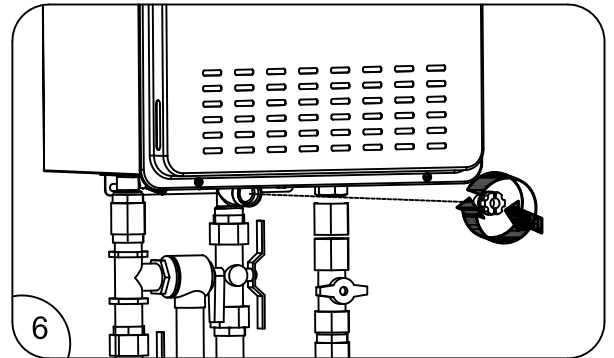

Replace the filter in the cold water inlet line and tighten until it is snug.

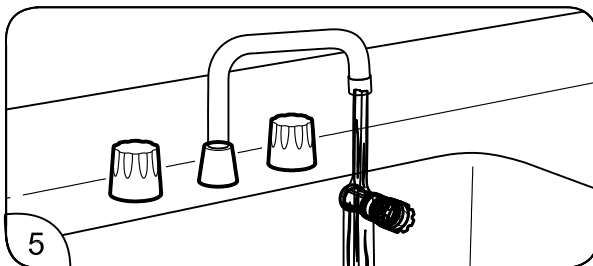

Clean the water filter under running water. To remove severe sediment and dirt, use a soft brush.

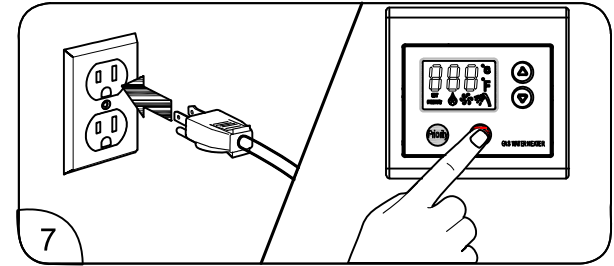

Turn on the water supply, reconnect the electrical supply, and turn on the water heater.

CARING FOR YOUR WATER HEATER

Preventive Maintenance

WARNING:

Failure to perform routine preventive maintenance can cause carbon monoxide dangers, excessive water temperatures, and other potentially hazardous conditions resulting in death, personal injury, and/or product damage.

Properly maintaining your water heater will ensure dependable, trouble-free service.

User Preventive Maintenance

Establish and follow a routine preventive maintenance with the water cut off and the electrical power supply disconnected.

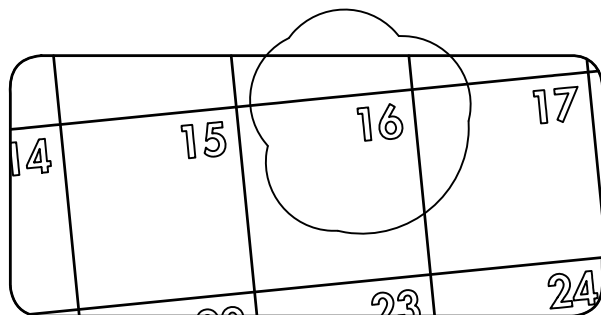

- Check and the water filter monthly. See "Water Filter Cleaning" on page 17.

 **WARNING:** Hot water is released during manual operation of the relief valve. Make sure all people and animals are clear from the area before performing this check to prevent death, personal injury, and/or property damage from hot drain water.

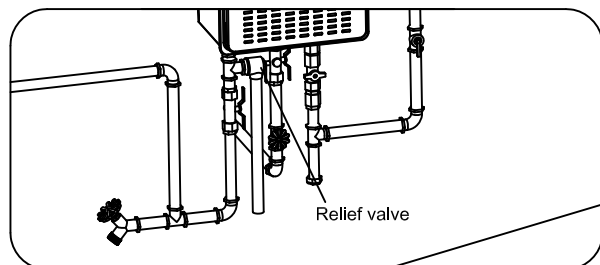

- Check the operation of the pressure relief valve annually. Lifting the lever handle on the pressure-relief valve opens the valve to flush hot water through the discharge line to the drain. After several gallons have drained, release the lever handle to close the valve and stop draining.

 **WARNING:** If the pressure relief valve on the hot water heater discharges periodically, this may indicate a problem in the water system. Contact the water supplier or a plumbing contractor to correct the problem. **DO NOT** plug the relief valve outlet.

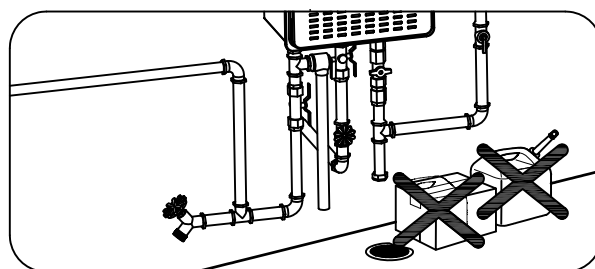

- Inspect and keep the area around the water heater clear and free of flammable materials, such as gasoline and other flammable vapors and liquids.
- Visually inspect the water heater for damage and/or denting. If present, contact a service professional to verify proper operation.
- Check for abnormal sound during normal operation (e.g., hissing, or banging noises). Contact a qualified professional when abnormal sounds are noted.
- Check all gas and water pipes for leaks.

NOTICES:

- **DO NOT** operate the water heater if you feel something is wrong with the unit.
- **DO NOT** allow children to operate or handle the unit.
- After inspections, maintenance, and/or cleaning, ensure proper operation by turning on hot water faucet.

Professional Preventive Maintenance

It is recommended that a periodic inspection of the unit be performed to ensure proper operation by turning on hot water faucet.

CARING FOR YOUR WATER HEATER



Preventive Maintenance

NOTICES: Maintenance instructions (including recommended frequency guidelines) suggesting:

- information covering the cleaning of the burner(s).
- periodic visual check of pilot and burner flames by comparison with pictorial sketches or drawings.
- keeping appliance area clear and free from combustible materials , gasoline , and other flammable vapors and liquids .
- not obstructing the flow of combustion and ventilation air.
- if the water heater manufacturer's instructions recommend manual operation of the relief valve , the instructions shall also provide information to the user regarding precautions that must be taken prior to operating the relief valve to avoid contact with hot water coming out of the relief valve and to prevent water damage .
- if a relief valve discharges periodically , this may be due to thermal expansion in a closed water supply system . Contact the water supplier or local plumbing inspector on how to correct this situation . Do not plug the relief valve .

WARNING: For appliances for other than recreational vehicle installation only , the following statement : " Do not use this appliance if any part has been under water . Immediately call a qualified service technician to inspect the appliance and to replace any part of the control system and any gas control which has been under water . "

CARING FOR YOUR WATER HEATER

Draining the Water Heater

⚠️ WARNING: Failure to follow these draining instructions can cause serious personal injury from scalding and/or product damage.

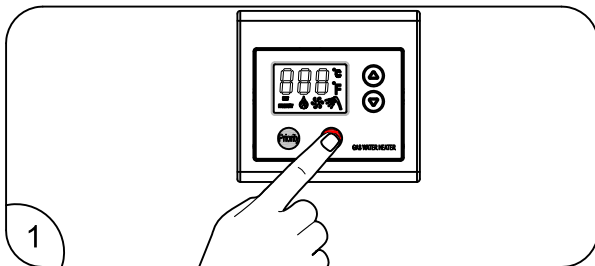

1 Turn off the water heater by pressing the POWER ON/OFF button on the remote control.

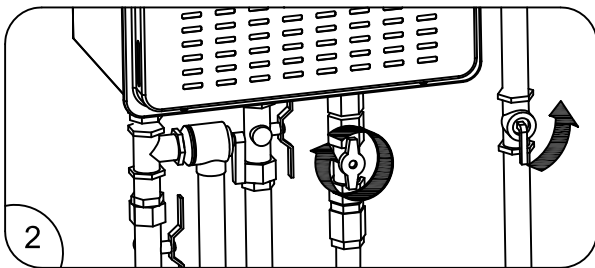

2 Close the gas shut-off valve(s).

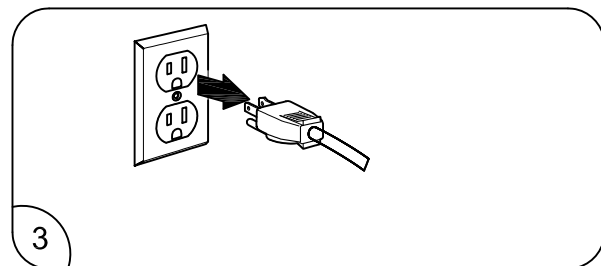

3 At least 10 seconds after Step 1, unplug the water heater .

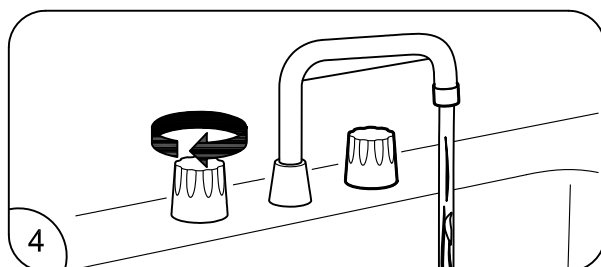

4 Open all hot water faucets. Run the water until it is COLD; then shut off the faucet.

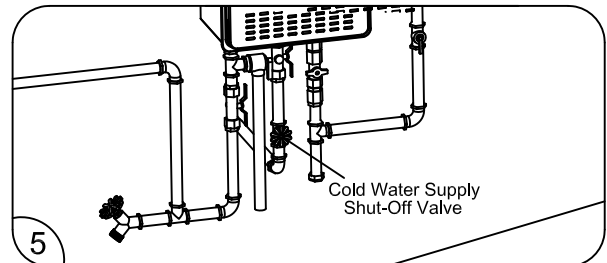

5 Close the water shut-off valve.

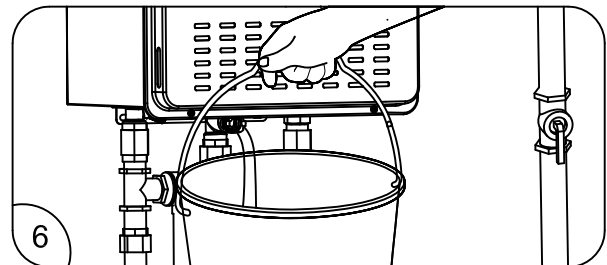

6 Using a suitable container to catch the water, remove the water filter from the base of the cold water inlet line.

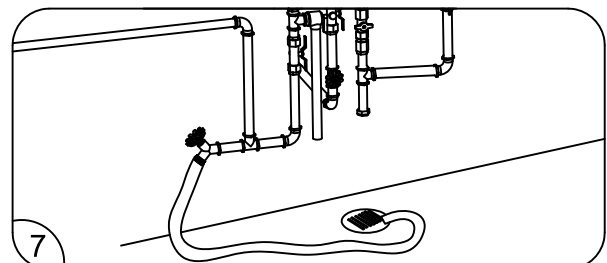

7 Connect a garden hose to the drain valve in the hot water outlet line and place the other end in a suitable drain. Open the drain valve until all the water has been drained from the water heater. Leave water heater as is until placed back in service.

CARING FOR YOUR WATER HEATER

⚠ CAUTION: Even when drained properly, a small amount of water will remain in the water heater. In cold weather conditions, this water can be frozen. If this happens, allow the defrost protection on the water heater at least 30 minutes to melt the frozen water. The water heater will not work properly until this water is thawed.

To put the water heater back in service:

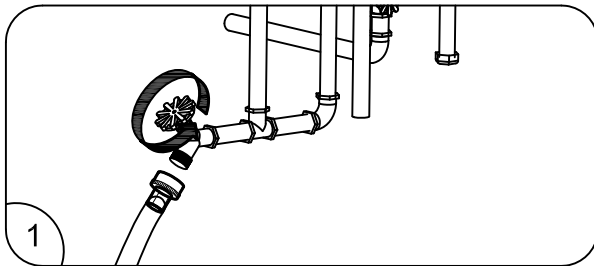

Disconnect drain hose. Make sure the drain valve is closed.

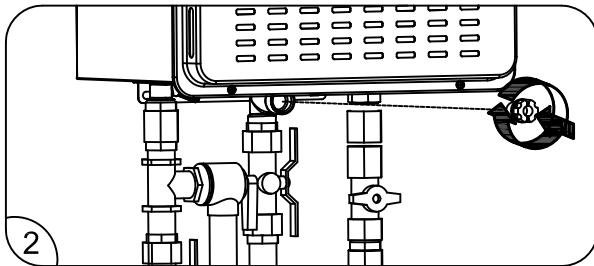

Reinstall the water filter in the base of the cold water inlet line.

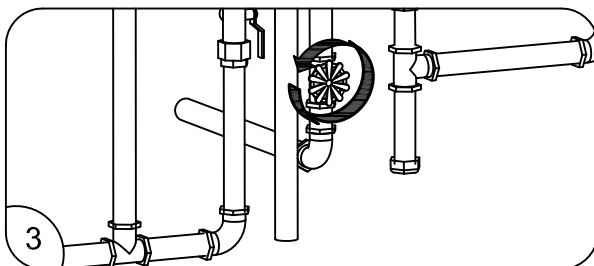

Open the water shut-off valve.

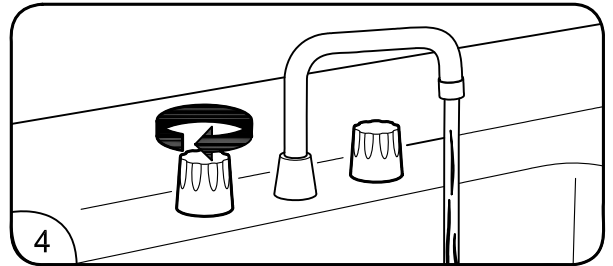

Open all hot water faucets and let run until all air has been purged from the lines.

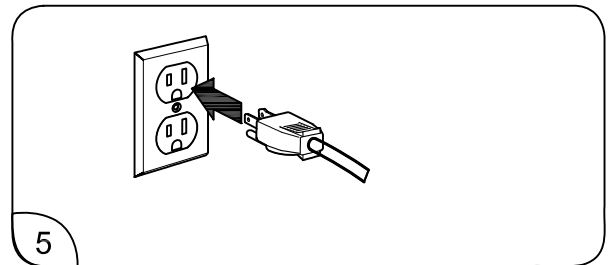

Plug in the power cord .

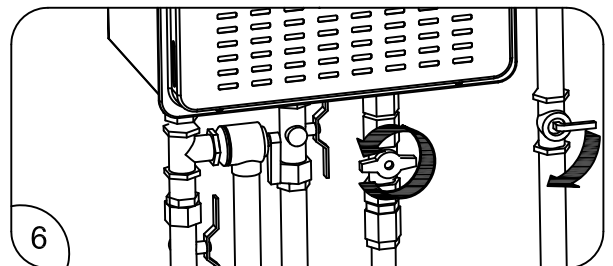

Open the gas shut-off valve(s).

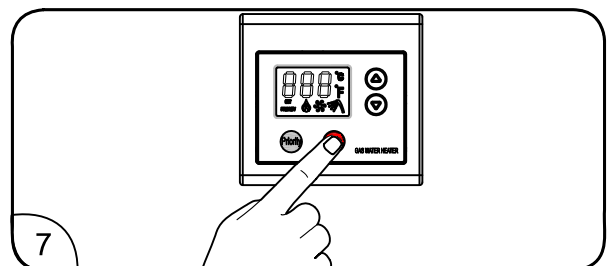

Press the POWER ON/OFF button on the remote control to restart the unit.

CARING FOR YOUR WATER HEATER

Draining the Water Heater (cont.)

Standard Drain Method

Service isolator valve kits may be purchased from the manufacturer, distributor, or place of purchase. The kits include two full-port isolation valves to be used in the inlet and outlet water lines. These kits provide a means for full diagnostic testing and ease of system flushing.

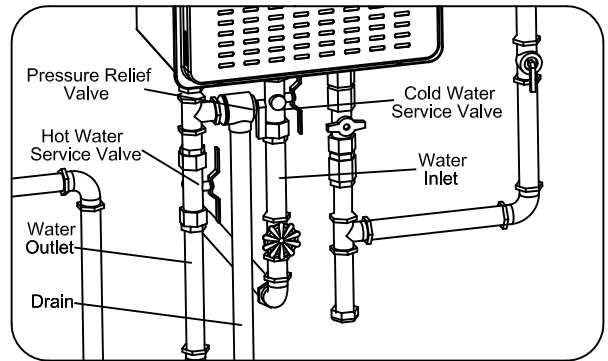

Freeze Protection

⚠️ WARNING: Failure to drain the water heater can cause serious personal injury from scalding and/or product damage.

Whenever the water heater may be exposed to freezing conditions, make sure to drain the water completely from the unit. See page 21 .

Freezing conditions come from the ventilation system on direct-vent models and from exposure to cold air on outdoor models.

All of these water heaters are equipped with a freeze protection electric heater. This heater prevents freezing inside the water heater down to an ambient temperature of approximately -30°F(-34°C). These temperatures are all based on temperatures without wind.

The heater only protects the internal components of the water heater.

NOTICE: Unplugging or disconnecting the power supply to the water heater will also disconnect the power to the heater.

External piping and valves require additional freeze protection. One method is to wrap insulation around the piping and valves.

Another method is to turn on a hot water faucet and leave a small amount of water running at a faucet. This will protect the water heater, piping, and valves from freezing.

Running Water Freeze Protection

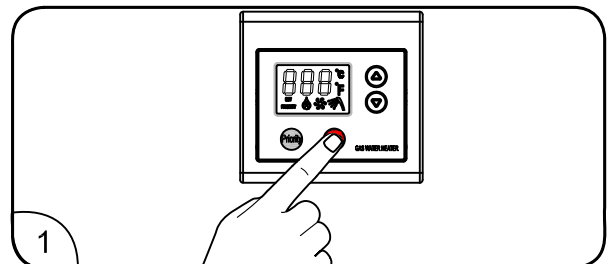

Turn off the water heater by pressing the POWER ON/OFF button on the remote control.

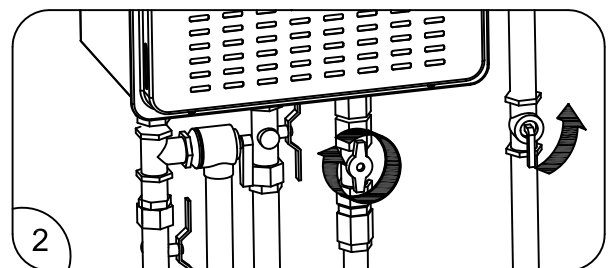

Close the gas shut-off valve(s).

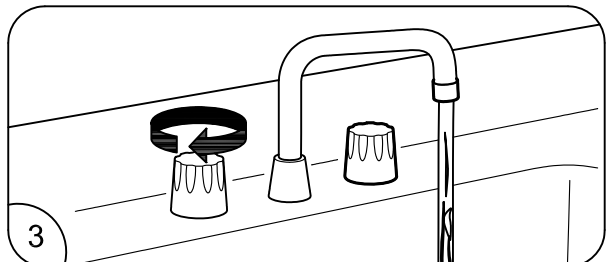

Open a hot water faucet slightly until the water stream is approximately 1/8 IN.(0.3 CM). Be sure to check the flow periodically.

CARING FOR YOUR WATER HEATER



Vacation and Extended Shutdown

⚠️ WARNING: Failure to drain the water heater can cause serious personal injury from scalding and/or product damage.

If the water heater is to remain idle for an extended period of time, the power and water to the heater should be turned off.

The water heater and piping should be drained if they might be subjected to freezing temperatures. See "Freeze Protection" section on page 23 .

After an extended shutdown, the water heater's operation and controls should be checked by a qualified service technician.



Troubleshooting Chart

The information in the following troubleshooting chart may help you diagnose and/or fix a problem you may be experiencing. Please review this chart before calling for service assistance.

⚠️ DANGER: Shock Hazard-Make certain power to the water heater is OFF before removing protective cover for any reason. Electric shock will cause death or serious personal injury.

⚠️ WARNING: For Your Safety DO NOT attempt repair of electrical wiring, gas piping remote control, burners, vent connectors, or other safety devices. Refer repairs to a qualified service technician.

Problem	Possible Cause	Solution
	1. Unit is not ON	1. Turn on the unit by pressing the POWER ON/OFF button.
	2. Water shut-off valve is not completely opened.	2. Check shut-off valve and open completely.
	3. Hot water faucet is not completely opened. (The main burner goes off when incoming water volume is inadequate.)	3. Open hot water faucet completely.
	4. Water piping is frozen.	4. Allow piping to thaw.
	5. Electrical power is disconnected or water supply is shut off.	5a. Plug in the power cord or reconnect the power supply at the circuit breaker box. 5b. Completely open the water supply valve. (Inadequate water volume will cause the main burner to turn off.)
	6. The temperature may be set too low.	6. Increase the temperature setting.
	7. Mixing valve malfunctions (if applicable).	7. Check and replace the mixing valve.
	8. Error code displayed on the remote control.	8. See "Service Error Code Chart" on page 26. If required, contact a qualified service technician.
	9. Not enough water demand.	9. Increase the hot water flow at the faucet.
	10. Water filter is clogged or dirty.	10. Clean the water filter. (See page 17.)
	11. Fixture aerator is clogged or dirty.	11. Clean the aerator.
	12. Scale buildup in the heat exchanger.	12. Check for error code. If required, contact a qualified service technician.
	13. Hot and cold water lines reversed.	13. Reverse the water lines.

CARING FOR YOUR WATER HEATER



Troubleshooting Chart (cont.)

Problem	Possible Cause	Solution
<p>Water not hot enough.</p>	1. The temperature may be set too low.	1. Increase the temperature setting at the remote control.
	2. The gas valve is not completely opened.	2. Check and completely open the gas valve.
	3. Gas supply pressure is low.	3. Contact your gas utility company or gas contractor to verify the gas meter and gas piping size.
	4. Bleed over in one of the hot water fixtures.	4. Contact a dealer or a qualified service technician.
<p>Water too hot.</p>	1. Temperature is set too high.	1. Decrease the temperature setting at the remote control.
	2. Water shut-off valve is not completely opened.	2. Check and completely open the water shut-off valve.
	3. Small amount of water has been heated.	3. Increase the hot water flow at the faucet to allow more water to flow through the water heater.
Fan continues to rotate after the hot water faucet is closed.	The post-purge cycle clears flue gases.	Normal operation.

CARING FOR YOUR WATER HEATER



Service Error Code Chart

Your water heater has an electronic diagnostic system built into it. When the water heater finds a problem, it displays an error code in the LED display on the remote control. The chart on page 26 lists the error codes along with the possible problem and solution. Using this chart may help you diagnose and/or fix a problem you may be experiencing. Please refer to this chart before calling for service assistance.

⚠ DANGER: Shock Hazard-Make certain power to the water heater is OFF before removing protective cover for any reason. Electric shock will cause death or serious personal injury.

⚠ WARNING: For Your Safety DO NOT attempt repair of electrical wiring, gas piping, remote control, burners, vent connectors, or other safety devices. Refer repairs to a qualified service technician.

When an error code is displayed:

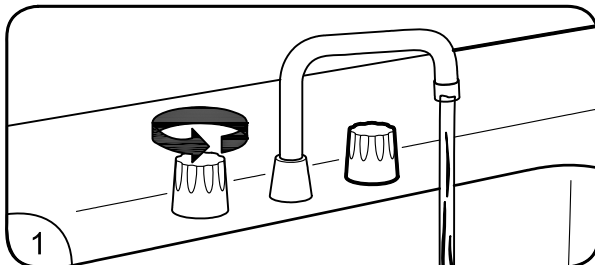

1 Turn off all the hot water faucets.

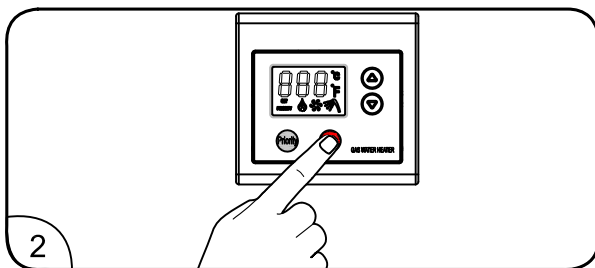

2 Turn off the water heater by pressing the POWER ON/OFF button on the remote control.

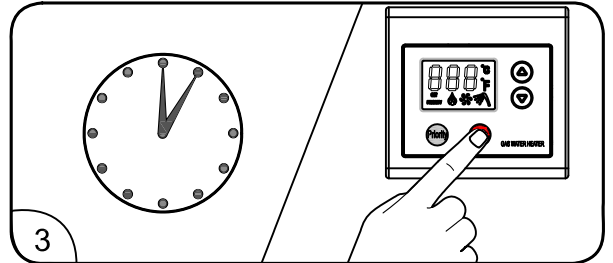

3 Wait about 5 minutes; then restart the water heater by pressing the POWER ON/OFF button.

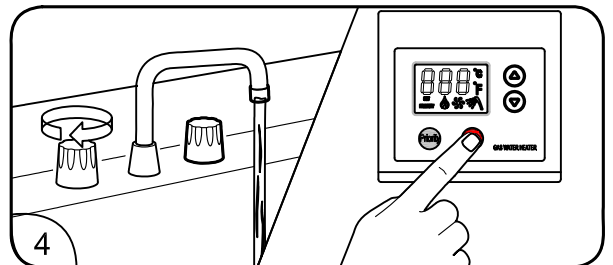

4 Turn on a hot water faucet and recheck the remote control display.

If the error code remains in the display:

1. Turn off the hot water faucet.
2. Turn off the water heater.
3. Unplug the water heater from power, wait about 30 seconds and plug back in.
4. Follow the error code chart information.
5. Restart the water heater, turn on a hot water faucet, and recheck the remote control display.

If the error code is still showing:

1. Turn off the hot water faucet.
2. Turn off the water heater.
3. Make note of the displayed error code and call for service assistance. See "Call for Assistance" section on page 27 .

NOTICE: If the displayed error code is not listed in the chart, immediately turn off the water heater and call for service assistance.

CARING FOR YOUR WATER HEATER



Service Error Code Chart (cont.)

Maintenance Code	Description	Possible Cause	
1	Protection due to temp. sensor at water inlet	Open or short circuit of temp sensor at water inlet	The possible cause information is just for reference only. Please contact our after-sale service immediately in case of any malfunction.
10	Protection due to flame feedback signal	There is flame signal feedback during pre-check before appliance starts up.	
11		Fail to ignite	
12		The continuous combustion goes off accidentally.	
13	Protection due to thermostat	Thermostat is not connected when appliance starts up.	
		Thermostat becomes disconnected during normal combustion.	
30	Protection due to air pressure	There is air pressure signal feedback during pre-check before appliance starts up.	
31		Flue blockage protection is already activated before appliance starts up.	
32		Flue blockage protection becomes activated during normal combustion.	
40	Protection due to fan	Fan is not working; or there is no fan rotating signal.	
42	Protection due to fan revolving speed	Revolving speed of the fan ≥ 600 r/min after power and water supply is on	
		Turn off the appliance for 45s after operation and restart water supply; revolving speed of the fan ≥ 600 r/min	
50	Protection due to high temp.	Outlet water temp. $> 80^{\circ}\text{C}$ (equal to 176°F)	
51		Inlet water temp. $> 75^{\circ}\text{C}$ (equal to 167°F)	
60	Protection due to temp. sensor at water outlet	Open or short circuit of temp sensor at water outlet	

IF YOU NEED SERVICE



Call for Assistance

- All questions, adjustments, repairs, and/or routine maintenance should be directed to your installer, plumbing contractor, or licensed service agent. If your contacts have moved or are not available, please refer to the telephone directory, commercial listings, or local utility company for qualified service assistance.

- If your problem has not been solved to your satisfaction, contact the manufacturer national service department at the following address:

XX
 XXXXXXXXXXXXXXXXXXXX
 XXXXXXXXXXXXXXXXXXXXXXXXXXXXXXXX
 Phone: XXXXXXXXXXXX

When contacting the manufacturer, the following information will be requested:

- Model and serial number. (See page 8 or the rating plate on the side of the water heater.)
- Address where the water heater is located.
- Name and address of installation contractors (page 8) and all qualified service companies that have worked on the water heater.
- Original installation date. (See page 8.)
- Dates any service or preventive maintenance was performed.
- Details of the persisting problem.
- List of businesses that have tried to fix this problem, along with dates of service.

Care Instructions
Service Information



INSTALLATION INSTRUCTIONS FOR THE CONTRACTOR

INSTALLATION INSTRUCTIONS



Standards Compliance

This water heater must be installed in accordance with these instructions, local codes, and utility company requirements.

In the United States where local codes are not available, use the latest edition of the American National Standard/National Fuel Gas Code. A copy of the Fuel Gas Code can be purchased from either the American Gas Association, 400 North Capitol Street Northwest, Washington, DC 20001, as ANSI standard Z223.1 or National Fire Protection Association, 1 Batterymarch Park, MA 02269 as NFPA 54.

General



Choosing a Location

WARNING: Fire Hazard-

Combustible construction refers to adjacent walls and ceilings and should not be confused with combustible or flammable products and materials. Combustible materials, such as clothing, cleaning materials, or flammable liquids must not be placed against or next to the water heater. Fire or explosion could occur causing death, personal injury, and/or product damage.

A gas-fired water heater should never be installed in a space or room where liquids with flammable vapors are used or stored. Such liquids include gasoline, LP gas (butane or propane), paint, adhesives and their thinners solvents, or removers. Flammable vapors carry long distances from where they are used or stored. The open flame of the water heater's main burner can ignite these vapors causing an explosion or fire.

NOTICE: Elevating a gas-fired water heater will reduce but NOT eliminate the possibility of lighting the vapor of flammable liquid which may be improperly stored or accidentally spilled.

NOTICE: This water heater should not be located in an area where water leakage of the heat exchanger or connections will result in damage to the area adjacent to it or to lower floors of the structures. When such areas cannot be avoided, install a suitable catch pan with an adequate drain under the water heater.

Provisions for adequate combustion and ventilation air. Adequate clearances for servicing and proper operation.

For other than a direct vent appliance must be located as close as practicable to a chimney or gas vent.

The appliance should be located in area where leakage of the tank or connections will not result in damage to the area adjacent to the appliance or to lower floors of the structure.

When such locations cannot be avoided, it is recommended that a suitable drain pan, adequately drained, be installed under the appliance. The pan must not restrict combustion air flow.

If a water heater is installed in a closed water supply system, such as one having a backflow preventer in the cold water supply line, means shall be provided to control thermal expansion.

Contact the water supply or local plumbing inspector on how to control this situation.

INSTALLATION INSTRUCTIONS

General

Choosing a Location (cont.)

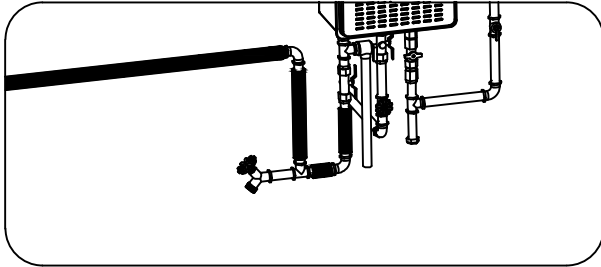

- Long hot water lines should be insulated to conserve water and energy.
- The water heater and water lines should be protected from exposure to freezing temperatures.

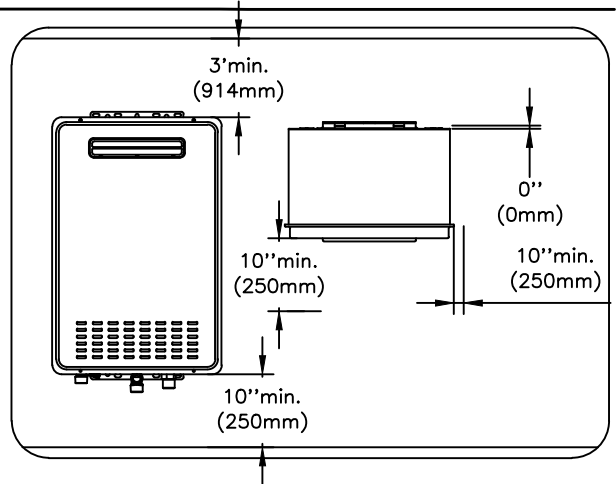

- Minimum water heater clearances from combustible and noncombustible construction are as follows:
 - 3 ft.(91.4 cm) for top
 - 0 in.(0 cm)for rear with support bracket(s)
 - 10 in.(25 cm) from the bottom, sides, and front



- DO NOT install the water heater in areas prohibited by National Fuel Gas Code in U.S. installation or CAN/CSA B149.1 in Canadian installation.



- DO NOT install the water heater where it is subject to vibrations.



- DO NOT install the water heater in a recreational vehicle, mobile home, boat, or other watercraft.



- DO NOT install the water heater near vents for heating and cooling unless a minimum clearance of 4 ft(1.2m) is maintained.

INSTALLATION INSTRUCTIONS

Figure 2-B
Other than direct vent terminal clearances
(See Clauses 4.30.2, and E.1.)

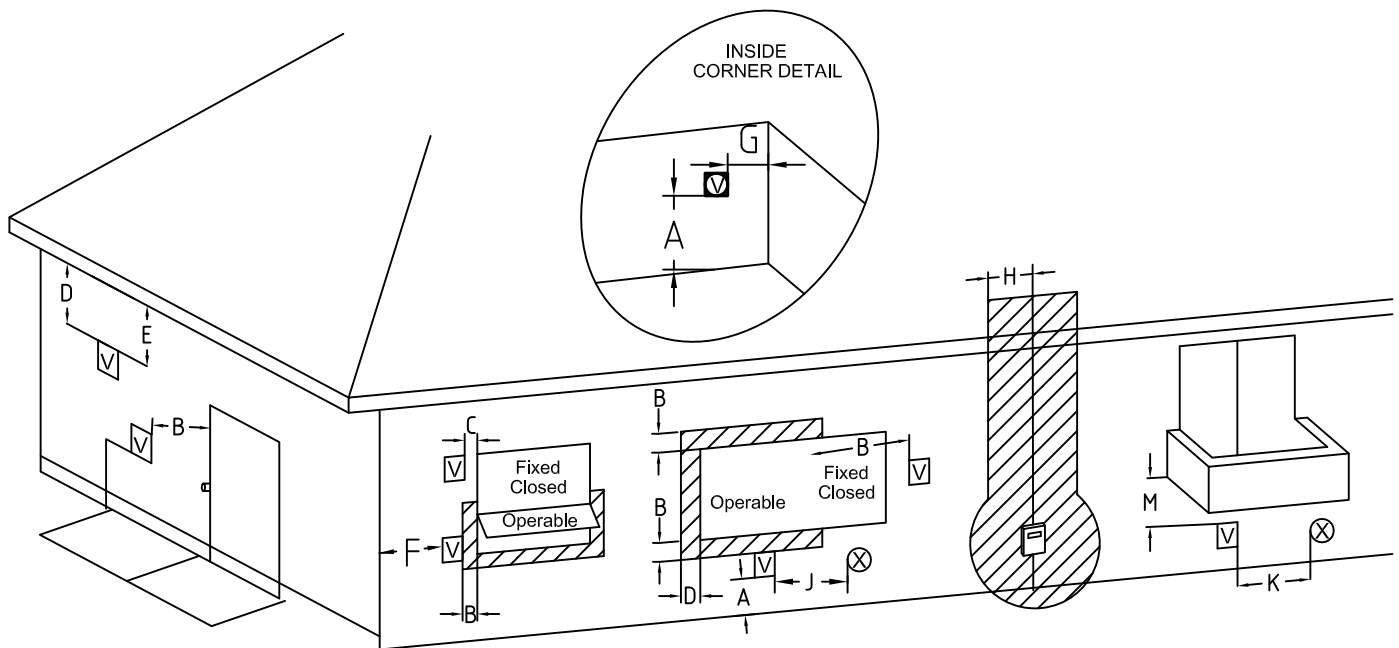

- ☑ Vent Terminal
- ⊗ Air Supply Inlet
- Area Where Terminal is Not Permitted

		Canadian Installations ¹	US installations ²
A=	Clearance above grade, veranda, porch, deck, or balcony.	12 in. (30 cm)	12 in. (30 cm)
B=	Clearance to window or door that may be opened.	6 in. (15 cm) for appliances ≤ 10,000 Btuh (3 kW), 12 in (30 cm) for appliances ≥ 10,000 Btuh (3 kW) and ≤ 100,000 Btuh (30 kW), 36 in (91 cm) for appliances > 100,000 Btuh (30 kW)	4 ft (1.2 m) below or to side of opening; 1 ft (300 mm) above opening
C=	Clearance to permanently closed window.	*	*
D=	Vertical clearance to ventilated soffit located above the terminal within a horizontal distance of 2 ft (61 cm) from the centerline of the terminal.		
E=	Clearance to unventilated soffit.	*	*
F=	Clearance to outside corner.	*	*

INSTALLATION INSTRUCTIONS

Figure 2-B (Concluded)

		Canadian Installations ¹	US installations ²
G=	Clearance to inside corner.	*	*
H=	Clearance to each side of centerline extended above meter/regulator assembly.	*	*
I=	Clearance to service regulator vent outlet	Above a regulator within 3 ft (91 cm) horizontally of the vertical centerline of the regulator vent outlet to a maximum vertical distance of 15 ft (4.5 m)	*
J=	Clearance to nonmechanical air supply inlet to the combustion air inlet to any building or other appliance.	6 in.(15 cm) for appliances ≤ 10,000 Btuh (3 kW), 12 in (30 cm) for appliances > 10,000 Btu (3 kW) and ≤10,000 Btuh (3 kW) , 36 in (91 cm) for appliances > 100,000Btuh (30 kW)	4 ft (1.2 m) below or to side of opening; 1 ft (300 mm) above opening
K=	Clearance to mechanical air supply inlet	6 ft (1.33 m)	3 ft (91 cm) above if within 10 ft (3 m) horizontally
L=	Clearance above paved sidewalk or paved driveway located on public property.	7 ft (2.13 m) [†]	7 ft (2.13 m) [†]
M=	Clearance under veranda,porch,deck, or balcony.	12 in (30 cm) [‡]	*

☆ For clearances not specified in ANSI Z223.1/NFPA 54 or CAN/CSA B149.1, one of the following shall be indicated:

- a) a minimum clearance value determined by testing in accordance with Clouse 5.21, Draft hoods, or
- b) a reference to the following footnote:"Clearance in accordance with local installation codes and the requirements of the gas supplier."

† A vent shall not terminate directly above a sidewalk or paved driveway that is located between two single-family dwellings and serves both dwellings.

‡ Permitted only if veranda porch, deck, or balcony is fully open on a minimum of two sides beneath the floor.

Notes:

- 1) In accordance with current CSA B149.1 , Natural Gas and Propane Installation Code.
- 2) In accordance with current ANSI Z223.1/NFPA 54, National Fuel Gas Code.

INSTALLATION INSTRUCTIONS



Product Inspection

- Visually inspect the water heater for any possible damage.
- Check the rating plate on the water heater to make sure the water heater was designed to be used with the supplied type of gas (natural or LP).
- Verify that all included supplied parts are present as shown.

General

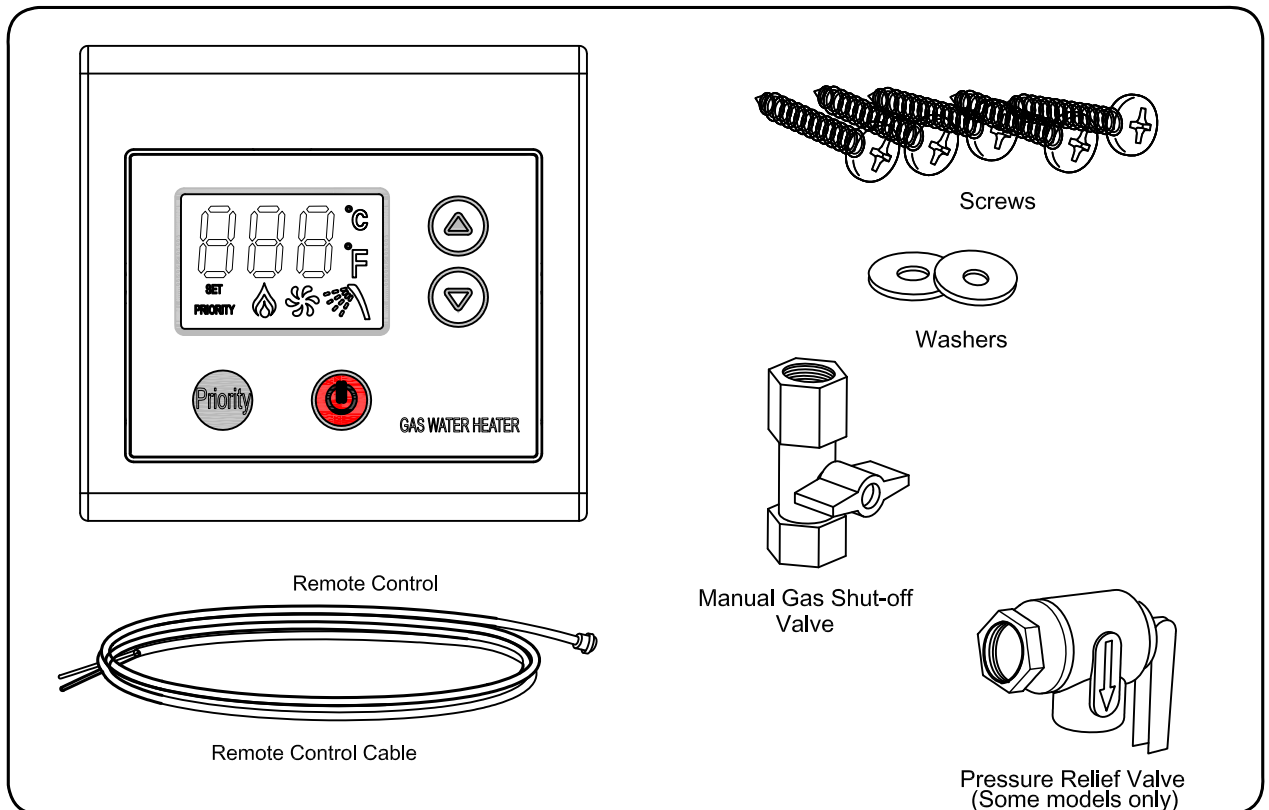

Water Heater Installation

Corrosive Atmosphere

NOTICE: The water heater should not be installed near an air supply containing halogenated hydrocarbons where contaminants can enter the combustion air supply.

Avoid installing a water heater in any of the following locations: beauty shops, dry-cleaning establishments, photo processing labs, and storage areas for liquid and powdered bleaches or swimming pool chemicals. These locations often contain such halogenated hydrocarbons.

The air supply containing halogenated hydrocarbons is safe to breathe, but when passed through a gas flame, corrosive elements are released that will shorten the life of any gas-burning appliance.

Propellants from common spray cans or gas leaks from A/C and refrigeration equipment are highly corrosive after passing through a flame.

NOTICE: The water heater warranty is invalid when the failure is due to operation in corrosive conditions.

INSTALLATION INSTRUCTIONS

General



Water Heater Installation (cont.)

Typical Installation of Outdoor Water Heater (No Venting Required)

This water heater is for OUTDOOR installation only.

⚠ WARNING:

It is designed for outdoor installation only. Any other type of installation can result in death, personal injury, and/or and/or damage to the product or property.

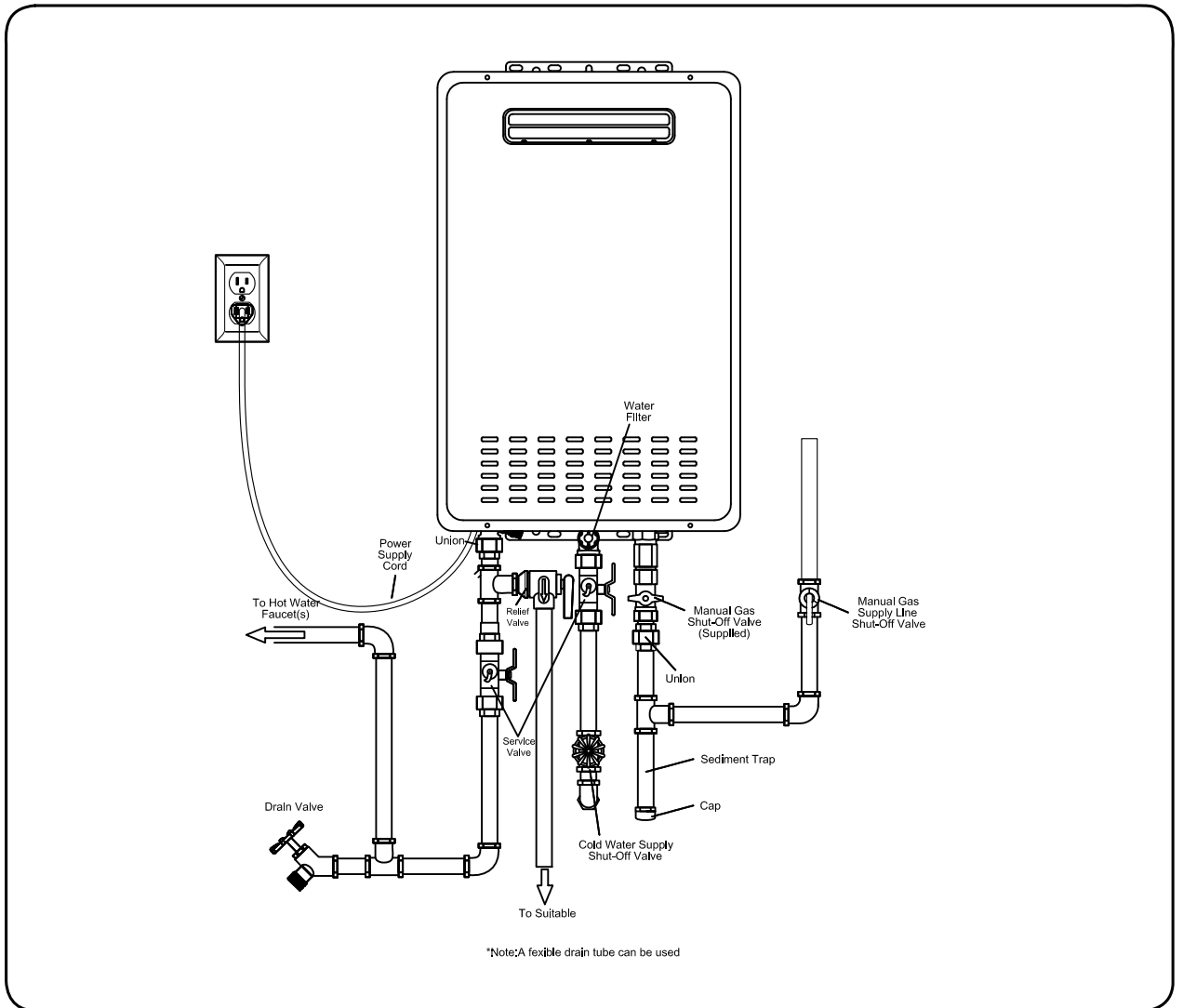

INSTALLATION INSTRUCTIONS

Mounting the Water Heater

⚠ CAUTION: Reinforcement of the wall is required where the wall is not strong enough to hold the water heater. Failure to do so could result in personal injury and/or property damage.

The mounting location for the water heater should allow for easy access and operation.

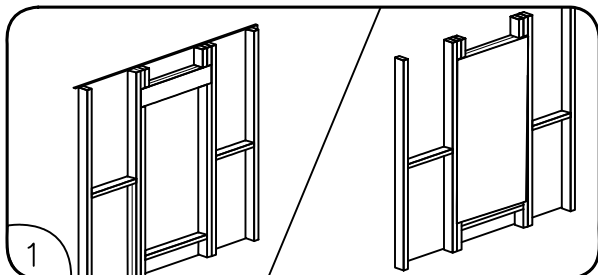

The water heater is designed to be installed either inside the wall cavity between the wall studs or outside the wall cavity. Either installation requires the water heater to be supported with a wooden support brace between the wall studs, or a piece of wood that is equal in size to the water heater and securely attached to the wall studs before the water heater is attached to it. This piece of wood can be installed inside or outside of the wall. Use wood screws to secure brackets to wall. If mounting to a concrete wall, use lag bolts designed for concrete.

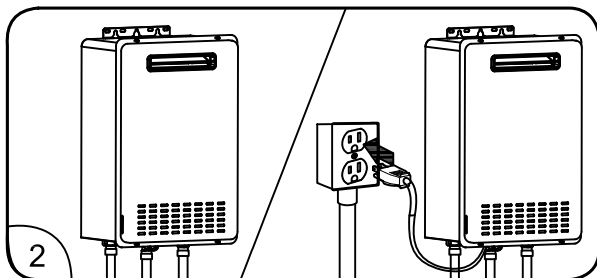

Make sure the proper electrical outlet or supply (120 VAC/60Hz) is available and located near the unit. Outdoor models come with a 6-ft.(1.8-m) power cord.

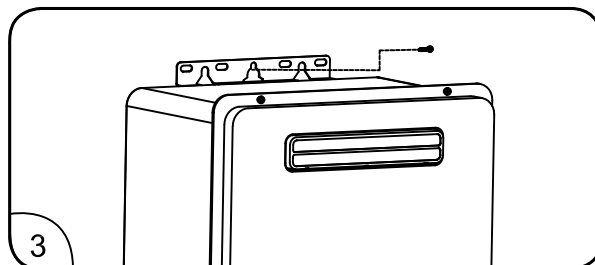

Position the upper mounting bracket and partially install the center mounting screw. The clearance between the screw head and the wall should be about 1/8 in.(0.3 cm). Hang the upper bracket on the screw.

NOTICE: The image above may differ in appearance from your water heater.

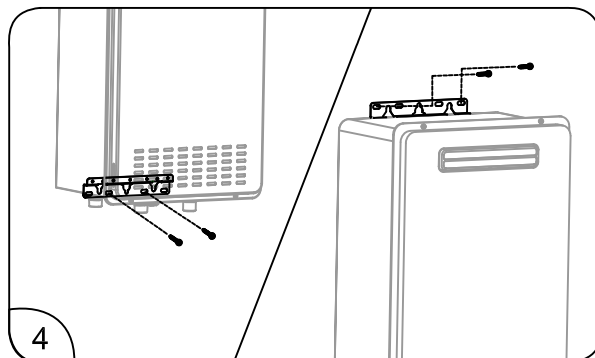

Using two mounting screws and washers, secure the lower mounting bracket to the wall. Then, secure the upper mounting bracket to the wall with two mounting screws and washers.

INSTALLATION INSTRUCTIONS

Horizontal Vent Considerations

⚠️ WARNING: Moisture in the flue gas will condense as it leaves the vent terminal. Some discoloration to the exterior of the building is to be expected. However, improper location or installation can result in severe damage to the structure or exterior finish of the building.

- DO NOT locate vent terminal on the side of a building with prevailing winter winds. This will help prevent water lines from freezing and moisture from freezing on walls and under eaves.
- DO NOT locate vent terminal too close to shrubbery, as flue gasses may damage them. A minimum distance of 4 ft. (1.22 m) is recommended.
- All painted surfaces should be primed to lessen the chance of physical damage. Painted surfaces will require maintenance.
- Guard against accidental contact with people and pets.

OUTDOOR TANKLESS WATER HEATERS

- Install outdoor water heater such that air inlet and flue outlet are above anticipated snow level.

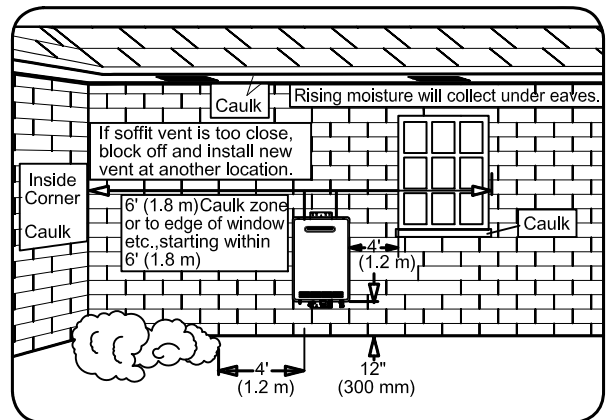

INSTALLATION INSTRUCTIONS



Water Supply

CAUTION: This water heater MUST ONLY be used with the following water supply conditions to prevent product damage and operation failure.

- Clean, potable water free of corrosive chemicals, sand, dirt, and other contaminants.
- Inlet water temperatures above 32°F(0°C), but not exceeding 118°F(48°C).

- DO NOT reverse the HOT and COLD water connections.
- DO NOT connect this water heater to water lines previously used for space heating. All water piping and components shall be suitable for potable water.
- With recommended water quality (See chart below).

Chart for Recommended Water Quality Levels

pH	TDS (Total Dissolved Solids)	FreeCarbon Dioxide (CO ₂)	Total Hardness	Aluminum	Chlorides	Copper	Iron	Manganese	Zinc
6.5–8.5	Up to 500 mg/L	Up to 15 mg/L	Up to 200 mg/L	Up to 0.2mg/L	Up to 200 mg/L	Up to 1.0 mg/L	Up to 0.3 mg/L	Up to 0.05 mg/L	Up to 1.0 mg/L

Thermal Expansion

Determine if a check valve exists in the inlet water line. Check with your local water utility company. It may have been installed in the cold water line as a separate back flow preventer, or it may be part of a pressure reducing valve, water meter or water softener. A check valve located in the cold water inlet line can cause what is referred to as a "closed" water system. A cold water inlet line with no check valve or back flow prevention device is referred to as an "open" water system. As water is heated, it expands in volume and creates an increase in the pressure within the water system. This action is referred to as "thermal expansion". In an "open" water system, expanding water and the resulting pressure increase which exceeds the capacity of the water heater, flows back into the city main where the pressure is easily dissipated.

A "closed" water system, however, prevents the expanding water from flowing back into the main supply line, and the result of "thermal expansion" can create a rapid and dangerous pressure increase in the water heater and system piping.

This rapid pressure increase can quickly reach the safety setting of the relief valve, causing it to operate during each heating cycle. Thermal expansion, and the resulting rapid and repeated expansion and contraction of components in the water heater and piping system can cause premature failure of the relief valve, and possibility the heater itself.

NOTICE: Replacing the relief valve will not correct the problem!

The suggested method of controlling thermal expansion is to install an expansion tank in the cold water line between the water heater and the check valve.

The expansion tank is designed with a built-in air cushion that compresses as the system pressure increases. This relieves the over-pressure condition and eliminates the repeat operation of the relief valve. For other approved methods of thermal expansion, contact an installing contractor, water supplier, or plumbing inspector.

Water Supply Connections

CAUTION: IMPORTANT--DO NOT apply heat to the HOT or COLD water connections. If sweat connections are used, sweat tubing to the adapter before fitting the adapter to the water connections on the water heater. Any heat applied to the water supply fittings will permanently damage the internal components of the water heater.

NOTICE: In cold environments, ice can accumulate in the water heater's connectors. Plug in the water heater power cord for approximately 10 minutes before making these connections. This will melt any ice buildup.

Plumbing should be carried out by a qualified plumbing contractor in accordance with local codes.

Only use approved plumbing materials.

To allow the full flow capacity, it is recommended to keep water inlet and outlet pipes 3/4" (1.9 cm) diameter or larger.

To conserve energy and to prevent freezing, insulate both COLD and HOT water supply lines. DO NOT insulate the drain line or pressure-relief valve.

Recirculation

Direct recirculation is allowed, provided the loop is thermostatically controlled, and a timer is used to turn the pump off during off peak periods. The pump must be sized for a minimum of 5 pgm at 25 ft of head plus building head. A 10°F difference between the loop thermostat setting and water heater temperature setting must be maintained.

INSTALLATION INSTRUCTIONS



Water Supply

Water Supply Connections (cont.)

To ensure proper operation of the water heater, follow these water pressure guidelines.

- Operation of the water heater requires a minimum water pressure of 14 psi (97 kPa) and a minimum water flow rate of 0.4 gpm (1.5 lpm).
- Water pressure of 40 psi (276 kPa) is required to achieve maximum flow rate.
- To maintain proper performance, there must be sufficient water supply pressure.

$$\begin{aligned} \text{Required Water Pressure} = & \\ & \text{Min. Operating Water Pressure} \\ & \quad (14 \text{ psi } [97 \text{ kPa}]) \\ & + \text{ Pipe Pressure Loss} \\ & + \text{ Faucet Pressure Loss} \\ & + \text{ Safety Margin} \\ & \quad (\text{more than } 5 \text{ psi } [34 \text{ kPa}]). \end{aligned}$$

- To supply HOT water to upper floors, additional water pressure will be required (0.44 psi [3 kPa] per foot of height). Calculate the distance between the water inlet of the water heater (ground level) to the HOT water faucet farthest away from the water heater (upper floor level).
- Well water systems should be set to ensure a minimum system pressure of 40psi (276 kPa). The pressure should remain constant and stable during the operation of the water heater.
- Gravity water pressure is not recommended. When the water is supplied from a water supply tank, the height of the tank, the diameter of the supply pipes, and their relation to water pressure need to be taken into consideration.

Water Supply Installation

NOTICES :

- Use only Teflon tape on all COLD and HOT water connections.
- If the water flow resistance of a showerhead is too high, the burner in the water heater will fail to ignite. Keep all showerheads clean from debris that could cause additional pressure drop.
- If using mixing valves on the outlet, choose one that prevents COLD water pressure from overcoming HOT water pressure.
- If multiple water heaters are installed in a manifold system, the water piping MUST be in "parallel" and the water pressure at each water heater should be 40 psi (276kPa).

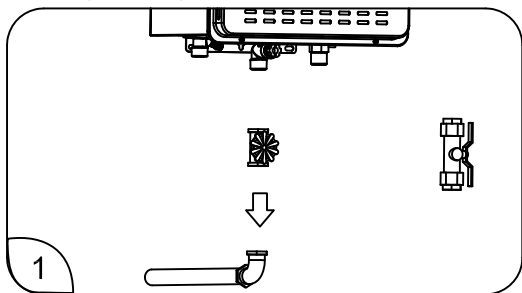

1 Install a COLD water shut-off valve near the inlet line on the water heater. This valve will be used for servicing and draining purposes.

NOTICE: It is not recommended to use pipes with smaller diameters than the water supply connection of the water heater.

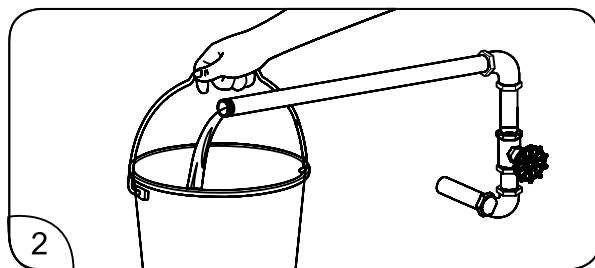

2 Before attaching the water line to the water heater, open the shut-off valve. Run the water until it has purged all contaminants (sand, debris, air, caulking, etc.).

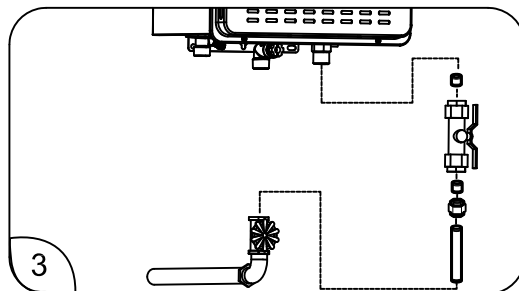

3 Install a service valve on the end of the COLD water supply line and connect it to the water inlet on the water heater.

INSTALLATION INSTRUCTIONS

Water Supply Installation (cont.)

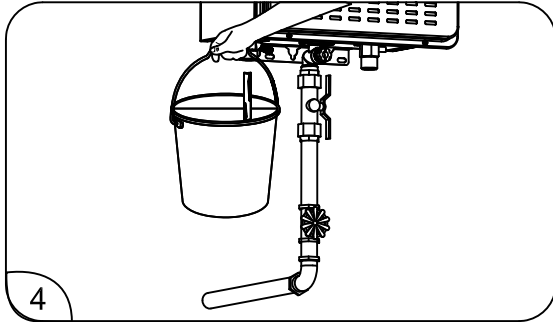

Open the shut-off valve in the COLD water Inlet line to check the water flow through the water heater.

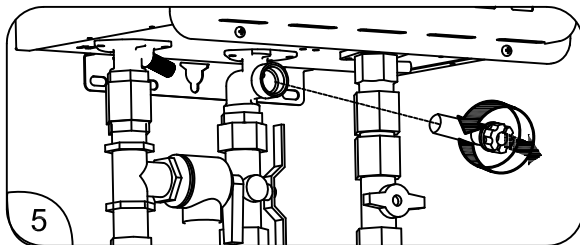

Close the shut-off valve and remove, clean, and replace the water filter.

NOTICES:

- Be sure to connect the COLD water inlet and the HOT water outlet as shown on the water heater. If reversed, the water heater will not function.
- The flow rate of HOT water may vary when more than two faucets (e.g. appliances, fixtures, etc.) are being used simultaneously.
- The pipes MUST be completely drainable. If the HOT water faucets are located at a point higher than the water heater, place a drain valve at the lowest point.

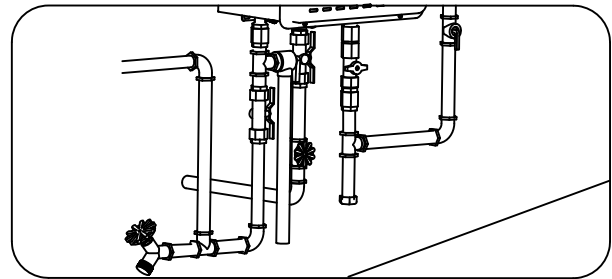

It is recommended to use unions and flexible copper connections at the COLD and HOT water lines. They allow the water heater to be disconnected easily for servicing.

Use the following guidelines when connecting the HOT WATER OUTLET:

- Connections between the water heater and point(s) of use should be as short as possible.
- Local codes shall govern the piping used for water connections.
- To conserve energy and prevent freezing, insulate both COLD and HOT water supply lines. DO NOT insulate drain line or pressure-relief valve.

Water Piping Arrangement With Service Valve Kit

Service valve kits can attach to all tankless water heater systems. All kits include two full-port isolation valves to be used in the COLD and HOT water lines. When installed, these valves allow one person full diagnostic testing and ease of flushing the system. Contact your distributor or place of purchase for availability and installation information.

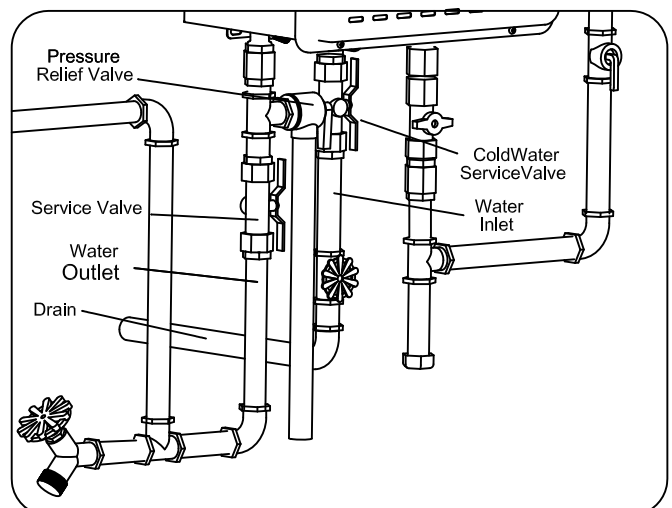

INSTALLATION INSTRUCTIONS



Water Supply (cont.)

Relief Valve

A new pressure-relief valve, complying with the Standard for Relief Valves and Automatic Gas Shut-Off Devices for Hot Water Supply Systems, ANSI Z21.22/ CSA 4.4, must be installed at the hot water outlet connection of the water heater during installation. Local codes shall govern the installation of any relief valve.

Relief valve is NOT attached with Gas Water Heater.

NOTICES:

- The following drawing illustrates a pressure-only relief valve. If local codes require a combination temperature and pressure-relief valve, you may need to install an extension piece to ensure that the valve probe is not directly in the flow path of the water.
- A pressure relief valve supplied with this water heater must be installed as shown below.
- Manual operation of relief valves should be performed at least once a year.
- If the relief valve on the system discharges periodically, a problem exists. Turn off the water heater, unplug the unit, and call for service.

For safe operation of the water heater, be sure that:

- The pressure rating of the relief valve must not exceed 150 psi (1,034 kPa) or the maximum working pressure of the water heater. (See the rating plate on the water heater.)
- The BTUH rating of the relief valve must equal or exceed the BTUH input of the water heater. (See the rating plate on the water heater.)
- No valve of any type should be installed between the relief valve and the water heater.
- Discharge from the relief valve should be piped to a suitable drain. Piping used should be of a type approved for the distribution of hot water.
- HOT and COLD water lines should be insulated up to the water heater. See page 54.
- The discharge line must be NO SMALLER than the outlet of the relief valve. The drain line must pitch downward to allow for complete drainage of the line and the valve.
- The end of the discharge line should not be threaded or concealed and should be protected from freezing. No valve of any type, restriction, or reducer coupling should be installed in the discharge line.

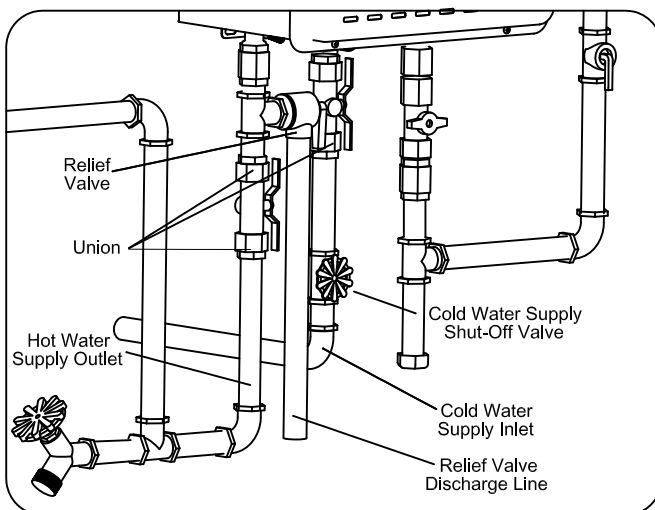

One end of the relief valve discharge line connects to the HOT water outlet pipe as shown above. The other end of the pipe should be routed to a suitable drain to eliminate potential water damage.

INSTALLATION INSTRUCTIONS

Hot and Cold Pipe Insulation Installation

⚠️ WARNINGS :

- When pipe insulation is not rated for the appropriate weather conditions, install electric heat tracing or equivalent to prevent freezing of the pipes.
- DO NOT insulate or block drain valve on the hot outlet fitting.
- If pipes are allowed to freeze, the water heater and the pipes may malfunction or leak due to freezing water.

NOTICE : The hot and cold water supply pipes should be insulated to provide additional freeze protection.

For increased energy efficiency, use pipe insulation as shown in the diagram. Insulate the pipes all the way to the top. DO NOT cover any drain or pressure-relief valve(s).

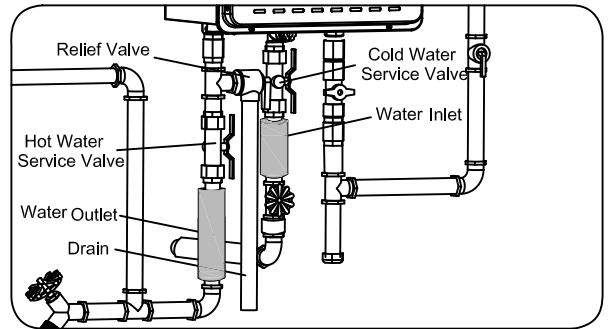

INSTALLATION INSTRUCTIONS



Gas Supply

Gas Supply System

⚠WARNING: DO NOT attempt to convert this water heater for use with a different type of gas other than the type shown on the rating plate. Doing so could result in death, personal injury, explosion or fire, product damage, and/or poor operating conditions or performance.

NOTICES:

- Gas piping shall be in accordance with local utility company requirements and/or in the absence of local codes, use the latest edition of National Fuel Gas Code (NFGC), ANSI Z233.1.
- Apply a thin coat of pipe compound to all threaded male ends. Compound must be of the type resistant to the action of LP gas.
- To ensure proper water heater operation, the gas pipe and gas meter must be sized correctly.
- If flexible connectors are used, the minimum inside diameter must be 3/4" or greater and the rated capacity of the connector must be equal to or greater than the BTU capacity of the water heater. See manufacturer information for the gas connector. Lengths over 36 inches are not recommended.
- DO NOT use excessive force when tightening the pipe sections. Excessive force can damage the water heater, especially when Teflon pipe compound is used.

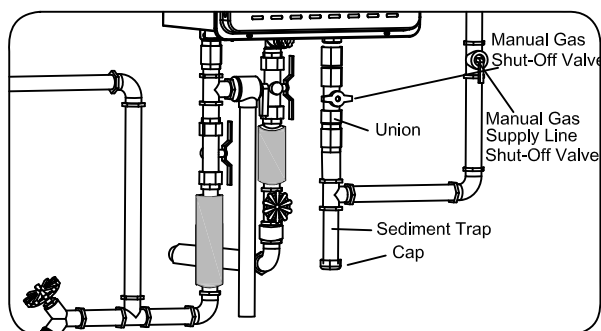

Gas Piping

Pipe-Sizing Procedure - Example

The gas supply system must be properly sized to ensure the proper operation of this tankless water heater as well as all the gas appliances on the system. Failure to ensure the gas system, (meter, regulators, and piping) are properly sized could result in improper operation of this or other gas appliances. Insufficient gas pressure/supply can cause pilot outages, lockouts, or operating conditions that could lead to an appliance failure, improper combustion, carbon monoxide, sooting, or fire. Gas line sizing is based on gas type, the pressure drop in the system, the gas pressure supplied, and the gas line type. For gas pipe sizing in the United States, refer to the National Fuel Gas Code, (NFPA 54, ANSI Z223.1).

These simplified instructions only address low pressure gas systems using Schedule 40 Metallic Pipe (Black Iron). For hybrid gas systems, high pressure main lines with regulators at the appliances, gas systems piped with corrugated stainless steel tubing (CSST), or Propane gas systems.

Determining the required regulator and gas meter size.

Find the BTU capacity of each appliance on the system. This information is located on a rating label attached to the appliance. Total the BTU of all the appliances together and divide that by the heating value of the fuel (for natural gas the average is 1,024 or 2,546 for propane). This will give you the total cubic feet per hour of gas required for the system.

At your gas meter/regulator there will be a rating plate that gives the cubic feet per hour capacity of that equipment. If the total gas required for the system is greater than the rating of the meter/regulator then the local gas company will need to be contacted in order to upgrade the meter/regulator for the system.

$$\text{Cubic Feet Per Hour (CFH)} = \frac{\text{Gas Input of Water Heater (BTU/HR)}}{\text{Heating Value of Gas (BTU/FT)}}$$

INSTALLATION INSTRUCTIONS

Gas Supply (cont.)

Determining the required pipe size.

The gas system is designed to operate at a certain maximum pressure drop. A pressure drop greater than what is permissible can cause operational issues with the gas appliances. The National Fuel Gas Code (NFPA 54, ANSI Z233.1 2012) allows for three pressure drop levels, a 0.3 inch W.C., (see table 2); a 0.5 inch W.C., (see table 3) and a 3.0 inch W.C., (see table 4) pressure drop for natural gas. Only a 0.5 inch W.C. pressure drop is allowable with Propane (see table 5).

Measure the inlet gas pressure to the system using a manometer. For Natural Gas, if the inlet pressure is less than 8.0 inches W.C. then use Table 2 or 3 for your gas pipe sizing. Table 4 can only be used if the inlet gas pressure is 8.0 inches W.C. or greater.

The gas piping system consists of a main trunk line that runs from the meter/regulator and branch lines that run from the trunk line to the individual appliances. A branch may carry gas for more than one appliance.

The trunk line must be sized to carry the entire load of all the gas appliances on the system. As with determining the meter/regulator size, total the BTU of all the appliances together and divide that by the heating value of the fuel (for natural gas the average is 1,024 or 2,546 for propane). This will give you the total cubic feet per hour of gas required for the trunk line. Measure the total length of the line Refer to Table(s) 2, 3, or 4 and find the number closest to but higher than the total cubic feet per hour requirement calculation. This will tell you the minimum size that the trunk line must be.

Each branch line must be sized to carry the load of the appliance(s) attached to it. If more than one appliance is on a branch total the BTU and as with the trunk line divide that by the heating value of the fuel. Refer to Table(s) 2, 3, or 4 and find the number closest to but higher than the total cubic feet per hour requirement calculation for the branch and appliance(s). This will tell you the minimum size for that branch line and appliance.

Final Considerations

If this water heater is replacing an existing water heater, it is important to verify the capacity of the gas system. Check the capacity of the meter/regulator, and verify the pipe lengths and sizes.

An improperly sized gas system will cause operational issues with this water heater. Other appliances on the gas system may be affected as well.

Flexible Gas Connectors may be used however the BTU capacity of the connector must be checked. Each connector has a capacity label on it, verify that the connector has a BTU capacity greater than that of the water heater. An undersized flexible gas connector will cause operational issues with this water heater.

Half-inch gas lines are permissible provided the gas system meets certain requirements. First, the gas pressure on the system must be 8.0 inch W.C. or greater. Second the capacity of the pipe as outlined in Table 4 is followed. If the existing pipes are too small it could cause a pressure drop greater than 3.0 inch W.C. and will cause operational issues with this water heater as well as other gas appliances on the system.

Gas Supply

INSTALLATION INSTRUCTIONS



Gas Supply (cont.)

This is an example, in US, refer to current National Fuel Gas Code, NFPA 54 for correct pipe sizing chart, and in Canada, refer to current Natural Gas and Propane Installation Code CAN/CSA B149.1.

Gas Supply

Table 2-Pipe-Sizing-Natural Gas					
Schedule 40 Metallic Pipe (Black Iron) Inlet System Pressure: Less than 2 PSI (55 inches W.C.) Allowable Pressure Drop: 0.3 inches W.C. Specific Gravity:0.60 (Capacity in cubic feet per hour)					
Length	Pipe Size (Inches)				
	½	¾	1	1¼	1½
10	131	273	514	1,060	1,580
20	90	188	355	726	1,090
30	72	151	284	583	873
40	62	129	243	499	747
50	55	114	215	442	662
60	50	104	195	400	600
70	46	95	179	368	552
80	42	89	167	343	514
90	40	83	157	322	482
100	38	79	148	304	455

Information in this chart obtained from NFPA 54, ANSI Z233.1-2012 able 6.2 (a)

Table 3 - Pipe - Sizing - Natural Gas					
Schedule 40 Metallic Pipe (Black Iron) Inlet System Pressure: Less than 2 PSI (55 inches W.C.) Allowable Pressure Drop: 0.5 inches W.C. Specific Gravity: 0.60 (Capacity in cubic feet per hour)					
Length	Pipe Size (Inches)				
	½	¾	1	1¼	1½
10	172	360	678	1390	2090
20	118	247	466	957	1430
30	95	199	374	768	1150
40	81	170	320	657	985
50	72	151	284	583	873
60	65	137	257	528	791
70	60	126	237	486	728
80	56	117	220	452	677
90	52	110	207	424	635
100	50	104	195	400	600

Information in this chart obtained from NFPA 54, ANSI Z233.1-2012 able 6.2 (b)

Table 4 - Pipe - Sizing - Natural Gas					
Schedule 40 Metallic Pipe (Black Iron) Inlet System Pressure: 8.0 inches W.C. or greater, but Less than 2 PSI (55 inches W.C.) Allowable Pressure Drop: 3.0 inches W.C. Specific Gravity:0.60 (Capacity in cubic feet per hour)					
Length	Pipe Size (Inches)				
	½	¾	1	1¼	1½
10	454	949	1,787	3,669	5,497
20	312	652	1,228	2,522	3,778
30	250	524	986	2,025	3,778
40	214	448	844	1,733	2,597
50	190	387	748	1,536	2,302
60	172	360	678	1,392	2,085
70	158	331	624	1,280	1,919
80	147	308	580	1,191	1,785
90	138	289	544	1,118	1,675
100	131	273	514	1,056	1,582

Information in this chart obtained from NFPA 54, ANSI Z233.1-2012 able 6.2 (c)

Table 5 - Pipe - Sizing - Natural Gas					
Schedule 40 Metallic Pipe (Black Iron) Inlet System Pressure: 11 inches W.C. Allowable Pressure Drop: 0.5 inches W.C. Specific Gravity: 1.5 (Capacity in cubic feet per hour)					
Length	Pipe Size (Inches)				
	½	¾	1	1¼	1½
10	291	608	1150	2350	3520
20	200	418	787	1620	2420
30	160	336	632	1300	1940
40	137	287	541	1110	1660
50	122	255	480	985	1480
60	110	231	434	892	1340
80	101	212	400	821	1230
100	94	197	372	763	1140
125	89	185	349	716	1070
150	84	175	330	677	1010

Information in this chart obtained from NFPA 54, ANSI Z233.1-2012 able 6.3 (d)

INSTALLATION INSTRUCTIONS

Gas Supply (cont.)

Gas Supply Installation

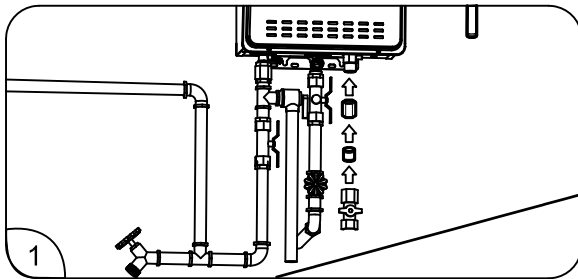

Install the manual gas appliance shut-off valve to the gas connection at the water heater. The shut-off valve is supplied with the water heater.

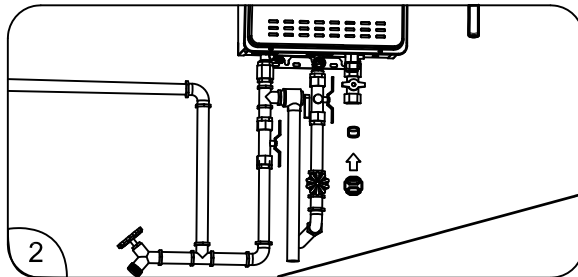

Install a ground joint union or ANSI design-certified semi-rigid or flexible gas appliance connector to the open end of the manual gas appliance shut-off valve. The NFGC, ANSI Z223.1 codes mandate the use of manual gas shut-off valve.

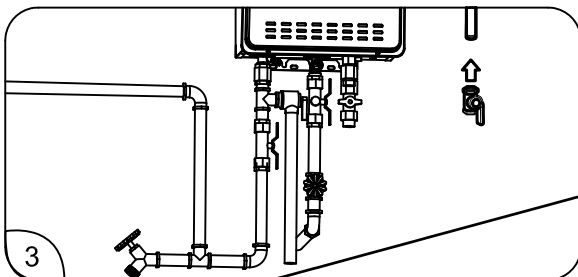

Install a manual gas supply line shut-off valve to the end of the gas supply line.

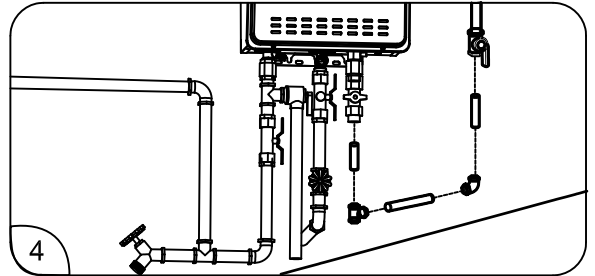

Using the proper-size piping, fittings, and components, build the gas supply line to the water heater.

NOTICE: The gas supply line should be a minimum of 3/4-in. (1.9-cm) black steel pipe or other approved gas piping material.

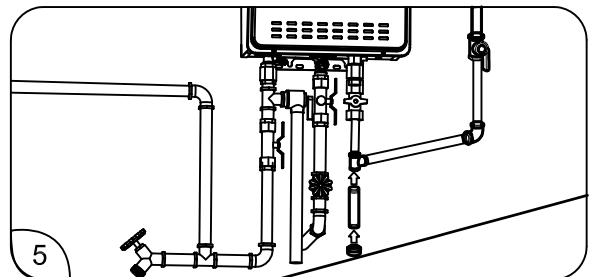

Install a sediment trap at the lowest portion of the gas line.

The inlet gas pressure to the water heater must NOT exceed 10.5 in. w.c. (2.6 kPa) for natural gas and 13 in. w.c. (3.2 kPa) for LP gas. For purposes of input adjustment, the minimum inlet gas pressure (with main burner on) is shown on the water heater rating plate. If high or low gas pressures are present, contact your gas supplier for correction.

INSTALLATION INSTRUCTIONS

Leak Testing

⚠WARNING: Never use an open flame to test for gas leaks, because death, personal injury, and/or property damage can result.

The water heater and its gas connections **MUST** be leak-tested at normal operating pressures before the unit is placed in operation. These tests should also include all factory connections.

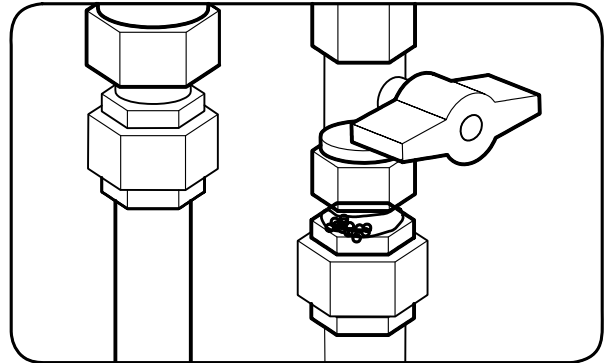

- Turn on the gas shut-off valve(s) to the water heater.
- Use a soapy water solution to test for leaks at all the connections and fittings. If bubbles are seen, it indicates a gas leak that must be corrected.
- Contact a qualified service technician.

Pressure Testing of the Gas Supply System

⚠WARNING: If inlet gas pressure is out of allowable range [4.0" w.c. (1.0kPa) - 10.5" w.c. (2.6kPa)] for Natural Gas, or [8.0" w.c. (2.0kPa) - 13.0" w.c. (3.2kPa)] for LP gas, a gas pressure regulator must be installed to maintain the allowable inlet gas pressure.

The water heater and its manual gas shut-off valve must be disconnected from the gas supply piping system during any pressure testing of the system at test pressures in excess of 1/2 psi (3.5 kPa).

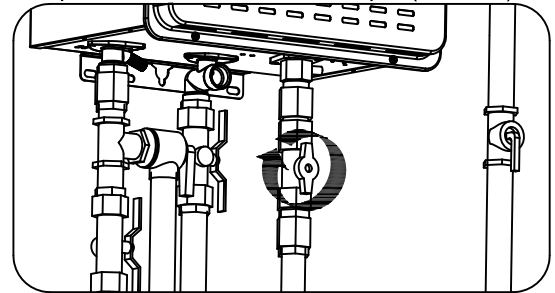

The water heater must be isolated from the gas supply piping system by closing the manual gas shut-off valve during any pressure testing of the gas supply piping system at test pressures equal to or less than 1/2 psi (3.5 kPa).

INSTALLATION INSTRUCTIONS



Gas Supply (cont.)

High-Altitude Installation

The water heater is suitable for installation up to 2,000 ft. (600 m) above sea level. The input rating of this water heater is based on sea level operation. At higher elevations, the actual input rate may be lower than the value listed on the rating label.

NOTICE:

- For installation above 2,000 ft. (600 m) elevation, contact a qualified service technician to make the proper altitude adjustments.

⚠️WARNING: DO NOT install this water heater at elevations above 2,000 ft. (600 m) without the proper adjustments. Please contact your installer, local gas supplier, place of purchase, or the VANWARD Customer Service phone number listed on page 27 in the "Call for Assistance" section.



Electrical Wiring

⚠️DANGER: Shock Hazard-Before servicing the water heater, turn off the electrical power to the water heater at the main disconnect or circuit breaker. Failure to do so will result in death or serious personal injury.

⚠️WARNING: Field wiring connections and electrical grounding must comply with local codes or, in the absence of local codes, with the latest edition of the National Electrical Code, ANSI/NFPA 70.

⚠️CAUTION: Label all wires prior to disconnecting is recommended. Wiring errors can cause personal injury, product damage, and/or dangerous operating conditions. Verify correct operation after servicing.

NOTICES:

- DO NOT connect power until venting installation is complete (see Venting Installation pages 34-46).
- Wait ninety (90) seconds after power is connected for the first time to initiate operation of the water heater.

Power consumption is up to 100 Watts during normal operation, 3-5 Watts during standby, waiting to run, and up to 200 Watts during the freeze protection operation.

Power Cord

- The electric power supply requirement for this water heater is 120 VAC/60 Hz, 2 amps.
- A dedicated circuit is recommended for the water heater. DO NOT connect to a GFCI or AFCI circuit. Multiple units may be connected to a single circuit up

to the circuit rating

- DO NOT use 3-prong to 2-prong adapters. DO NOT use power strips or multiple outlet adapters.

INSTALLATION INSTRUCTIONS

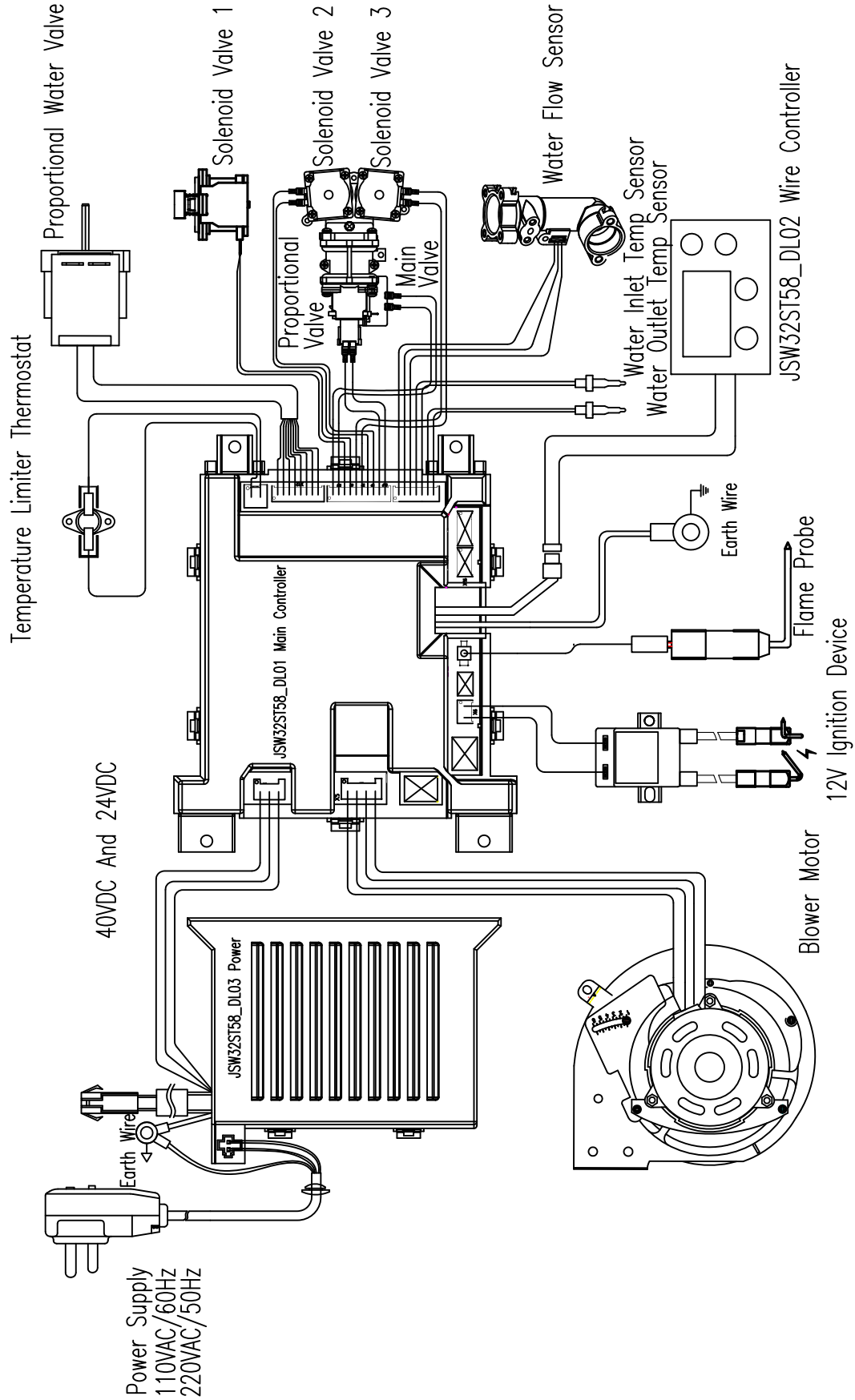

INSTALLATION INSTRUCTIONS

Electrical Wiring (cont.)

Remote Control Selection and Location

⚠️ WARNING: Field wiring connections and electrical grounding must comply with local codes or, in the absence of local codes, with the latest edition of the National Electrical Code, ANSI/NFPA 70.



- DO NOT attempt to disassemble a remote control. All controls are sealed and calibrated for accurate water heater control and operation.

One remote control is provided with the water heater. Up to three remote controls can be used with the water heater. No other manufacturer's controls are suitable for use with this water heater.

Review the following considerations before determining the location of the remote control(s):



- DO NOT install any remote control outdoors or where it can come in contact with water.

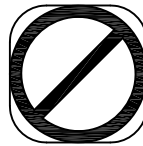

- Avoid installing the remote control in the following areas and/or conditions:
 - areas exposed to heat.
 - areas exposed to steam.
 - areas exposed to oil.
 - areas exposed to direct sunlight.
 - areas near stored or used flammable products.
- Place remote control out of children's reach.
- The remote control should be installed in a convenient location (e.g., kitchen, laundry room, utility room, or directly next to the water heater).
- The maximum distance between the water heater and the remote control installation location is limited to 195 ft. (59 m) of wire.

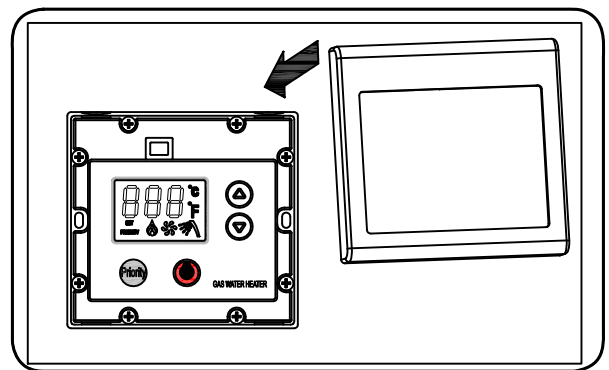

Electrical

INSTALLATION INSTRUCTIONS

Remote Control Installation

⚠ WARNING: Field wiring connections and electrical grounding must comply with local codes or, in the absence of local codes, with the latest edition of the National Electrical Code, ANSI/NFPA 70.

NOTICES:

- Remote control cable can be any Type-T 18 AWG wire similar to a thermostat wire and need not be polarity sensitive.
- It is not recommended to have wiring exposed.
- DO NOT apply sealant to remote control cable.
- DO NOT use network cable, telephone wire, or any twisted-pair cable.

Connecting the Remote Control to a Wall:

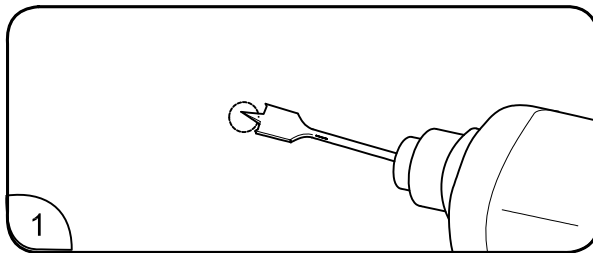

Drill a 1-to 1 1/2-in. (2.5/3.8-cm) hole at the proposed control location. Install the remote control cable between the location of the remote control and the water heater.

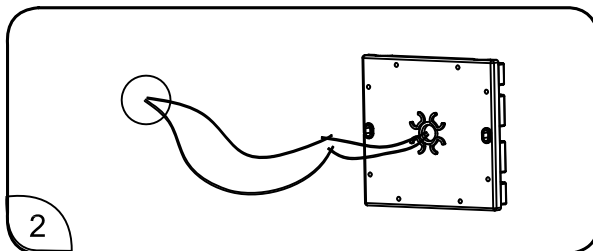

Connect the remote control to the remote control cable.

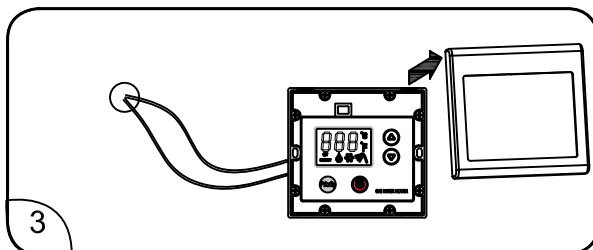

Remove the remote control from the base plate.

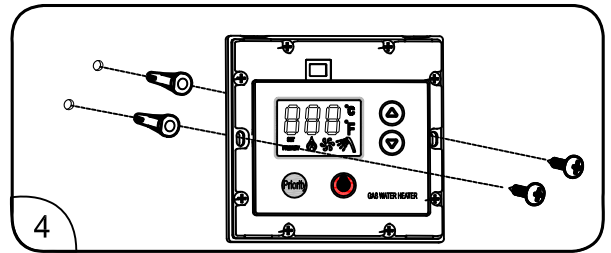

Install the base plate to the wall using suitable screws and wall anchors.

NOTICE: The tabs on the base plate should always point out.

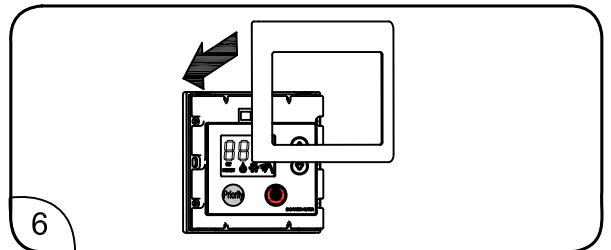

Position the remote control on the base plate.

NOTICE: The tabs on the base plate should line up with the slots on the back of the remote control.

Secure the remote control to the base plate with one screw into the bottom tab.

NOTICE: DO NOT attempt to connect the remote control or control wire to the water heater while the water heater has power applied to it. Damage to the water heater will occur. DO NOT cut or strip the wiring while it is connected to the water heater or while the water heater has power applied to it.

INSTALLATION INSTRUCTIONS



Electrical Wiring (cont.)

Connecting the Remote Control to the Water Heater:

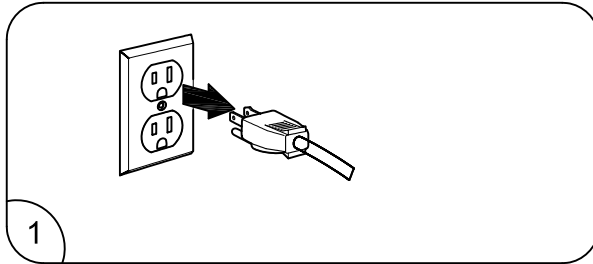

Ensure that the power to the water heater has been disconnected.

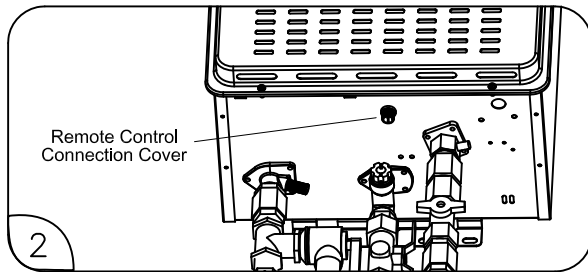

Loosen the one screw located on the remote control connection cover. The connection cover is made of black plastic.

NOTICE: DO NOT REMOVE FRONT PANEL. Remote control wires are connected on the bottom of the unit.

There are NO accessible remote control terminals inside the water heater.

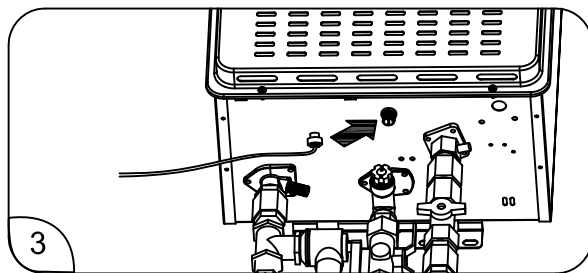

Connect the remote control extension cables from the remote control to the remote control connection terminals.

NOTICE: The remote control wire connection terminals are not polarity-sensitive.

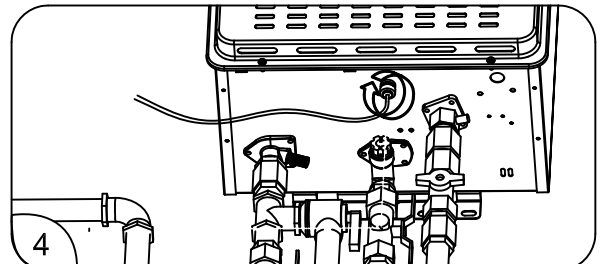

Firmly tighten the terminal screws by hand.

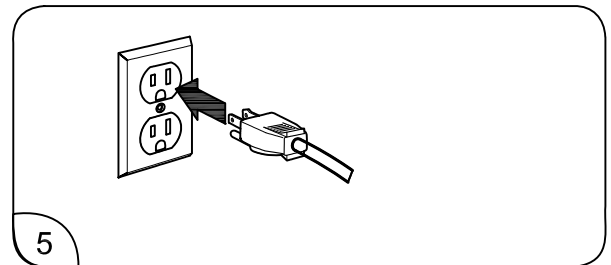

Switch on the power supply to the water heater. Check for proper operation of the remote control and the water heater.

INSTALLATION INSTRUCTIONS



Insulation Blankets

In general, insulation blankets for external use on gas water heaters are not necessary. The purpose of an insulation blanket is to reduce the standby heat loss from the water heater's storage tank. Since these water heaters do not store water, they eliminate the need for the insulation blanket.

The manufacturer's warranty does not cover any damage or defect caused by insulation, insulation attachment, or use of any type of energy-saving or other unapproved devices (unless authorized by the

manufacturer). The use of unauthorized energy-saving devices can result in death, personal injury, and/or property damage. The manufacturer disclaims any responsibility for such loss or injury resulting from the use of such unauthorized devices.



Installation Precautions

- Follow all installation instructions covered in this manual.
- Check the inlet gas pressure to make sure it is within the range specified on the rating plate.
- Make sure there is adequate air for combustion and ventilation as described on pages 40-41 or page 47 in this manual.
- Maintain proper clearances to combustibles and noncombustibles as specified on the rating plate.
- Make sure the venting system complies with local codes, National Fuel Gas Code (ANSI Z223.1/NFPA 54).
- Make sure the heater and remote control are properly fastened to their mounting surfaces.
- Make sure the heater and remote control are wired in accordance with all regulations and codes without any exposed connections.
- Contact the local gas company to make sure the gas meter and gas piping are adequately sized.
- Use only Teflon tape on all male water line connections and fittings.
- DO NOT block or restrict any outside air intake openings.
- DO NOT remove the front cover unless absolutely necessary. This should only be done by a qualified service technician.
- DO NOT install this product where standing water may occur.
- DO NOT use pipe dope on water line connections and fittings.
- DO NOT use Teflon tape on gas line connections and fittings in US.

INSTALLATION INSTRUCTIONS



Installation Checklist

A. Water Heater Location

- Indoor water heaters must be installed indoors.
- Outdoor water heaters must be installed outdoors.
- Close to area of ventilation termination (indoor models).
- Protected from freezing temperatures.
- Proper clearance from combustible material observed.
- Sufficient fresh air supply for proper operation of water heater.
- Air supply free of corrosive elements and flammable vapors.
- Provisions made to protect area from water damage.
- Sufficient room to service heater.
- Combustible materials, such as clothing, cleaning materials, and rags clear of the heater and vent piping.
- Water heater is properly secured to the wall.

B. Vent (Indoor Models)

- Vent pipe material is ULC S636 approved and manufacturer-approved.
- Horizontal air intake pipe and exhaust pipe have a 1/4" per foot UPWARD slope toward the vent terminal.
- Connection(s) securely fastened together with cement and airtight.
- All vent runs are properly installed.
- Vent terminal is properly installed.
- Maximum vent length is observed.

C. Water Supply/Relief Valve

- Water supply has sufficient pressure.
- Air has been purged from the water heater and the piping.
- Water connections tight and free from leaks.
- Water filter is clean and in place.
- Water pipes are insulated and protected from freezing, if necessary.
- Pressure-relief valve properly installed with discharge line running to open drain.
- Discharge line protected from freezing, if necessary.

D. Gas Supply

- Gas type matches listing on rating plate.
- Gas supply pressure is sufficient for the water heater.
- Gas line equipped with shut-off valve, union and sediment trap as described on page 45.
- Approved pipe-joint compound has been used on all gas pipe connections.
- All connections and fittings have been checked for leaks with a soapy water solution.
- Gas company inspected installation (if required).

E. Electrical Wiring

- Supply cord and/or wiring meets all local codes, National Electrical Code, ANSI/NFPA 70, in the U.S.
- Voltage matches listing on rating plate.
- Water heater is properly grounded.

INSTALLATION INSTRUCTIONS



Activating the Water Heater

⚠️ WARNING: Before operating this water heater be sure to read and follow the instructions on the following label, all labels on the water heater, and the "Important Safety Information" section in this manual. Failure to do so can result in unsafe operating conditions that can result in death, personal injury, property damage, and/or product damage.

FOR YOUR SAFETY READ BEFORE OPERATING

WARNING: If you do not follow these instructions exactly, a fire or explosion may result causing property damage, personal injury or death.

- A. This appliance does not have a pilot light. It is equipped with an ignition device which automatically lights the burner. Do not try to light the burner by hand.
- B. **BEFORE OPERATING** smell all around the appliance area for gas. Be sure to smell next to the floor because some gas is heavier than air and will settle on the floor.
WHAT TO DO IF YOU SMELL GAS
 - Do not try to light any appliance.
 - Do not touch any electric switch; do not use any phone in your building.
 - Immediately call your gas supplier from a neighbor's phone. Follow the gas supplier's instructions.
 - If you cannot reach your gas supplier or fire department, do not return to your home until authorized by the gas supplier or fire department.
- C. Use only your hand to push in or turn the gas control knob. Never use tools. If the knob will not be pushed in or turned by hand, don't try to repair it, call a qualified service technician. Force or attempted repair may result in a fire or explosion.
- D. Do not use this appliance if any part has been under water. Immediately call a qualified service technician to inspect the appliance and to replace any part of the control system and any gas control which has been under water.

OPERATING INSTRUCTIONS

1. **STOP!** Read the safety information above on this label
2. Turn off all electric power to the appliance.
3. Do not attempt to light the burner by hand.
4. Turn the Gas Shutoff Valve located on the outside of the unit clockwise ↻ to the "OFF" position.
5. Wait five(5) minutes to clear out any gas. If you then smell gas, **STOP!** Follow "B" in the safety information above on this label. If you don't smell gas, go to the next step.
6. Turn the Gas Shutoff Valve located on the outside of the unit counterclockwise ↻ to the "ON" position.
7. Turn on all electric power to the appliance.
8. If the appliance will not operate, follow the instructions "To Turn Off Gas To Appliance" and call your service technician or gas supplier.

GAS SHUT OFF
VALVE



OPEN



CLOSE

TO TURN OFF GAS TO APPLIANCE

1. Turn off all electric power to the appliance if service is to be performed.
2. Turn the Gas shutoff Valve located on the outside of the unit clockwise ↻ to the "OFF" position.

INSTALLATION INSTRUCTIONS

Activating the Water Heater

Operating Instructions

Read, understand, and follow the safety information listed on the operating label on page 52 and in the "Important Safety Information" section on pages 2-8 in this manual.

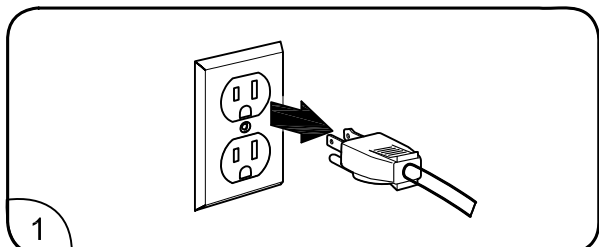

Disconnect all electric power to the water heater.

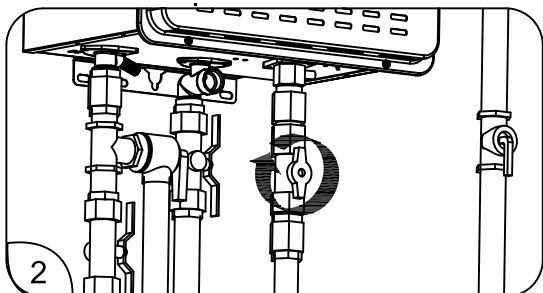

Turn the gas shut-off valve clockwise to the OFF position. This valve is located on the outside of the water heater. Wait 5 minutes to clear any gas. If you don't smell gas, proceed to Step 3.

NOTICE: If you smell gas, STOP and follow the safety instructions listed under B on the operating label or on the front cover of this manual.

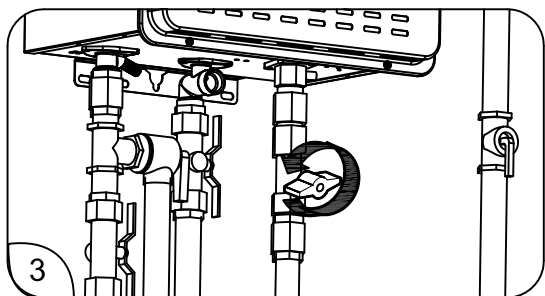

Turn the gas shut-off valve counterclockwise to the ON position.

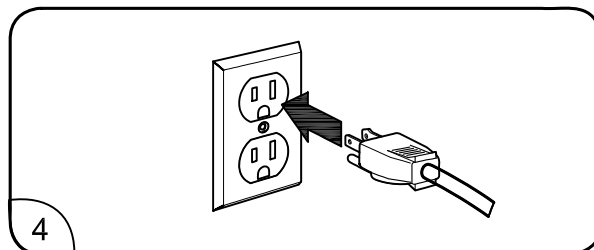

Turn on all electric power to the water heater. The water heater burner will automatically light when there is a demand for hot water.

⚠ WARNING: DO NOT attempt to light the burner by hand. Lighting the burner by hand is an unsafe operating condition that can result in death, personal injury, property damage, and/or product damage.

If the water heater burner will not light, turn off the water heater as described below and call your service technician or gas supplier.

Shutting Off the Water Heater

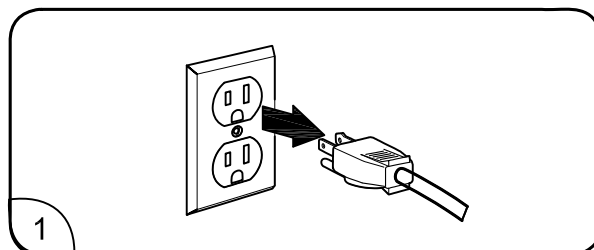

Disconnect all electric power to the water heater.

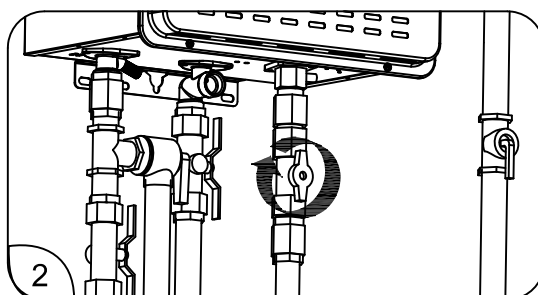

Turn the gas shut-off valve clockwise to the OFF position.

INSTALLATION INSTRUCTIONS

The contents on pages 54 through 55 should only be performed by qualified service personnel.

Setting the Water Temperature

WARNING: Improper adjustment, alteration, service, or maintenance can result in death, personal injury, property damage, and/or product damage.

DANGER: Water temperatures above 125°F (52°C) will result in death and/or severe burns from scalding.

WARNING: Refer to chart below and the scald potential warnings on page 4 on this manual before making an adjustment. Changing this setting is done at your own risk.

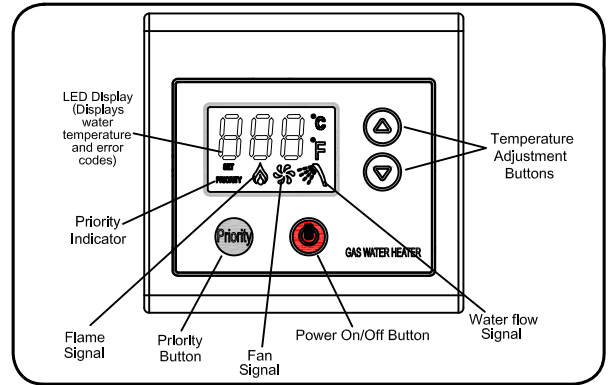

Control panel

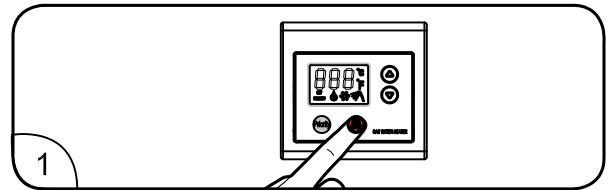

1 Turn on the remote control.

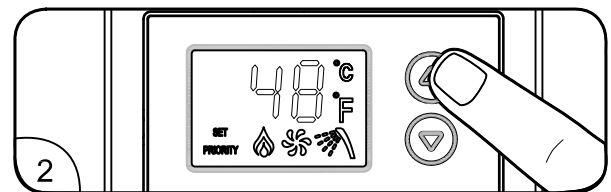

2 Press the UP or DOWN button to set the expected temperature.

Available temperature
99°F(37°C)-140°F(60°C).

If the expected temperature range is 118°F(48°C), adjust the temperature with $\pm 1.8^\circ\text{F}$ ($\pm 1^\circ\text{C}$) by every pressing on the buttons; if the expected temperature is over 118°F(48°C), the temperature can be set according to the following range:

118°F(48°C)-122°F(50°C)-131°F(55°C)-140°F(60°C) ,

NOTICE: LED display only shows °F.

Time/Temperature Relationship in Scalds

Water Temperature	Time to Produce a Serious Burn
120°F(49°C)	More than minutes
122°F(50°C)	1 1/2 to 2 minutes
131°F(55°C)	About 30 seconds
135°F(57°C)	About 10 seconds
140°F(60°C)	Less than 5 seconds
145°F(63°C)	Less than 3 seconds
150°F(66°C)	About 1 1/2 seconds
155°F(68°C)	About 1 second

Table courtesy of Shriners Burn Institute

Residential water heater temperature can be adjusted up to 140°F(60°C). DO NOT perform the following adjustment if a setting of up to 140°F(60°C) is not required.

Table courtesy of Shriners Burn Institute

Temperature Conversion Chart °F/°C	
99	37
100	38
102	39
104	40
106	41
108	42
110	43
112	44
114	46
116	47
118	48
122	50
131	55
140	60

INSTALLATION INSTRUCTIONS



Setting the Water Temperature (cont.)

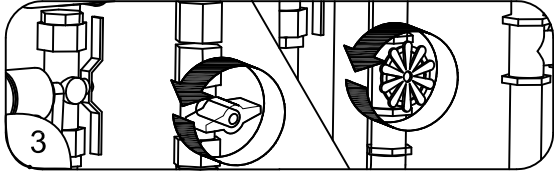

After setting temperature, switch on the gas valve and the water inlet valve, then you can operate the water heater.

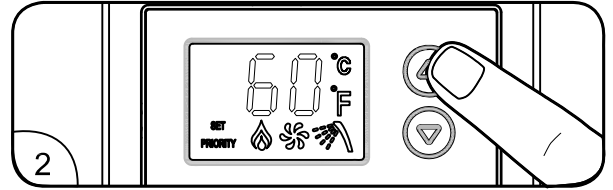

Press the UP or DOWN button to set the expected temperature between 118°F(48°C) and 122°F(50°C).

NOTICE: If the water heater is working, the temperature can be set arbitrating in range of 99°F(37°C)-118°F(48°C). You can only set the temperature over 118°F(48°C) after switching off the water valve by Pressing UP button.

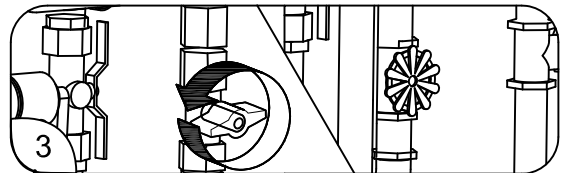

After setting temperature, switch on the water valve, then you can operate the water heater.

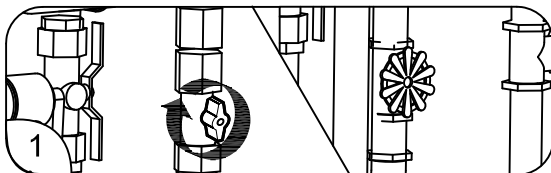

Switch off the water valve.

PARTS REPLACEMENT



Parts Ordering

⚠️WARNING: For your safety, DO NOT attempt to disassemble, repair, or replace any portion of this unit. Refer all repairs, service, and/or adjustments to qualified service personnel.

Address all parts orders to the distributor or store where the water heater was purchased. All parts orders should include:

1. The model and serial number of the water heater from the rating plate.
2. Specify the gas type (natural or LP) as marked on the rating plate.
3. Parts description (as shown below) and number of parts desired.

Outdoor Gas Components(180,000BTU/hr--GA26ONG/LP) (150,000BTU/hr--GA22ONG/LP)

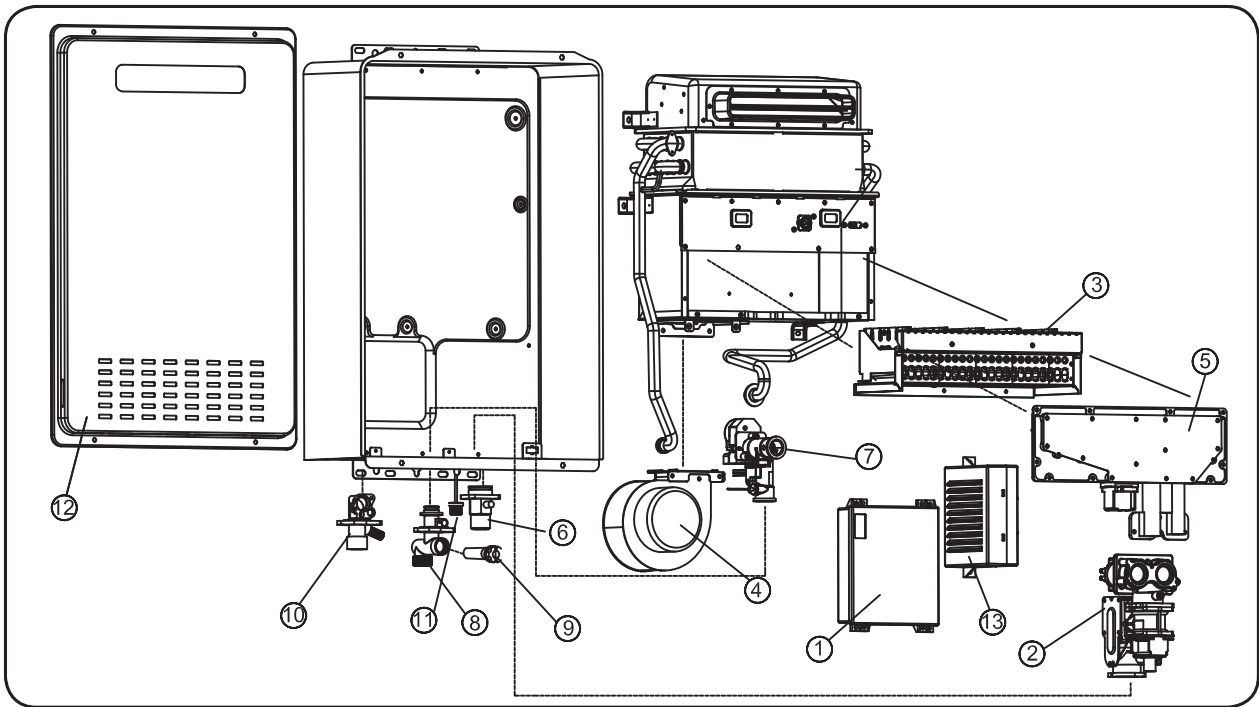

Ref #	Description
1	Control Board
2	Gas Valve
3	Burner Assembly
4	Blower Motor
5	Burner Manifold
6	Gas Inlet Connector 3/4"
7	Water Control Body
8	Water Inlet Connector 3/4"
9	Inlet Water Filter
10	Hot Outlet Connector
11	Remote Control Terminal Block
12	Front Cover
13	Power Box

PARTS REPLACEMENT

Parts Ordering (cont.)

Outdoor Gas Components (199,000BTU/hr--GA30ONG/LP)

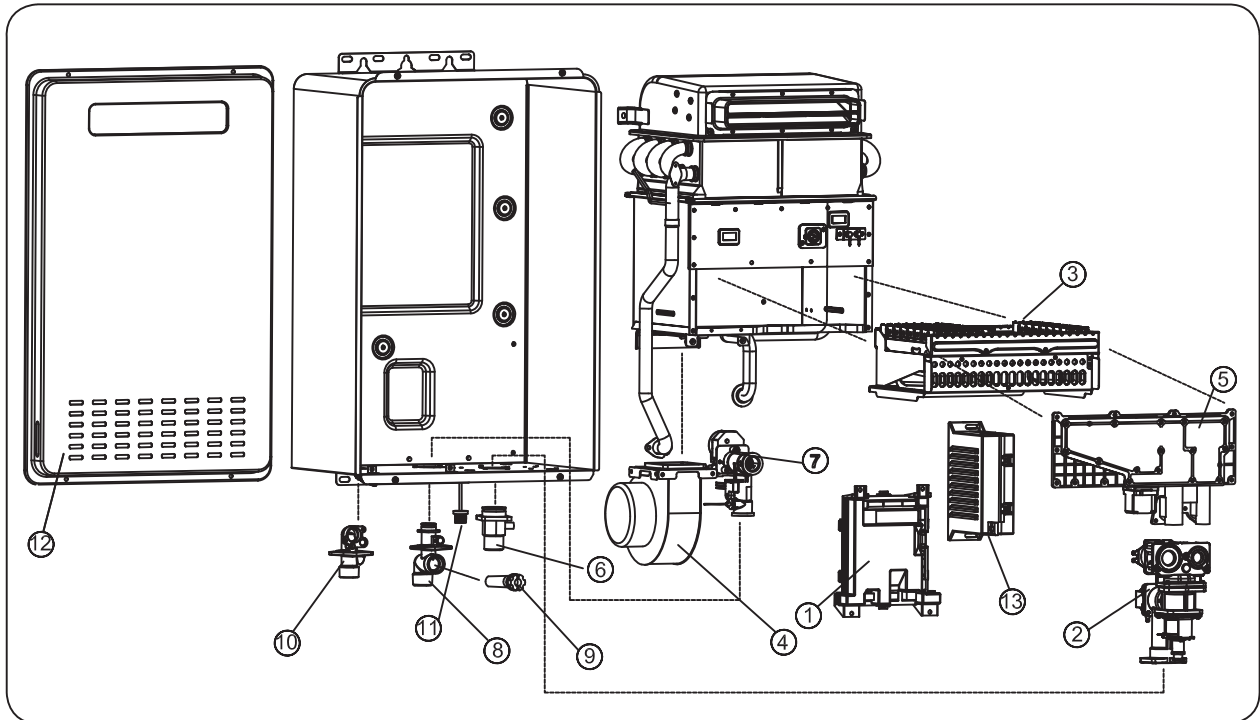

Ref #	Description
1	Control Board
2	Gas Valve
3	Burner Assembly
4	Blower Motor
5	Burner Manifold
6	Gas Inlet Connector 3/4"
7	Water Control Body
8	Water Inlet Connector 3/4"
9	Inlet Water Filter
10	Hot Outlet Connector
11	Remote Control Terminal Block
12	Front Cover
13	Power Box