

# ShelterIt™

## 12'x24'x8' Instant Shelter

### INSTRUCTION MANUAL

**# 71224**



### **Parts Alert!**

If you have a question or if there are missing parts, please call:

**203-591-9032**

or email **Service@shelterit.com**

Monday-Friday 9:00am-5:00 p.m. EST

Missing parts will be sent to you via courier.

Visit [ShelterIt.com](http://ShelterIt.com) for instructional video

**DO NOT RETURN TO STORE!**

**Please read instructions fully before beginning assembly!**

**Visit [Shelterit.com](http://Shelterit.com) for installation Video**

# TABLE OF CONTENTS

SAFETY CAUTIONS.....	3
PARTS LIST.....	4
ASSEMBLY INSTRUCTIONS.....	5-17
LIMITED WARRANTY.....	18

## SAFETY and PRE-ASSEMBLY CAUTIONS

### READ PRIOR TO ASSEMBLY!

DO NOT ASSEMBLE OR DISASSEMBLE THE STRUCTURE ON A WINDY DAY. ONCE ASSEMBLED, IF HIGH WINDS ARE FORECASTED WE RECOMMEND YOU TO REMOVE THE COVER AND STORE UNTIL THE WINDY CONDITIONS HAVE PASSED.

### WARNING!

1. The cover is made of 3-layer polyethylene. Please do not use open flames and heated elements inside or in close proximity to the product (including all types of stoves, gas heaters, gas lanterns, citronella torches, mosquito coils, etc.). The fabric will burn if left in continuous contact with a flame or heat source. Any damage to the cover as a result of using open flames or heating elements will void the Manufacturer's warranty.
2. This is a temporary structure and is not recommended for use as a permanent structure.
3. Choose your shelter's location carefully. Check for overhead utility lines, branches, etc. Do NOT install near roofs or other structures that may shed snow or ice onto the shelter.
4. Inventory all parts before attempting installation.
5. Always wear safety glasses and gloves when assembling or disassembling this product.
6. The shelter must be installed on a level surface.
7. Anchors must be used with all shelters. When erecting shelters, covers should NOT be installed on any product until it has been properly anchored to the ground. Any shelter that is not anchored securely or properly will blow away. Proper anchoring of the shelter and suitable soil conditions are the responsibility of the customer.
8. Never start gas engines from any vehicle or other machinery within a closed shelter. Special ventilation including an open door should be used at all times for these situations. Any work with paints, cleaning products, etc, may require additional ventilation. When possible always avoid working with such chemicals inside the shelter.

9. Do NOT use barbeque grills, smokers or other flammable equipment under or inside any shelter.
10. Do not cook, smoke, use flammable devices, refuel or store flammable materials in this shelter. Never use or ignite an open flame in the shelter. Open flames must be kept a safe distance away from the shelter.
11. No snow accumulation should be allowed on the shelter. Monitor continuously for accumulated snow on the roof. Snow or ice accumulation may cause your shelter to collapse. This shelter is NOT designed to hold heavy snow or ice loads. Brush snow and ice off the roof top with a broom or mop. Failure to remove snow will void the Manufacturer's warranty.
12. Never clear the roof of snow or debris from inside the shelter. Doing so will increase the risk of collapse, damage to property, personal injury and/or death.
13. Municipal by-laws must be verified prior to setting up this temporary shelter.

#### **CARE & CLEANING**

1. After assembly, periodically check the anchors, the tension of ratchets, buckles and all hardware to ensure the stability of the shelter. Especially during the first few weeks it will be necessary to tighten the cover and hardware. Always ensure that all covers and hardware are kept tightened.
2. Do NOT apply any "Protect & Shine" type products to the cover or other harsh abrasives including bleach or cleansers. The cover can be easily cleaned with mild soap and water. If storing the cover after cleaning, allow it to fully dry prior to storage.
3. Do NOT use the product for purposes or in an environment for which it is not intended, (e.g. extreme cold, high wind conditions, extreme heat, heavy rainfall, etc.).

**Please note that the Manufacturer has no control over the elements such as wind, heavy snow or rain. The Manufacturer cannot control the location or soil conditions into which the shelter is placed. The Manufacturer, without control of the elements, location or soil conditions, cannot be held responsible for damages caused by the shelter to other items or damages to the shelter itself.**

## **ASSEMBLY**

*Please read instructions fully before beginning assembly.*

### **Step 1: Checking the Parts**

Unpack and check the contents of the box. Make sure that you have all the parts described in the parts list shown hereafter.

























**If parts are missing, please contact customer service: 203-591-9032. Missing parts will be sent courier to you.**

**Do not return this product to the store!**

**Visit [Shelterit.com](http://Shelterit.com) for installation Video**

# PARTS LIST

## 12x24x8

Part #	Description	Drawing	Qty
12241	#2 4-way Peak Connector		5
12242	#1 3-way Peak Connector		2
12243	#3 Rafter Pole		14
12244	#4 Side Connector		14
12245	#5 Upright Pole1		4
12246	#6 Bend Corner Leg		4
12247	#7 Upright Pole2		10
10206	#8 Steel Foot Plate		10
12249	#9 Top Cross Rail		6
122410	#10 Side Cross Rail-s		10
122411	#11 Side Cross Rail		2
122412	#12 Bottom cross rail		12
102018	#14 Steel Rod for Win Brace		4
122420	#15 Steel Rod for middle rib		5
102021	Wire Cable 1'		4
102022	Cable Clamp		4
102023	Removable 15" Auger Anchor		4
102024	4-Way Cover Rail Clamp		20
102025	3-Way Cover Rail Clamp		8
B675	Bolt 3"	M6x75mm	14+1
B645	Bolt 2"	M6x45mm	106+1
N6	Nut	M6	120+2
M6	Washer	M6	8+1
S620	"S" Hook		4
E635	Eye Bolt with Nut		4
9913724	Roof Cover		1
2213724	Front Door Panel (with Zipper)		1
2413724	Back Panel		1
	Owner's Manual		1

# Assembling the Frame

Visit [Shelterit.com](http://Shelterit.com) for installation Video

Diagram A below represents the completed Frame Assembly once steps 1- 4 are completed.

**Note: 2 or more people are required for safe and accurate assembly.**

When assembling the frame **HAND TIGHTEN** the bolts for the cross rails where the Square are located in Diagram A.

When putting the cover and doors on, they will need to be temporarily removed and retightened.

12x24x8

**A**

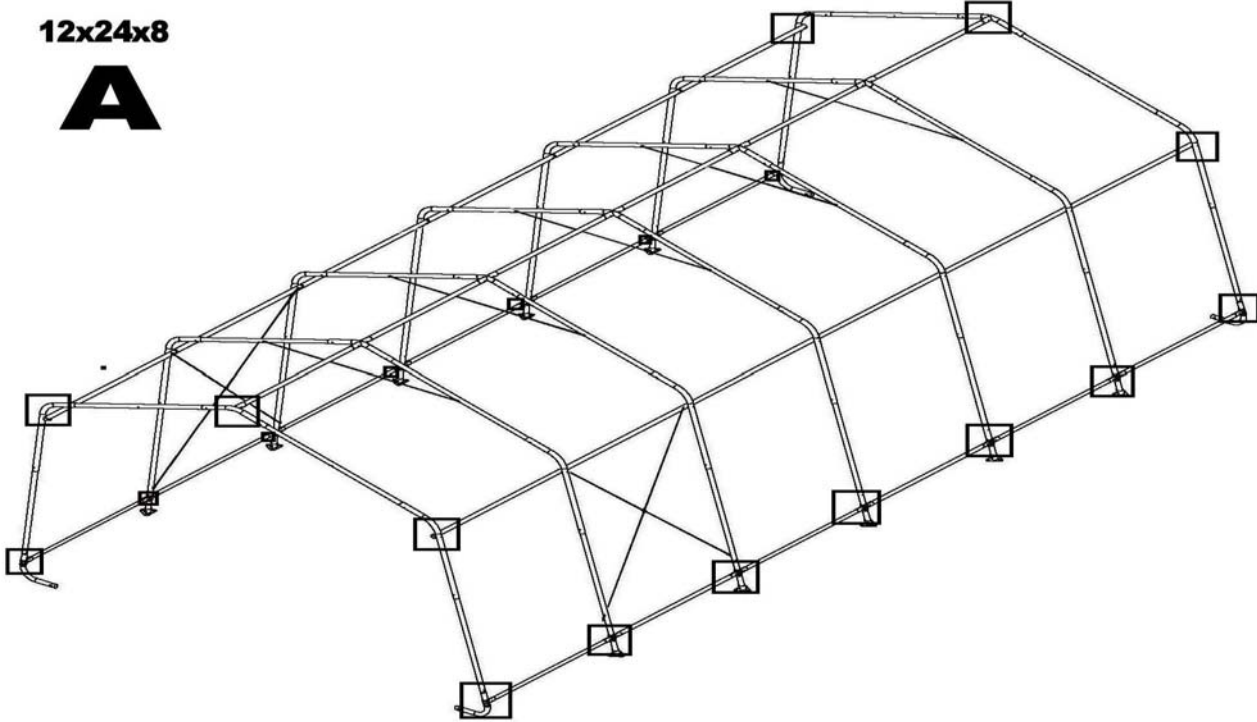

**B**

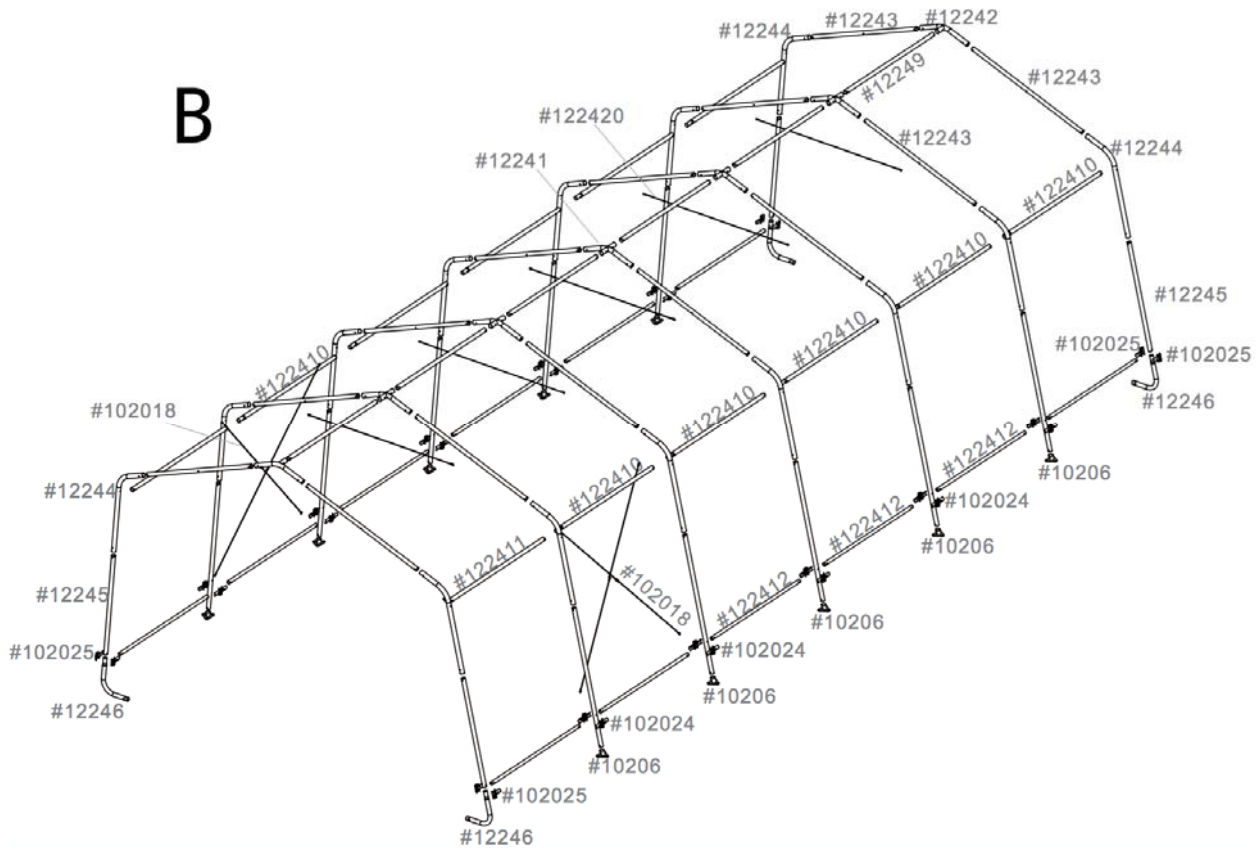

## Step 1 – Collect your Tools

### Tools required to assemble the shelter include:

- Safety Glasses – 1-pair per participant
- 1-Adjustable wrench or box wrench
- 1-Rubber mallet (to be used to ensure all pipes are fully inserted)
- 1-Step stool or ladder – shelter is 8' tall
- 1-Hammer to set bolts

Some of the tubes are manufactured with square small dents on one end to act as pressure points to insure the tube fit snug.

Assembly Tip: Using a hammer, tap the bolts to wedge them slightly into the opening. When tightening the self-locking nuts, ensure to draw the bolt heads into the holes of the pipe so that the head of the bolt when fully tightened is flush with the pipe. Failure to do so may cause bolts to tear the shelter's cover.

## Step 2: Assembling the Roof Visit Shelterit.com for installation Video

Layout the roof parts as shown in **Diagram C**. Look at B above for the part #s

Connect all parts as shown in **Diagram C** to form the peak of the shelter frame. Use 2" bolts and nuts to assemble the roof and the center truss brace rods together. Put the truss rod on the round head side of the bolt when connecting to the frame see **Diagram F**.

Install all carriage bolts with nuts facing into the center, inside of the frame to insure the cover does not tear

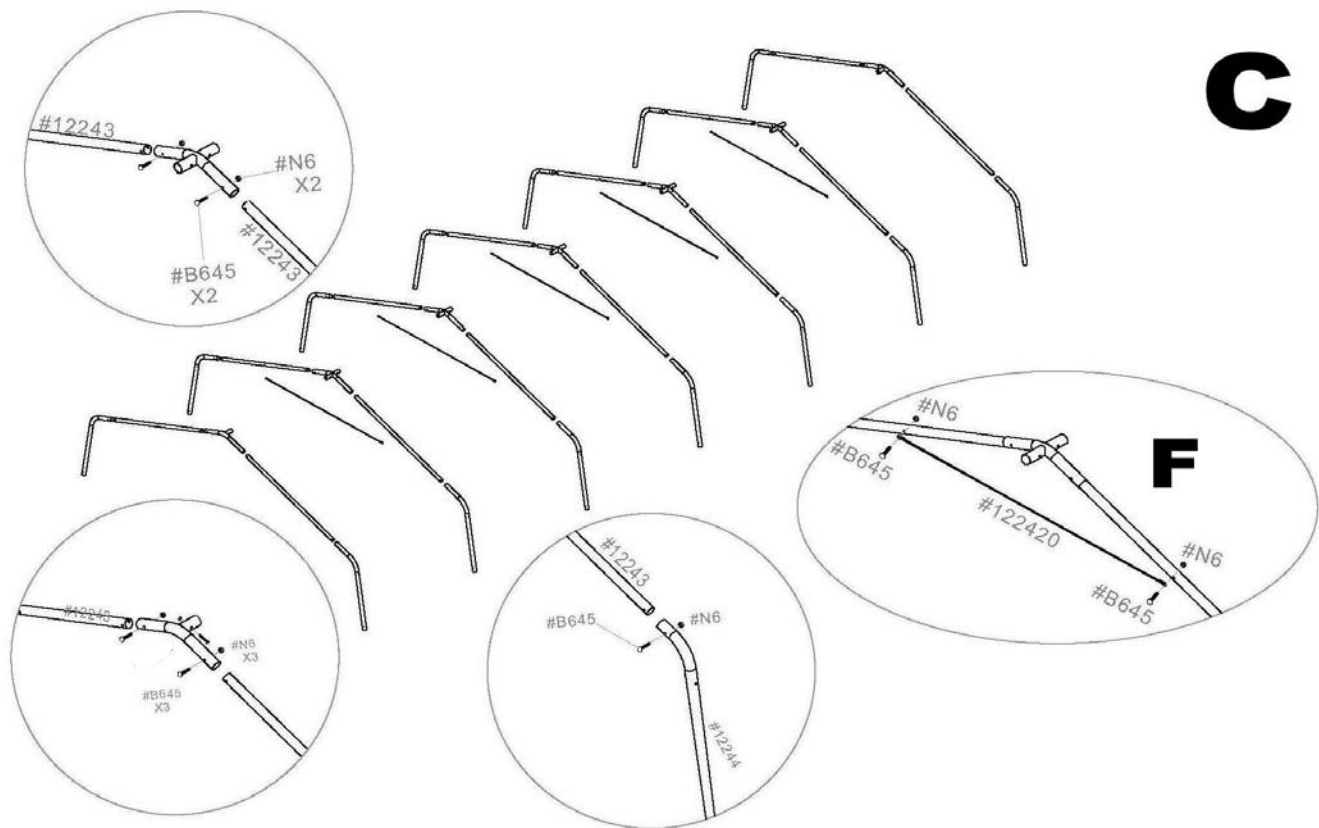

### Step 3: Assembling the Cross rails, Center truss braces and side Structural X braces

Layout the roof parts as shown in **Diagram D** Look at **Diagram B** for the part #s

Connect all cross rails front to back in **Diagram D**.

Use **2"** bolts and nuts to assemble the top cross rails for roof and the truss brace steel rods .

Use the **3"** bolts to connect the **side cross rails** to the side bent tubes.

Hand tighten the nuts that are in **the square box** locations until after the doors are installed and then retighten.

Connect the top part of the X Braces to the inside of the cross rail.

Use a **3"** bolt, washer and nut to connect the X braces.

See **Diagram G**

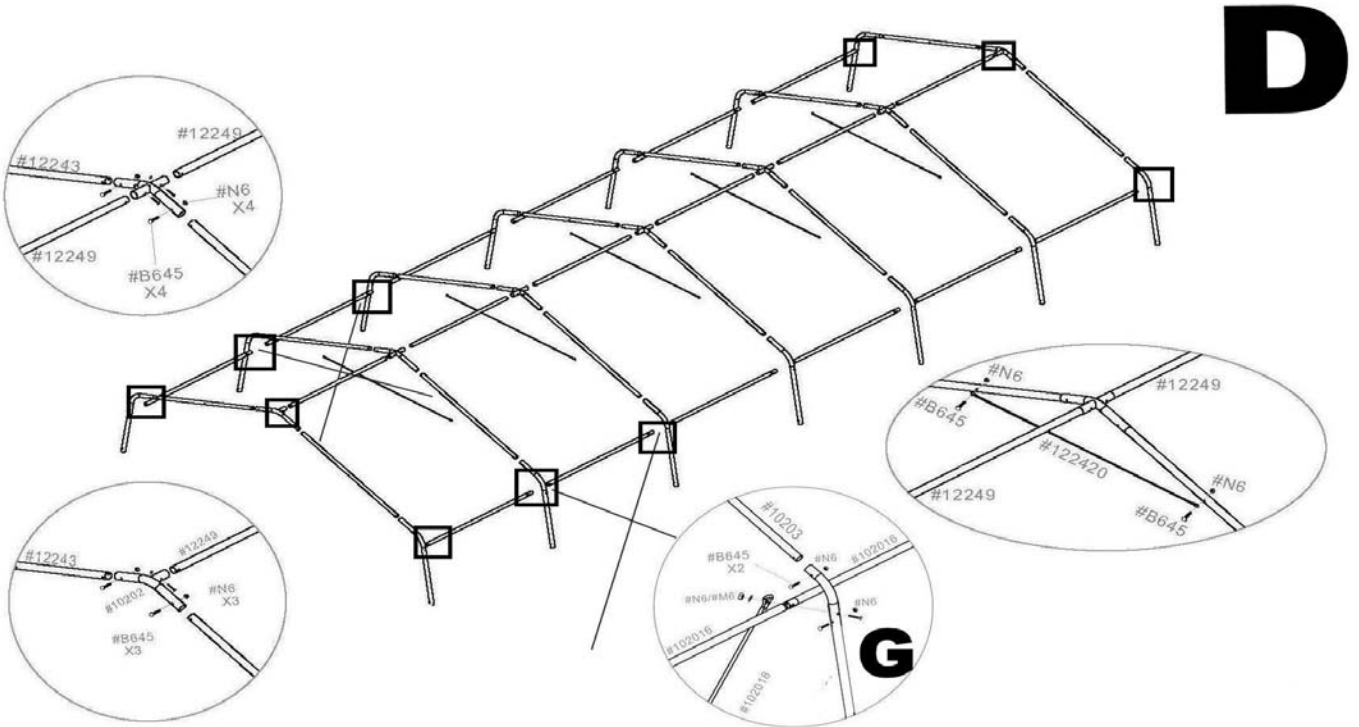

## Step 4: Attaching the upright Legs

- There are four corner legs and 6 middle legs. Assemble the four corner leg tubes for first. Please refer to **Diagram H**.
- Installing the upright legs. This is accomplished by lifting the side of the shelter while the other side remains resting on the ground.
- Have your 2" bolts ready.** Insert the corner legs and center legs as shown in **Diagram E H L**
- Once the legs are assembled, connect the bottom of the **X BRACES** to the upright leg with a 2" bolt and washer with the nuts facing inside See **Diagram L**
- Connect the bottom cross rails and **clamps Hand tight** to the uprights for now. Repeat the process on the other side of the shelter. See **Diagram E H L**
- After the frame is up, install the center steel foot plates to the middle uprights see **Diagram L**.
- We recommend installing the temporary anchors, before installing the cover and doors See **Diagram M** on page 18.

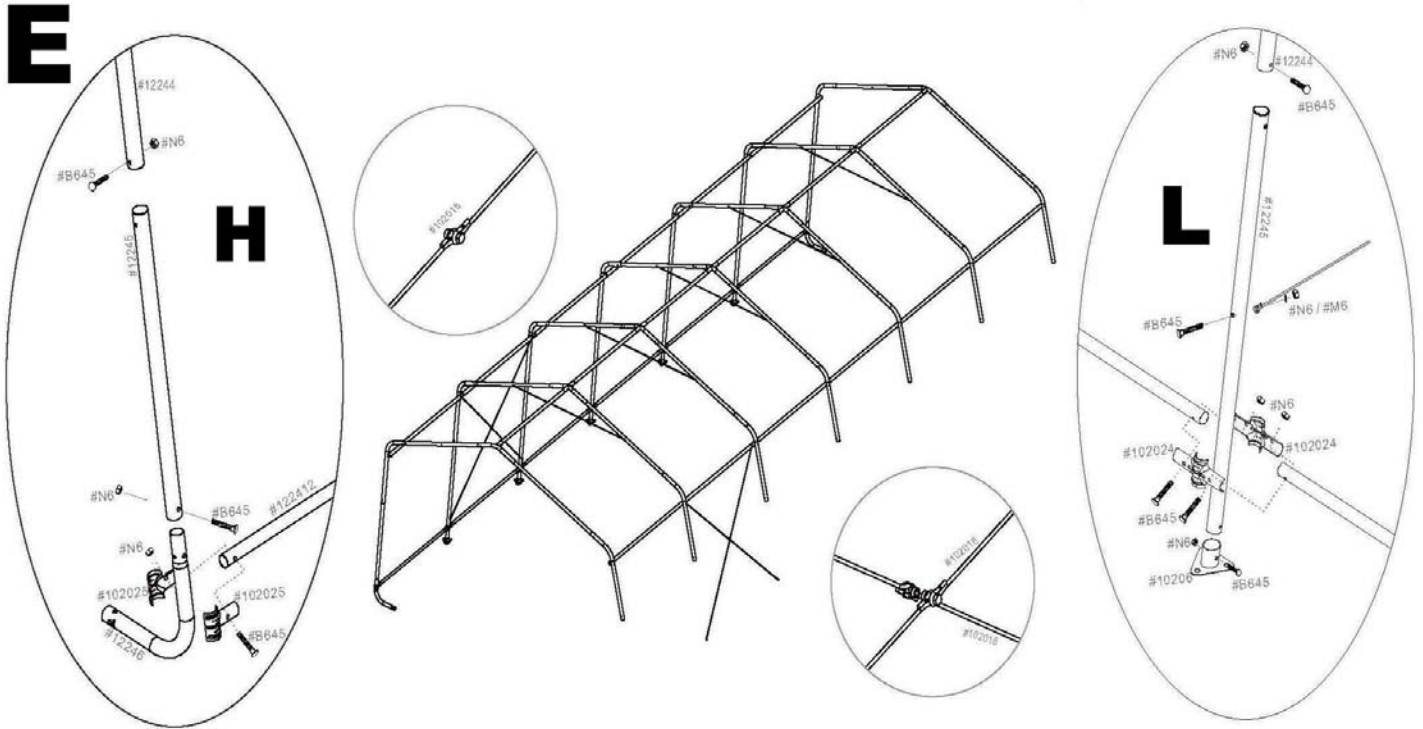

12x24x8

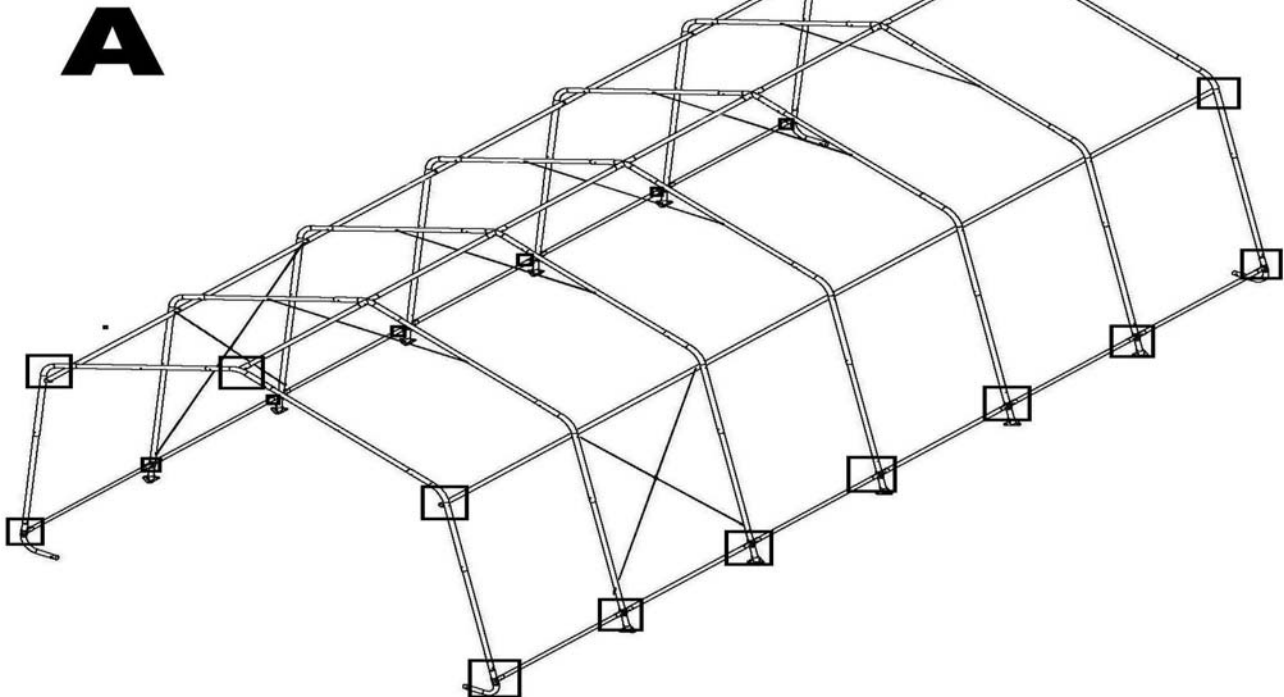



# Step 5. Installing the front and back door panel

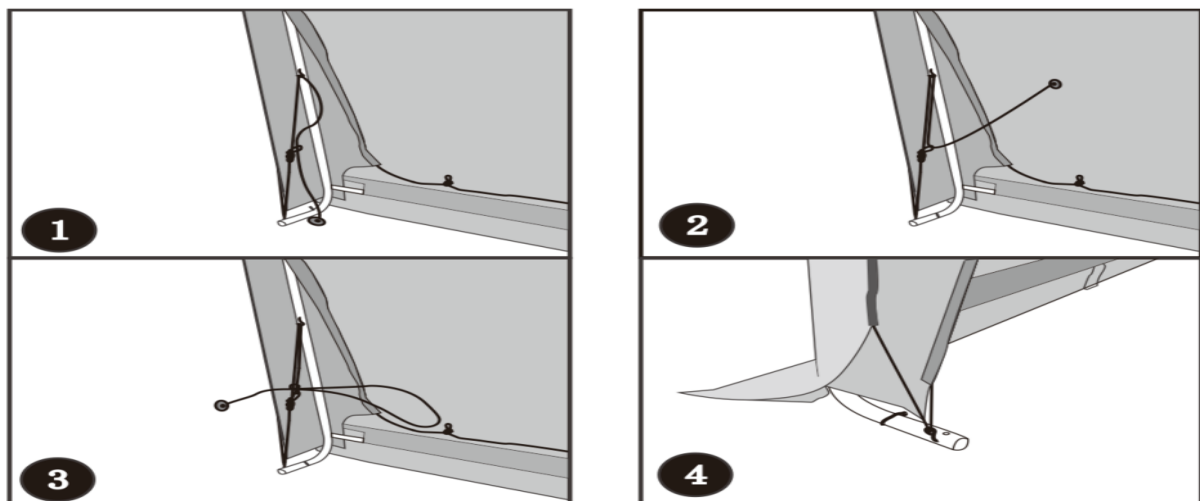
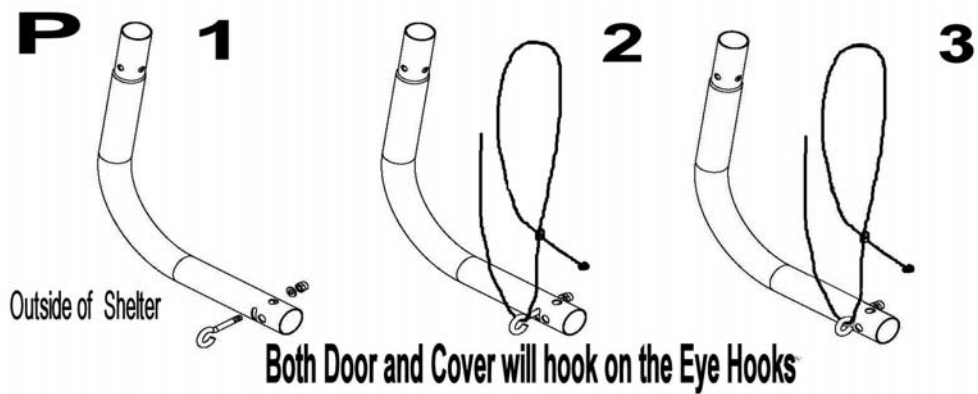
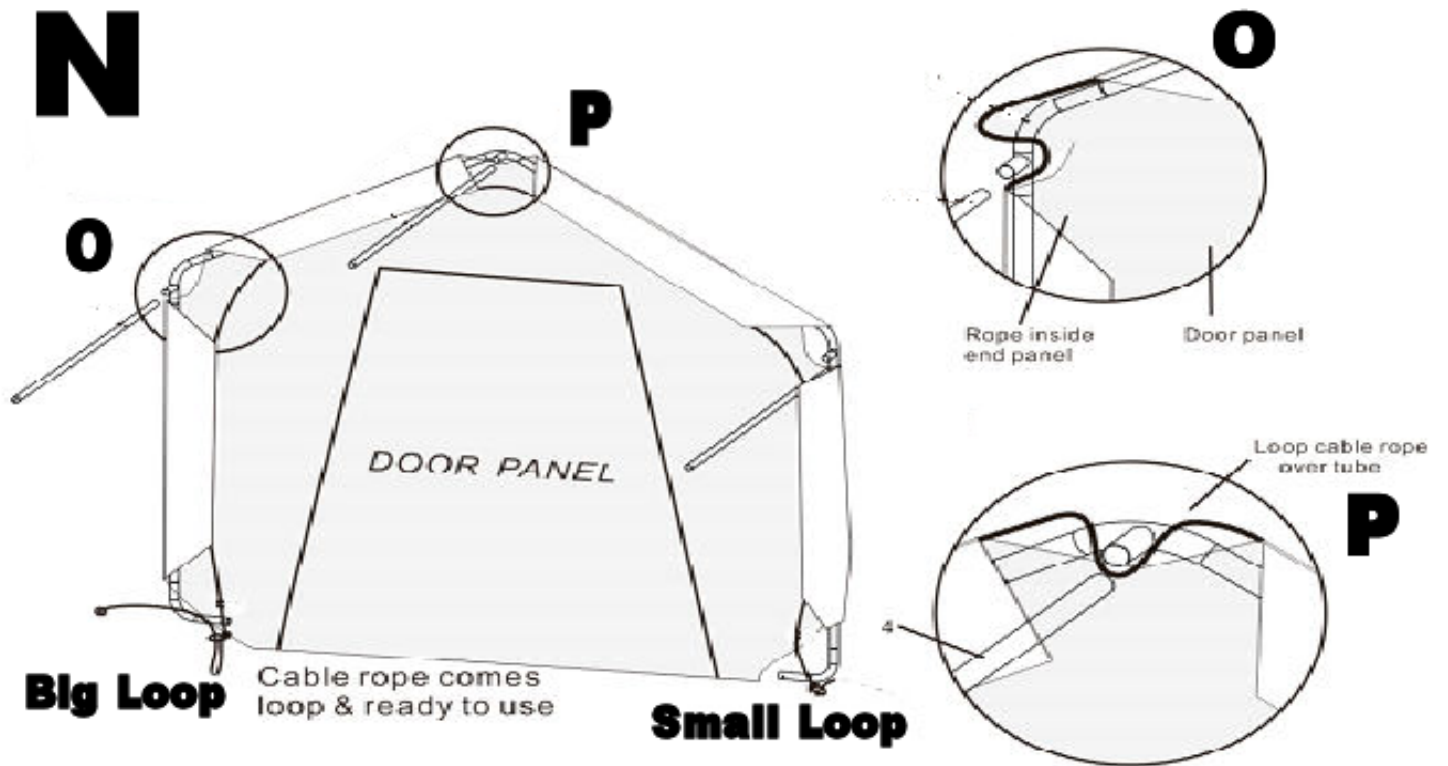

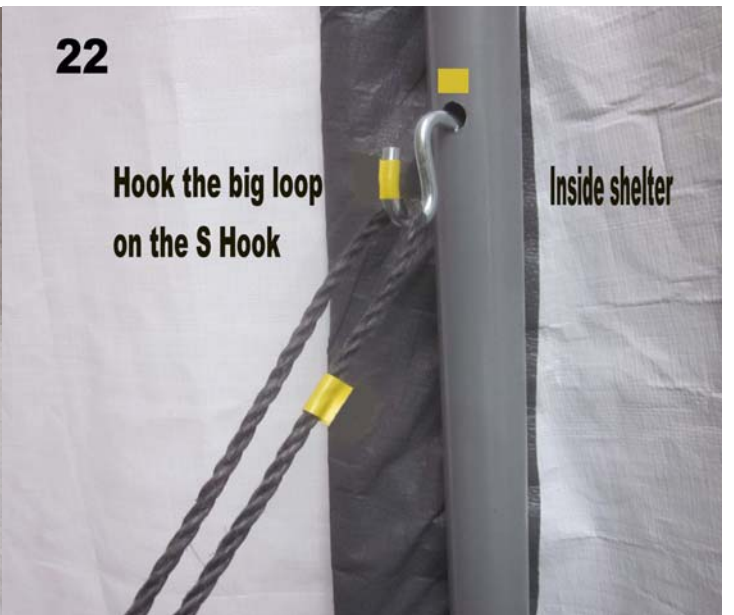
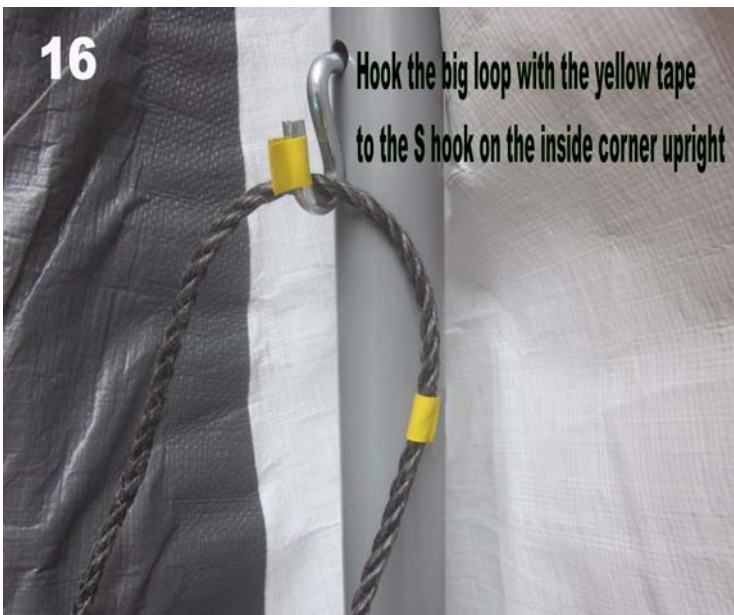
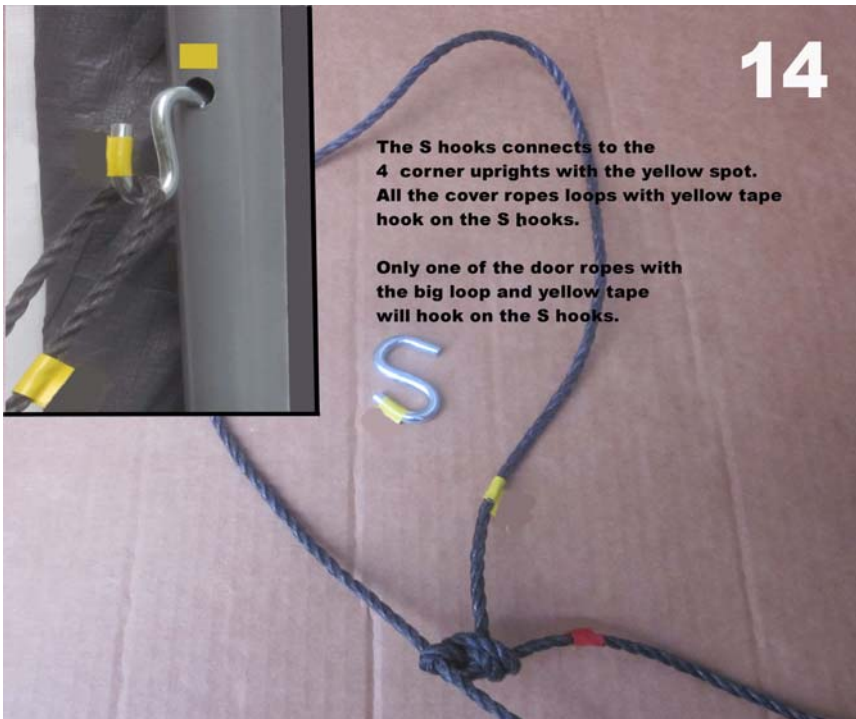
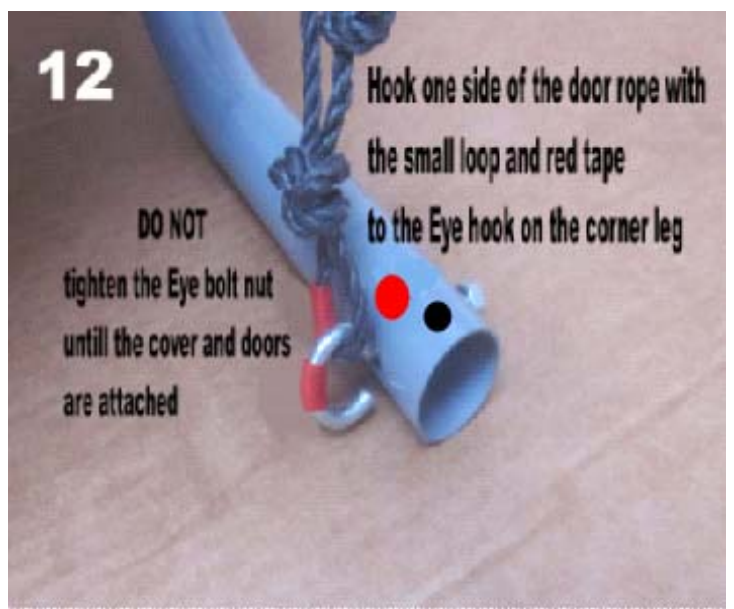
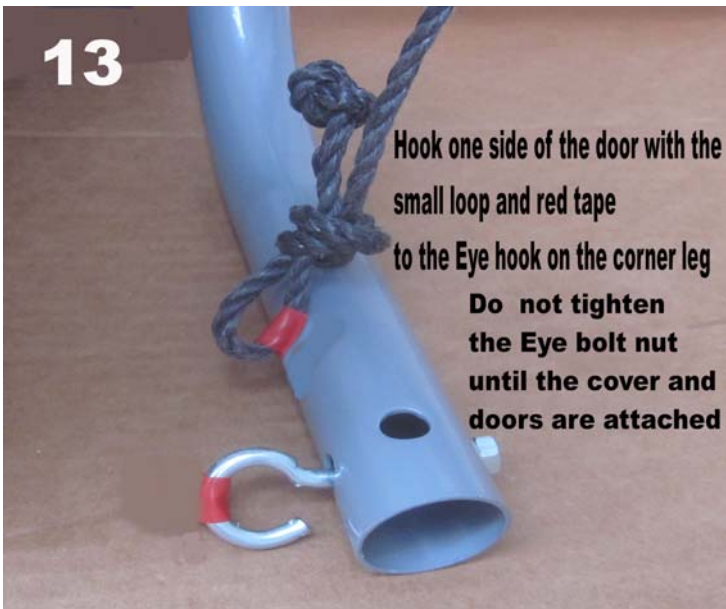

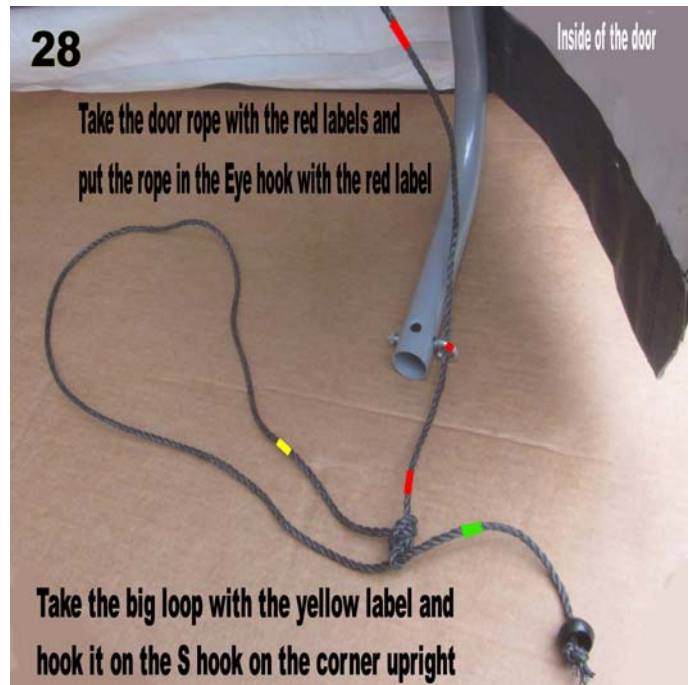



## INSTALLING THE FRONT AND BACK PANEL Visit [Shelterit.com](http://Shelterit.com) for installation Video

Starting from the peak, disconnect the Cross Rail from the 3-way top connector. Place exposed Rope at the top of the panel over the 3-way connector and under the cross pole as shown in **Detail P** above.. At each corner remove the Cross Rail and pull the door fabric around to the inside, placing the 3-way connector through the opening in the fabric as shown in **Detail O**. Reconnect the cross rails.

Find the corner upright with the holes below to the yellow  sticker.

Make sure the hole is facing in.

Insert the S hook with yellow  label in the hole with the Yellow  Label **Detail 17**

On the bent corner leg you will see a red  label next to the hole.

Insert the eye hook with the red  label on it. See **Diagram P**

The Eye hook should be facing the outside of the shelter.

Put the nut and wash on the eye hook on the inside of the shelter, sometimes the washer and nut are preinstalled. The open end of the eye hook should be facing down and leave the nut loose or hand tight enough to hook the door and cover rope into it **Detail P and 13**

There is a large loop and a **small loop** on the rope on each side of the door panels **Detail 13 & 14**

Find the small loop on the door rope with the red  label and hook it into the eye hook with the red  label



Center the door **Detail 12**



The bottom of the door should be just above the eye hook and the bottom corner leg **Detail 23**

Take the rope on the other side of the door that has the big loop.

You will see 2 red  labels on the door rope before the big loop

Hook the rope in the Eye hook with the red  label **Detail 28**

Hook the big loop with the yellow  label on the corner upright S hook with the yellow  label on it **Detail 22**

Take the end of the rope with the green  label and ball and pull up to make the big loop with the yellow  label smaller.

This will tighten the doors to the frame.

After making the door snug **Detail 19 22 & 28**

You can pull all around the inside corners of the door too even the door on the frame.

The bottom of the door should be just above the eye hook and above the bottom corner leg

This will insure the door will not rub on the ground and wear it out **Detail 23.**

Pull up on the rope again so the door is tight on the frame and tie a few knots to secure the rope

Repeat the same for the back panel.

## Step 6. Installing the Covers Visit Shelterit.com for installation Video

Installation Tip: Visually check all pipes of the frame to ensure they are fully inserted into the next pipe before installing cover. Pipes may separate during installation of end covers and prevent proper installation of the main cover



Two people, each positioned approximately one-third into the center of the cover, carefully pull the cover over the frame. When reaching the peak use a step stool or ladder to pass over this height.

Pull the cover over the frame so **the rope in the pocket** is in the front and back of the shelter, not on the side of the shelter.

The 4 corner ropes should be in the 4 corners.

.When the roof tarp is in position **the empty cross rail pockets should be on the side of the shelter near the ground.**

## Step 7: Installing Lower Cross Rails into the main cover

The shelter cover is manufactured with heat-welded pipe pocket sleeves along the lower wall of each side (white color faces inside the shelter,

Disconnect the lower cross rails and clamps and insert the cross rails in the pockets of the cover and reassemble the clamps to the frame hand tight. Both sides of cross rails on the shelter should be approximately equal heights from the ground.

a) NOTE: Be sure all nuts are facing the interior side of the shelter to avoid tearing the cover and doors.

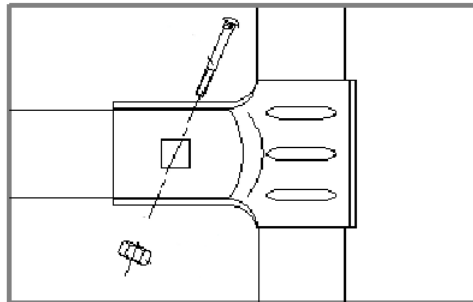
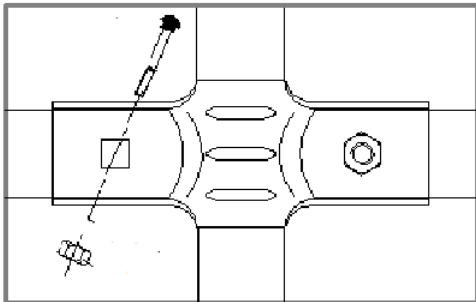
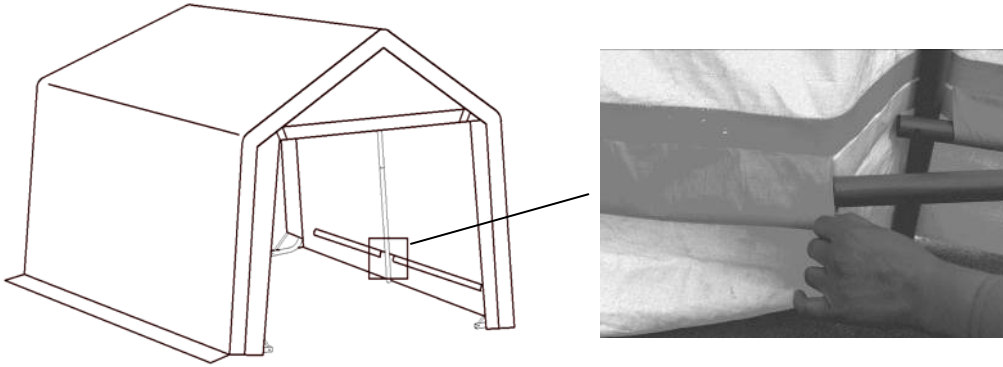

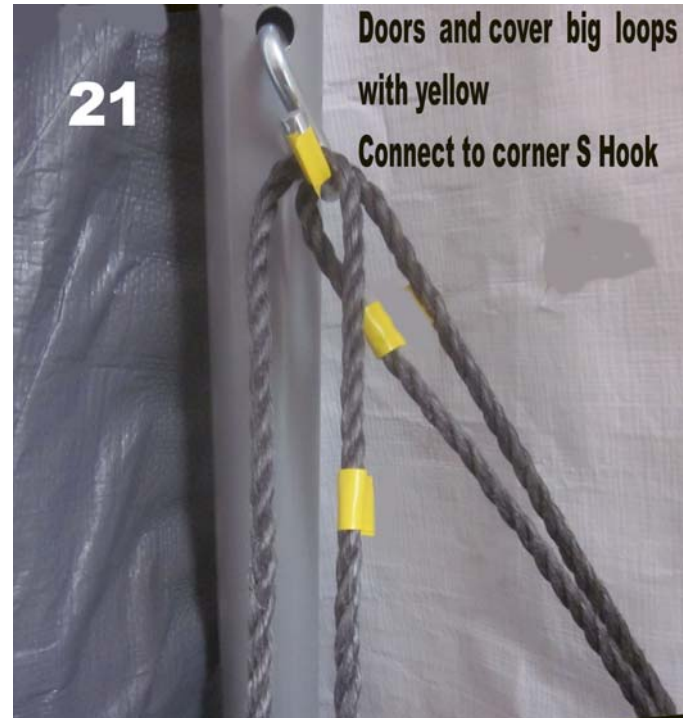
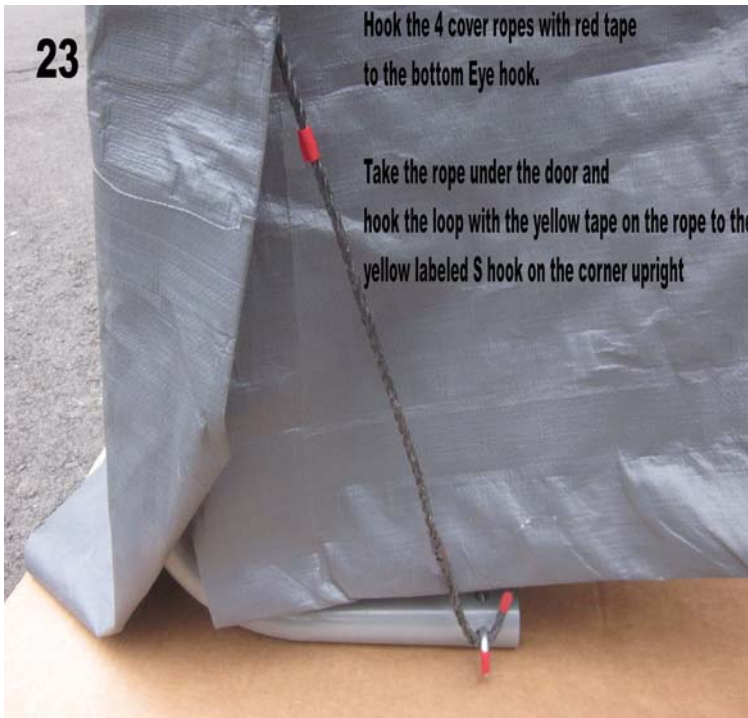
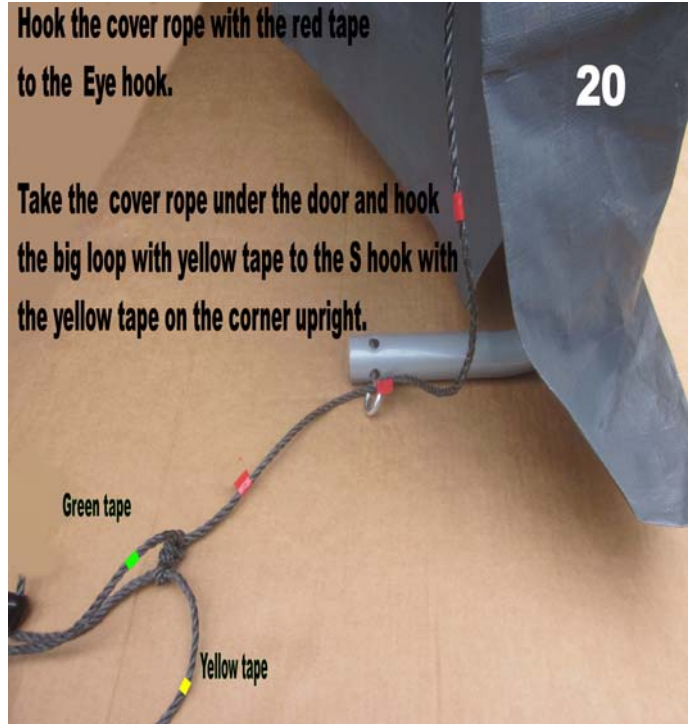
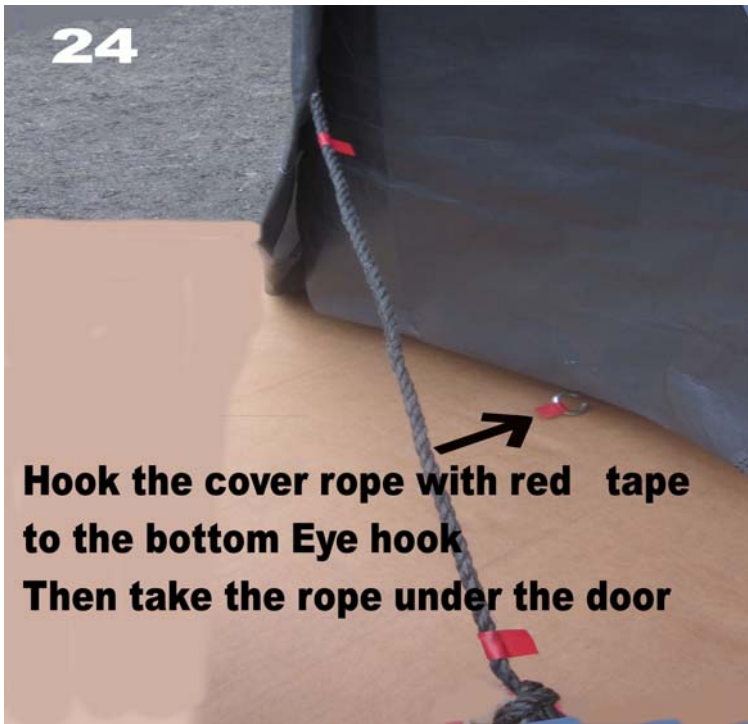

## Cover Tensioning Visit Shelterit.com for installation Video

Find the ropes coming out of the 4 corners of cover with the big loops with **yellow.....label**

You will see **2 red.....** labels on the rope before the big loop **Detail 20 & 24**

Hook the cover rope that has the **2 red.....** labels in the same eye hook that you used for the door on the outside of the shelter  
**Detail 20**

After hooking to rope to the eye hook with red **.....** label , bring the rope under the door **Detail 23**

Hook the big loop with the **yellow.....** label on the same S hook the door is hooked on.

Both door rope and covers rope will be on the same S hook **Detail 21**

Before pulling the cover tight

Even the cover on all 4 sides

Make sure the side pocket for the cross rails that run front to back on the inside of the shelter are equal to the ground

Take the end of the rope with the **green.....** label and ball and pull up to make the big loop with the **yellow.....** label smaller. This will tighten the cover to the frame. **Details 19**

Lightly and temporarily tie off rope with a knot.

Walk around the shelter to make sure the cover and door are even

Do a final tightening of the cover to the frame. Firmly pull up so the rope is tight and tie off the rope around the main rope with a few knots

**Details 19**

After the cover is tightened on the 4 corners with the ropes.

Push and slide the bottom clamps down that are connected to the side cross rails to snug the sides of the cover to the frame.

Tighten the bolts of the cross rail clamps.



## Step 8: Square and Anchoring the Shelter

- a) Ensure the frame is in the final desired location.
- b) Check the measurement of 12' in the front and back of the shelter.
- c) Take a diagonal measurement, cross-corner to cross-corner. When these two measurements are equal the shelter is square. If not equal, tap the corner leg of the longer measurement with the rubber mallet, in the direction of the diagonally opposite leg to push (decrease) the length of the distance. Repeat (always taping against the longer measure) until both diagonals are equal.
- d) Once equal, check the width measurements again to ensure all are correct

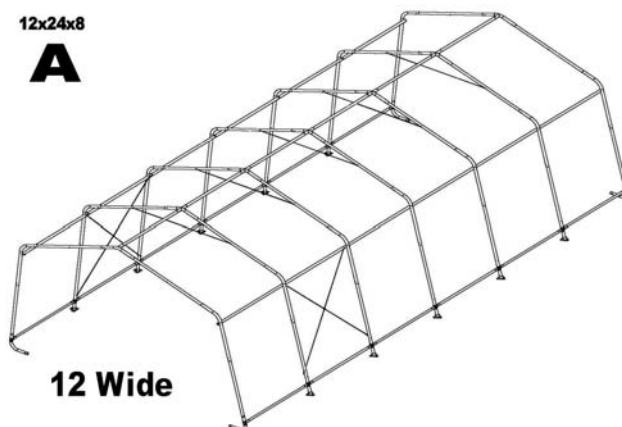

- e) Next, at the curved feet of the shelter install anchors, by screwing the Temporary removable anchors in to the ground and to the inside of the shelter.
- f) Secure with wire cable and cable clamp as shown in **Diagram M** below.

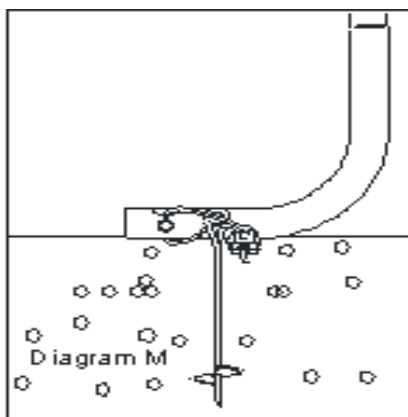

It is recommended that you buy permanent anchors for the shelter

Visit [Shelterit.com](http://Shelterit.com) for permanent anchors and replacement parts

**PLEASE RE-READ ALL WARNINGS CONTAINED ON PAGE 3 OF THESE INSTRUCTIONS. SAVE THESE INSTRUCTIONS FOR FUTURE USE.**

To dismantle, execute all instructions in reverse order.

Store your shelter in a cool, dry location between seasons to prolong usable life of all components. Components are not equally durable and will require replacement over time at differing intervals.

## LIMITED WARRANTY

This product is guaranteed for **1 year from the date of original retail purchase** against defects in materials and workmanship.

Subject to the conditions and limitations described below, this product, must be returned **with proof of purchase** within the stated warranty period and if covered under this warranty, will be replaced (fully or partially with the same model or one of equal value or specification) at the Manufacturer's option.

Liability is restricted to repair or replacement only and does not include any related labor costs of installation, dismantling, repair or transportation costs.

### These warranties are subject to the following conditions and limitations:

- a) A bill of sale verifying the purchase and purchase date must be provided.
- b) This warranty will not apply to any product or part thereof which is worn, broken or which has become inoperative due to abuse, misuse, accidental damage, neglect or lack of proper installation, operation or maintenance (as outlined in the applicable owner's manual or operating instructions) or which is being used for industrial, professional, commercial or rental purposes.

---

- c) This warranty will not apply to normal wear and tear or to expendable parts or accessories that may be supplied with the product which are expected to become inoperative or unusable after a reasonable period of use.
- d) This warranty will not apply to routine maintenance and consumable items such as the cover, rope, nuts, bolts, etc.
- e) This warranty will not apply where damage is caused by repairs made or attempted by others (i.e. persons not authorized by the manufacturer).
- f) This warranty will not apply to any product that was sold to the original purchaser as a reconditioned or refurbished product (unless otherwise specified in writing).
- g) This warranty will not apply to any product or part thereof if any part from another manufacturer is installed therein or any repairs or alterations have been made or attempted by unauthorized persons.
- h) This warranty will not apply to normal deterioration of the exterior finish, such as, but not limited to, scratches, dents, paint chips, or to any corrosion or discolouring by heat, cold, abrasive and chemical cleaners.
- i) This warranty will not apply to component parts sold by and identified as the product of another company, which shall be covered under the other product manufacturer's warranty, if any.

### Additional Limitations

This warranty applies only to the original purchaser and may not be transferred. Neither the retailer nor the manufacturer shall be liable for any other expense, loss or damage, including, without limitation, any indirect, incidental, consequential or exemplary damages arising in connection with the sale, use or inability to use this product.

### Notice to Consumer

This warranty gives you specific legal rights, and you may have other rights, which may vary from province to province state to state. The provisions contained in this warranty are not intended to limit, modify, take away from, disclaim or exclude any statutory warranties set forth in any applicable provincial or federal legislation.

Manual 12x24x8 6 21 16

## Parts Alert!

If you have a question or if there are missing parts, please call:

**203-591-9032**

Or email **Service@shelterit.com**

**Monday-Friday 9:00am-5:00 p.m. EST**

**Missing parts will be sent to you via courier.**

**Visit ShelterIt.com for instructional video**

**DO NOT RETURN TO STORE!**