



# USER'S MANUAL

## WINDOW AIR CONDITIONERS

**WA-6022S: 6,000 BTU**

**WA-8022S: 8,000 BTU**

**WA-1022S: 10,000 BTU**

**WA-1222S: 12,000 BTU**

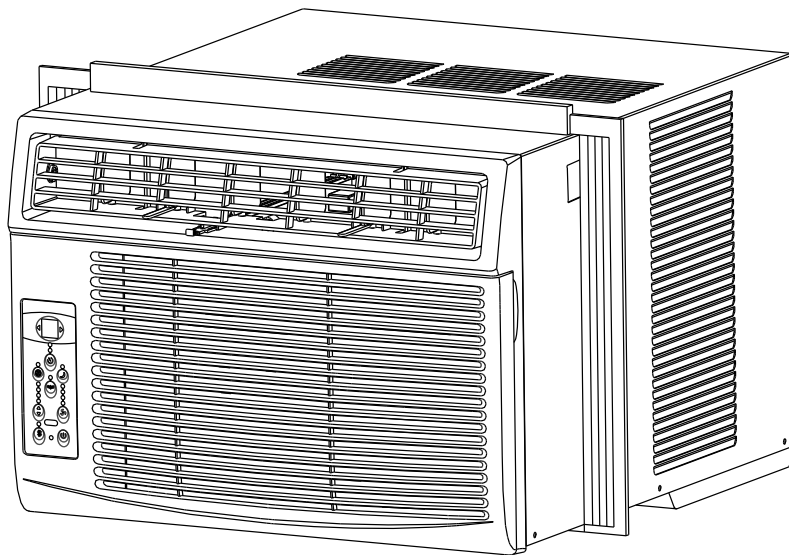

### MULTI-STEP SPEED ELECTRONIC CONTROL

#### TABLE OF CONTENTS

Important Safety Instructions .....	1-3	Air Conditioner Features.....	8-10
Installation Instructions.....	4-7	Care and Cleaning.....	10
Normal Sounds.....	8	Remote Control.....	11-13
		Troubleshooting Tip.....	14





**Before using your air conditioner, please read this manual carefully and keep it for future reference.**

# IMPORTANT SAFETY INSTRUCTIONS

















## READ THIS MANUAL

Inside you will find many helpful hints on how to use and maintain your air conditioner properly. Just a little preventive care on your part can save you a great deal of time and money over the life of your air conditioner. You'll find many answers to common problems in the chart of troubleshooting tips. If you review our chart of Troubleshooting Tips first, you may not need to call for service at all.

To prevent injury to the user or other people and property damage, the following instructions must be followed. Incorrect operation due to ignoring of instructions may cause harm or damage. Please note the following symbols:

 <b>WARNING</b>	This symbol indicates the possibility of death or serious injury.		
 <b>CAUTION</b>	This symbol indicates the possibility of injury or damage to property.		
	<b>Never do this.</b>		<b>Always do this.</b>

## WARNING

<p> Plug in power plug properly.</p> <ul style="list-style-type: none"> <li>Otherwise, it may cause electric shock or fire due to excess heat generation.</li> </ul>	<p> Do not operate or stop the unit by inserting or removing the power plug.</p> <ul style="list-style-type: none"> <li>It may cause electric shock or fire due to heat generation.</li> </ul>	<p> Do not damage or use an unspecified power cord.</p> <ul style="list-style-type: none"> <li>It may cause electric shock or fire.</li> <li>If the power cord is damaged, it must be replaced by the manufacturer or an authorised service center or a similarly qualified person in order to avoid a hazard.</li> </ul>
<p> Always install circuit breaker and a dedicated power circuit.</p> <ul style="list-style-type: none"> <li>Incorrect installation may cause fire and electric shock.</li> </ul>	<p> Do not operate with wet hands or in damp environment.</p> <ul style="list-style-type: none"> <li>It may cause electric shock.</li> </ul>	<p> Do not direct airflow directly at room occupants.</p> <ul style="list-style-type: none"> <li>This is not beneficial to one's health.</li> </ul>
<p> Always ensure proper grounding.</p> <ul style="list-style-type: none"> <li>Incorrect grounding may cause electric shock.</li> </ul>	<p> Do not allow water to run into electric parts.</p> <ul style="list-style-type: none"> <li>It may cause failure of machine or electric shock.</li> </ul>	<p> Do not modify power cord length or share the outlet with other appliances.</p> <ul style="list-style-type: none"> <li>It may cause electric shock or fire due to heat generation.</li> </ul>
<p> Do not open the unit during operation</p> <ul style="list-style-type: none"> <li>It may cause electric shock.</li> </ul>	<p> Do not use the socket if it is loose or damaged.</p> <ul style="list-style-type: none"> <li>It may cause fire and electric shock.</li> </ul>	<p> Unplug unit immediately if strange sound, smell or smoke is emitting from unit.</p> <ul style="list-style-type: none"> <li>It may cause fire and electric shock.</li> </ul>
<p> Keep firearms away.</p> <ul style="list-style-type: none"> <li>It may cause fire.</li> </ul>	<p> Keep power cord away from heat sources</p> <ul style="list-style-type: none"> <li>It may cause fire and electric shock.</li> </ul>	<p> Do not use the power cord near flammable gas or combustibles, such as gasoline, benzene, thinner, etc.</p> <ul style="list-style-type: none"> <li>It may cause an explosion or fire.</li> </ul>
<p> If there was a gas leak from another appliance, ventilate the room thoroughly before operating the unit.</p> <ul style="list-style-type: none"> <li>It may cause explosion, fire and, burns.</li> </ul>	<p> Do not disassemble or modify the unit.</p> <ul style="list-style-type: none"> <li>It may cause failure and electric shock.</li> </ul>	

# IMPORTANT SAFETY INSTRUCTIONS

## CAUTION

- |   |   |  |
|---|---|--|
| <ul style="list-style-type: none"><li>⊖ When removing and cleaning the filter, be cautious of sharp edges and corners.</li></ul>          | <ul style="list-style-type: none"><li>⊖ Do not situate a pet or house plant in front of unit's direct air flow.</li></ul>                                     | <ul style="list-style-type: none"><li>⊖ Keep room well ventilated if used together with a stove, etc.</li></ul>  |
| <ul style="list-style-type: none"><li>● It may cause an injury.</li></ul>   | <ul style="list-style-type: none"><li>● This could injure the pet or plant.</li></ul>   | <ul style="list-style-type: none"><li>● An oxygen shortage may occur.</li></ul>  |
| <ul style="list-style-type: none"><li>⊖ Do not use strong detergent such as wax or thinner to clean the unit.</li></ul>                   | <ul style="list-style-type: none"><li>⊖ Do not clean the air conditioner with water or spray bottle.</li></ul>  | <ul style="list-style-type: none"><li>⊖ Not intended for special purposes.</li></ul>   |
| <ul style="list-style-type: none"><li>● Appearance may deteriorate due to change of product color or scratching of its surface.</li></ul> | <ul style="list-style-type: none"><li>● Water may enter the unit and degrade the insulation. It may cause an electric shock.</li></ul>                        | <ul style="list-style-type: none"><li>● Do not use this air conditioner to preserve precision devices, food, pets, plants, and art objects. May cause deterioration of quality, etc.</li></ul> |
| <ul style="list-style-type: none"><li>⊖ Stop operation and close the window during a storm or hurricane.</li></ul>                        | <ul style="list-style-type: none"><li>⊖ Before cleaning and maintenance, be sure power is turned off and plug is disconnected.</li></ul>                      | <ul style="list-style-type: none"><li>⊖ Inspect brackets frequently to ensure no damages occurred due to prolonged exposure to elements.</li></ul>   |
| <ul style="list-style-type: none"><li>● Opened window may lead to interior damage of furniture, floor, and others.</li></ul>              | <ul style="list-style-type: none"><li>● Do not clean unit while operating. May cause fire, electric shock or injury.</li></ul>                                | <ul style="list-style-type: none"><li>● If bracket is damaged, there is concern of damage due to falling of unit.</li></ul>  |
| <ul style="list-style-type: none"><li>⊖ Clean filters once every two weeks. Be sure filter is replaced properly.</li></ul>                | <ul style="list-style-type: none"><li>⊖ Remove plug from outlet by grasping the plug, never pull on the cord.</li></ul>                                       | <ul style="list-style-type: none"><li>⊖ Unplug from power source if unit is not to be used for a long time.</li></ul>  |
| <ul style="list-style-type: none"><li>● Operation without filters may cause failure.</li></ul>  | <ul style="list-style-type: none"><li>● It may cause electric shock and damage.</li></ul>   | <ul style="list-style-type: none"><li>● It may cause failure of product or fire.</li></ul>   |
| <ul style="list-style-type: none"><li>⊖ Do not block air inlets and outlets.</li></ul>  | <ul style="list-style-type: none"><li>⊖ Do not place heavy object on the power cord and ensure that the cord is not compressed.</li></ul>                     | <ul style="list-style-type: none"><li>⊖ Do not consume the water drained from the air conditioner.</li></ul>   |
| <ul style="list-style-type: none"><li>● It may cause failure of appliance or accident.</li></ul>  | <ul style="list-style-type: none"><li>● There is danger of fire or electric shock.</li></ul>  | <ul style="list-style-type: none"><li>● It contains contaminants and could make you sick.</li></ul>  |
| <ul style="list-style-type: none"><li>⊖ Use caution when unpacking and installing. Sharp edges can cause injury.</li></ul>                | <ul style="list-style-type: none"><li>⊖ If water enters the unit, turn the unit off and unplug from outlet. Contact a qualified service technician.</li></ul> |  |

## CAUTION

- This appliance is not intended for use by persons (including children) with reduced physical, sensory or mental capabilities or lack of experience and knowledge, unless they have been given supervision or instruction concerning use of the appliance by a person responsible for their safety.
- Children should be supervised to ensure that they do not play with the appliance.
- If the supply cord is damaged, it must be replaced by the manufacturer, its service agent or similarly qualified persons in order to avoid a hazard.
- The appliance shall be installed in accordance with national wiring regulations.
- Do not operate your air conditioner in a wet room such as a bathroom or laundry room.
- Contact an authorized service technician for repair or maintenance of this unit.
- Contact the manufacturer or an installer if you have questions regarding installation of this unit.

# IMPORTANT SAFETY INSTRUCTIONS

## NOTE:

The power supply cord with this air conditioner contains a current detection device designed to reduce the risk of fire. Please refer to the section Operation of Current Device for details. In the event that the power supply cord is damaged, it cannot be repaired, it must be replaced with a cord from the manufacturer.

## WARNING

Avoid fire hazard or electric shock. Do not use an extension cord or an adaptor plug. Do not remove any prong from the power cord.

### Grounding type wall receptacle

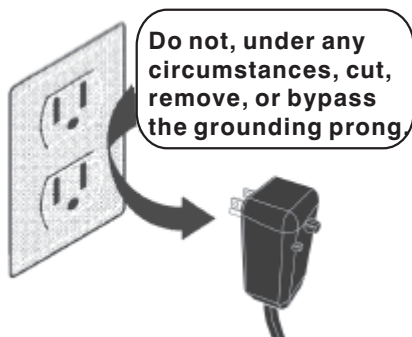

Power supply cord with 3-prong grounding plug and current detection device

## WARNING

### For Your Safety

Do not store or use gasoline or other flammable vapors and liquids in the vicinity of this or any other appliance.

## WARNING

### Prevent Accidents

To reduce the risk of fire, electrical shock, or injury to persons when using your air conditioner, follow basic precautions, including the following:

- Be sure the electrical service is adequate for the model you have chosen. This information can be found on the serial plate, which is located on the side of the cabinet and behind the grille.
- If the air conditioner is to be installed in a window, you will probably want to clean both sides of the glass first. If the window is a triple-track type with a screen panel included, remove the screen completely before installation.
- Be sure the air conditioner has been securely and correctly installed according to the installation instructions in this manual. Save this manual for possible future use in removing or installing this unit.
- When handling the air conditioner, be careful to avoid cuts from sharp metal fins (front and rear coils).

## WARNING

### Electrical Information

The complete electrical rating of your new room air conditioner is stated on the serial plate. Refer to the rating when checking the electrical requirements.

- Be sure the air conditioner is properly grounded. To minimize shock and fire hazards, proper grounding is important. The power cord is equipped with a three-prong grounding plug for protection against shock hazards.
- Your air conditioner must be used in a properly grounded wall receptacle. If the wall receptacle you intend to use is not adequately grounded or protected by a time delay fuse or circuit breaker, have a qualified electrician install the proper receptacle. Ensure the receptacle is accessible after the unit installation.
- Do not run air conditioner without side protective cover in place. This could result in mechanical damage within the air conditioner.
- **Do not use an extension cord or an adaptor plug.**

## Operation of Current Device

The power supply cord contains a current device that senses damage to the power cord. To test your power supply cord do the following:

1. Plug in the Air Conditioner.
2. The power supply cord will have TWO buttons on the plug head. Press the TEST button, you will notice a click as the RESET button pops out.
3. Press the RESET button, again you will notice a click as the button engages.
4. The power supply cord is now supplying electricity to the unit. (On some products this is also indicated by a light on the plug head.)

## NOTE:

- Do not use this device to turn the unit on or off.
- Always make sure the RESET button is pushed in for correct operation.
- The power supply must be replaced if it fails to reset when TEST button is pushed or when it cannot be reset. A new one can be obtained from the manufacturer.
- If power supply cord is damaged, it cannot be repaired. It MUST be replaced by one obtained from the manufacturer.

**NOTE:** This air conditioner is designed to operate under the following conditions:

Cooling	Outdoor temp:	64-109°F/18-43°C
	Indoor temp:	62-90°F/17-32°C

Note: Performance may be reduced outside of these operating temperatures.

# INSTALLATION INSTRUCTIONS

## **STOP** BEFORE YOU BEGIN

Read these instructions completely and carefully.

**IMPORTANT-** Save these instructions for local inspector's use.

**IMPORTANT-** Observe all governing codes and ordinances.

**Note to Installer-** Be sure to leave these instructions with the Consumer.

**Note to Consumer-** Keep these instructions for future reference.

**Skill level-** Installation of this appliance requires basic mechanical skills.

**Completion time-** Approximately 1 hour. We recommend that two people install this product.

Proper installation is the responsibility of the installer.

Product failure due to improper installation is not covered under the Warranty.

You **MUST** use all supplied parts and use proper installation procedures as described in these instructions when installing this air conditioner.

## **!** WINDOW REQUIREMENTS

Your air conditioner is designed to install in standard double hung windows with opening widths of 23 to 36 inches (584mm to 914mm). Lower sash must have sufficient vertical opening for installation (Table 1)

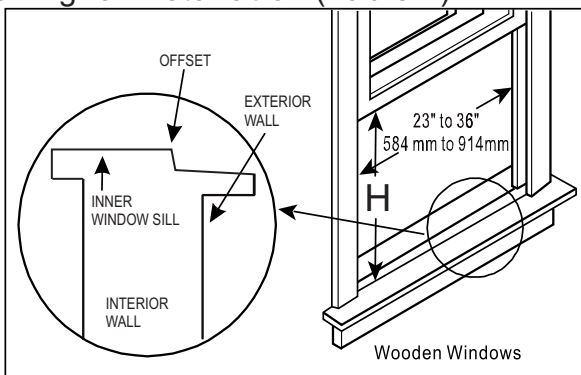

Model	WA-6022S/WA-8022S	WA-1022S/WA-1222S
Min. Vertical Opening	14" (356mm)	15.5" (394mm)

Table 1

## **!** CAUTION

Do not, under any circumstances, cut or remove the third (ground) prong from the power cord.

Do not change the plug on the power cord of the air conditioner.

Aluminum house wiring may present special problems- consult a qualified electrician.

When handling the unit, be careful to avoid cuts from sharp metal edges and aluminum fins located on the front and rear coils.

## TOOLS YOU WILL NEED

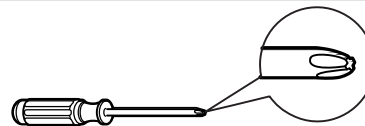

Phillips screwdriver



Leveler

## TOOLS YOU MAY USE



Slotted screwdriver



Pencil

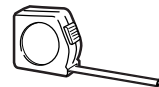

Ruler or tape measure



Scissors or knife

## **!** NOTE:

Save carton and these installation instructions for future reference. The carton is the best way to store unit during winter or when not in use.

# INSTALLATION INSTRUCTIONS

## 1 PREPARE THE WINDOW

Side and rear of unit needs to be clear of obstacles to allow airflow through condenser. The rear of the unit must be outdoors, not inside a building or garage.

### Mounting Hardware



3/4" Screws (7)    Lock Frame (2)    Sash Lock (1)    Foam window seal (1)

## 2 TOP RAIL INSTALLATION

**NOTE:** This step is only applicable to models WA-6022S and WA-8022S

A: Remove the air conditioner from packaging and place on a flat surface.

B: Remove top rail from packaging material as shown in Fig. A.

### Top Rail Hardware



3/8" Screws (4)

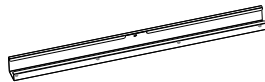

Top Rail (1)

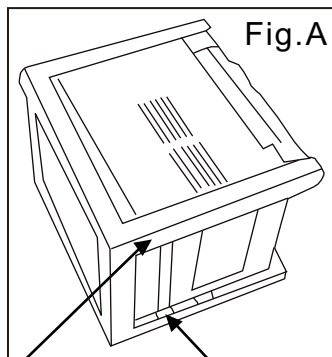

Packaging    Top Rail

C: Align screw openings on the top rail to those on the top of the unit. (Fig.B)

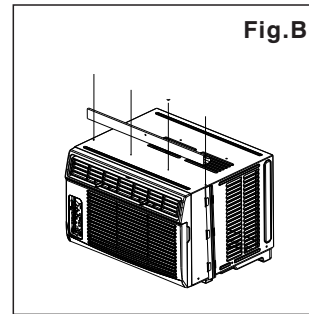

D: Secure top rail to the unit with the 3/8" screws. (Fig.C)

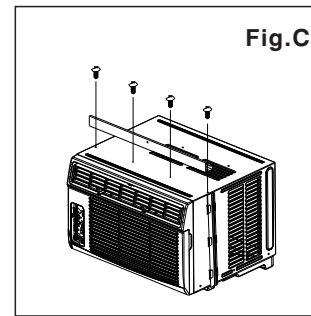

**NOTE:** For safety reasons, all four(4) screws MUST be securely fastened.

**NOTE:** The top rail must be assembled before installing unit.

## 3 INSTALL THE ACCORDION PANELS

**NOTE:** Top rail and side panels at each side are offset to provide the proper pitch to the rear (5/16"). This is necessary for proper condensed water utilization and drainage. If the side panels are not used, this pitch still needs to be maintained.

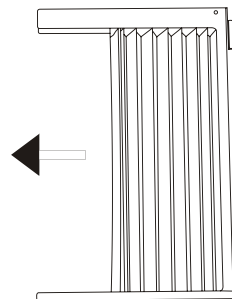

A. Place unit on floor or sturdy table. Hold the side panel firmly in one hand and gently pull back the center to free the open end. (Fig.1)

Fig.1

# INSTALLATION INSTRUCTIONS

- B. Slide the free end "I" section of the panel directly into the cabinet as shown in Fig. 2. Slide the panel down. Be sure to leave enough space to slip the top and bottom of the frame into the rails on the cabinet.

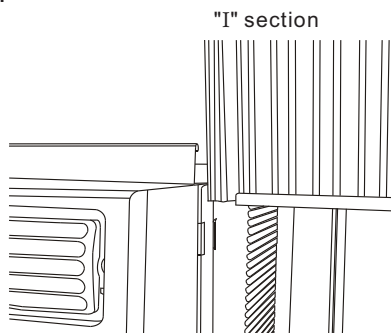

**Fig.2**

- C. Once installed, check to make sure panel sits securely inside the frame channel by making slight adjustments. Slide the top and bottom ends of the frame into the top and bottom rails of the cabinet. Fig.3.

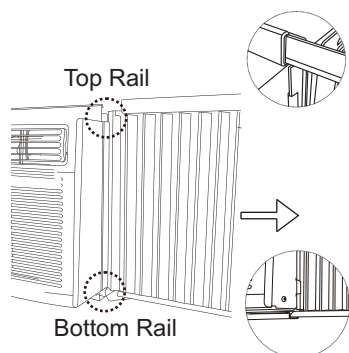

**Fig.3**

- D. Slide the panel all the way in and repeat on the other side.

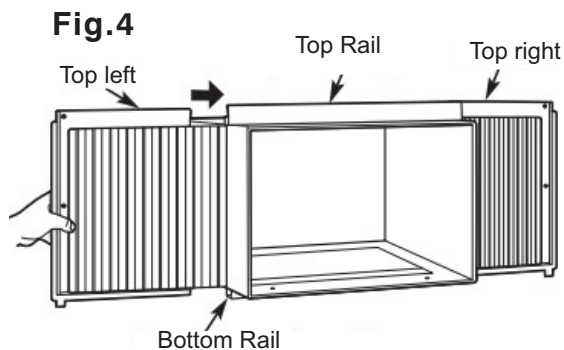
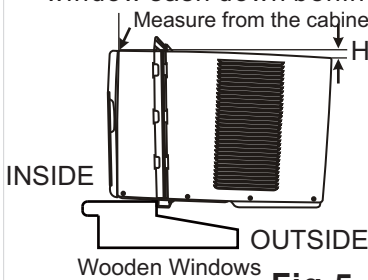

**Fig.4**

**NOTE:** If storm window blocks AC, see Fig. 11.

## 4 INSTALLATION

- A. With a firm grip on the air conditioner, carefully place the unit into the window opening. The bottom of the air conditioner frame should sit against the window sill (Fig.5). Carefully bring the window sash down behind the top rail.



WA-6022S & WA-8022S  
H: Approx. 3/4" to 1"

WA-1022S & WA-1222S  
H: Approx 1" to 1 3/8"

**Fig.5**

**NOTE:** Check that air conditioner is tilted back within the indicated "H" measurement (Fig.5), approximately 3° to 4° downwards to the outside. With proper installation, condensate will drain from the drain hole during normal use.

- B. Extend the side panels out against the window frame (Fig.6).

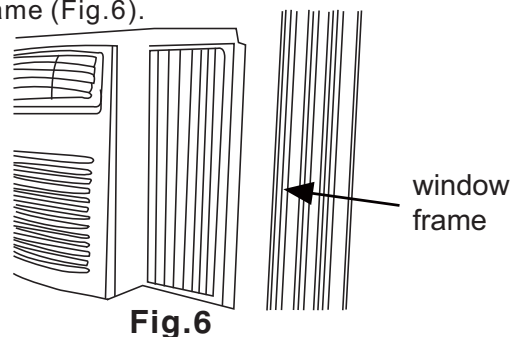

**Fig.6**

- C. Place the frame lock between the frame extensions and the window sill as shown in Fig.7. Drive 3/4" (19mm) through the frame lock and into the sill.

**NOTE:** To prevent window sill from splitting, drill 1/8" pilot holes before driving screws.

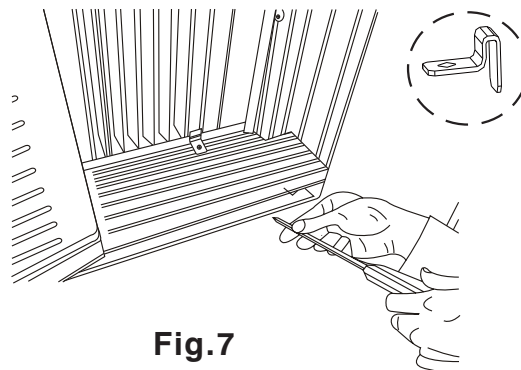

**Fig.7**

# INSTALLATION INSTRUCTIONS

D. Drive 3/4" (19mm) locking screws through frame holes into window sash. (Fig.8)

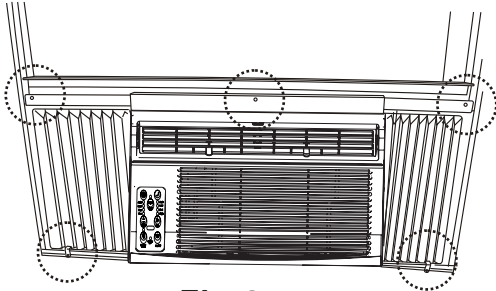

**Fig.8**

E. To secure lower sash in place, attach right angle sash lock with 3/4" (19mm) screw as shown in Fig.9.

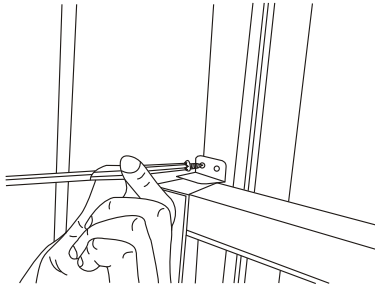

**Fig.9**

F. Cut foam window seal and insert it into the space between the upper and lower sashes (Fig.10).

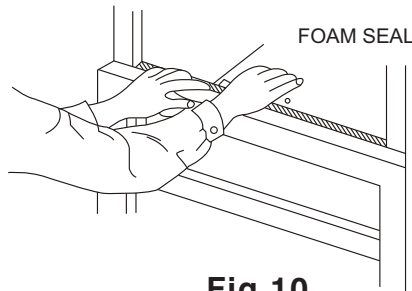
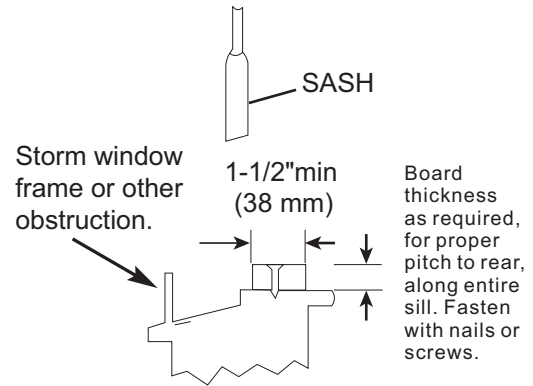

**Fig.10**

## If AC is Blocked by Storm Window

Add wood as shown in Fig.11, or remove storm window before air conditioner is installed.

If Storm Window Frame must remain, be sure the drain holes or slots are not caulked or painted shut. Accumulated rain water or condensation must be allowed to drain out.



**Fig.11**

## Removing AC From Window

- ◆ Turn AC off and disconnect power cord.
- ◆ Remove sash seal from between windows and unscrew safety sash lock.
- ◆ Remove screws installed through frame and frame-lock.
- ◆ Close (slide) side panels into frame.
- ◆ Keeping a firm grip on air conditioner, raise sash and carefully remove.
- ◆ Be carefully not to spill any remaining water while lifting unit from window. Store parts WITH air conditioner.



# NORMAL SOUNDS

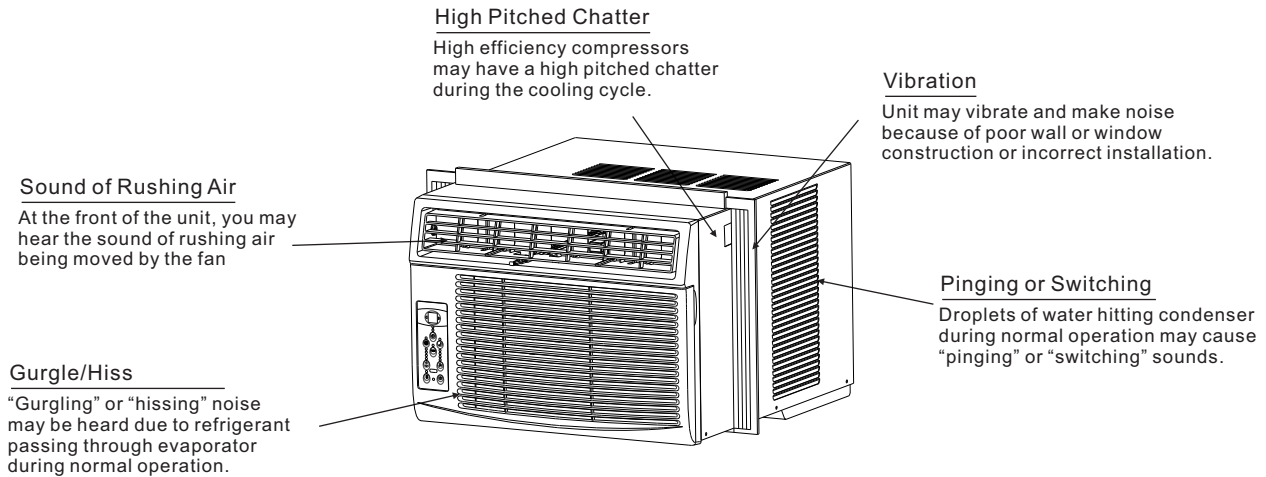

## NOTE:

All the illustrations in this manual are for explanation purpose only. Your air conditioner may be slightly different. The actual shape shall prevail.

# AIR CONDITIONER FEATURES

## ELECTRONIC CONTROL OPERATING INSTRUCTIONS

Before you begin, thoroughly familiarize yourself with the control panel as shown below and all its functions, then follow the symbol for the functions you desire. **The unit can be controlled by the unit control alone or with the remote.**

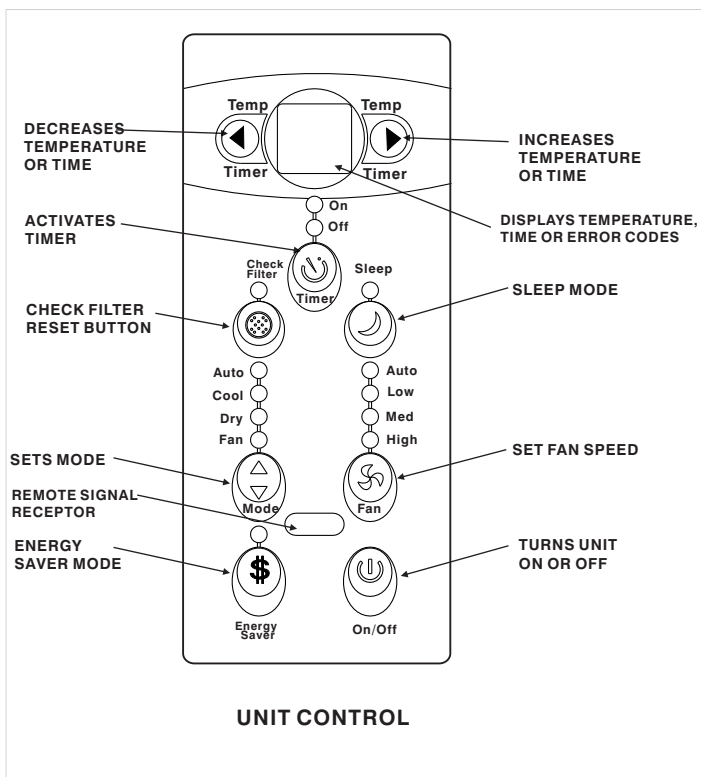

**TO TURN UNIT ON OR OFF:**  
Press **ON/OFF** button to turn unit on or off.  
NOTE: The unit will initiate automatically under the Energy Saver mode.

**TO CHANGE TEMPERATURE SETTING:**  
Press **LEFT/RIGHT** button to change temperature setting.  
NOTE: Press or hold either Right (▶) or Left (◀) button until the desired temperature is seen on the display. This temperature will be automatically maintained anywhere between 62°F (17°C) and 86°F (30°C). If you want the display to show the actual room temperature, refer to "Operate on Fan Only" section.

**TO ADJUST FAN SPEEDS:**  
Press **FAN** to select the Fan Speed in four steps-Auto, Low, Med or High. Each time the button is pressed, the fan speed mode is shifted. On Dry mode, the fan speed is set at Low automatically.

# AIR CONDITIONER FEATURES

## TO SELECT THE OPERATING MODE:

To choose operating mode, press  Mode button. With each press of the button, the mode will cycle through the following sequence: Auto, Cool, Dry and Fan. The indicator light next to each corresponding model will illuminate.

### AUTO mode:

- When the air conditioner is set in AUTO mode, unit will automatically select cooling or fan operation, depending on set and ambient temperature.
- Unit engages COOL mode when ambient temperature is 4°F above set temperature. When ambient temperature falls 2°F below set temperature, unit will switch to Fan.
- Fan speed cannot be adjusted in AUTO mode.

### COOL mode:

- Unit begins cooling when ambient temperature is 2°F above set temperature. When set temperature has been reached, cooling stops and unit switches to Fan mode.

### DRY mode:

- In this mode, the unit will generally operate in the form of a dehumidifier. Since the conditioned space is closed or sealed area, some degree of cooling will continue.

### FAN mode:

- Use this function when cooling is not desired, such as for air circulation or to exhaust stale air. Best to open windows when operating in Fan mode but remember to close windows in Cool mode for maximum cooling efficiency.
- Fan speed can be selected.
- The display will show actual room temperature.
- Temperature cannot be set or adjusted.

## SLEEP FEATURE:

Press  Sleep button to initiate the sleep mode. The unit will operate at set temperature for 30 minutes. After 30 minutes, unit will increase temperature by 2°F. After another 30 minutes, unit will again increase temperature by 2°F. This new temperature will be maintained for 6 hours before unit returns to originally set temperature. This ends the Sleep mode and unit will continue to operate as originally programmed. The Sleep Mode can be cancelled at any time during operation by pressing the Sleep button again.

## CHECK FILTER FEATURE:

Press  Check filter button to initiate this feature. This feature is a reminder to clean the Air Filter for more efficient operation. The LED light will illuminate after 250 hours of operation. Once the filter has been cleaned, press the Check Filter button to reset.

## ENERGY SAVER FEATURE:

Press  Energy Saver button to initiate this feature. This feature can be selected when unit is in COOL, DRY or AUTO mode. When the set temperature has been reached and compressor shuts off, fan will continue to run for another 3 minutes, then cycles on for 2 minutes at 10-minute intervals until the room temperature is above the set temperature, at which point the compressor turns back on and cooling resumes.

## TIMER: AUTO START/STOP FEATURE:

- Press the  TIMER button to program Auto-On or Auto-Off. The corresponding indicator light will illuminate.
- Use the Left/Right arrow buttons to program. Each press is in increment of 0.5 hours up to 10 hours, then in increments of 1 hour up to 24 hours. The control will count down the remaining time.
- Unit will register timer setting after 5 seconds. If unit is on, display will revert back to previous temperature setting or room temperature. If unit is off, there will be no display.
- Turning the unit on or off or adjusting the timer to 0.0 will cancel the timer program.

## DISPLAY:

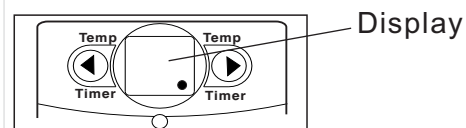

### DISPLAY:

- COOL mode: shows set temperature in "°C" or "°F" and Auto-timer settings.
- FAN mode: shows ambient temperature.

### ERROR CODES:

- "AS" = room temperature sensor error. Unplug the unit, wait 3 minutes and plug it back in. If error persists, call for service.  
NOTE: In FAN mode, it will display "LO" or "HI".
- "•" = Evaporator temperature sensor error. Unplug unit, wait 3 minutes and plug it back in. If error persists, call for service.

## FEATURES (Cont'd)

### AUTO RESTART FEATURE

If the unit breaks off unexpectedly due to power cut, it will restart at the previous function automatically when the power resumes.

### Air Directional Louvers

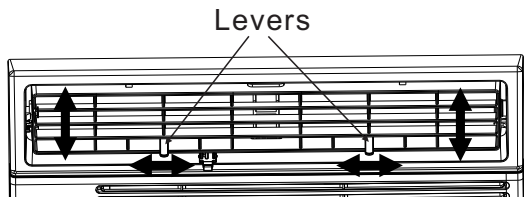

#### Air Direction

Directional louvers can be adjusted Left or Right and Up or Down (not all models). Pivot the louvers until desired direction is obtained.

### ADDITIONAL THINGS YOU SHOULD KNOW

Now that you have mastered the operating procedure, here are more features in your control that you should become familiar with:

- The Cool circuit has an automatic 3-minute time delay when unit is turned off and on quickly. This protects the compressor from overheating and possible circuit breaker tripping. The fan will continue to run during this time.
- The LCD is capable of displaying temperature in Fahrenheit or Celsius. To switch the temperature scale, press and hold the Left and Right buttons simultaneously for 3 seconds.

### Fresh Air Vent Control:

(WA-1022S & WA-1222S only)

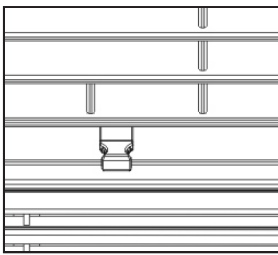

**Fig. A (VENT CLOSED)**  
Circulates indoor air

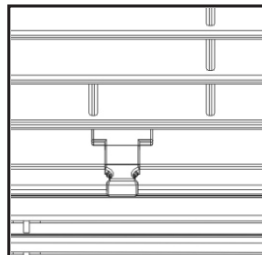

**Fig. B (VENT OPEN)**  
Draw fresh air into the room

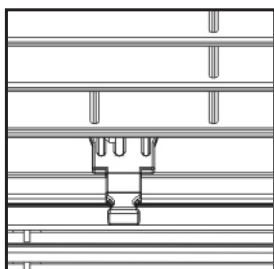

**Fig. C (VENT & EXHAUST OPEN)**  
Indoor and outdoor air exchange

## CARE AND CLEANING

### ⚠ CAUTION

Clean your air conditioner occasionally to keep it looking new. **Be sure to unplug the unit before cleaning to prevent shock or fire hazards.**

### Air Filter Cleaning

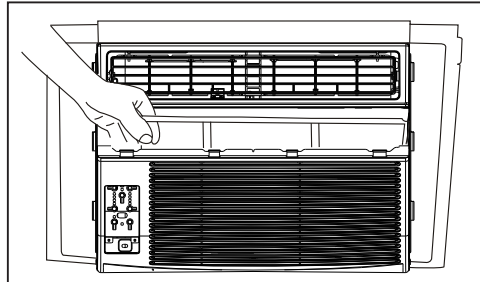

The air filter should be checked at least once a month to see if cleaning is necessary. Trapped particles in the filter can build up and cause an accumulation of frost on the cooling coils:

- Push the vent handle to the Vent Closed position (where applicable). Open the front panel.
- Grasp the filter by the center and pull up and out.
- Wash the filter using liquid dishwashing detergent and warm water. Rinse filter thoroughly.
- Gently shake excess water from the filter. Be sure filter is thoroughly dry before replacing.
- Instead of washing, you may also vacuum the filter.

**Note:** never use hot water over 40°C/104°F to clean the air filter. Never attempt to operate the unit without filter.

### Cabinet Cleaning

- Be sure to unplug the unit to prevent shock or fire hazard.
- The cabinet and front may be dusted with an oil-free cloth or wipe with a cloth dampened in a warm water and mild detergent solution. Wipe clean and dry thoroughly.
- Never use harsh cleaners, wax or polish on cabinet front.
- Be sure to wring excess water from the cloth before wiping the controls. Water in or around the controls may cause damage to the air conditioner.

### Winter Storage

If you plan to store the air conditioner during the winter, remove it carefully from the window according to the installation instructions. Cover it with plastic or return it to the original carton.

# REMOTE CONTROL

Use the remote control within a distance of 20 feet and 180 degree radius to the front of the AC unit. Point the remote towards the receiver.

Reception is confirmed by a beep.

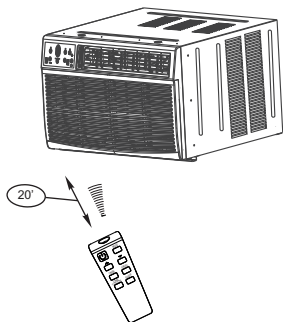

## ⚠ CAUTIONS

- The air conditioner will not operate if curtains, doors or other materials block the signals from the remote controller to the indoor unit.
- Prevent any liquid from falling onto the remote. Do not expose remote to direct sunlight or heat.
- If the infrared signal receiver on the AC unit is exposed to direct sunlight, the unit may not respond properly. Use curtains to prevent sunlight from falling on the receiver.
- If other electrical appliances react to the remote controller, either move these appliances or consult your local dealer.

## REPLACING BATTERIES

The remote is powered by two AAA batteries (not included) housed in the rear and protected by a cover:

- (1) Remove the cover by pressing and sliding off.
- (2) Remove old batteries and insert new batteries, placing the (+) and (-) ends correctly.
- (3) Replace cover by sliding it back into position.

NOTE: when batteries are removed, all programming are erased. After inserting new batteries, the remote controller must be reprogrammed.

## Function buttons

### ON/OFF button

Operation starts when this button is pressed and stops when the button is pressed again.

NOTE: Unit will automatically turn on under Energy Saver mode.

### UP button

Push this button to increase the temperature setting in 1°C/1°F. The highest setting is 30°C/86°F. Or to increase time for timer setting.

### TIMER button

Push this button to activate the "Auto Start" or "Auto Stop" program.

### ONE TOUCH button

Push this button and system will automatically shift to COOL mode with auto fan speed. The set temperature will be 26°C/80°F. Any timer setting will be cancelled.

### MODE button

Press this button to select the desired operation mode: AUTO, COOL, DRY, and FAN.

### DOWN button

Push this button to decrease the temperature setting in 1°C/1°F increments. Lowest setting is 17°C/62°F. Or to decrease time for timer setting.

### FAN button

Press to select the fan speed in four steps: Auto, Low, Med and High.

### SLEEP button

Press this button to activate Sleep mode. This function is available for COOL or AUTO mode only and maintains the most comfortable temperature for you.

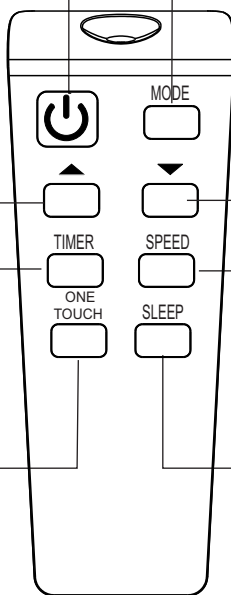

## Using the remote

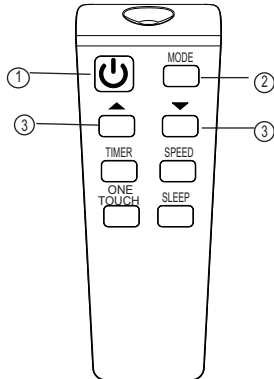

### **Auto mode**

Ensure the unit is plugged in and power is available.

1. Press the **ON/OFF** button to start the air conditioner.
2. Press the **MODE** button to select Auto.
3. Press the **TEMP UP/DOWN** button to set desired temperature. The temperature can be set within a range of 17°C/62°F~ 30°C/86°F in 1°C/1°F increments.

#### NOTE:

- In Auto mode, the unit will choose the operating mode (Cooling or Fan) by sensing the difference between actual ambient temperature and set temperature on remote.
- In Auto mode, fan speed cannot be changed.
- If the Auto mode is not comfortable for you, select the desired mode and set temperature manually.

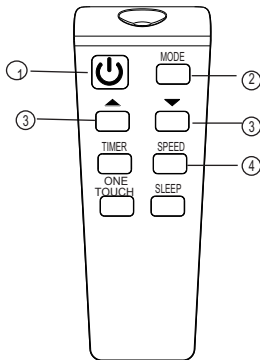

### **Cooling and Fan operation**

Ensure the unit is plugged in and power is available.

1. Press the **ON/OFF** button to start the air conditioner.
2. Press the **MODE** button to select COOL or FAN mode.
3. In COOL mode, press the **TEMP UP/DOWN** button to set the desired temperature. The temperature can be set within the range of 17°C/62°F~30°C/86°F in 1°C/1°F increments.
4. Press the **FAN** button to select the fan speed in four steps: Auto, Low, Med, or High.

#### NOTE:

- In Fan mode, temperature setting is not available, only steps 1,2 and 4 may be performed.

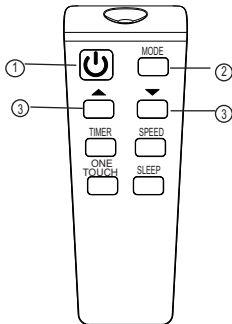

### **Dehumidifying (DRY) mode**

Ensure the unit is plugged in and power is available.

1. Press the **ON/OFF** button to start the air conditioner.
2. Press the **MODE** button to select Dry.
3. Press the **TEMP UP/DOWN** button to set the desired temperature. The temperature can be set within the range of 17°C/62°F~ 30°C/86°F in 1°C/1°F increments.

#### NOTE:

- In Dry mode, fan speed cannot be selected.

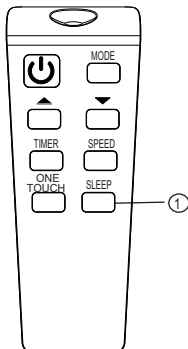

### **SLEEP operation**

Press this button to activate the Sleep mode. This function is available for COOL or AUTO modes only and will maintain the most comfortable temperature for you.

In this mode, unit will run at your set temperature for 30 minutes. After the initial 30 minutes, unit will increase set temperature by 1°C/2°F. After another 30 minutes, unit will again increase temperature by 1°C/2°F. Unit will maintain this new temperature for 6 hours and return to original temperature setting. This ends the Sleep mode.

#### NOTE:

- Sleep mode is cancelled when any of these buttons are pressed: MODE, ON/OFF, FAN SPEED and SLEEP.

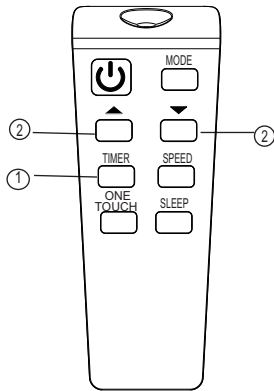

### **Timer operation (Auto-start or Auto-stop)**

Press the TIMER button to initiate the Auto-start and/or Auto-stop program. Timer can be set up to 24 hours.

1. Press the TIMER button to program Timer-On or Timer-Off, the corresponding indicator will illuminate on unit's control panel.
2. Press or hold the UP/DOWN keys to program time in 0.5 hour increments, up to 10 hours, then in 1 hour increments up to 24 hours. Control will count down the remaining time.
3. The programmed time will register after 5 seconds and panel will revert back to displaying the previous temperature setting.

**NOTE:**

- Turning the unit ON or OFF at any time will cancel programmed timer.
- Adjusting time to 0.0 will also cancel TIMER setting.

### **Timer operation (Combined)**

You can program both Timer-On and Timer-Off simultaneously.

**AUTO OFF → AUTO START**

This feature is useful when you want to stop the air conditioner after you go to bed and start it again in the morning when you wake up or when you return home.

Example:

To stop the air conditioner after 2 hours and start it again in 10 hours.

1. Press the TIMER button until the TIMER-OFF indicator is displayed on unit's control panel.
2. Use the UP/DOWN button to set "2.0" hours.
3. Press the TIMER button again until TIMER-ON is displayed on control panel.
4. Use the UP/DOWN button to set "10" hours.
5. Wait for 5 seconds for program to be registered and panel to revert back to previous display.

**AUTO START → AUTO OFF**

This feature is useful when you want to start the air conditioner before you wake up and stop it after you leave the house.

Example:

To start the air conditioner in 5 hours and stop it after 8 hours:

1. Press the TIMER button until the TIMER-ON indicator is displayed on unit's control panel.
2. Use the UP/DOWN button to set "5.0" hours.
3. Press the TIMER button again until TIMER-OFF is displayed on control panel.
4. Use the UP/DOWN button to set "8" hours.

Wait for 5 seconds for program to be registered and panel to revert back to previous display.

### **Remote Controller Specifications**

<b>Rated Voltage</b>	3.0V( Dry batteries Lr03x2)
<b>Lowest Voltage of CPU Emitting Signal</b>	2.4V
<b>Signal Receiving Range</b>	5m
<b>Environment</b>	-5°C ~ 60°C (23°F ~ 140°F)

**NOTE:** All the illustrations are for explanation purposes only. The actual shape of remote controller may be slightly different.

The design and specifications are subject to change without prior notice for product improvement. Consult with the manufacturer for details.

# TROUBLESHOOTING TIPS

Before calling for service, review this list. It may save your time and expense. This list includes common occurrences that are not the result of defective workman-ship or materials in this appliance.

<b>Problem</b>	<b>Solution</b>
<b>Air conditioner does not start</b>	<ul style="list-style-type: none"> <li>· Wall plug disconnected. Push plug firmly into wall outlet.</li> <li>· Blown fuse/tripped circuit breaker. Replace fuse with time delay type/reset circuit breaker.</li> <li>· Plug's current device tripped. Press the RESET button.</li> <li>· Power is OFF. Turn unit ON and set to desired setting.</li> </ul>
<b>Air from unit does not feel cold enough</b>	<ul style="list-style-type: none"> <li>· Room temperature is below 62°F(17°C). Unit's lowest temperature range is at 62°F(17°C).</li> <li>· Temperature sensor (located behind air filter) is touching the cooling coil. Gently bend the element away from the coil.</li> <li>· Set temperature has been reached, lower the set temperature.</li> <li>· Compress stopped due to mode change. Wait 3 minutes for compressor to restart.</li> </ul>
<b>Air conditioner cooling but room is too warm - ice on the coils</b>	<ul style="list-style-type: none"> <li>· Outdoor temperature is below 64°F(18°C). To defrost the coil, set FAN ONLY mode.</li> <li>· Air filter may be dirty, clean filter. Refer to Care and Cleaning section.</li> <li>· Thermostat set too cold for nighttime cooling, set at a higher temperature.</li> <li>· To defrost coil, set to FAN only mode.</li> </ul>
<b>Air conditioner cooling, but room is too warm - NO ice on the coils.</b>	<ul style="list-style-type: none"> <li>· Air filter is dirty and restricting air flow. Clean air filter.</li> <li>· Directional louvers positioned improperly. Position louvers for better air distribution.</li> <li>· Temperature is set too high, set to a lower temperature setting.</li> <li>· Front of unit is blocked by drapes, blinds, furniture, etc. - restricting air flow, clear blockage.</li> <li>· Door and/or windows are open, allowing cold air to escape. Close door and windows.</li> <li>· Unit recently turned on in a warm room, allow additional time to remove "stored heat" from walls, ceiling, floor and furniture.</li> </ul>
<b>Unit turns on and off rapidly</b>	<ul style="list-style-type: none"> <li>· Dirty air filter restricting airflow. Clean air filter.</li> <li>· Outside temperature is extremely hot. Set FAN speed to a higher setting to bring air past cooling coils more frequently.</li> </ul>
<b>Noise when unit is cooling</b>	<ul style="list-style-type: none"> <li>· Air movement sound. This is normal . If too loud, set to a slower FAN setting.</li> <li>· Window vibration - poor installation. Refer to installation guide or check with installer.</li> </ul>
<b>Water dripping INSIDE when unit is cooling.</b>	<ul style="list-style-type: none"> <li>· Improper installation. Tilt air conditioner slightly to the outside to allow water drainage. Refer to installation instructions or check with installer.</li> </ul>
<b>Water dripping OUTSIDE when unit is cooling.</b>	<ul style="list-style-type: none"> <li>· Unit removing large amount of moisture from humid room. This is normal during excessively humid days.</li> </ul>
<b>Remote Sensor Deactivating Prematurely</b>	<ul style="list-style-type: none"> <li>· Remote not used within range. Use remote within 20 feet and 180° radius to front of unit.</li> <li>· Remote signal obstructed. Remove obstruction.</li> <li>· Check battery.</li> </ul>
<b>Room too cold</b>	<ul style="list-style-type: none"> <li>· Set temperature is too low. Increase set temperature.</li> </ul>



## Your Guarantee

If this product is found to be faulty as a result of faulty materials or workmanship within one year from date of purchase, it will be repaired free of charge.

This guarantee is subject to the following terms:

- Sunpentown must be notified of the fault.
- Proof of purchase must be presented to Sunpentown's nominated representative.
- The warranty will be void if the product is modified, misused or repaired by an unauthorized person.
- The warranty after repair will not be extended beyond the original one-year period.
- All replacement parts will be new or reconditioned.
- Parts, which are replaced, become the property of Sunpentown.
- The warranty applies for the use of the product in the USA only.

What is NOT COVERED:

- Warranty does not include freight charges.
- Damage due to installation error, product abuse and/or misuse.
- Incidental or consequential damage caused by possible defects with this product.
- Labor cost incurred for the installation and/or removal of a possible defective unit.
- Damage to product caused by improper power supply voltage, accident, fire, floods or acts of nature.
- Failure of product resulting from unauthorized modifications to the product.
- Improper installation or failure to perform the necessary maintenance.
- Normal wear and tear on parts or replacement of parts designed to be replaced.
- Damage to personal property from use of product.
- Replacement or repair of household fuses, circuit breakers, wiring or plumbing.

This GUARANTEE is in addition to your Statutory Rights

SUNPENTOWN INTERNATIONAL INC.  
14625 Clark Ave. City of Industry, CA 91745  
Tel: 800-330-0388  
service@sunpentown.com  
[www.sunpentown.com](http://www.sunpentown.com)