

Assembly Instructions

Item# D-GZ105PST-C

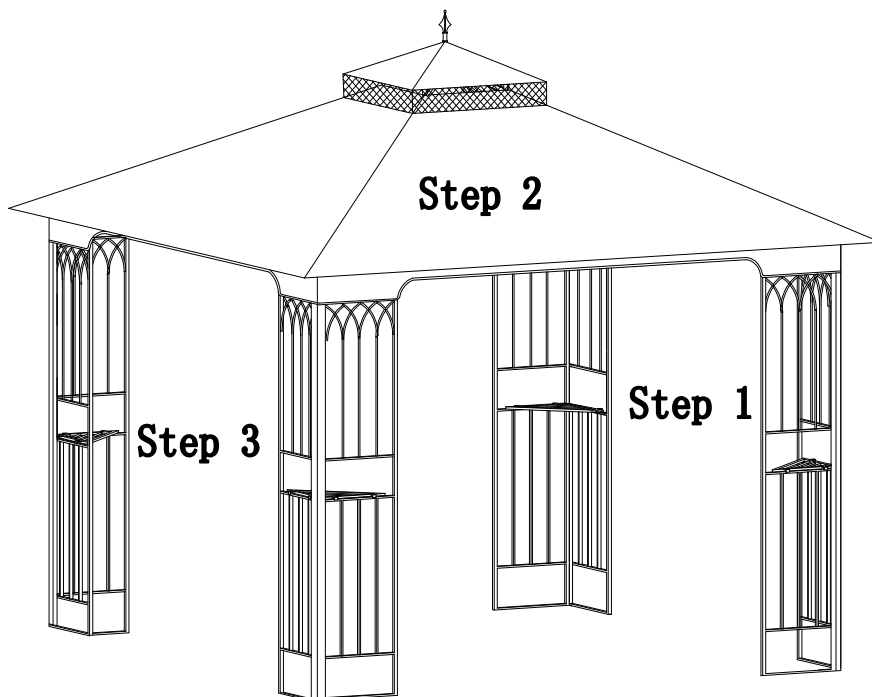
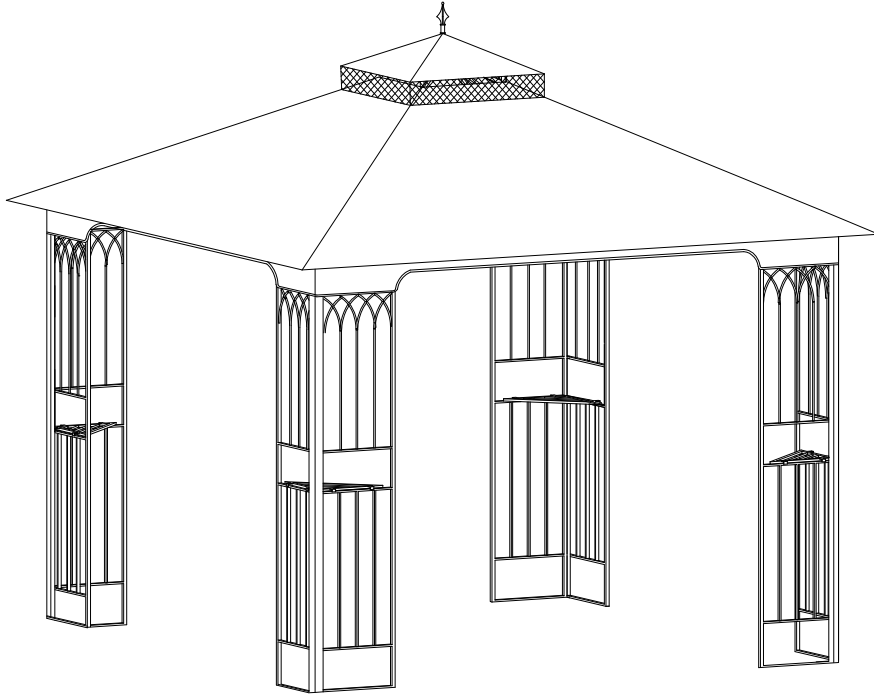

SAFETY INFORMATION

Please read and understand this entire manual before attempting to assemble, operate or install the product.

WARNING:

1. When installing and assembling your gazebo, it is recommended that 2 or more adults are involved.
2. This product is intended for outdoor use only and should be placed on flat, horizontal ground.
3. Ensure enough clearance around the product.
4. Do not use the unit during an electrical storm, as there is a remote chance of getting struck by lightning.
5. Do not climb on top of the gazebo. Falling off the gazebo can result in serious injury, possibly even death.
6. Never barbecue under this gazebo or use lanterns that contain naked flames.
7. This package contains small items and plastic bags that should be kept away from children.
8. Ensure that all connectors & poles are firmly secured in position fully. It is important to do so before use so as to avoid collapsing or damage to the item, which could result in injury.
9. **WARNING:** Keep all flame and heat sources away from this tent fabric. This tent is made with fabric that meets CPAI – 84 specifications for flame resistance. It is not fire proof. The fabric will burn if left in continuous contact with any flame source. The application of any foreign substance to the tent fabric may render the Flame-resistant properties ineffective.
10. **WARNING:** Please take down the gazebo during strong wind. The manufacturer or retailer is not liable for any loss of the product or other items due to the failure to take down the gazebo during strong wind.
11. Hook maximum weight: 26 lbs.









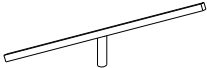

PREPARATION

Before beginning assembly of product, make sure all parts are present. Compare parts with package contents list. If any part is missing or damaged, do not attempt to assemble the product.

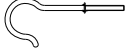
Estimated Assembly Time: 10 minutes.

No Tools Required for Assembly!

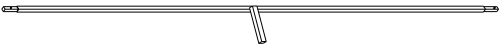
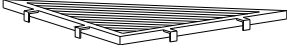
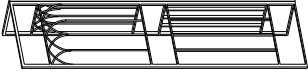
Parts List

Description	Part	Quantity	Image
Finial	A	1	
Top connector	B	1	
Short oblique beam	C	4	
Connector	D	1	
Top Hook	E	1	
Middle beam	F	4	
Long oblique beam	G	4	
Oblique beam	H	4	
Beam	I	4	
Shelf	J	4	
Screen	K	4	
Big canopy	L	1	
Small canopy	M	1	

Hardware Pack

FF	Dia.6x180MM Stake	16 PCS	
----	-------------------	--------	--

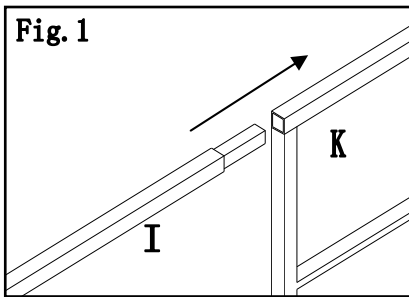
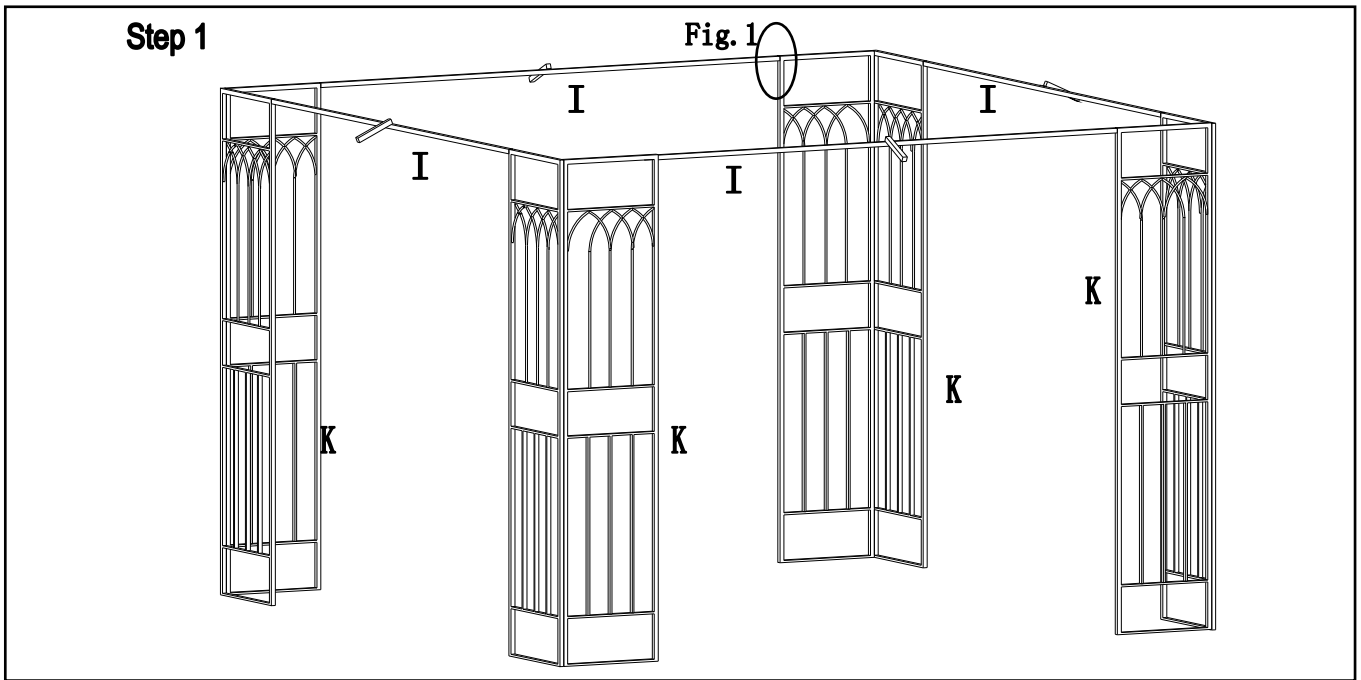

Fig.1: Insert Beam (I) into Screen (K).

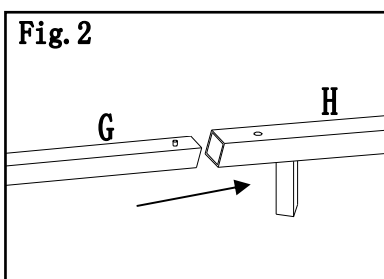
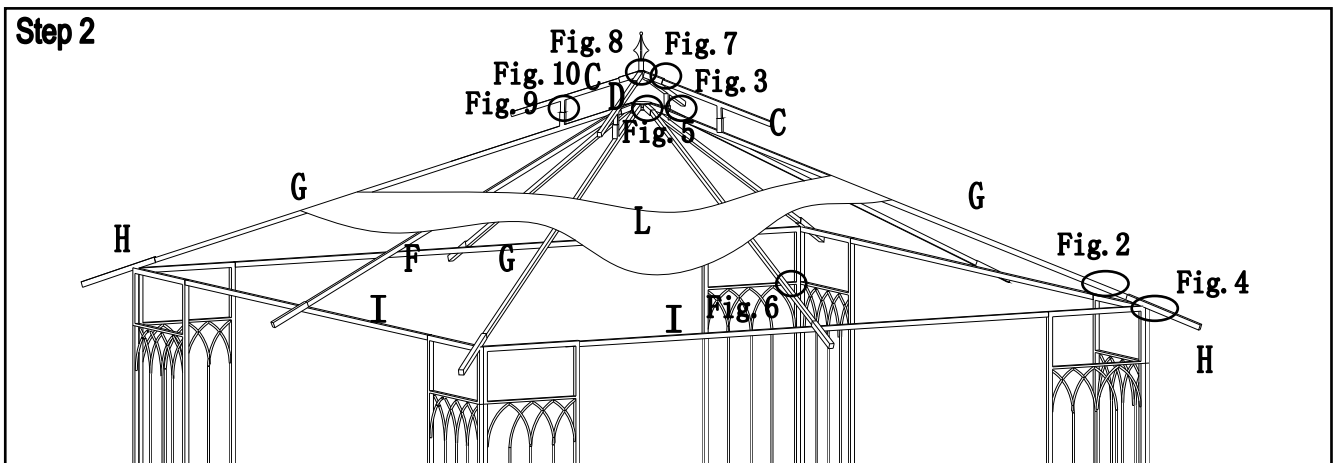

Fig.2: Insert Long oblique beam (G) into Oblique beam (H).

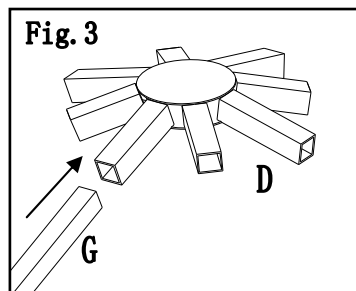

Fig.3: Insert Long oblique beam (G) into the Connect tube (D).

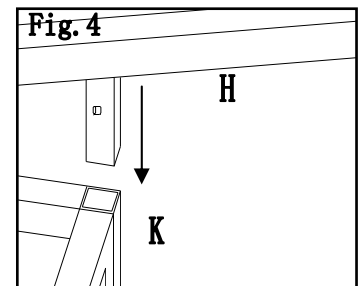

Fig.4: Insert Oblique beam (H) into Screen (K).

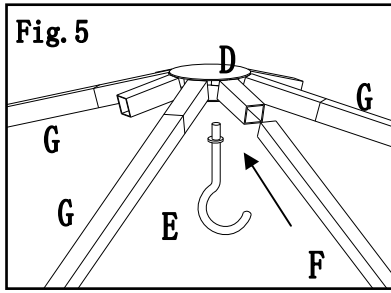

Fig.5: Insert Middle beam (F) into Connector (D), then assemble the Top hook (E) on the connector (D).

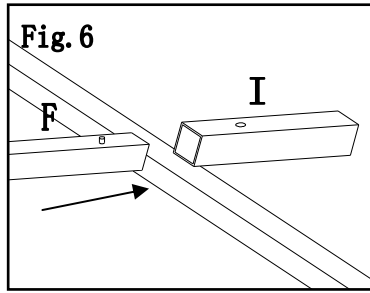

Fig.6: Insert Middle beam (F) into Beam (I). Put on the Big canopy (L) and do not unfold first.

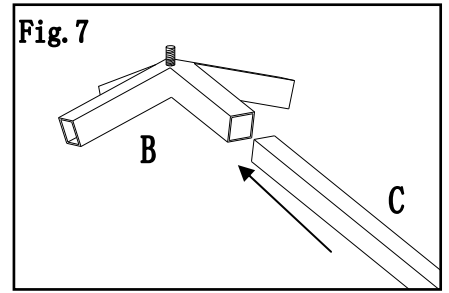

Fig.7: Insert Short oblique beam (C) into Top connector (B).

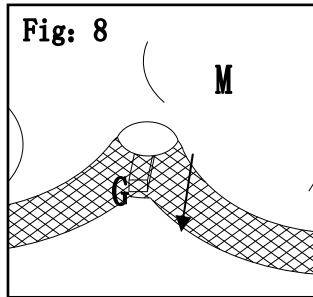

Fig.8: Put on the Small canopy (M) on small top.

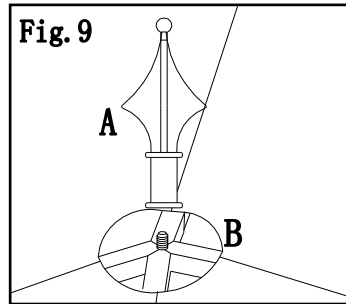

Fig.9: Insert Finial (A) into Top connector (B).

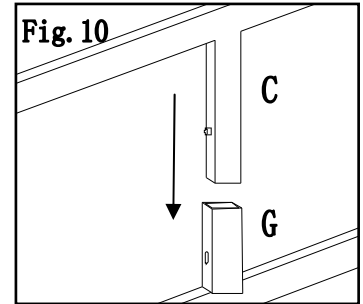
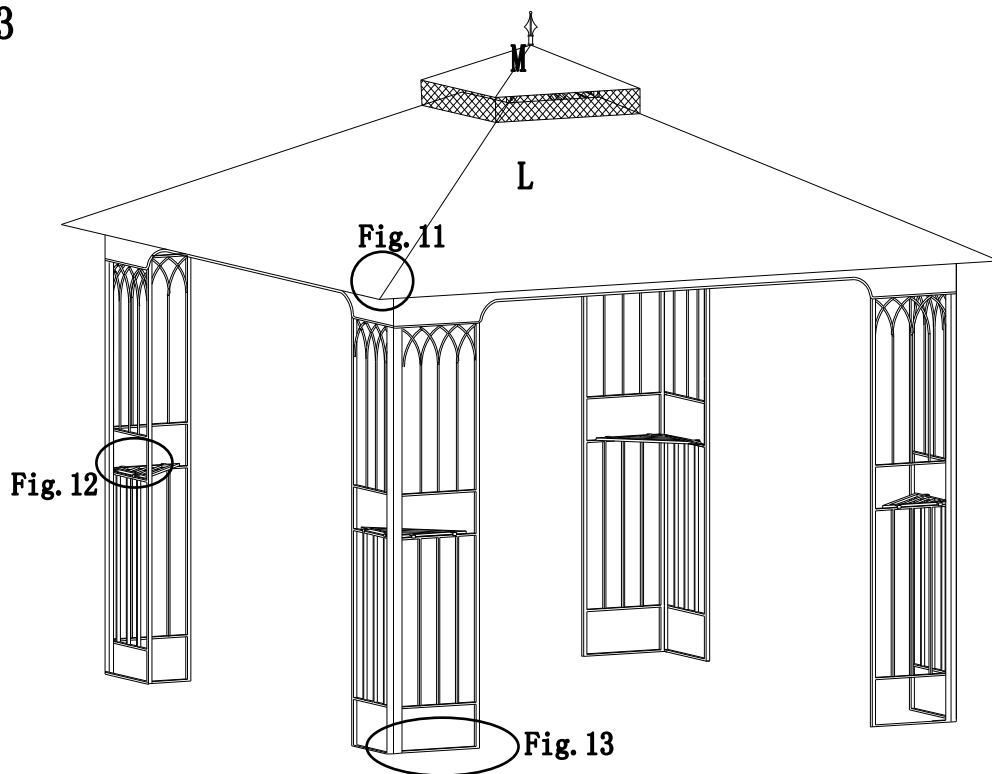

Fig.10: Insert the assembled small dome into Long oblique beam (G) by Short oblique beam (C).

Step. 3



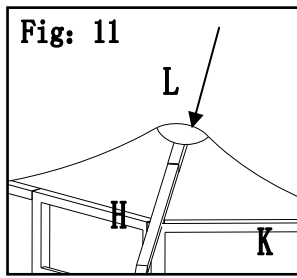

Fig.11: Expand Big canopy (L), secure it to the four corners of the oblique beam and the middle beam.

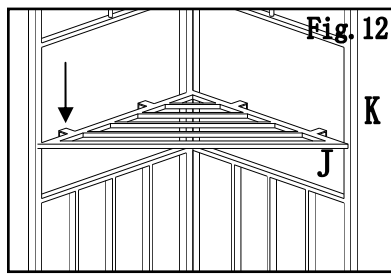

Fig.12: Put Shelf (J) on Screen (K).

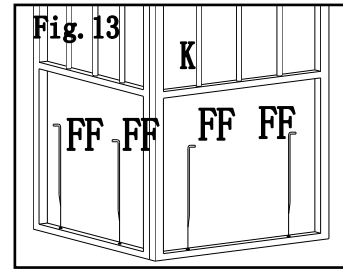

Fig.13: Secure the gazebo to the ground by using the Stakes (FF).

CARE AND MAINTENANCE

This gazebo is intended for decorative and sunshade purposes only, and is not designed to withstand hard weather, including high winds, rain, and snow. In order to avoid damages, remove accumulated water on the roof immediately, or disassemble the gazebo. Disassemble the gazebo in the reverse order of the assembly steps.

Always disassemble the gazebo completely. A partially disassembled gazebo is not stable enough to resist wind and bad weather, and therefore can be damaged and/or cause damage.

Do not use bleach, acid, or other abrasive cleaners on the roof or frame parts.

Steel components of garden accessories and furniture are treated with rust inhibiting paint. However, due to the nature of steel, surface oxidation (rusting) will occur if this protective coating is scratched. This is a natural process. To minimize this condition, it is recommended that care be taken when assembling and handling the product, in order to prevent the paint from being scratched.

Surface rust can be removed easily using a very light application of common cooking oil. If surface oxidation (rusting) occurs and no measures are taken to correct it, the oxidation may start dripping onto the assembly surface, which may cause damaging stains that may be difficult to remove.

If the product will not be used for a long period (e.g. winter time), it should be stored in a clean, dry environment.

Keep the original packaging to store the gazebo.

Important: Please do not return this product to the store. For technical assistance on assembly or replacement parts. Please call Sunjoy Industries at 1-866-578-6569 from 8:00 am EST to 8:00 pm PST or fax the replacement part form which is in the box to 1-740-283-3549 or Email customer.care@sunjoygroup.com for assistance.