

# ONDUVILLA®

The Attractive Alternative to Shingles

I N S T A L L A T I O N   I N S T R U C T I O N S



## INSTALLATION INSTRUCTIONS

Even though ONDUVILLA® is easy to install, it is important to read through these instructions to understand how they apply to your roof. ONDUVILLA®, like all roofing materials, should be carefully installed. Take your time and closely follow these installation guidelines. If you require additional assistance, please feel free to call our support team at 800.777.7663 and one of our associates will be happy to help.

### IMPORTANT SAFETY INFORMATION

Please use extreme caution on the roof to insure your personal safety at all times. Be sure that ladders and other such devices are safely positioned and properly secured. OSHA recommends the use of a safety harness when applying roofing. Protective eyewear is recommended when applying fasteners or using power tools. When walking on ONDUVILLA®, wear soft-soled shoes and place your feet on the flat area of the shingle. All roofing is slippery when wet, dusty, frosty or oily...avoid working or walking on the roof if any of these conditions exist. Working on the roof if windy conditions exist can be dangerous and should be avoided. And, like any asphalt product, refrain from walking on in high heat.

**GENERAL INSTRUCTIONS:** This guide addresses basic roofing practice and commonly occurring roof details for the installation of ONDUVILLA®. For additional information and details please call 800.777.7663 to speak with a representative or refer to the website, [onduvilla-usa.com](http://onduvilla-usa.com).

Consult state and local code requirements prior to installation. Follow all OSHA and governmental safety requirements during installation.

**ROOF DECKS:** Use minimum 3/8" (10mm) plywood or OSB decking as recommended by APA-The Engineered Wood Assn. (Refer to local code on framing and sheathing minimum requirements).

**SLOPE:** 2:12 minimum. For 2:12 up to 4:12, a double layer of underlayment is required. For 4:12 or greater, a single layer is required.

**UNDERLAYMENT (LEAK BARRIER):** Install ice and water leak barrier at the eaves in localities where leaks may be caused by water backing up behind ice or debris dams. Consult state and local code for minimum requirements.

**UNDERLAYMENT (ROOF DECK PROTECTION):** Underlayment is primarily used to separate a roof covering from the roof deck, shed water, and provide secondary weather protection for the roof area of the building. Install a minimum of one layer of ASTM D226, Type I No. 15 asphalt-saturated felt applied horizontally in shingle fashion integrated with ice and water leak barrier as required by code. Refer to manufacturer's installation guidelines and fastening requirements. Synthetic underlayment can be substituted for No. 15 asphalt-saturated felt. Consult manufacturer for suitability and installation requirements.

**FASTENERS:** Use only ONDUVILLA® approved fasteners to attach shingles and accessories. Over driving fasteners will damage the shingle as well as create alignment issues of corrugations. Raised fasteners will interfere with the sealing of the shingle. Unless otherwise noted, shingle fasteners should be placed at apex of each corrugation and centered between the two overlapping guides.

**VENTILATION:** For optimal shingle life and to help prevent moisture issues, all roof structures must have proper ventilation to prevent entrapment of moisture-laden

air behind roof sheathing. Ventilation must be designed to meet or exceed current state or local code minimum requirements.

**FLASHING:** Corrosion-resistant flashing must be installed at wall and roof intersections, at gutters, wherever there is a change in roof slope or direction, and around roof penetrations to help prevent leaks.

The darker shaded area of the shingle should be placed at the top.

For correct overlap take care that overlapping guides of upper and lower shingles are aligned.

Only use ONDUVILLA® fasteners for shingles and accessories.

Fasten between overlapping guides unless otherwise noted in guidelines.

When using Closure Strips, position so that fasteners penetrating the shingle also pass through the closure strip.

Warranty protection is only applicable when ONDUVILLA® shingles have been installed using ONDUVILLA® specific installation guidelines.

Supporting structure .....	4
Minimum pitch .....	4
Materials checklist.....	4
Installation principles .....	5
Fastening .....	5
Eaves.....	6
Ridge for pitch below 10/12 .....	7
Ridge for pitch above 10/12 .....	7
Hip .....	8
Valley .....	9
Hips to ridge .....	10
Verge .....	10
Sidewall .....	11
Headwall.....	11
Mono ridge to wall .....	12
Ventilation .....	13
SPECIAL APPLICATION: ONDUVILLA® Flashing adapter .....	14
ONDUVILLA® System Diagram.....	15
Accessories .....	16

# Detailed ONDUVILLA® installation guide

## SUPPORTING STRUCTURE

ONDUVILLA® can be installed on all standard roof structures.



Wooden deck (for example OSB)

## MINIMUM PITCH: 2/12 FOR SOLID DECK

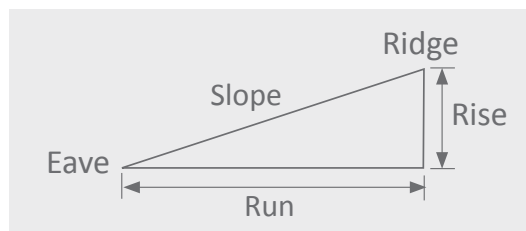

Slope = amount of rise per run  
Example: 3-in rise per 12-in run = 3:12  
Minimum slope required: 2:12

For residential applications, ONDUVILLA® should be installed over solid decking—usually plywood, wood boards, OSB, or planks—with a proper underlayment (felt).

## MATERIALS CHECKLIST

- Hammer
- Screw gun/screw driver
- Measuring tape
- Saw
- Utility knife
- Safety goggles
- Chalk line

## INSTALLATION PRINCIPLES

Start installation at eave. Overlap joints away from entrances and/or away from the point of greatest traffic. This will improve overall appearance.

Position the dark strip "shadow line" at the top.

Stagger each course at least one corrugation from previous piece. Different visual effects can be created by various staggers of 1, 2, or 3 corrugations. Ensure proper waterproofing by aligning the overlapping guides.



## FASTENING

ONDUVILLA® is to be fastened at each overlap and corrugation with ONDUVILLA® Fasteners. Fasten the shingles following the order described, between the 2 overlapping guides. Do not fasten those corrugations that will be overlapped by the next shingle or Verge Piece until those pieces are in place.

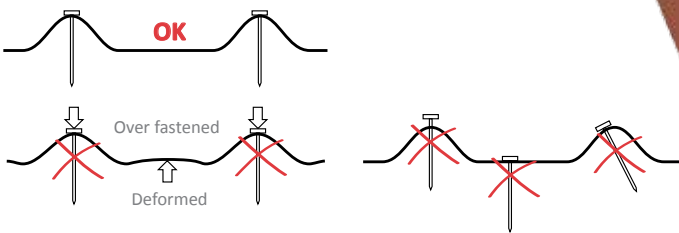
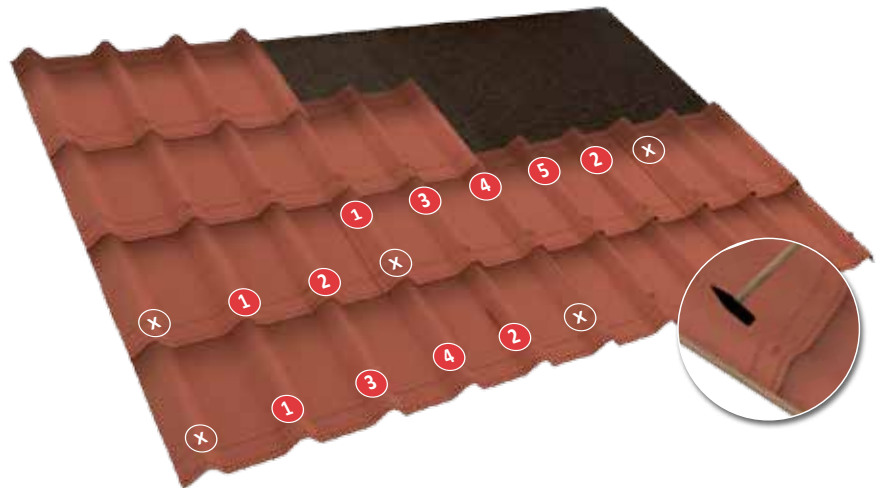

**1st Course**-Start at either rake, shingle can be installed in either direction over properly prepared and installed sheathing, underlayment, ice and water leak barrier, and edge trim. Begin by installing first full shingle. Install shingle at rake positioning so that Verge Piece aligns with first corrugation on shingle. You may need to inset shingle 1/4" to 1/2" in order to align first corrugation with Verge Piece. If necessary overhang shingle no more than 1-1/2" over eave and drip edge trim. Closure Strips should be used to close corrugations. Fasten according to the fastening pattern in the fastening schedule. On first course, fasten above the upper alignment line to ensure penetration into the roof deck. Install additional shingles along eave by overlapping one corrugation and continue following fastener schedule to the opposite rake.

**2nd course**- Stagger each course a minimum of 1 corrugation from the previous course by cutting the shingle. Preferred method is to alternate full shingle first course and half shingle second course and continue alternating pattern. Align at the rake edge as before. Align the overlapping guide with the underlying shingle and fasten according to the fastener schedule. Continue installing to the rake edge. Continue up slope with additional courses as needed. Make sure that shingles are aligned correctly and running true following the desired stagger pattern. Make sure fasteners are not over driven as it will cause the shingle to deflect and not overlap correctly.

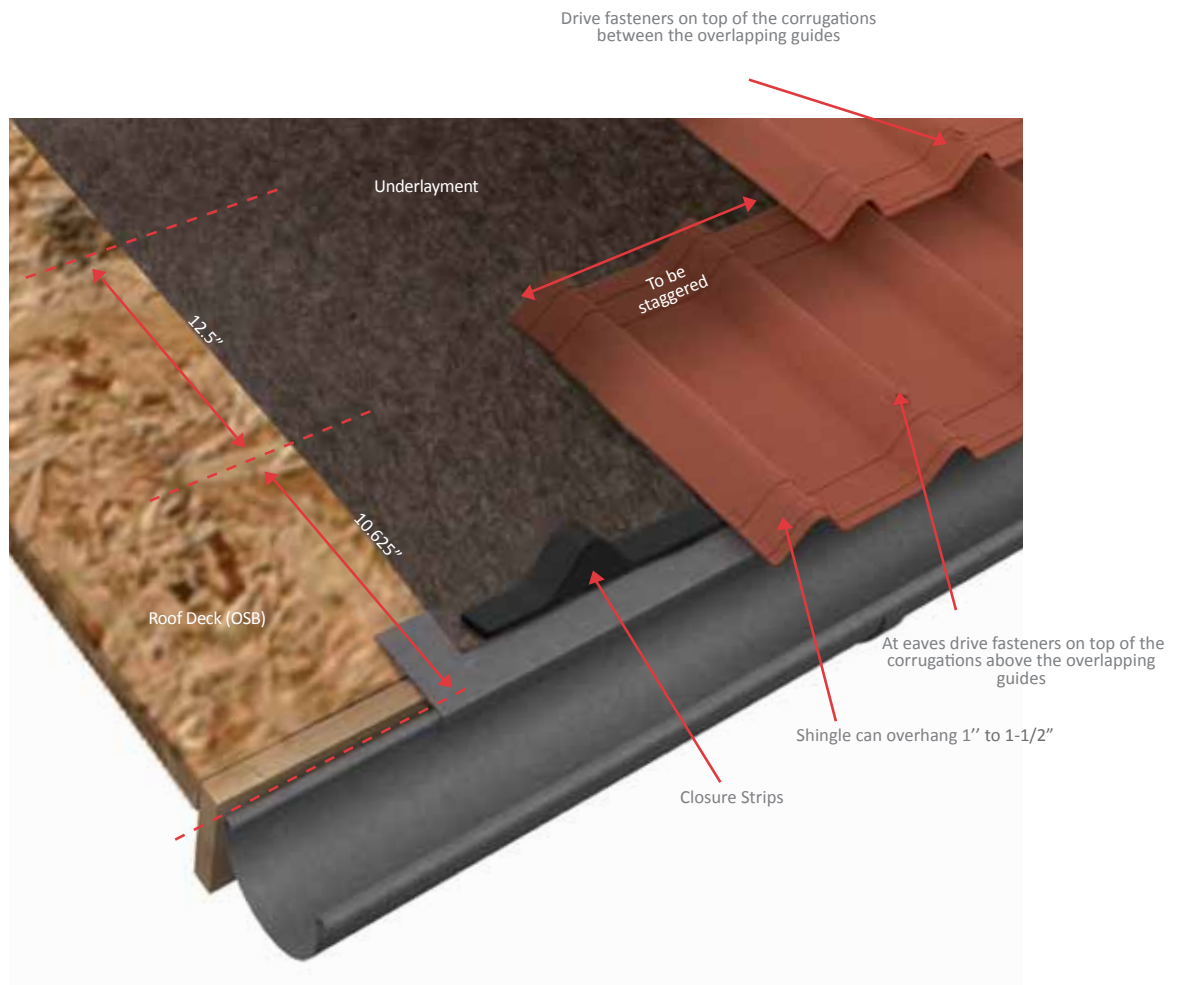

Leave a space of 1/4" between the first corrugation and the rake line in order to provide for the correct fastening of the Verge Piece. (See Verge section on page 10.)

Shingles can be temporarily fastened using blind nailing method with standard roofing nails. Nail top of shingle in flat area between alignment guides with roofing nails following alignment and overlap install guidelines. Make sure temporary fastener is flush with shingle. Install ONDUVILLA® Fasteners as recommended.

## RIDGE FOR PITCH BELOW 10/12

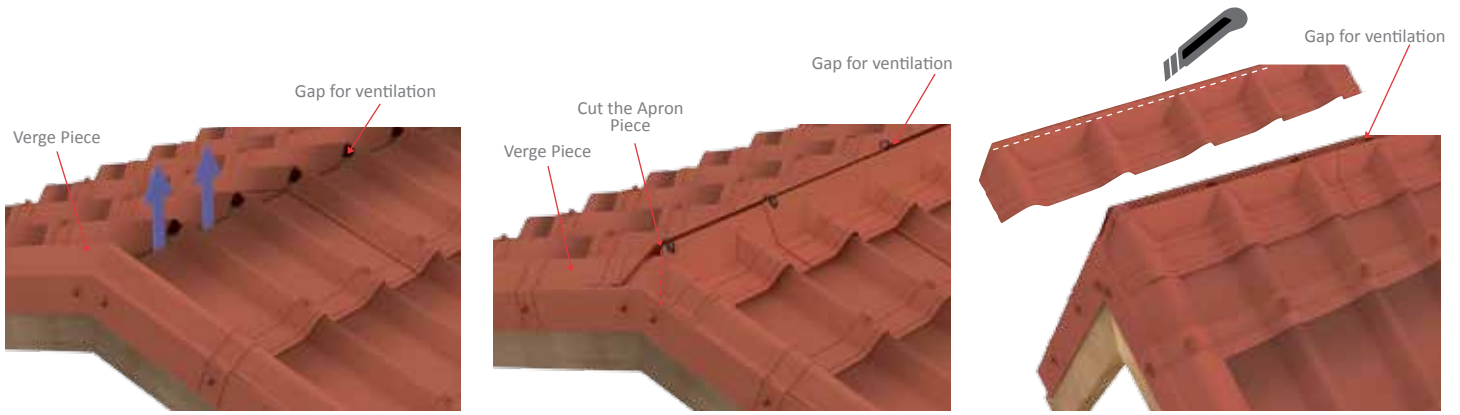

**1** Run shingles to ridge. Leave gap for ventilation if desired.

**2** The Apron Piece is installed on both sides of the roof to secure watertightness. At the verge, the Apron Piece has to be cut on site parallel to the last corrugation of the shingle.

**3** For pitches above 8/12, it is necessary to cut the flat part above the corrugations.



**4** Install Closure Strips. Install Slim Cap over Apron Piece maintaining proper overlap and fastening schedule.

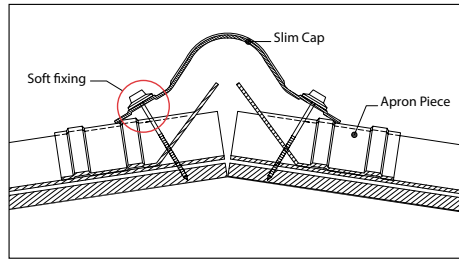

**5** At low pitches (below 4/12), soft fastening is recommended in order to avoid the possible deformation of the Slim Cap.

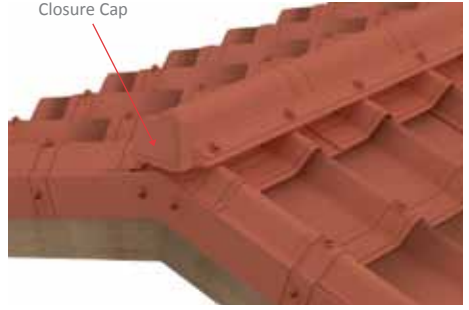

**6** Foam closures can be fastened below the ridge piece, in order to prevent birds or other animals from entering the roof space.

## RIDGE FOR PITCH ABOVE 10/12



**1** The Slim Cap can be used for pitches up to 10/12. Above that limit, the Standard Ridge piece should be used.

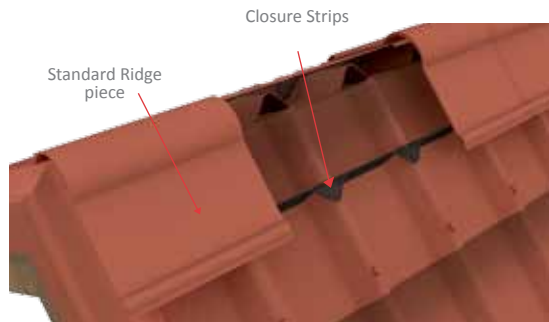

**2** Install Closure Strips. Install ridge fastening through corrugations.



- 1 Carefully cut shingles maintaining proper gap for ventilation.

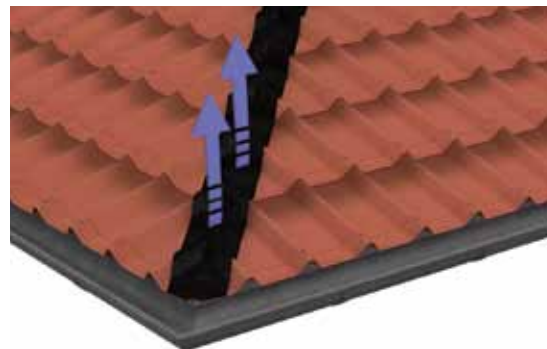

- 2 Apply Flashing Band for the first 3' of hips and then ONDULAIR SLIM membrane for rest of hip.

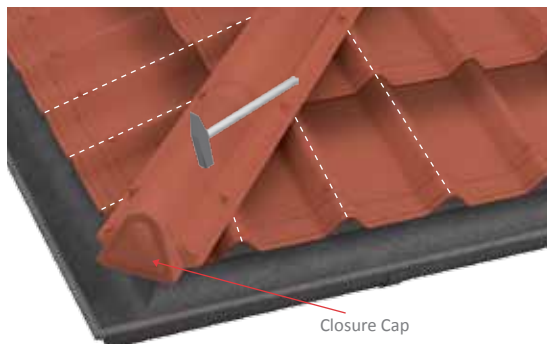

- 3 Fix the Slim Cap and Closure Cap always on top of the corrugations of ONDUVILLA® shingles. As per the ridge, soft fastening is recommended at low pitches.



**ONDULAIR SLIM**  
Perforated aluminum self-adhesive tape, which provides additional water tightness and assists in the ventilation at hips and ridges.



## VALLEY

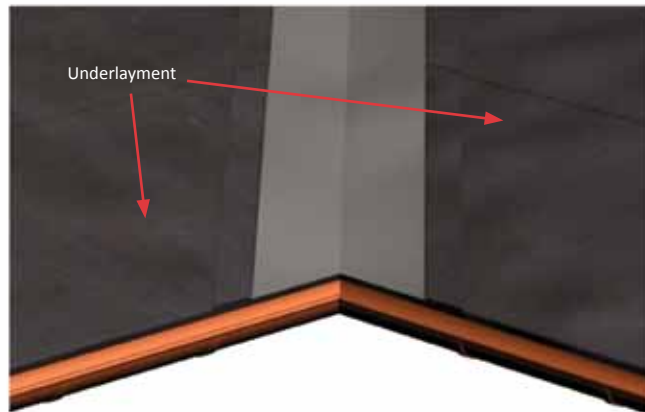
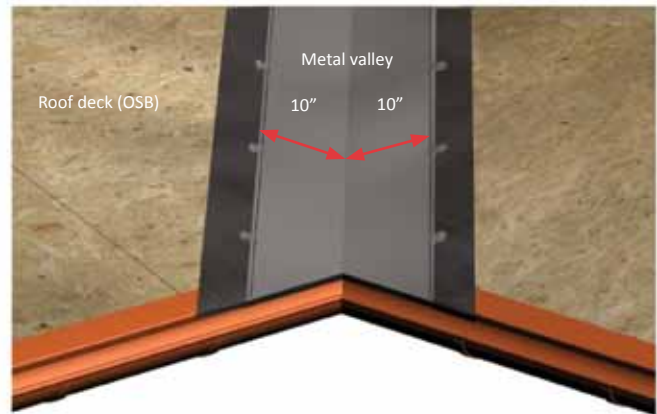

Center full width of ice and water leak barrier in valley directly over sheathing. Install a minimum of 20" wide metal valley over ice and water leak barrier in 8' to 10' sections in shingle fashion overlapping a minimum of 6". Preformed "w" style valley is preferred. Secure every 24" o.c. with cleats or large head nails. Seal nail heads with compatible sealant and run shingle underlayment. Install shingles, trimming to leave open valley. Install closure pieces to close corrugations, carefully fastening shingles to minimize penetrating metal valley.

## HIPS TO RIDGE



**1** Secure the watertightness of the detail by applying self adhesive flashing material (Flashing Band.)

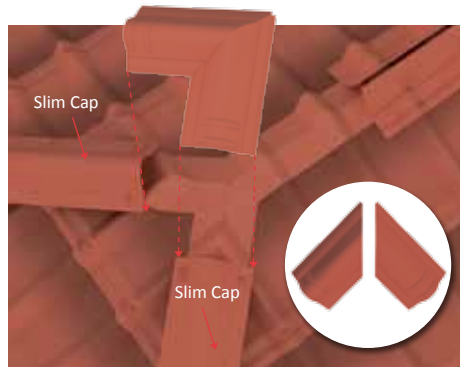

**2** Apply a module consisting of 2 Slim Cap portions (to be fastened together using Flashing Band), cutting them at the right angle in accordance with the slope of the roof.

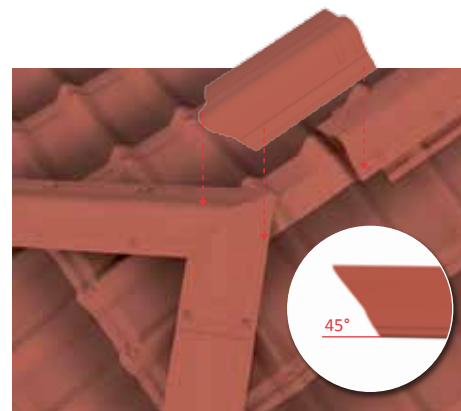

**3** Cut the Slim Cap with an angle of 45° and fasten it. The ridge piece has to overlap the hips.

## VERGE

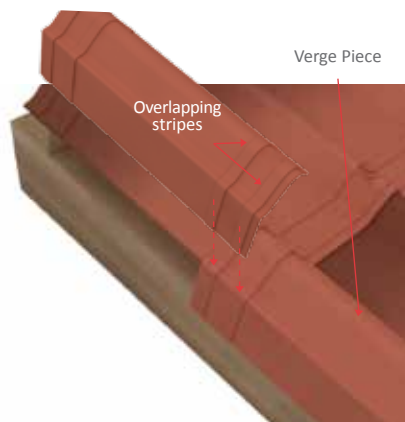

**1** At the beginning of the roof, the Verge Piece simply overlaps the first corrugation of ONDUVILLA®.



**2** In addition to the usual fastening on top of the corrugation, side fastening is also necessary to ensure against wind uplift. Side fastening comes first, then finalize with top fastening.

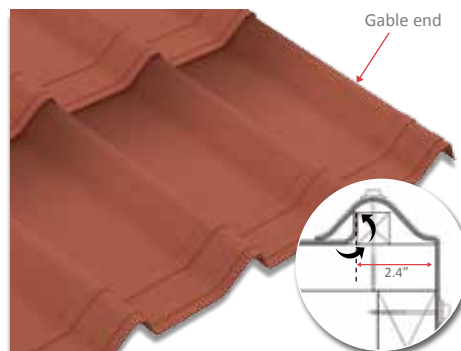

**3** On the opposite side, the roof may not end with a corrugation. Cut shingle and install a 1" x 1" batten. Bend shingle onto batten and fasten the Verge Piece through the batten.

## SIDEWALL METHOD 1

Install ice and water leak barrier directly to sheathing and 4" up sidewall. Run shingle to the sidewall and trim to fit. Install metal flashing over last corrugation and onto ice and water leak barrier on sidewall. Fasten through metal and shingle corrugation and fasten flashing to sidewall. Flash top edge of metal on sidewall with self-adhesive flashing tape making sure to correctly shingle flashing, weather resistant barrier and cladding over metal flashing.

## SIDEWALL METHOD 2

Install ice and water leak barrier to sheathing and 4" up sidewall. Install metal J channel a minimum of 4" up sidewall. Throat of metal J channel should be wide enough for last shingle corrugation to terminate into channel. Fasten through corrugation and ice and water leak barrier making sure not to fasten through metal J channel. Properly shingle metal J channel on side wall with weather resistant barrier and exterior cladding.

## HEADWALL



Run ONDUVILLA® shingles up slope to wall. Install Apron Piece on shingles at wall. Install Flashing Band and/or flashing metal, sealing top edge of Apron Piece to wall. Install wall covering over Flashing Band and top of Apron Piece.

## MONO RIDGE TO WALL

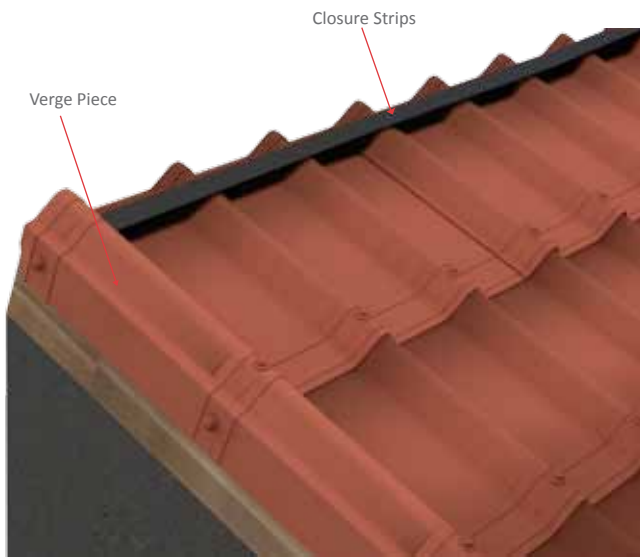

**1** Install the Verge Piece. Install Closure Strips.

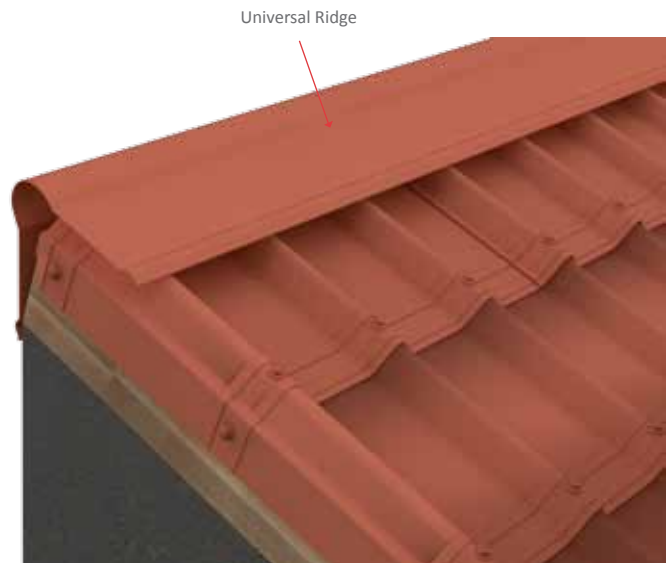

**2** Apply a Standard Ridge piece and fasten it on both sides.

## VENTILATION

All roofs require proper ventilation. This illustrates how to install a power vent.

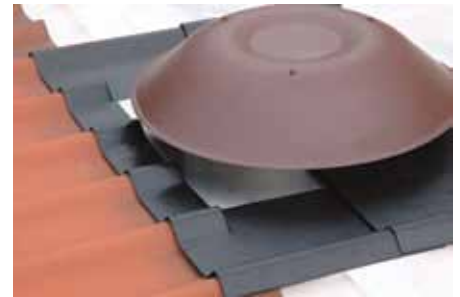
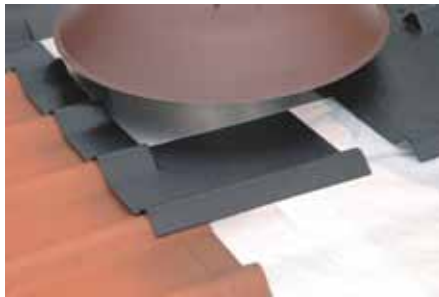
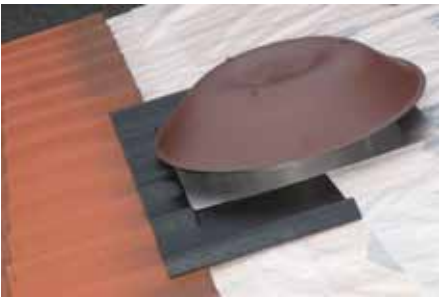
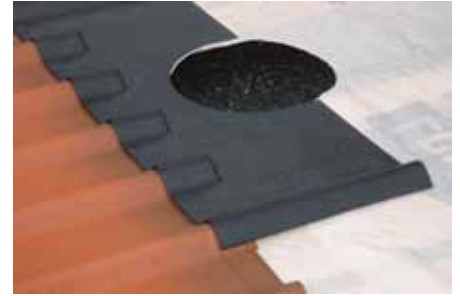
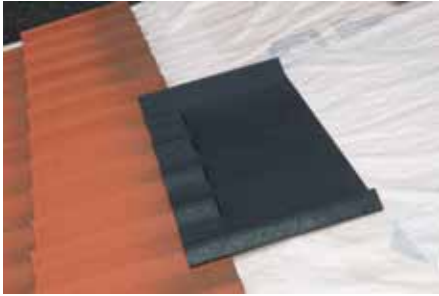

Locate and position roof vent as recommended by manufacturer. Run shingles up slope to the desired location of vent. Position ONDUVILLA® Flashing Adapter with corrugations overlapping shingle. Use vent template to mark and cut out opening for vent in sheathing and the ONDUVILLA® Flashing Adapter. Make sure flange on the vent fits on the flat area of the adapter. Install vent per manufacturer's recommendations setting vent flange in a continuous bead of compatible sealant. With vent in place, cut flat section of upper ONDUVILLA® Flashing Adapter to go around the throat of the vent. Where adapters overlap, run two parallel beads of sealant. Make sure to maintain proper overlap and alignment of adapter consistent with the shingles. Continue running shingles maintaining proper alignment and overlap.

## SPECIAL APPLICATION: ONDUVILLA® FLASHING ADAPTER

The ONDUVILLA® Flashing Adapter can be used in a variety of locations on the roof in order to provide proper water tightness. This may include chimneys, ventilators, skylights or other roof penetrations.

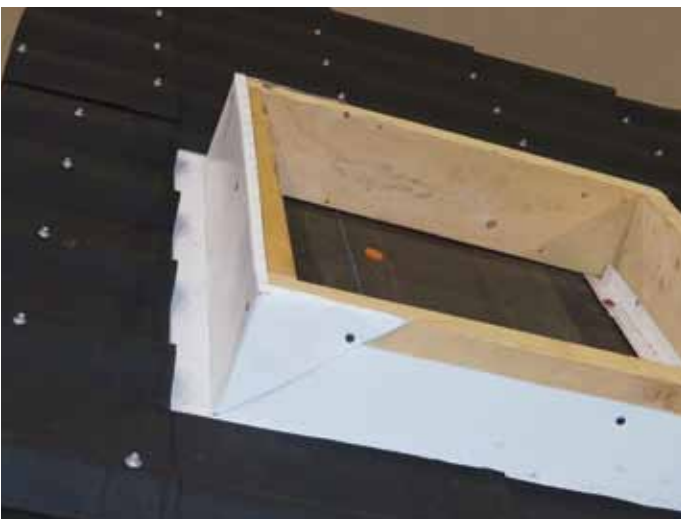
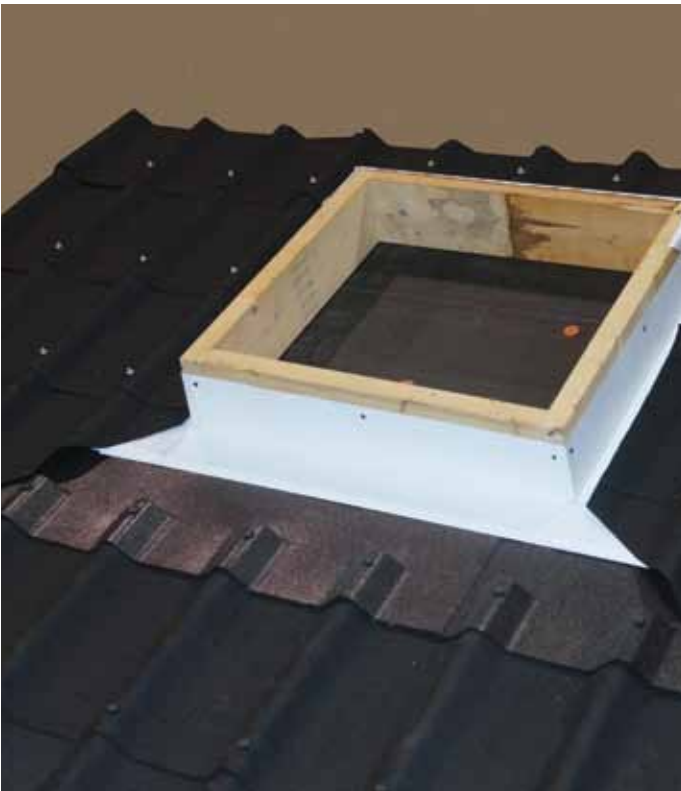

- 1 Placing adapter at base of curb, chimney, etc.**
  - A:** Install shingles up to a maximum of 1 shingle height or 16" away from the curb base.
  - B:** Place adapter so that one full corrugation is on each side of the curb.
  - C:** Notch the flat portion of the adapter in order to keep it in line with the corresponding course of shingles. If curb is wider than 1 adapter, then a combination of 2 or more can be used. One adapter can be used on curb widths of up to 18"; each additional adapter will add 24" of usable length.
- 2 Custom metal along bottom of curb and onto adapter.**
  - A:** Bend metal flashing that will provide a minimum of 4" of coverage on the deck and 4" continuing up the wall of the curb/chimney.
  - B:** Install and seal corners and areas that will be overlapped as needed.
- 3 Metal pan along sides of curb.**
  - A:** Bend custom metal pan flashing to extend up the curb a minimum of 4" (if possible 6" is recommended). Metal should have a base that allows a 1/2" return to remain vertical under the first corrugation away from the curb. This pan will run from 6" beyond the top of the curb to 4" below the bottom corner.
  - B:** Cut and bend the metal at the corners to provide a water tight seal.
  - C:** At the overlaps, a seal should be applied to provide adequate protection. This should be repeated for each side of the curb.
- 4 Install back metal pan.**
  - A:** Bend a metal pan that will correctly overlap aforementioned side pans and provide a minimum of 4" up the backside of the curb/chimney and a minimum of 12" on the deck.
  - B:** Install shingles and Closure Caps along back in such a way as to provide a minimum of 3" of non-covered flashing and a minimum of 6" clearance between fasteners and the backside of the curb/chimney.

# ONDUVILLA<sup>®</sup>, a complete roofing system

**A complete system  
for a professionally  
installed roof**

ONDUVILLA<sup>®</sup> has everything you need all in one comprehensive solution! All visible accessories are designed with **the same shingle material**, including the ridge, hip and gable end. And you can benefit from a **wide range of smart, functional accessories** to deliver a professionally installed roof.

- 1 ONDUVILLA<sup>®</sup> Shingle
- 2 ONDUVILLA<sup>®</sup> System-Approved Fastener
- 3 Verge Piece
- 4 Slim Cap
- 5 Closure Cap
- 6 Foam Closure Strip (Eaves)
- 7 Foam Closure Strip (Ridge)
- 8 Apron (Option to #7)

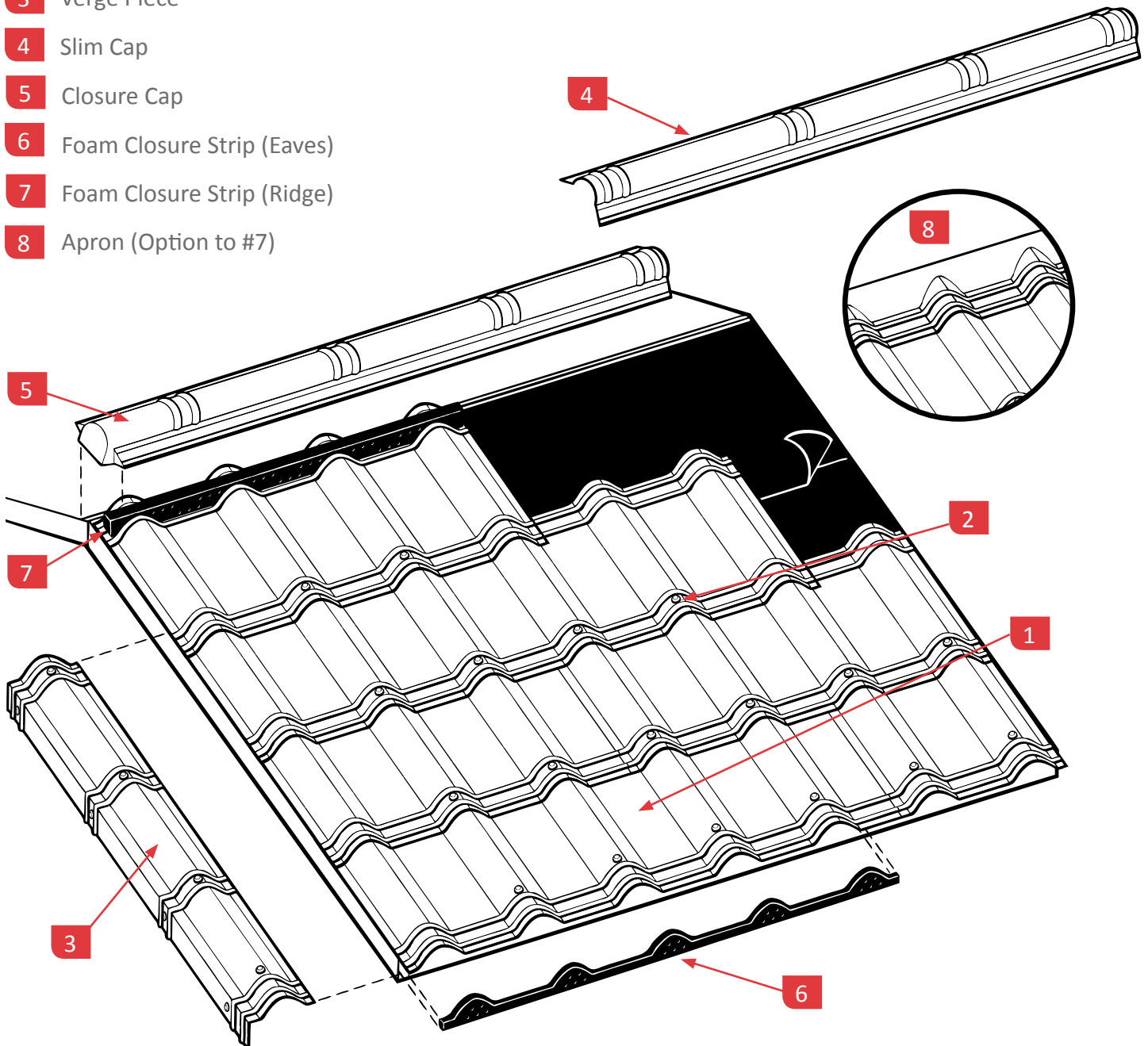

	PRODUCT	DESCRIPTION	DIMENSIONS
MOLDED ACCESSORIES	 Slim Cap	Cap for ridge and hips, for roofs with a pitch up to 10/12.	41-1/2 x 7"
	 Closure Cap	Designed for the finishing of ridge and hip lines (pitch up to 10/12).	42 x 7"
	 Apron Piece	Designed to provide watertightness and ventilation to the ridge line (Residential), for roofs with a pitch up to 8/12. Can also be used to seal the gap between ONDUVILLA® shingles and vertical wall abutment.	40-1/2 x 5-1/2"
	 Verge Piece	Designed to provide a neat weatherproof seal at the edge of the roof. Can be used for both sides right/left.	41 x 4 x 4-1/2"
OTHER ACCESSORIES	 Standard Ridge	Universal solution for ridge and hip. Does not require additional waterproofing device. (ONDULAIR SLIM or foam Closure Strips recommended.)	35-1/2 x 19-1/2"
	 ONDULAIR SLIM	Perforated aluminum self-adhesive tape, which provides additional water tightness and assists in the ventilation at hips and ridges.	6" x 16'
	 Flashing Band	Aluminum self-adhesive flashing band with butyl adhesive, used for waterproofing around chimneys, walls, skylights and other abutments or transitions. No special tools required.	98 x 11-3/4"
	 Pipe Flashing	Pipe Flashing accessory used for cold or hot pipes protruding through roof. Can be used for other roof penetrations.	19-1/2 x 25" and 26-1/2 x 33"
	 ONDUVILLA® Flashing Adapter	The ONDUVILLA® Flashing Adapter can be used in a variety of locations on the roof in order to provide proper water tightness. This may include chimneys, ventilators, skylights or other roof penetrations.	16 x 42"
	 Closure Strips	Available in two styles: Vented or solid. Solid closure strips should be used whenever a watertight seal is necessary.	38 x 1 x 1"
	 ONDUVILLA® Screws	Zinc-plated steel, Phillips head screw with EPDM washer. Color matched with ONDUVILLA colors.	2-7/8"
	 ONDUVILLA® Nails	Galvanized steel, ring-shank nail with EPDM washer. Color matched with ONDUVILLA colors.	3" and 4"

### Available in 6 designer colors



TERRACOTTA



CLASSIC RED



FOREST GREEN



SIENA BROWN



SLATE GRAY



EBONY BLACK



For more assistance with how to install an ONDUVILLA® roof, go to [onduvilla-usa.com](http://onduvilla-usa.com).



*Elevate Roofing to New Dimensions™*

4900 Ondura Drive, Fredericksburg, VA 22407

Phone: 800.777.7663 FAX: 540.898.4991

[www.onduline-usa.com](http://www.onduline-usa.com)

©2015 Onduline North America, Inc. Printed in USA K-AE263