



**PRESSURE WASHER
OPERATION MANUAL**
for model EPW2123100

Record All Information and attach sales receipt here for future reference:

Purchase Date: _____

Serial #: _____

Questions? 1-888-895-4549

Refer to the website for electronic manual and parts book.

www.powermate.com



TABLE OF CONTENTS

| | | | |
|-------------------------------------|----|---------------------------------|----|
| Safety Guidelines/Definitions | 2 | Start-Up Procedure | 11 |
| Consumer Safety Information..... | 2 | Chemical Injection..... | 11 |
| Important Safety Instructions | 2 | Cleaning Techniques | 12 |
| Safety Features | 6 | End of Cleaning Operation | 12 |
| Specifications | 6 | Maintenance..... | 13 |
| Assembly instructions | 7 | Storage..... | 14 |
| Spray Nozzle Selection..... | 9 | Warranty..... | 15 |
| Before Operation | 9 | Troubleshooting Guide | 16 |
| Engine and Pump Features | 10 | Français..... | 17 |
| Operating Connections..... | 10 | Español..... | 33 |
| Operating Instructions | 11 | | |

IMPORTANT: Please make certain that the person who is to use this equipment carefully reads and understands these instructions before operating.

SAFETY GUIDELINES - DEFINITIONS

- SAVE ALL INSTRUCTIONS

This manual contains information that is important for you to know and understand. This information relates to protecting YOUR SAFETY and PREVENTING EQUIPMENT PROBLEMS. To help you recognize this information, we use the symbols below. Please read the manual and pay attention to these symbols.

| | |
|---|--|
| <p>⚠ DANGER Indicates an imminently hazardous situation which, if not avoided, WILL result in DEATH OR SERIOUS INJURY.</p> | <p>⚠ CAUTION Indicates a potentially hazardous situation which, if not avoided, MAY result in MINOR OR MODERATE INJURY.</p> |
| <p>⚠ WARNING Indicates a potentially hazardous situation which, if not avoided, COULD result in DEATH OR SERIOUS INJURY.</p> | <p>NOTICE Indicates a potentially hazardous situation which, if not avoided, MAY result in PROPERTY DAMAGE.</p> |

CONSUMER SAFETY INSTRUCTIONS

- SAVE ALL INSTRUCTIONS

⚠ WARNING This product may not be equipped with a spark arresting muffler. If the product is not equipped and will be used around flammable materials, or on land covered with materials such as agricultural crops, forest, brush, grass, or other similar items, then an approved spark arrester must be installed and is legally required by the state of California. It is a violation of California statutes section 13005(b) and/or sections 4442 and 4443 of California Public Resources Code, unless the engine is equipped with a spark arrester, as defined in section 4442, and maintained in effective working order. Spark arresters are also required on some U.S. Forest Service land and may also be legally required under other statutes and ordinances.

⚠ WARNING CALIFORNIA PROPOSITION 65 WARNING

This product contains chemicals known to the State of California to cause cancer, birth defects and/or reproductive harm.

IMPORTANT SAFETY INSTRUCTIONS

- SAVE ALL INSTRUCTIONS

⚠ WARNING Do not operate this unit until you have read and understand this Operator's Manual and the Engine Owner's Manual for Safety, Operation, and Maintenance Instructions.

READ AND SAVE THESE INSTRUCTIONS

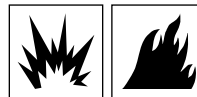

⚠ DANGER RISK OF EXPLOSION FOR FIRE

| WHAT CAN HAPPEN | HOW TO PREVENT IT |
|---|--|
| <ul style="list-style-type: none"> • Spilled gasoline and its vapors can become ignited from cigarette sparks, electrical arcing, exhaust gases and hot engine components such as the muffler. | <ul style="list-style-type: none"> • Shut off engine and allow it to cool before adding fuel to the tank. • Use care in filling tank to avoid spilling fuel. Move pressure washer away from fueling area before starting engine. |
| <ul style="list-style-type: none"> • Heat will expand fuel in the tank, which could result in spillage and possible fire explosion. | <ul style="list-style-type: none"> • Fill tank to ½" (12.7 mm) below bottom of filler neck to provide space for fuel expansion. |
| <ul style="list-style-type: none"> • Operating the pressure washer in an explosive environment could result in a fire. | <ul style="list-style-type: none"> • Operate and fuel equipment in well-ventilated areas free from obstructions. Equip areas with fire extinguisher suitable for gasoline fires. |

IMPORTANT SAFETY INSTRUCTIONS (CONT.)

- SAVE ALL INSTRUCTIONS

DANGER RISK OF EXPLOSION FOR FIRE (CONT.)

| WHAT CAN HAPPEN | HOW TO PREVENT IT |
|---|---|
| <ul style="list-style-type: none"> • Materials placed against or near the pressure washer can interfere with its proper ventilation features causing overheating and possible ignition of the materials. | <ul style="list-style-type: none"> • Never operate pressure washer in an area containing dry brush or weeds. |
| <ul style="list-style-type: none"> • Muffler exhaust heat can damage painted surfaces, melt any material sensitive to heat (such as siding, plastic, rubber, vinyl, or the pressure hose, itself), and damage live plants. | <ul style="list-style-type: none"> • Always keep pressure washer a minimum of 4' (1.2m) away from surfaces (such as houses, automobiles or live plants) that could be damaged from muffler exhaust heat. |
| <ul style="list-style-type: none"> • Improperly stored fuel could lead to accidental ignition. Fuel improperly secured could get into the hands of children or other unqualified persons. | <ul style="list-style-type: none"> • Store fuel in an OSHA-approved container, in a secure location away from work area. |
| <ul style="list-style-type: none"> • Use of acids, toxic or corrosive chemicals, poisons, insecticides, or any kind of flammable solvent with this product could result in serious injury or death. | <ul style="list-style-type: none"> • Do not spray flammable liquids. |

DANGER RISK TO BREATHING (ASPHYXIATION)



| WHAT CAN HAPPEN | HOW TO PREVENT IT |
|--|---|
| <ul style="list-style-type: none"> • Breathing exhaust fumes will cause serious injury or death! Engine exhaust contains carbon monoxide, an odorless and deadly gas. | <ul style="list-style-type: none"> • Operate pressure washer in a well-ventilated area. Avoid enclosed areas such as garages, basements, etc. • Never operate unit in a location occupied by humans or animals. |
| <ul style="list-style-type: none"> • Some cleaning fluids contain substances which could cause injury to skin, eyes or lungs. | <ul style="list-style-type: none"> • Use only cleaning fluids specifically recommended for high-pressure washers. Follow manufacturer's recommendations. Do not use chlorine bleach or any other corrosive compound. |

DANGER RISK OF FLUID INJECTION AND LACERATION



| WHAT CAN HAPPEN | HOW TO PREVENT IT |
|--|---|
| <ul style="list-style-type: none"> • Your pressure washer operates at fluid pressures and velocities high enough to penetrate human and animal flesh, which could result in amputation or other serious injury. Leaks caused by loose fittings or worn or damaged hoses can result in injection injuries. DO NOT TREAT FLUID INJECTION AS A SIMPLE CUT! See a physician immediately! | <ul style="list-style-type: none"> • Inspect the high-pressure hose regularly. Replace the hose regularly. Replace the hose immediately if it is damaged, worn, has melted from contacting the engine, or shows any signs of cracking, bubbles, pinholes, or other leakage. Never grasp a high-pressure hose that is leaking or damaged. • Never touch, grasp or attempt to cover a pinhole or similar water leak on the high-pressure hose. The stream of water IS under high pressure and WILL penetrate skin. • Never place hands in front of nozzle. • Direct spray away from self and others. • Make sure hose and fittings are tightened and in good condition. Never hold onto the hose or fittings during operation. • Do not allow hose to contact muffler. • Never attach or remove wand or hose fittings while system is pressurized. |
| <ul style="list-style-type: none"> • Injuries can result if system pressure is not reduced before attempting maintenance or disassembly. | <ul style="list-style-type: none"> • To relieve system pressure, shut off engine, turn off water supply and pull gun trigger until water stops flowing. • Use only hoses and accessories rated for pressure higher than your pressure washer's PSI. |

IMPORTANT SAFETY INSTRUCTIONS (CONT.)

• SAVE ALL INSTRUCTIONS

DANGER RISK OF INJURY FROM SPRAY



| WHAT CAN HAPPEN | HOW TO PREVENT IT |
|---|--|
| <ul style="list-style-type: none"> • High-velocity fluid spray can cause objects to break, propelling particles at high speed. • Light or unsecured objects can become hazardous projectiles. | <ul style="list-style-type: none"> • Always wear ANSI-approved z87.1 safety glasses. Wear protective clothing to protect against accidental spraying. • Never point wand at or spray people or animals. • Always secure trigger lock when wand is not in service to prevent accidental operation. • Never permanently secure trigger in pull-back (open) position. |

DANGER RISK OF FLUID INJECTION AND LACERATION



| WHAT CAN HAPPEN | HOW TO PREVENT IT |
|---|---|
| <ul style="list-style-type: none"> • Unsafe operation of your pressure washer could lead to serious injury or death to you or others. | <ul style="list-style-type: none"> • Do not use chlorine bleach or any other corrosive compound. • Become familiar with the operation and controls of the pressure washer. • Keep operating area clear of all persons, pets and obstacles. • Do not operate the product when fatigued or under the influence of alcohol or drugs. Stay alert at all times. • Never defect the safety features of this product. • Do not operate machine with missing, broken or unauthorized parts. • Never leave wand unattached while unit is running. |
| <ul style="list-style-type: none"> • If proper starting procedure is not followed, engine can kickback causing serious hand and arm injury. | <ul style="list-style-type: none"> • If engine does not start after two pulls, squeeze trigger of gun to relieve pump pressure. Pull starter cord slowly until resistance is felt. Then pull cord rapidly to avoid kickback and prevent hand or arm injury. |
| <ul style="list-style-type: none"> • The spray gun/wand is a powerful cleaning tool that could look like a toy to a child. | <ul style="list-style-type: none"> • Keep children away from the pressure washer at all times. |
| <ul style="list-style-type: none"> • Reactive force of spray will cause gun/wand to kickback, and could cause the operator to slip or fall or misdirect the spray. Improper control of gun/wand can result in injuries to self and others. | <ul style="list-style-type: none"> • Do not overreach or stand on an unstable support. • Do not use pressure washer while standing on a ladder. • Grip gun/wand firmly with both hands. Expect the gun to kickback when triggered. |

DANGER RISK OF INJURY OR PROPERTY DAMAGE WHEN TRANSPORTING OR STORING



| WHAT CAN HAPPEN | HOW TO PREVENT IT |
|--|--|
| <ul style="list-style-type: none"> • Fuel or oil leak or spill could result in fire or breathing hazard. Serious injury or death can result. Fuel or oil leaks will damage carpet, paint or other surfaces in vehicles or trailers. | <ul style="list-style-type: none"> • If pressure washer is equipped with a fuel shut-off valve, turn the valve to OFF position before transporting to avoid fuel leaks. If pressure washer is not equipped with a fuel shut-off valve, drain the fuel from tank before transporting. Only transport fuel in an OSHA-approved container. Always place pressure washer on a protective mat when transporting to protect against damage to vehicle from leaks. Remove pressure washer from vehicle immediately upon arrival at your destination. |

IMPORTANT SAFETY INSTRUCTIONS (CONT.)

• SAVE ALL INSTRUCTIONS

WARNING RISK OF HOT SURFACES



| WHAT CAN HAPPEN | HOW TO PREVENT IT |
|---|--|
| <ul style="list-style-type: none"> • Contact with hot surfaces, such as engine's exhaust components, could result in serious burn. | <ul style="list-style-type: none"> • During operation, touch only the control surfaces of the pressure washer. Keep children away from the pressure washer at all times. They may not be able to recognize the hazards of this product. |

WARNING RISK OF CHEMICAL BURN



| WHAT CAN HAPPEN | HOW TO PREVENT IT |
|---|--|
| <ul style="list-style-type: none"> • Use of acids, toxic or corrosive chemical, poisons, insecticides, or any kind of flammable solvent with this product could result in serious injury or death. | <ul style="list-style-type: none"> • Do not use acids, gasoline, kerosene, or any other flammable materials in this product. Use only household detergents, cleaners and degreasers recommended for use in pressure washers. • Wear protective clothing to protect eyes and skin from contact with spraying materials. |

WARNING RISK OF ELECTRICAL SHOCK



| WHAT CAN HAPPEN | HOW TO PREVENT IT |
|--|---|
| <ul style="list-style-type: none"> • Spray directed at electrical outlets or switches, or objects connected to an electrical circuit, could result in a fatal electric shock. | <ul style="list-style-type: none"> • Unplug any electrically operated product before attempting to clean it. Direct spray away from electric outlets and switches. |

WARNING RISK OF INJURY FROM LIFTING



| WHAT CAN HAPPEN | HOW TO PREVENT IT |
|--|--|
| <ul style="list-style-type: none"> • Serious injury can result from attempting to lift too heavy an object. | <ul style="list-style-type: none"> • The pressure washer is too heavy to be lifted by one person. Obtain assistance from others before lifting. |

SAFETY FEATURES

- SAVE ALL INSTRUCTIONS

THERMAL RELIEF VALVE

A thermal relief valve is provided to protect the pump from overheating if the spray gun is closed for an extended length of time or the nozzle becomes plugged. However, it is intended to be used as a backup system and every effort should be made to not permit the pump to heat up.

We recommend turning the pressure washer off if it will not be used for more than five minutes. This saves wear on the unit, reduces fuel consumption and extends the life of the pump by avoiding heat.

NOTICE The pump will overheat and may be damaged, or cause damage if allowed to circulate more than five minutes.

SAFETY LOCK OFF LATCH

To prevent accidental discharge of high pressure water, the safety latch on the trigger should be engaged whenever the pressure washer is not in use. (Refer to Operating Instructions.)

LOW-OIL SHUTDOWN

The unit is equipped with a low oil sensor. If the engine oil level becomes lower than required, the pressure washer will automatically shut off. (Refer to the engine manual for this feature.) This protects your pressure washer engine from operating without proper lubrication.

If the pressure washer engine shuts off and the oil level is according to specification, check to see if the pressure washer is sitting at an angle that forces oil to shift. Place on an even surface to correct this. If the engine fails to start, the oil level may not be sufficient to deactivate low oil level switch. Be sure the engine is completely full of oil. See engine manual.

SPARK ARRESTING MUFFLER

THIS PRODUCT MAY NOT BE EQUIPPED WITH A SPARK ARRESTING MUFFLER. If the product will be used around flammable materials, such as agricultural crops, forests, brush, grass, or other similar items, then an approved spark arrester should be installed and is legally required in the State of California. The California statutes requiring a spark arrester are Sections 13005(b), 4442 and 4443. Spark Arresters are also required on some U.S. Forest Service land and may also be legally required under other statutes and ordinances. For more information, contact our Customer Service Department at 1-888-895-4549.

SPECIFICATIONS

- SAVE ALL INSTRUCTIONS

| | |
|---------------------------------------|---------------|
| Maximum Pressure (PSI) | 3100 |
| Gallons Per Minute (GPM) | 2.8 |
| Maximum Inlet Pressure | Up to 90 PSIG |
| RPM | 3750 RPM |
| Temperature of Pumped Fluids. | Up to 80°F |
| Inlet Ports | 3/4" GHT (F) |
| Discharge Ports. | M22 |

Your pressure washer has a maintenance-free pump. There is no need to change the pump oil.

ASSEMBLY INSTRUCTIONS

- SAVE ALL INSTRUCTIONS

1. Place the unit on its back and insert wheel axle into front tube. Use (1) M6 washer and (1) M6 x 15mm long hex head screw to assemble wheel axle to frame using the supplied open-end wrench. Tighten securely. Repeat for opposite side.

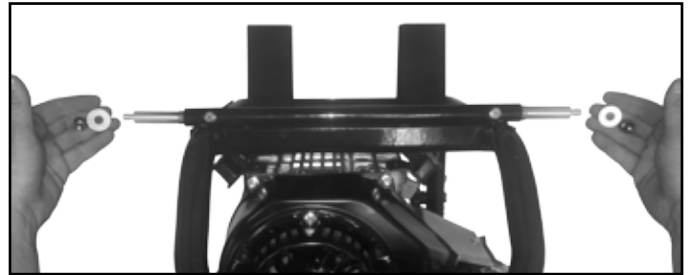

2. Remove (1) M8 washer and (1) M8 nut from wheel axle and place wheel onto axle. Be sure the hub on the wheel goes to the inside. Re-assemble the washer and nut onto axle using the supplied open-end wrench. Tighten securely. Repeat for opposite side.



3. With the unit still on its back, assemble the rubber feet using (1) M8 x 30mm long socket head cap screw and (1) M8 nut. Using the supplied hex wrench and open-end wrench, tighten securely. Repeat for opposite side.

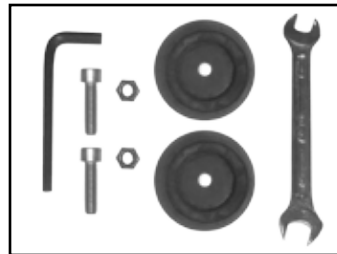

4. Place the unit on its wheels and rubber feet. Remove the knobs and screws from the handle.

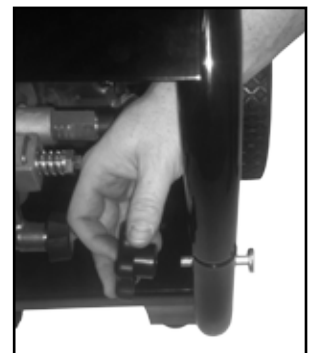
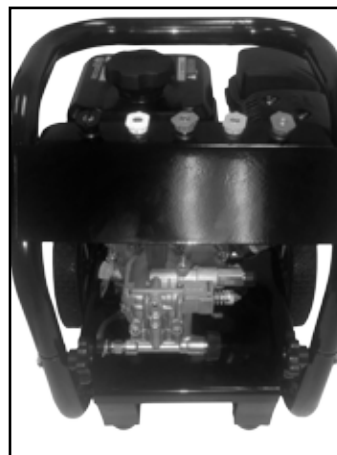

ASSEMBLY INSTRUCTIONS (continued)

- SAVE ALL INSTRUCTIONS

4. Remove the handle and rotate 180 degrees and re-insert into the frame. Re-assemble both knobs and screws.



5. Assemble the lower gun hook using (1) M6 x 45mm long socket head cap screw, (1) M6 nut, and the supplied hex wrench and open-end wrench. Tighten securely.

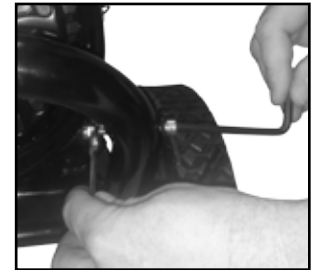
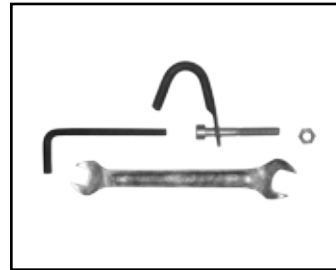

6. Assemble the upper gun hook using (1) M6 x 45mm long socket head cap screw, (1) M6 nut, and the supplied hex wrench and open-end wrench. Tighten securely.

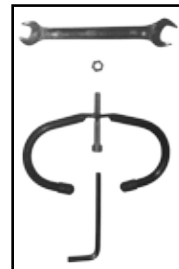

7. Assemble the upper hose hanger using (2) M6 x 45mm long socket head cap screws, (2) M6 nuts, and the supplied hex wrench and open-end wrench. Tighten securely.

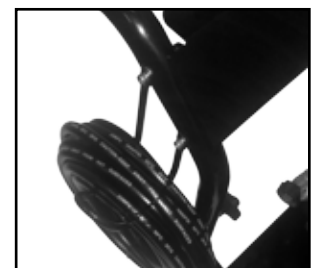
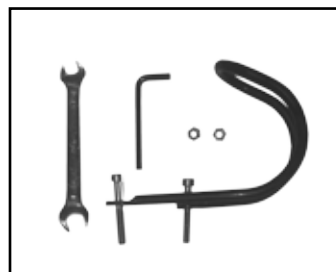

SPRAY NOZZLE SELECTION

• SAVE ALL INSTRUCTIONS

Following is information concerning the five nozzles provided with your pressure washer.

NOTE: The force of the spray on the surface you are cleaning increases as you move closer to the surface.

0° High Pressure (Red): The water stream discharged is very aggressive. Use with extreme caution to prevent damage to the surface being cleaned or injury to persons or animals.

15° High Pressure (Yellow): This is the nozzle used for most cleaning applications. It provides narrow coverage and a highly powerful water stream.

25° High Pressure (Green): Use of this nozzle offer both a medium coverage and water stream. Best used for flushing dirt and debris off surfaces.

40° High Pressure (White): This nozzle is chemical injector to apply chemicals used for cleaning with the widest coverage over a larger area with a powerful water stream.

65° Low Pressure (Black): Provides low pressure spray and a wide coverage. Used primarily when operating the chemical injector to apply chemicals.

BEFORE OPERATION

• SAVE ALL INSTRUCTIONS

NOTE: The engine and pump on your EXCELL™ Pressure Washer will often have improved performance after a break-in period of several hours.

PRE-START PREPARATION

Before starting the pressure washer, check for loose or missing parts and for any damage which may have occurred during shipment.

HOSE AND GUN ASSEMBLY

NOTE: Align threaded connections carefully to prevent damaging threads during assembly. Tighten connections securely to prevent leaks during operation.

Attach the hose to the inlet of the trigger gun.

LUBRICATION

DO NOT attempt to start the pressure washer engine without filling the engine crank case with the proper amount and type of oil. (See the accompanying engine manual for this information.) Your pressure washer engine has been shipped from the factory without oil in the engine crankcase. Operating the unit without oil will ruin the engine.

The pump is not equipped with a dipstick or sight glass windows. Check oil leaks from the pump. Pump oil is shipped in the pump from factory.

FUEL

Fill the tank with clean, fresh unleaded automotive gasoline. (See Figure 1). Regular grade gasoline may be used provided a high octane rating is obtained (at least 85 pump octane).

⚠ WARNING Gasoline is very dangerous. Serious injury may result from fire caused by gasoline contacting hot surfaces.

Do not overfill the tank. Keep maximum fuel level 1/2 inch below the bottom of the filler neck. This will allow expansion in hot weather and prevent overflow.

ENGINE AND PUMP FEATURES - FIGURE 1

• SAVE ALL INSTRUCTIONS

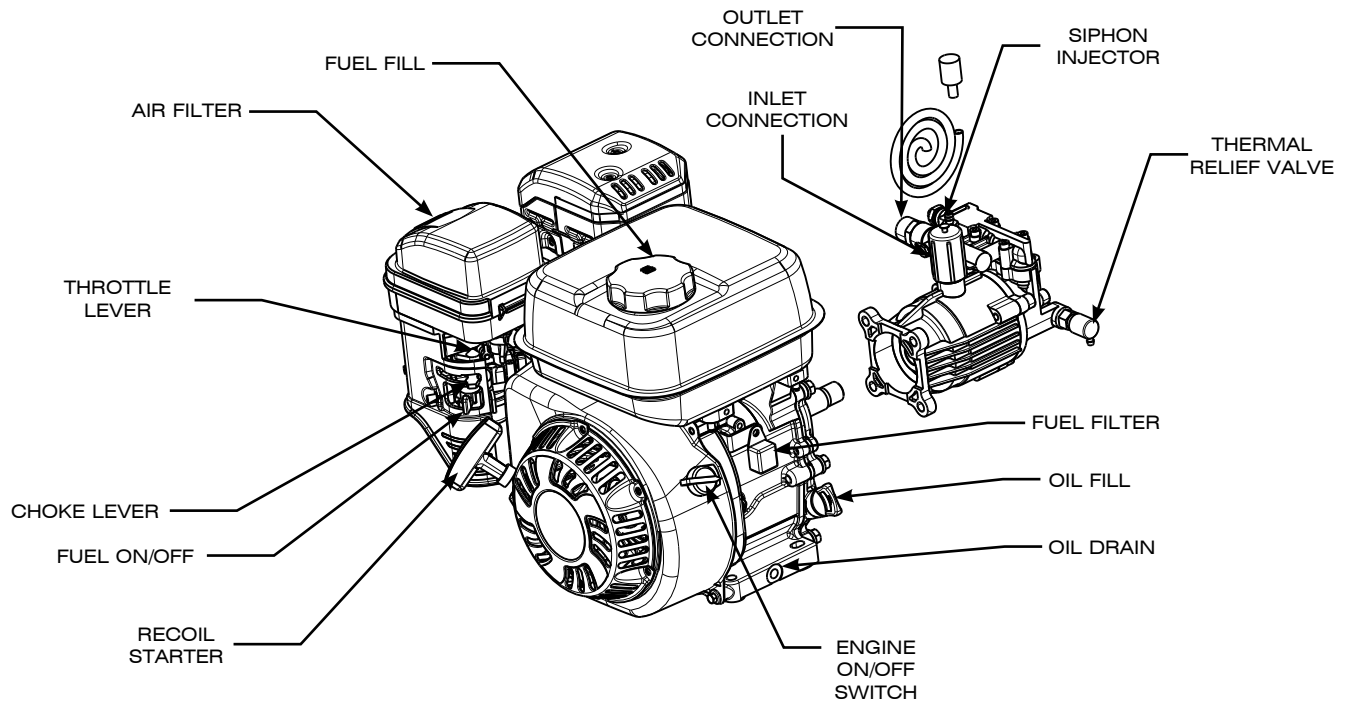

OPERATING CONNECTIONS

• SAVE ALL INSTRUCTIONS

HIGH PRESSURE HOSE

Attach the high pressure hose to the outlet connection located on the pump. (See Figure 1).

WATER CONNECTION

Before connecting to unit, run water through the garden hose (not supplied) to flush out any foreign matter. Check that the screen is clean and is in the inlet of the pump. Attach garden hose to the inlet connection located on the pump. (See Figure 1).

NOTE: The water supply must provide a minimum of 4 GPM at 40 to 80 PSI or the pump will be damaged.

OPERATING INSTRUCTIONS

- SAVE ALL INSTRUCTIONS
-

START-UP PROCEDURE

1. Ensure water supply is connected and turned on.
2. Release gun safety lock.
3. To allow air to escape from the hose, squeeze trigger on the gun until there is a steady stream of water coming from the nozzle.
4. Remove any dirt or foreign matter from the gun outlet and the male connector of the wand.
5. Insert the nozzle wand into the gun wand and tighten the twistfast fitting securely by hand.

STARTING THE ENGINE (See Figure 1, page 10)

1. Check oil and fuel level.
2. Adjust choke as necessary.
3. Set the engine switch to the "ON" position.
4. Squeeze trigger on pressure washer to release pressure while pulling on the engine starter rope with a fast steady pull. Pressure may otherwise build up making starting the unit difficult.
5. As the engine warms up, open the choke to full.

⚠ WARNING If the wand or nozzle is not securely locked into place, it could be ejected under high pressure when operating the gun, possibly causing injury or damage.

CHEMICAL INJECTION

- SAVE ALL INSTRUCTIONS
-

1. Ensure that one end of the chemical injection tube is attached to the siphon injector on the pump (see Figure 1, page 10)
2. Ensure that the other end of the chemical injection tube is attached to the nipple on the bottom of the chemical tank
3. Fill your chemical tank with your cleaner of choice (most cleaners are concentrated, please follow the mixing instructions as outlined by the manufacturer of the cleaner).
4. Install the black quick connect, low pressure nozzle on the spray wand. The solution will automatically be mixed with the water and discharged through the nozzle.

NOTICE This pressure washer is intended for use only with liquid car wash detergents, developed specifically for pressure washer and with mild soaps. Only use chemicals compatible with the aluminum and brass parts of the pressure washer. Powdered soaps may clog the injection system. Always use chemicals according to manufacturer directions. MAT Industries, LLC assumes no responsibility for any damages caused by chemicals injected through this pressure washer.

CLEANING TECHNIQUES

- SAVE ALL INSTRUCTIONS
-

When cleaning with the pressure washer, many cleaning tasks can be solved with water alone, but for most tasks it is advantageous to use a detergent also. A detergent ensures a quick soaking of the dirt allowing the high pressure water to penetrate and remove the dirt more effectively.

Pressure washer chemicals are specially formulated to be used with your pressure washer.

APPLICATION OF SOAP OR DEGREASER

1. Apply the solution to a DRY work surface. On a vertical surface, apply horizontally from side to side starting from the bottom to avoid streaking.

NOTE: Wetting the surface first is not recommended, as it dilutes the detergent and reduces its cleaning ability. Avoid working on hot surfaces or in direct sunlight to minimize the chances of the chemical damaging painted surfaces. Damage may occur to painted surface if chemical is allowed to dry on the surface. Hold nozzle far enough away from surface to prevent damage to the surface.

END OF CLEANING OPERATION

- SAVE ALL INSTRUCTIONS
-

When you have completed use of the chemical injection system, remove tube from container. Continue to run in low pressure position and inject clean water through the tube and injection system by placing end of tube in a container of clean water. Continue to run until it is thoroughly cleaned.

2. Allow chemical to remain on the surface for a short time before rinsing.
3. Rinse with clean water under high pressure. On a vertical surface, first rinse from the bottom up, then rinse from the top down. Hold nozzle 6 to 8 inches from the work surface at a 45° angle using the flat spray as a peeling tool rather than a scrub brush.

APPLICATION OF WAX

1. Immediately after cleaning, apply pressure washer wax. Place injection tube in container of wax.
2. Apply the wax sparingly in an even layer. Apply to wet surfaces from the bottom up for even distribution and to avoid streaking.
3. Remove the suction tube from the wax bottle and rinse off the surplus wax.

NOTE: IF SURPLUS WAX IS NOT REMOVED, A HAZY FINISH MAY RESULT.

4. Wipe dry to reduce water spotting.

MAINTENANCE

- SAVE ALL INSTRUCTIONS
-

CONNECTIONS

Connections on pressure washer hoses, gun and spray wand should be cleaned regularly and lubricated with silicon grease to prevent leakage and damage to the o-rings.

NOZZLE

Clogging of the nozzle causes the pump pressure to be too high and cleaning is immediately required.

⚠ WARNING A nozzle cleaner must only be used when the spray nozzle is disconnected from the gun or personal injury could result.

1. Remove the nozzle from the wand.
2. Clear the nozzle with the nozzle cleaner pin provided with the pressure washer.
3. Flush the nozzle backwards with water.
4. Re-install the nozzle into the wand.

Restart the pressure washer and depress the trigger on the spray gun. If the nozzle is still plugged or partially plugged, repeat above items 1-4.

If the previous procedure does not clear the nozzle, replace with a new nozzle.

WATER SCREEN

The pressure washer is equipped with a water inlet screen to protect the pump. If the screen is not kept clean, it will restrict the flow of water to the pressure washer and may cause damage to the pump. Do not damage the screen while removing or cleaning screen. Any foreign particles entering the pump may damage the pump. Do not operate pressure washer without the screen in place.

Remove the screen and back flush to remove impurities from screen. Replace immediately.

ENGINE MAINTENANCE

During the winter months, rare atmospheric conditions may develop which will cause an icing condition in the carburetor. If this develops, the engine may run rough, lose power, and may stall.

NOTE: Refer to the engine manufacturer's manual for service and maintenance of the engine.

STORAGE

- SAVE ALL INSTRUCTIONS
-

PUMP STORAGE

If you must store your pressure washer in a location where the temperature is below 32°F, you can minimize the chance of damage to your machine by utilizing the following procedure:

1. Shut off water supply and relieve pressure in the spray gun by depressing the trigger. Disconnect the garden hose from the pressure washer, but leave the high-pressure hose connected.
2. Tip the unit on its side with the inlet connection pointing up.
3. Insert a small funnel (to prevent spilling) into the inlet and pour in approximately 1/4 cup of RV antifreeze.
4. Disconnect spark plug wire.
5. Without connecting garden hose pull the recoil several times to circulate the anti freeze in the pump system. Continue to add antifreeze and pull the recoil until the antifreeze is expelled when the trigger is pulled.
6. Turn the unit upright.

NOTICE Prior to restarting, thaw out any possible ice from the pressure washer hoses, spray gun and wand.

Another method of reducing risks of freeze damage is to drain your pressure washer as follow:

1. Stop the pressure washer and detach supply hose and high pressure hose. Squeeze the trigger of the discharge gun to drain all water from the wand and hose.
2. Restart the pressure washer and let it run briefly (about 5 seconds) until water no longer discharges from the high pressure outlet.

ENGINE STORAGE

When the pressure washer is not being operated or is being stored more than one month, follow these instructions:

1. Replenish engine oil to upper level.
2. Drain gasoline from fuel tank, fuel line, fuel valve and carburetor.
3. Pour about one teaspoon of engine oil through the spark plug hole, pull the recoil starter several times and replace the plug. Then pull the starter slowly until you feel increased pressure which indicates the piston is on its compression stroke and leave it in that position. This closes both the intake and exhaust valves to prevent the inside of the cylinder from rusting.
4. Cover the pressure washer and store in a clean, dry place that is well ventilated away from open flame or sparks.

NOTE: We recommend always using a fuel stabilizer. A fuel stabilizer will minimize the formulation of fuel gum deposits during storage. The fuel stabilizer can be added to the gasoline in the fuel tank, or into the gasoline in a storage container.

LIMITED WARRANTY

• SAVE ALL INSTRUCTIONS

Always specify model number when contacting the manufacturer.

We reserve the right to amend these specifications at any time without notice. The only warranty applicable is our standard written warranty. We make no other warranty, expressed or implied. MAT Industries, LLC warrants this pressure washer and any parts thereof, to be free from defects in material and workmanship for two (2) years (90 days for commercial use or for reconditioned unit) from the date of first purchase from an authorized dealer, provided that the product has been properly maintained and operated in accordance with all applicable instructions. This warranty is extended to the original retail purchaser. The bill of sale or proof of purchase must be presented at the time a claim is made under this warranty. This warranty does not cover industrial or rental usage, nor does it apply to parts that are not in original condition because of normal wear and tear, or parts that fail or become damaged as a result of misuse, accident, lack of proper maintenance, tampering, or alteration. Exceptions to this standard warranty period would be normal wear items such as air filters and spark plugs which are covered for sixty (60) days against defects in material and workmanship. Travel, handling, transportation, and incidental costs associated with warranty repairs are not reimbursable under this warranty and are the responsibility of the owner. To the full extent allowed by the law of the jurisdiction that governs the sale of the product, this express warranty excludes any and all other expressed warranties and limits the duration of any and all implied warranties, including warranties of merchantability and fitness for a particular purpose to two (2) years from the date of first purchase, and MAT Industries, LLC's liability is hereby limited to the purchase price of the product and MAT Industries, LLC shall not be liable for any other damages whatsoever including direct, incidental, or consequential damages. Some states do not allow limitation of how long an implied warranty lasts or an exclusion or limitation of incidental or consequential damages, so the above limitation of damages may not apply to you. This warranty provides the original purchaser with specific rights.

For information regarding those rights, please consult the applicable state laws.

MAT Industries, LLC Corporate Office – CORRESPONDENCE ONLY

ATTN: Technical Services – MIND

6700 Wildlife Way

Long Grove, IL

60047

The Engine Emissions Control System Warranty is provided by the engine manufacturer, included with this product and administered by MAT Industries, LLC.

If you have any questions regarding your warranty coverage, you should contact MIND customer service:



If you need assistance or have any questions,
CALL TOLL FREE: 1-888-895-4549

TROUBLESHOOTING GUIDE

• SAVE ALL INSTRUCTIONS

| Problem | Cause | Correction |
|---|--|--|
| Engine will not start or stops while operating | <ol style="list-style-type: none"> 1. Low-oil shutdown. 2. Engine switch not in the "ON" position. 3. Pressure build up in hose. | <ol style="list-style-type: none"> 1. Fill engine with oil. 2. Turn switch "ON". 3. Squeeze trigger. |
| Engine is overloaded | <ol style="list-style-type: none"> 1. Nozzle partially blocked. | <ol style="list-style-type: none"> 1. Clean nozzle. |
| Water or oil leaking from bottom of pump | <ol style="list-style-type: none"> 1. A small amount of leakage is normal. | <ol style="list-style-type: none"> 1. If excessive leaking occurs call the Customer Service Department. |
| Pressure increases when gun is closed | <ol style="list-style-type: none"> 1. Bypass valve not operating properly. | <ol style="list-style-type: none"> 1. Call the Customer Service Department. |
| Engine running but pump not building maximum pressure or has irregular pressure | <ol style="list-style-type: none"> 1. Faucet closed. 2. Unit has been stored in freezing temperatures. 3. Inadequate water supply. 4. Water inlet screen clogged. 5. Kink in garden hose. 6. Wand nozzle worn or damaged. 7. Air in pump. 8. Suction or discharge valves clogged or worn out. 9. By-pass valve not operating effectively. | <ol style="list-style-type: none"> 1. Open faucet. 2. Thaw out unit completely including hose, gun and wand. 3. Provide a minimum of 4 gpm at 20 psi. 4. Clean screen. 5. Straighten hose. 6. Replace nozzle. 7. Let run with gun open and wand removed until steady stream of water is released. 8. Call the Customer Service Department. 9. Call the Customer Service Department. |
| No intake of chemicals | <ol style="list-style-type: none"> 1. Injection tube not securely inserted into unit. 2. Tube cracked or split. 3. Wrong nozzle. 4. Injection tube strainer clogged. 5. Nozzle blocked. 6. Dried chemicals in injector. | <ol style="list-style-type: none"> 1. Push firmly into injector. 2. Replace tubing. 3. Switch to low pressure nozzle. 4. Clean strainer. 5. Clean nozzle. 6. Dissolve by running warm water through the injection tube. |
| Trigger will not move | <ol style="list-style-type: none"> 1. Gun safety lock engaged. | <ol style="list-style-type: none"> 1. Release safety lock. |
| Water in crankcase | <ol style="list-style-type: none"> 1. High humidity. 2. Worn seals. | <ol style="list-style-type: none"> 1. Change oil more frequently. 2. Call the Customer Service Department. |
| Noisy operation | <ol style="list-style-type: none"> 1. Worn bearings 2. Air mixed with water. | <ol style="list-style-type: none"> 1. Call the Customer Service Department. 2. Check inlet lines for restrictions and /or proper sizing. |
| Rough/pulsating operation with pressure drop | <ol style="list-style-type: none"> 1. Worn packing. 2. Inlet restriction. 3. Unloader. 4. Air mixed in water. | <ol style="list-style-type: none"> 1. Call the Customer Service Department. 2. Check system for stoppage, air leaks. correctly sized inlet plumbing to pump. 3. Check unloader for proper operation. 4. Check inlet lines for restrictions and/or proper sizing. |
| High crankcase temperatures | <ol style="list-style-type: none"> 1. Wrong grade of oil. 2. Improper amount of oil in crankcase. | <ol style="list-style-type: none"> 1. Use recommended oil. 2. Adjust oil level to proper amount. |