



Item #000  
Model #FP-51186D

# USE AND CARE GUIDE

---

## Cast Iron Outdoor Chiminea

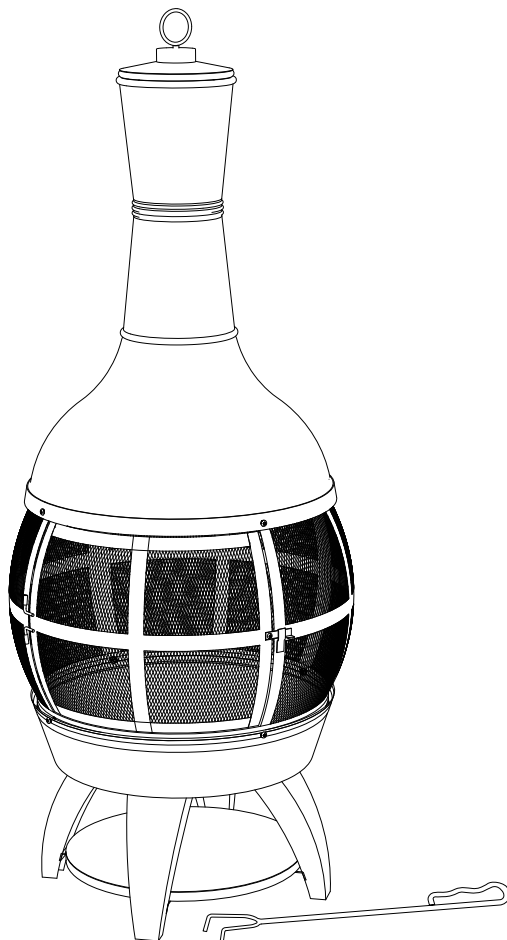

Questions, problems, missing parts? Before returning to the store,  
call Hampton Bay Customer Service  
8 a.m. - 6 p.m., EST, Monday-Friday  
9 a.m. - 6 p.m., EST, Saturday  
**1-855-HD-HAMPTON**

**HAMPTONBAY.COM**

---

### **THANK YOU**

*We appreciate the trust and confidence you have placed in Hampton Bay through the purchase of this fire pit. We strive to continually create quality products designed to enhance your home. Visit us online to see our full line of products available for your home improvement needs. Thank you for choosing Hampton Bay!*

# Table of Contents

Table of Contents .....	2	Hardware Included .....	3
Safety Information.....	2	Package Contents.....	4
Warranty .....	3	Assembly.....	5
What is Covered.....	3	Maintenance .....	9
What is Not Covered .....	3	Care and Cleaning .....	9
Pre-Assembly.....	3	Service Parts .....	10
Planning Assembly.....	3		
Tools Required .....	3		

# Safety Information

**PLEASE READ AND UNDERSTAND THIS ENTIRE MANUAL BEFORE ATTEMPTING TO ASSEMBLE, OPERATE OR INSTALL THE PRODUCT.**



**WARNING: FOR OUTDOOR USE ONLY!  
NEVER LEAVE A FIRE UNATTENDED!**



**WARNING: DO NOT USE THE FIRE PIT TO  
COOK FOOD! The fire pit is not designed  
for grilling food.**



**WARNING: DO NOT allow children or pets  
near fire pit without supervision.**



**WARNING: DO NOT touch the surface of  
the fire pit while in use as it may cause  
burns.**



**WARNING: NEVER burn in vehicles, tents  
or indoors. CARBON MONOXIDE HAZARD.**



**WARNING: Use a poker and/ or heat-  
resistant gloves to open/close the mesh  
cover while in use.**



**WARNING: DO NOT use water to  
extinguish as this is dangerous and can  
cause damage to the fire pit.**



**CAUTION: Burn only untreated wood or fire  
logs in this fire pit.**



**CAUTION: DO NOT use gasoline or kerosene  
to start the fire in this fire pit.**



**CAUTION: DO NOT use this unit on a wood  
deck, long or dry grass and/or leaves, or on  
combustible surfaces.**



**CAUTION: DO NOT attempt to move the fire  
pit while it is hot or in use.**



**CAUTION: Place the fire pit no closer than  
8 ft. from walls or combustibles during use.**



**CAUTION: Adequate fire extinguishing  
material should be readily available.**



**CAUTION: Always ensure that the mesh  
cover is secured over the fire bowl while in  
use.**



**CAUTION: The poker handle may become  
hot during and after use.**

**PROPOSITION 65 WARNING:** Fuel used in wood and charcoal burning appliances and the combustible products of such fuels contain chemicals known to cause cancer, birth defects or other reproductive harm.

Consumers should check state, provincial, and local codes and regulations regarding the use of the product.

# Warranty

## 1 YEAR LIMITED WARRANTY

### WHAT IS COVERED

We warrant the metal frame to be free of manufacturing defects to the original purchaser for one year.

### WHAT IS NOT COVERED

It remains the customer's responsibility for freight and packaging charge to and from our service center. This warranty does not cover commercial use, hardware, acts of nature, fire, freezing and abusive use. In addition, purchased parts are not covered under this warranty. We reserve the right to make substitutions with similar merchandise, if the model in question is no longer in production.

Contact the Customer Service Team at 1-855-HD-HAMPTON or visit [www.hamptonbay.com](http://www.hamptonbay.com).

# Pre-Assembly

## PLANNING ASSEMBLY

Carefully remove all pieces from carton and make sure that you have all parts (refer to parts list). If you are missing parts, please contact 1-855-HD-HAMPTON for further assistance.



**NOTE:** Please read and understand the entire manual before you assemble, operate or install the fire pit.

## TOOLS REQUIRED

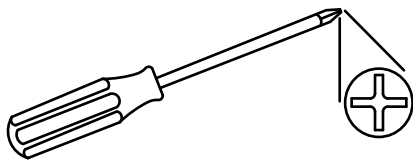

Phillips  
screwdriver

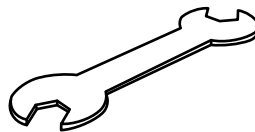

M6 Wrench

## HARDWARE INCLUDED



**NOTE:** Hardware not shown to actual size.

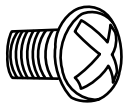

AA

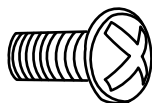

BB

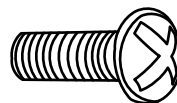

CC



DD

Part	Description	Quantity
AA	M6 x 10 mm Bolt	7
BB	M6 x 12 mm Bolt	8
CC	M6 x 25 mm Bolt	8
DD	M6 Nut	9

# Pre-Assembly (continued)

## PACKAGE CONTENTS

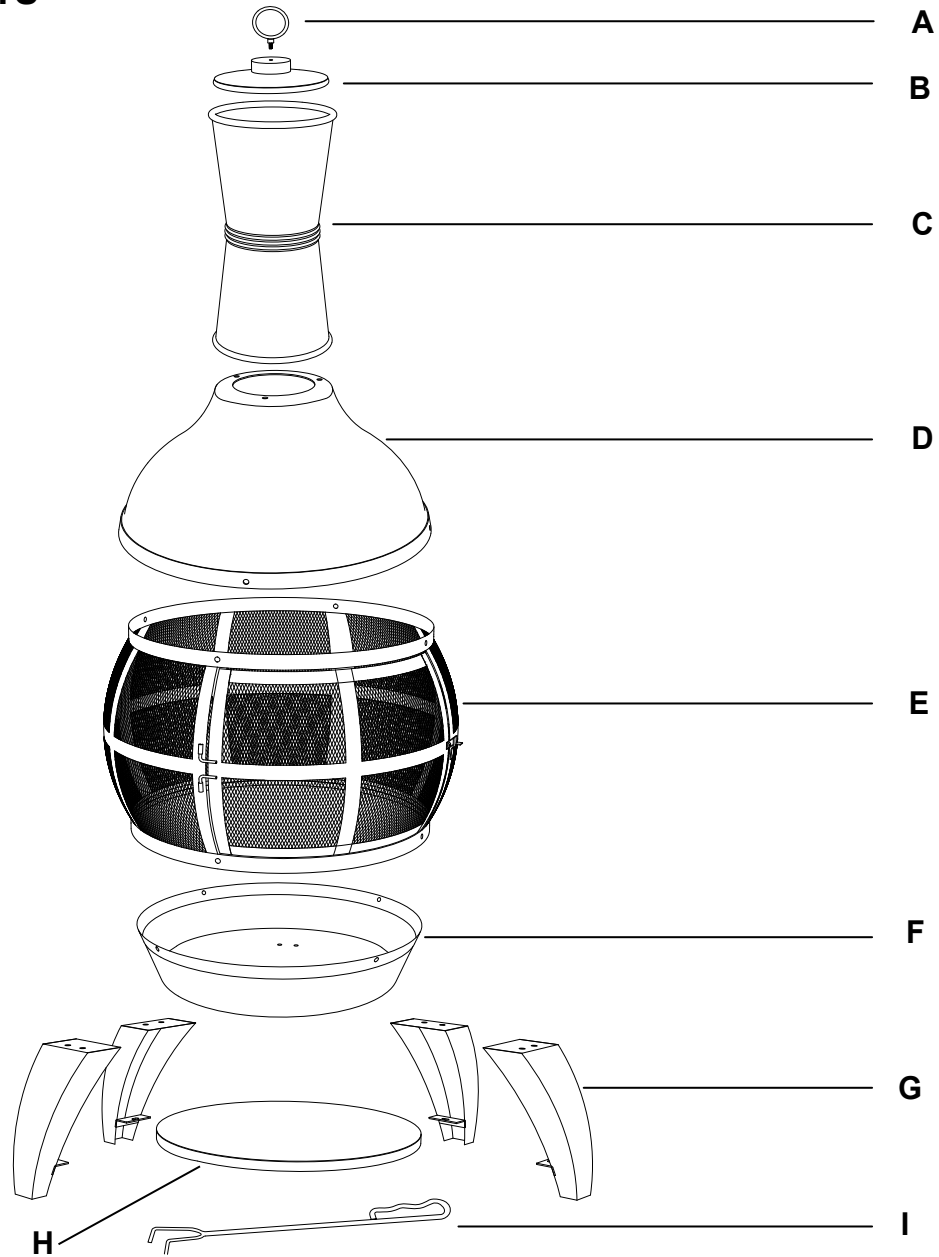

Part	Description	Quantity
A	Handle	1
B	Chimney Cover	1
C	Chimney Flue	1
D	Chimney Top	1
E	Mesh Screen	1
F	Chimney Bottom	1
G	Stand	4
H	Tray	1
I	Poker	1

# Assembly

## 1 Assembling the mesh cover

- Insert the handle (A) into the hole of the chimney cover (B).
- Attach the handle (A) to the chimney cover (B) using a nut (DD). Securely tighten with an M6 wrench (not included).



**CAUTION:**  
Wear gloves during assembly.

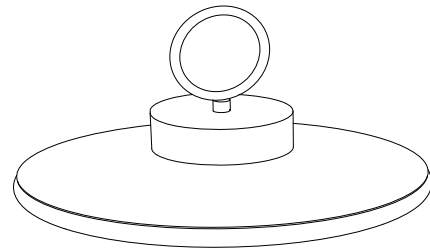
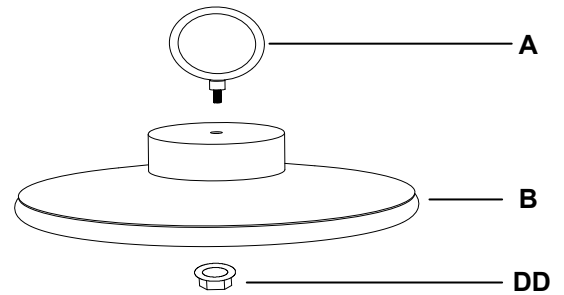

## 2 Assembling the stand

- Attach the stands (G) to the tray (H) using M6 x 10 mm bolts (AA).
- Hand tighten the bolts (AA). Do not over-tighten.

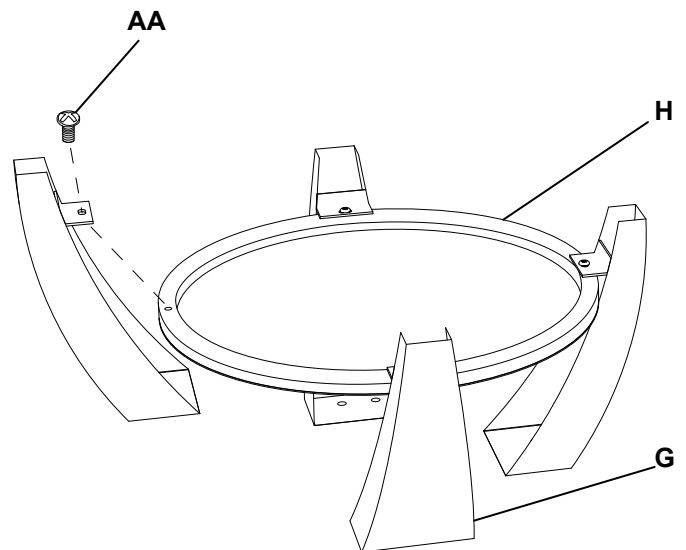

## Assembly (continued)

### 3 Attaching the chimney bottom

- Attach the chimney bottom (F) to the stand (G) using M6 x 12 mm bolts (BB).
- Securely tighten each bolt (BB) with a Philips screwdriver (not included).

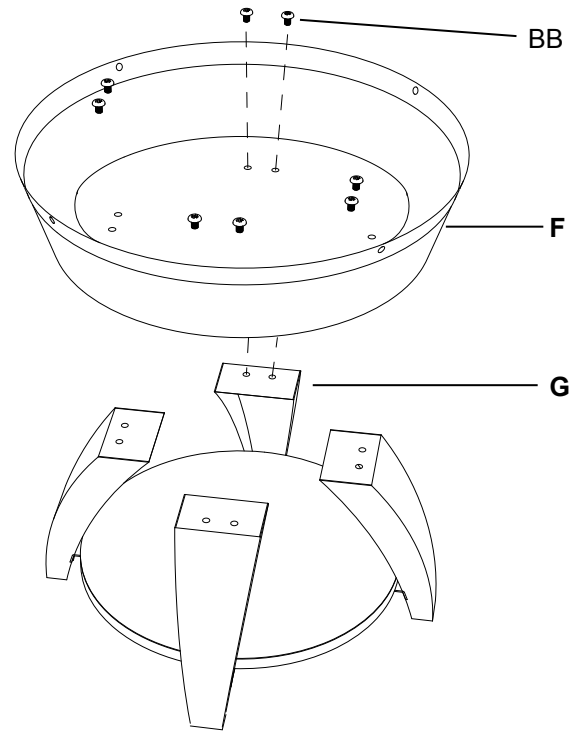

### 4 Attaching the mesh screen

- Attach the mesh screen (E) to chimney bottom (F) using M6 x 25 mm bolts (CC) and M6 nuts (DD).
- Securely tighten each bolt (CC) and nut (DD) with an M6 wrench and Philips screwdriver (not included).

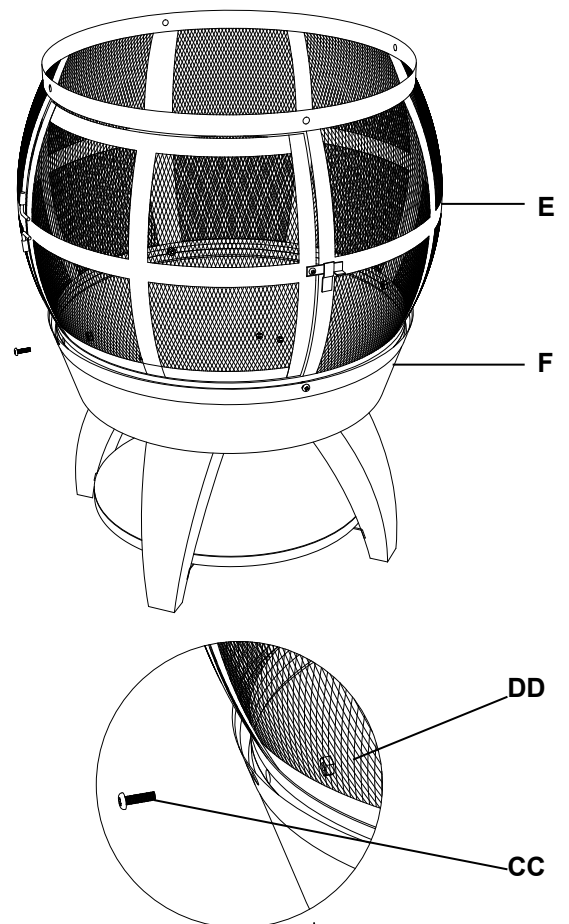

## Assembly (continued)

### 5 Attaching the chimney top

- Attach the chimney top (D) to the chimney flue (C) using M6 x 10 mm bolts (AA).
- Securely tighten each bolt (AA) with a Philips screwdriver (not included).

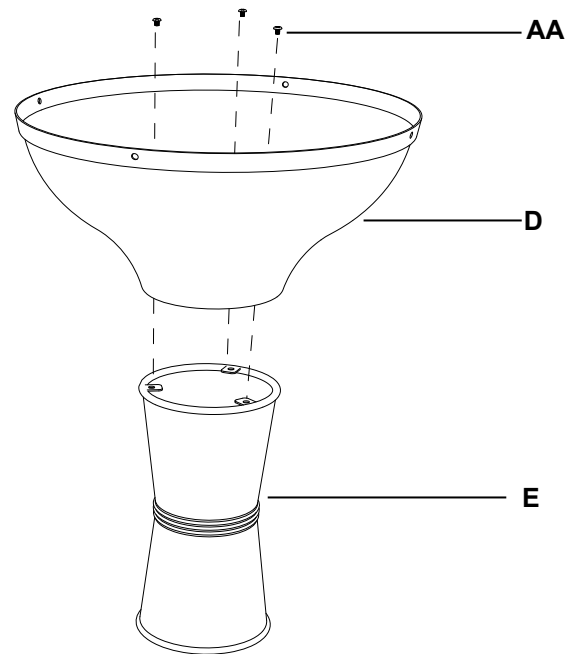

### 6 Attaching the chimney flue

- Attach the chimney top (D) to the mesh screen (E) using M6 x 25 mm bolts (CC) and M6 nuts (DD).
- Securely tighten each bolt (CC) and nut (DD) with an M6 wrench and Philips screwdriver (not included).

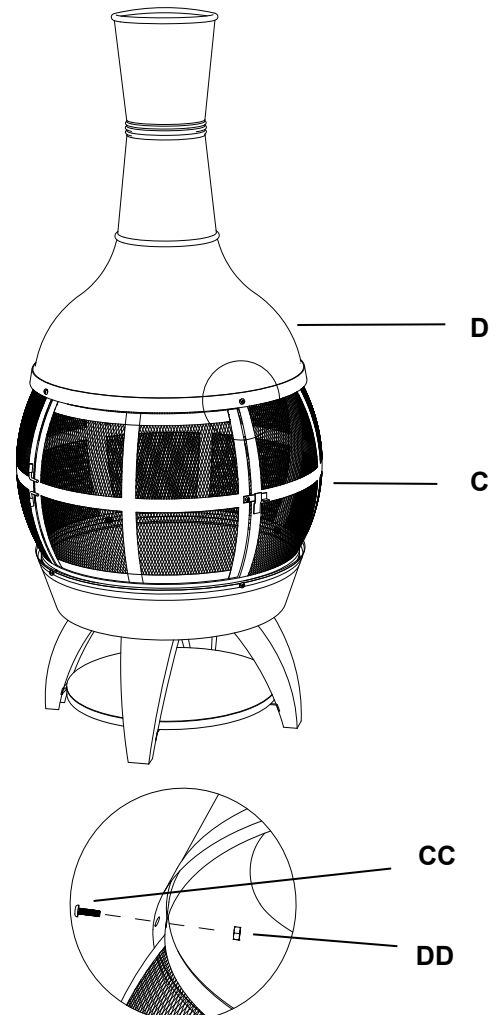

## Assembly (continued)

### 7 Completing the assembly

- Place the poker (I) near the chimney and the chimney cover (B) on the top of the assembly.

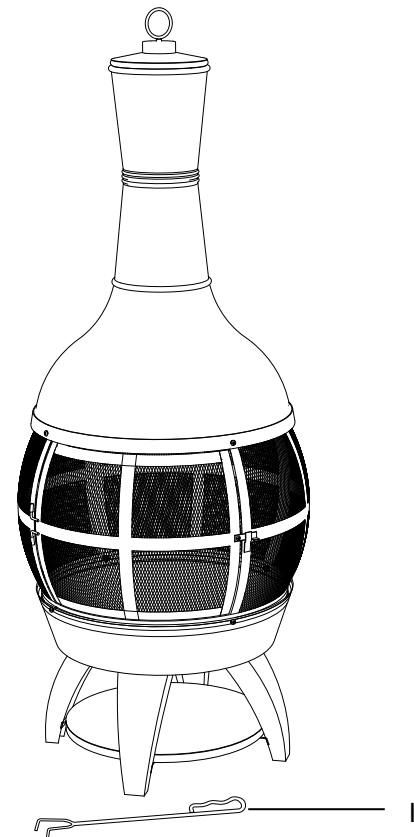
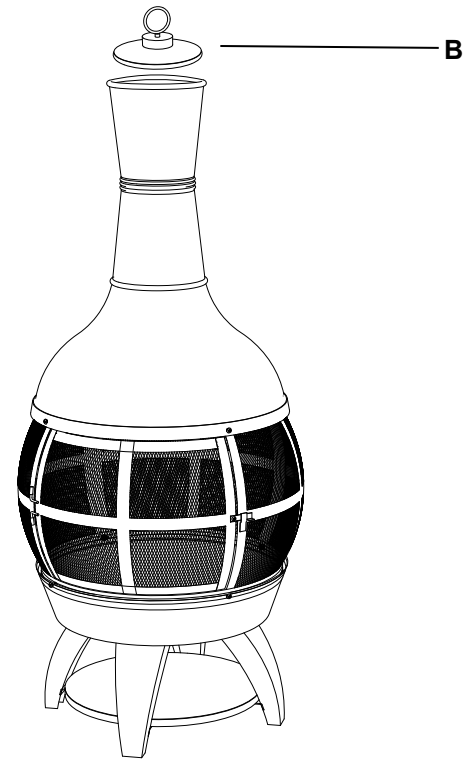



## Maintenance

---

- To extend the life of your fire pit, clean it after each use.
- To protect fire pit finish, use a soft cloth in lieu of bare hands while handling.
- Clean the fire bowl after each use once ashes have cooled.
- Store assembled in a cool, dry location away from children and pets.

## Care and Cleaning

---

- Do not attempt to clean the fire pit until the fire is completely out and cooled completely.
- Use a soft cloth to wipe the fire pit and poker.
- Do not attempt to clean while hot.
- Keep the fire pit covered when cooled and not in use.

# Service Parts

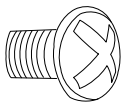
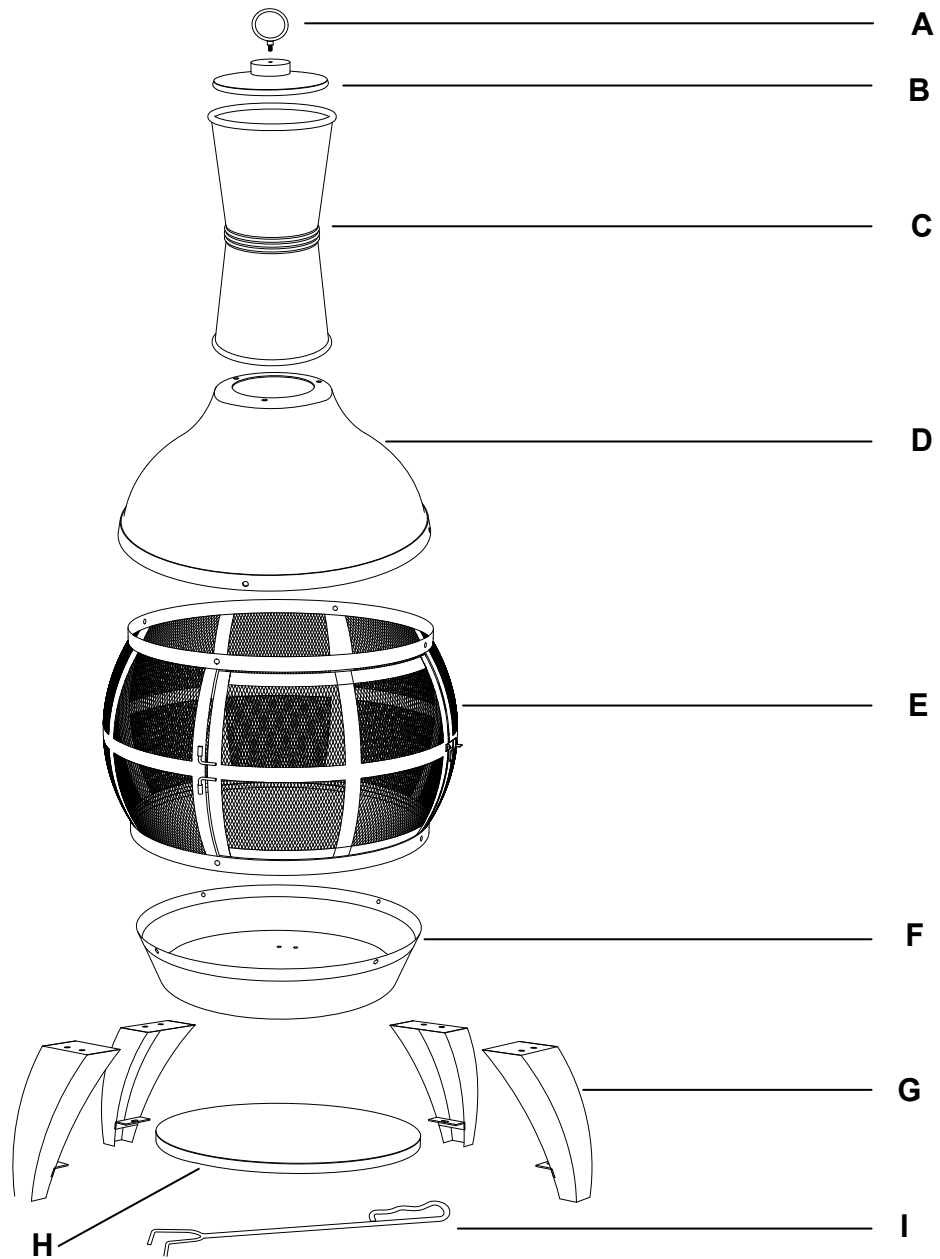

AA

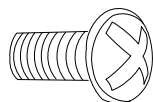

BB

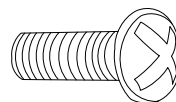

CC

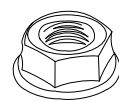

DD

Part	Description	Quantity
A	Handle	1
B	Chimney Cover	1
C	Chimney Flue	1
D	Chimney Top	1
E	Mesh Screen	1
F	Chimney Bottom	1
G	Stand	4

Part	Description	Quantity
H	Tray	1
I	Poker	1
AA	M6 x 10 mm Bolt	7
BB	M6 x 12 mm Bolt	8
CC	M6 x 25 mm Bolt	8
DD	M6 Nut	9



Questions, problems, missing parts? Before returning to the store,  
call Hampton Bay Customer Service  
8 a.m. - 6 p.m., EST, Monday-Friday  
9 a.m. - 6 p.m., EST, Saturday

**1-855-HD-HAMPTON**

**HAMPTONBAY.COM**

Retain this manual for future use.