



**THE LEADER IN
ON-SITE,
SAFETY AND
TRUCK
STORAGE
FOR SECURITY,
STRENGTH
& DURABILITY**



JOBBOX

PREMIUM STORAGE SOLUTIONS



JOBBOX

PREMIUM STORAGE SOLUTIONS

**For additional information,
check out our website at**

JOBBOX.com

TABLE OF CONTENTS

On-Site Storage Solutions 2

Premium Features	3
Slope Lid Chest.....	4
Heavy-Duty Chests	5
High Capacity Drop-Front Chest	6
Heavy-Duty Lifting Chest	7
Lifting Piano Box.....	8
Piano Boxes	9
High Capacity Piano Box.....	10
Drop-Front Piano Box	11
Field Office	12
Heavy Equipment Box.....	13
Drawer Cabinet.....	14
Rolling Clam-Shell Cabinet.....	15
Heavy-Duty Cabinet.....	16
Extra Heavy-Duty Bin Cabinets.....	17
Rolling Workbenches	18
Welder's Box & Small Chests	19
On-Site Storage Accessories	20

Safety Storage Solutions 21

Safety Checklist.....	23
Premium Features	23
Heavy Duty Safety Cabinets	24
Self-Closing Safety Cabinets	26
Storage Cans	28

Truck Storage Solutions 29

Features	30
Crossovers	32
Innersides	40
Crossover Fitment Charts	44
Topsides.....	48
Chests.....	50
Underbeds	53
Trailer Tongue Boxes.....	58
Drawer Storage.....	60
Liquid Transfer Tanks.....	62

KargoMaster® Ladder Racks 65

Rack Accessories.....	67
How to Measure Your Truck	68

At JOBOX we understand the importance of protecting your equipment.

Whether it's protection from theft, shelter from the elements, or improved on-site safety, JOBOX on-site and truck storage solutions offer superior strength, security, and durability. We utilize innovative design, in-depth research, cutting-edge technology, and extensive testing to continually improve the performance and value of our products.

JOBOX On-Site Storage Solutions provide premium protection for valuable tools and equipment with features like our Site-Vault™ Security System, EZ-Loader® Skid Bolsters, Staked and Welded Hinges, and Heavily Reinforced Lids.

JOBOX Truck Storage Boxes offer ultimate security with our Self-Adjusting Dual Rotary GearLock II™ Latching Mechanism, RSL® Beveled Edge Lids, and Industrial-Grade Steel Hinges.

JOBOX Flammable Storage Cabinets and Cans add improved safety and superior heat and fire resistance to legendary JOBOX quality, security, and durability with innovative features like EZ-Level™ Bolsters, Bright White Cabinet Interiors, Anti-Tip Bolster Design, and Fork Lift Capability.



ON-SITE STORAGE

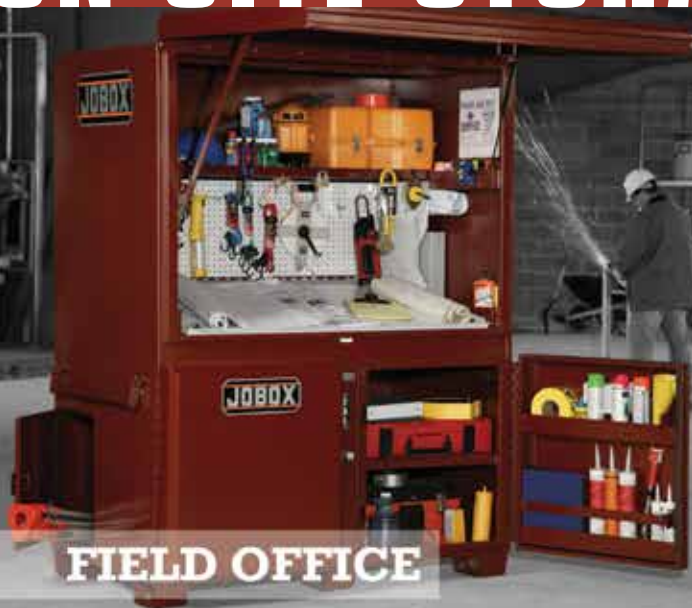

FIELD OFFICE



DROP FRONT CHEST



PIANO BOX



HEAVY EQUIPMENT BOX



STORAGE CABINET

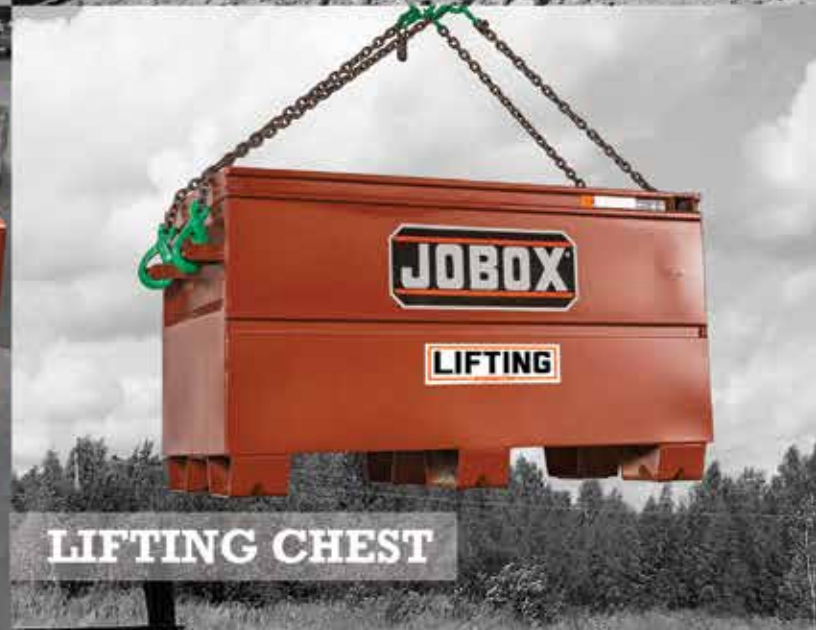

LIFTING CHEST

JOBBOX ON-SITE STORAGE >>>>

JOBBOX gives your valuable tools and equipment the ultimate on-the-job site protection from weather and theft.

EZ-LOADER[®] SKID BOLSTERS



- Patent-Pending Bolsters provide time-saving and safety features
- Easily load or unload from any side on trucks, trailers, or docks
- One-piece 7-Gauge Steel Skid Bolsters reinforce the bottom of the box for heavier loads and to protect from drops

STAKED & WELDED HINGES



- 14-Gauge Steel
- High Security, 3/8" Continuous Hinge with 1/4" steel pin and extra-large 1" knuckles
- Pin cannot be driven out

HEAVILY REINFORCED LID



- Full-Length "A-Frame" Lid Bolster
- Resists bending from cargo placed on top of the box and from attempted break-ins

OPTIONAL CASTERS



- Casters provide added mobility
- Set includes one pair each of fixed and swiveling casters

RECESSED HANDLES



- Extra tall and deep recess areas prevent pinched fingers and damage to the handle
- Allows easy storage with handles out of the way.

SITE-VAULT[™] SECURITY SYSTEM



- Patented System has Full-Length Steel Lock Console with Three Locking Points
- Formed Lid Sides Welded to Lid Bolsters Resist Pry Bar Entry
- Padlock installs inside fully-welded 14-Gauge Steel Housing
- Fluorescent Reflective Orange Tape indicates when Chest is unlocked

GRIP-RITE[™] LIFTING CHANNEL



- Formed and Welded Channel increases door or lid strength
- Provides safe, easy to grip channel for lifting lid or pulling door

GAS SPRINGS GUARDS



- Protect Gas Springs from Damage and Jamming
- Heavy duty gas springs help lift and control lid, improves safety

TEXTURED POWDER PAINT FINISH











- High-Quality Powder Paint improves durability over liquid paint
- 8 Color Options Available [Min. Order Quantity Required]

10x	5x	2x	2x
corrosion resistance	abrasion resistance	chip resistance	scratch resistance









SLOPE LID CHEST

Hold your morning meetings around the JOBOX Slope Lid Chest. The locking lid makes the perfect surface for working on plans and laptops on the job site. Also includes the popular Lift-N-Stow shelf for more storage choices.

-  EZ-Loader® Skid Bolsters
-  Staked & Welded Hinge
-  Heavily Reinforced Lid
-  Holes to Install Optional Casters
-  Site-Vault™ Security System
-  Grip-Rite™ Lifting Channel
-  Recessed Handles
-  Textured Powder Paint Finish
-  Gas-Spring Guards



Catalog No.	Length	Width	Height	Shipping Cu. Ft.	Approx. Shipping Wt.
1-680990	60 in	30 in	39.5 in	45.5 ft³	243 lb

-  EZ-Loader® Skid Bolsters
-  Site-Vault™ Security System
-  Staked & Welded Hinge
-  Grip-Rite™ Lifting Channel
-  Heavily Reinforced Lid
-  Recessed Handles
-  Holes to Install Optional Casters
-  Textured Powder Paint Finish
-  Gas-Spring Guards

[View Casters on p.20](#)

HEAVY-DUTY CHESTS









The toughest chests in the world. Designed for premium access, weather resistance, and security, the JOBOX Chest yields a plethora of features including four-way skid bolsters, and a visual, three-point locking system.



Catalog No.	Description	Length	Width	Height	Shipping Cu. Ft.	Approx. Shipping Wt.
1-652990	36" Long	36 in	20 in	23.75 in	10 ft ³	98 lb
1-653990	42" Long	42 in	20 in	23.75 in	13.8 ft ³	118 lb
1-654990	48" Long	48 in	24 in	27.75 in	22.3 ft ³	148 lb
1-655990D	60" Long	60 in	24 in	27.75 in	27.3 ft ³	182 lb
1-656990	48" Long	48 in	30 in	33.38 in	33.3 ft ³	190 lb
1-658990	72" Long	72 in	24 in	27.75 in	30.9 ft ³	203 lb

HIGH-CAPACITY DROP-FRONT CHEST





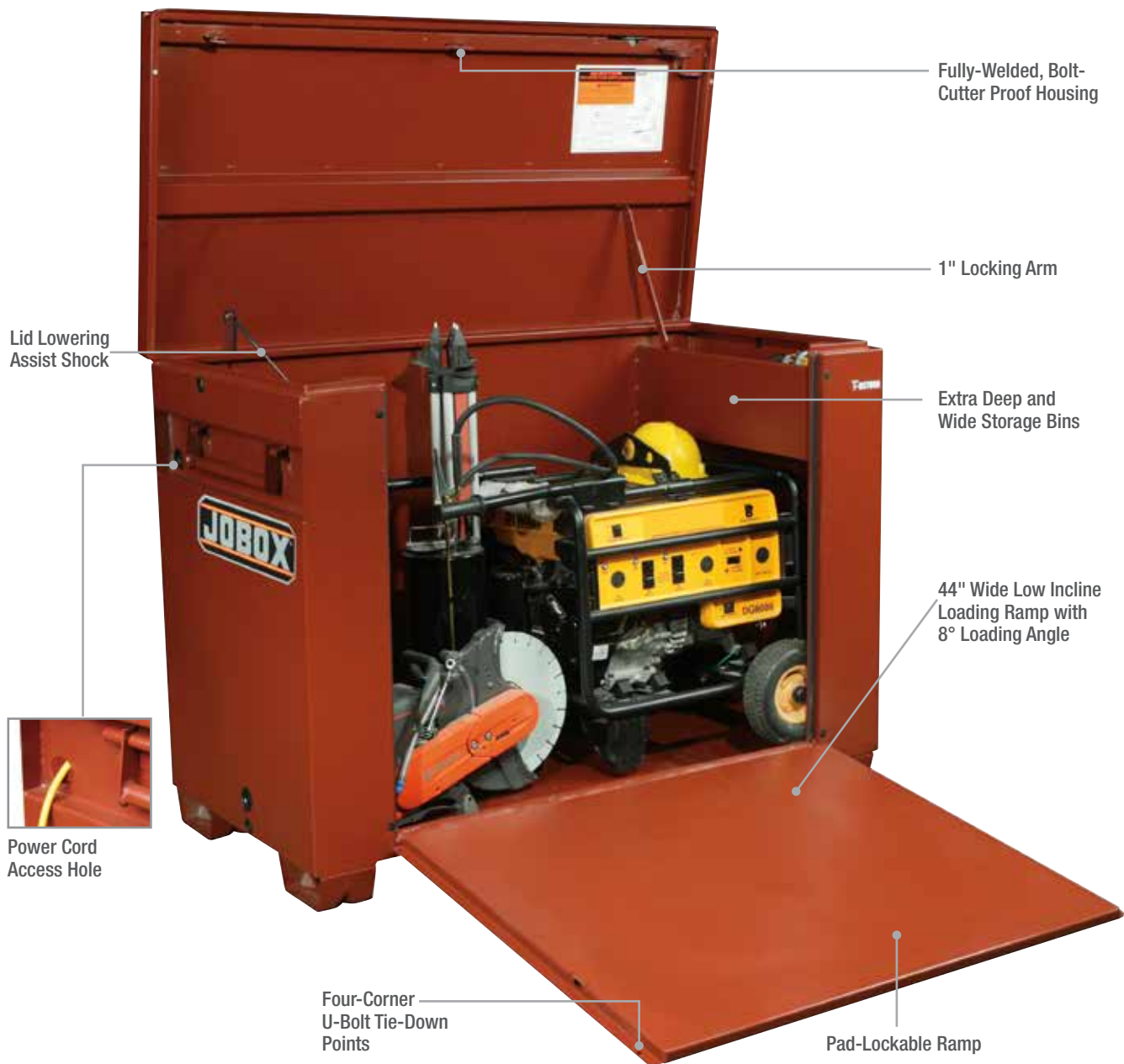



An industry first, the JOBOX High Capacity Drop-Front Chest combines access with legendary JOBOX toughness and security. The reinforced front drops down to an amazingly low 8 degree loading angle, allowing users to easily roll larger, heavier objects such as generators, spools, and large tools into the chest.

-  EZ-Loader® Skid Bolsters
-  Staked & Welded Hinge
-  Heavily Reinforced Lid
-  Holes to Install Optional Casters
-  Site-Vault™ Security System
-  Grip-Rite™ Lifting Channel
-  Recessed Handles
-  Textured Powder Paint Finish
-  Gas-Spring Guards



Catalog No.	Length	Width	Height	Shipping Cu. Ft.	Approx. Shipping Wt.
1-657990	60 in	31 in	45 in	50.8 ft³	320 lb

HEAVY-DUTY LIFTING CHEST

-  EZ-Loader® Skid Bolsters
-  Site-Vault™ Security System
-  Staked & Welded Hinge
-  Grip-Rite™ Lifting Channel
-  Heavily Reinforced Lid
-  Recessed Handles
-  Holes to Install Optional Casters
-  Textured Powder Paint Finish
-  Gas-Spring Guards

Designed for lifting between floors, weather resistance, and durability, the JOBOX Heavy-Duty Chest now has four recessed lifting points for increased portability and security. The industry leading four-point rigging system is safety rated to provide a 2500 lbs. gross weight load capacity. Plus, with storage bins on each side wall, a third skid bolster and additional bottom reinforcement, JOBOX has created the toughest and most user-friendly chest yet.

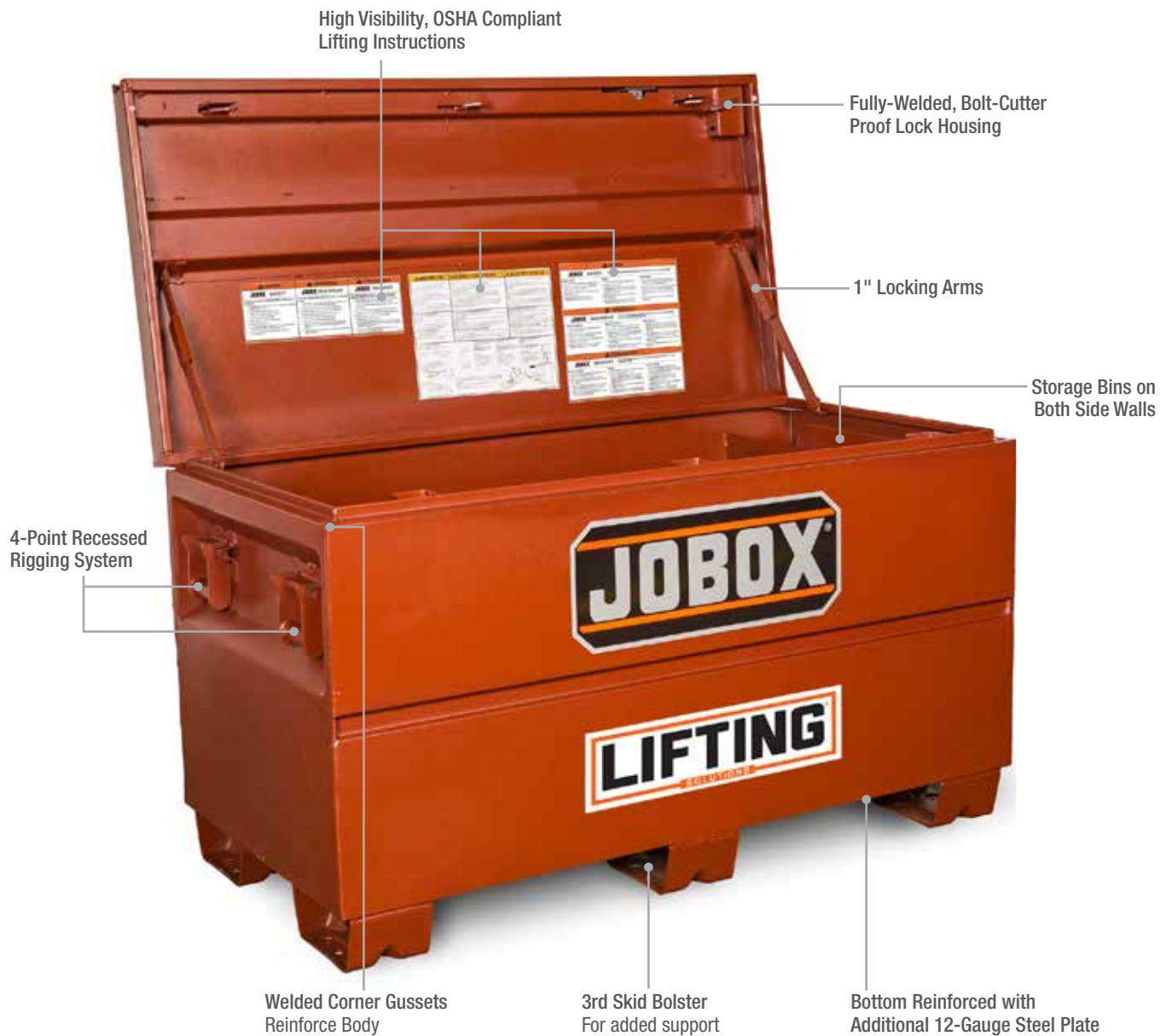









**Sling Recommendation: 88000 – 3/8" x 6', 4 Leg Sling with Latched Sling Hooks*

Catalog No.	Length	Width	Height	Shipping Cu. Ft.	Approx. Shipping Wt.
1-659990	48 in	24 in	27.75 in	22.3 ft³	199 lb

LIFTING PIANO BOX

The perfect combination of storage space and organization now includes the industry leading JOBBOX four-point rigging system. Safety rated to allow a 2500 lbs. gross weight load capacity, the four recessed lifting points provide increased portability and security to the world renowned JOBBOX Piano Box. With all the features of the base models, plus a third skid bolster and additional bottom reinforcement, the most durable Piano Box in the world ensures your valuables remain safe and secure.

-  EZ-Loader® Skid Bolsters
-  Site-Vault™ Security System
-  Staked & Welded Hinge
-  Grip-Rite™ Lifting Channel
-  Heavily Reinforced Lid
-  Recessed Handles
-  Holes to Install Optional Casters
-  Textured Powder Paint Finish
-  Gas-Spring Guards











***Sling Recommendation: 88000 – 3/8" x 6', 4 Leg Sling with Latched Sling Hooks**

Catalog No.	Length	Width	Height	Shipping Cu. Ft.	Approx. Shipping Wt.
1-686990	60 in	31 in	50 in	60 ft³	394 lb

PIANO BOXES

The perfect combination of storage space, organization, and security, the world renowned JOBOX Piano Box is a job site must-have. Two storage bins on both side walls and the JOBOX Lift-n-Stow Shelf give you room to store any item, while the Site-Vault™ lock system ensures that your valuables remain safe and secure.









-  EZ-Loader® Skid Bolsters
-  Site-Vault™ Security System
-  Staked & Welded Hinge
-  Grip-Rite™ Lifting Channel
-  Heavily Reinforced Lid
-  Recessed Handles
-  Holes to Install Optional Casters
-  Textured Powder Paint Finish
-  Gas-Spring Guards



Catalog No.	Length	Width	Height	Shipping Cu. Ft.	Approx. Shipping Wt.
1-681990	48 in	31 in	50 in	49 ft³	286 lb
1-682990	60 in	31 in	50 in	60 ft³	326 lb
1-688990	60 in	31 in	38 in	45 ft³	283 lb
1-689990	74 in	31 in	50 in	73 ft³	423 lb

HIGH-CAPACITY PIANO BOX

Standing at nearly 5 feet tall, this behemoth provides three center and side storage shelves, and punched holes for hanging safety harnesses and tethered tools. The High-Capacity Piano Box offers 75% more storage capacity than our popular Piano Box.









-  EZ-Loader® Skid Bolsters
-  Staked & Welded Hinge
-  Heavily Reinforced Lid
-  Holes to Install Optional Casters
-  Site-Vault™ Security System
-  Grip-Rite™ Lifting Channel
-  Recessed Handles
-  Textured Powder Paint Finish
-  Gas-Spring Guards



Catalog No.	Length	Width	Height	Shipping Cu. Ft.	Approx. Shipping Wt.
1-685990	74 in	34.63 in	63 in	92.2 ft³	469 lb

DROP-FRONT PIANO BOXES

Got heavy equipment? No problem. The Drop Front Piano Box offers an industry first bolster reinforced ramp, making it easy to roll or put heavy items in the bottom. Access doesn't have to mean compromise in security, JOBOX's drop down ramp is secured with two heavy-duty, padlock-able sliding gate bolts.









-  EZ-Loader® Skid Bolsters
-  Site-Vault™ Security System
-  Staked & Welded Hinge
-  Grip-Rite™ Lifting Channel
-  Heavily Reinforced Lid
-  Recessed Handles
-  Holes to Install Optional Casters
-  Textured Powder Paint Finish
-  Gas-Spring Guards



Catalog No.	Length	Width	Height	Shipping Cu. Ft.	Approx. Shipping Wt.
1-683990	60 in	30 in	50 in	60 ft³	354 lb
1-684990	74 in	30 in	50 in	73 ft³	453 lb

FIELD OFFICE









Your office away from the office, only much more organized with loads of storage and world class durability. The office center provides an extra-large, lockable desktop with high visibility white interior and hanging pegs. Plenty of storage space including an easy access rear storage locker for longer tools and equipment.

-  EZ-Loader® Skid Bolsters
-  Staked & Welded Hinge
-  Heavily Reinforced Lid
-  Holes to Install Optional Casters
-  Site-Vault™ Security System
-  Grip-Rite™ Lifting Channel
-  Recessed Handles
-  Textured Powder Paint Finish
-  Gas-Spring Guards



Catalog No.	Length	Width	Height	Storage Cap. Upper	Storage Cap. Lower	Shipping Cu. Ft.	Approx. Shipping Wt.
1-674990	63 in	42 in	80 in	60.6 ft³	9.4 ft³	123.5 ft³	660 lb

HEAVY EQUIPMENT BOX

-  EZ-Loader® Skid Bolsters
-  Site-Vault™ Security System
-  Staked & Welded Hinge
-  Grip-Rite™ Lifting Channel
-  Heavily Reinforced Lid
-  Recessed Handles
-  Holes to Install Optional Casters
-  Textured Powder Paint Finish
-  Gas-Spring Guards









Designed for extreme applications, the JOBOX Heavy Equipment Box provides durability for any job site. This innovative design combines JOBOX toughness with total access, by adding our industry leading drop down ramp. The user-friendly bolster reinforced ramp makes rolling larger, heavier tools and equipment into the box easy and safe. Storage bins on the side walls and additional welded storage on the back wall make organization effortless. The addition of reinforcement to the bolsters and around the perimeter makes the Heavy Equipment Box the strongest storage solution available.



Catalog No.	Length	Width	Height	Shipping Cu. Ft.	Approx. Shipping Wt.
1-687990	70 in	31 in	38 in	65 ft³	407 lb

DRAWER CABINET

JOBOX Drawer Cabinets offer the same security and accessibility features as our Heavy-Duty Cabinets, but with fully extendable High-Load Capacity Drawers for added storage options.









-  EZ-Loader® Skid Bolsters
-  Staked & Welded Hinge
-  Heavily Reinforced Lid
-  Holes to Install Optional Casters
-  Site-Vault™ Security System
-  Grip-Rite™ Lifting Channel
-  Recessed Handles
-  Textured Powder Paint Finish
-  Gas-Spring Guards



Catalog No.	Height	Width	Depth	Door Height	Door Width	Shipping Cu. Ft.	Approx. Shipping Wt.
1-679990	60-3/4 in	60-1/8 in	30-1/4 in	53-1/4 in	25-3/4 in	62.5 ft³	610 lb

ROLLING CLAMSHELL CABINET

The JOBBOX Clam Shell Cabinet offers an easy to move storage solution with optimal organization and security options. 10-gauge, specially designed latching hasp prevents pry bars and cutting tools from accessing the cabinet. Moveable top and bottom shelves, open storage closet, and lockable storage areas are all included in our versatile Clam Shell cabinet.









-  EZ-Loader® Skid Bolsters
-  Site-Vault™ Security System
-  Staked & Welded Hinge
-  Grip-Rite™ Lifting Channel
-  Heavily Reinforced Lid
-  Recessed Handles
-  Holes to Install Optional Casters
-  Textured Powder Paint Finish
-  Gas-Spring Guards



Catalog No.	Length	Width	Height	Shipping Cu. Ft.	Approx. Shipping Wt.
692990	62.25 in	30 in	63.5 in	72 ft³	472 lb

HEAVY-DUTY CABINETS

Organization how you want it. With four models to choose from with varying storage capacity and door options, JOBOX Cabinets give you the power to make organizing your job site, plant floor, or maintenance bay a cinch. With the innovative foot operated latch and anti-tip bolsters, you also get first class accessibility and safety features.

-  EZ-Loader® Skid Bolster
-  Site-Vault™ Security System
-  Staked & Welded Hinge
-  Grip-Rite™ Lifting Channel
-  Heavily Reinforced Lid
-  Recessed Handles
-  Holes to Install Optional Casters
-  Textured Powder Paint Finish
-  Gas-Spring Guards



Recessed Handles

Welded Corner Gussets

Fully-Welded Padlock Housing

Three 5/8" Steel Locking Pins Per Door

Nearly 17 Linear Ft. of Door Shelf Storage



Access Holes for Electrical Cables

Hand or Foot Operated Door Latch Release System

High-Strength Heavy-Duty Shelves









Three Heavy Duty Lock Hooks Per Door

Catalog No.	Description	Length	Width	Height	Shipping Cu. Ft.	Approx. Shipping Wt.
1-694990 (shown)	Two Doors	60.75 in	24.25 in	60.25 in	53.2 ft³	379 lb
1-695990	Four Doors, Both Sides	60.13 in	32.25 in	60.75 in	66.5 ft³	523 lb
1-697990	Two Doors, Open Side	60.13 in	24.25 in	60.75 in	53.2 ft³	366 lb
1-698990	Two Doors	60.13 in	30.25 in	60.75 in	62.5 ft³	436 lb

EXTRA-HEAVY DUTY BIN CABINET

Touting a massive 49 cu. ft. storage capacity, the Extra-Heavy Duty Bin Cabinet has no equal in modifiable organization solutions. Dividers can be moved in as little as 2" increments or removed to create various sized bins. Perfect for organization of tools, personal equipment, safety materials and more.

*612990 - Optional Handles available for separate purchase









-  EZ-Loader® Skid Bolster
-  Site-Vault™ Security System
-  Staked & Welded Hinge
-  Grip-Rite™ Lifting Channel
-  Heavily Reinforced Lid
-  Recessed Handles
-  Holes to Install Optional Casters
-  Textured Powder Paint Finish
-  Gas-Spring Guards



Catalog No.	Length	Width	Height	Shipping Cu. Ft.	Approx. Shipping Wt.
1-693990	72 in	24 in	61 in	59.1 ft³	522 lb

ROLLING WORK BENCHES

For the ultimate in portability and accessibility, the Rolling Work Bench provides superior strength casters, shelving and drawers to meet the most arduous working environment demands. Users can arrange the Rolling Work Bench into four unique configurations to meet their particular storage needs.

-  EZ-Loader® Skid Bolster
-  Staked & Welded Hinge
-  Heavily Reinforced Lid
-  Holes to Install Optional Casters
-  Site-Vault™ Security System
-  Grip-Rite™ Lifting Channel
-  Recessed Handles
-  Textured Powder Paint Finish
-  Gas-Spring Guards





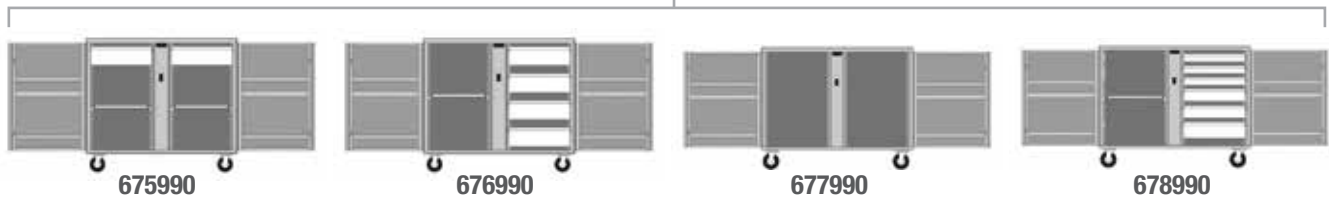





Fully Adjustable Interiors for Maximum Storage Flexibility



Catalog No.	Description	Length	Width	Height	Shipping Cu. Ft.	Approx. Shipping Wt.
675990	2 Drawers, 2 Shelves, 4" Casters	43.88 in	26.88 in	38.5 in	24.8 ft³	267 lb
675996	2 Drawers, 2 Shelves, 6" Casters	43.88 in	26.88 in	40.5 in	24.8 ft³	280 lb
676990	4 Drawers, 1 Shelf, 4" Casters	43.88 in	26.88 in	38.5 in	224.8 ft³	294 lb
676996	4 Drawers, 1 Shelf, 6" Casters	43.88 in	26.88 in	40.5 in	24.8 ft³	307 lb
677990	Body with 6" Casters, Add Drawers & Shelves	43.88 in	26.88 in	40.63 in	28.1 ft³	264 lb
678990	6 Drawers, 1 Shelf, 6" Casters	43.88 in	26.88 in	40.63 in	28.1 ft³	390 lb

WELDER'S BOX & SMALL CHESTS

Smartly designed to get the job done. With features like cutouts for tools connected to supply hoses on our Welder's Boxes, and bolt-cutter-proof lock housings on our Small Chests, JOBOX offers essential storage staples for workers on the go.

-  EZ-Loader® Skid Bolster
-  Staked & Welded Hinge
-  Heavily Reinforced Lid
-  Holes to Install Optional Casters
-  Gas-Spring Guards
-  Site-Vault™ Security System
-  Grip-Rite™ Lifting Channel
-  Recessed Handles
-  Textured Powder Paint Finish



Catalog No.	Description	Length	Width	Height	Shipping Cu. Ft.	Approx. Shipping Wt.
650990 (shown, left)	Welder's Box	30 in	16 in	12 in	4.6 ft³	33 lb
651990 (shown, right)	Embedded Lock	31 in	18 in	15.5 in	5.7 ft³	70 lb
659990	Hasp Lock, No Cut Out	30 in	16 in	12 in	4.6 ft³	33 lb

ON-SITE STORAGE ACCESSORIES

REPLACEMENT DRAWERS, SHELF AND HANDLE FOR ROLLING WORK BENCHES



■ 18 Gauge Steel Drawers have heavy-duty ball bearing glides

Catalog No.	Description	Used On
604990	Shelf	Models 675 & 676
608990	Shelf	Models 677 & 678
605990	2-1/2" Deep Drawer	Models 675 & 676
609990	2-1/2" Deep Drawer	Models 677 & 678
606990	4-1/2" Deep Drawer	Models 675 & 676
610990	4-1/2" Deep Drawer	Models 677 & 678
607990	5-1/2" Deep Drawer	Models 675 & 676
611990	5-1/2" Deep Drawer	Models 677 & 678
616990	10" Deep Drawer	Models 675 & 676
617990	10" Deep Drawer	Models 677 & 678
612990	Optional 2nd Push Handle	Models 675 & 676

REMOVABLE TRAYS



- Built-In Handles for storing small parts or tools
- Hemmed Edges add strength and eliminate sharp edges

Catalog No.	Length	Width	Height	Used On
624990D	16-3/16 in	8 in	4 in	651990
626990	22-3/16 in	8 in	4 in	1-654990, 1-655990, 1-658990, 1-659990
627990	28-3/16 in	8 in	4 in	1-656990, 1-659990
628990	18-3/16 in	8 in	4 in	1-652990, 1-653990

REPLACEMENT FASTENER KITS

Catalog No.	UPC No.	Used On
10318-410	043419927223	635990, 636990, 637990, 638990, 639990, 648990
10318-411	043419938243	675990, 676990, 677990, 678990
10318-412	043419938250	1-669990, 1-674990, 1-679990, 1-693990, 1-694990, 1-695990, 1-697990, 1-698990
10318-415		692990
10318-416	043419932463	651990
10318-705	043419938311	1-652990, 1-653990, 1-654990, 1-655990, 1-656990, 1-657990, 1-658990, 1-659990, 1-680990, 1-681990, 1-682990, 1-683990, 1-684990, 1-685990, 1-686990, 1-687990, 1-688990,

TOUCH UP PAINT



■ Available in 12 oz Cans

Catalog No.	UPC No.	Used On
82936	043419942240	All JOBBOX Models

OPTIONAL CASTERS



- Easily maneuver heavy loads
- Available in Heavy-Duty and Non-Marking
- Set of 4 casters come with 2 fixed and 2 swivel casters
- Wheels never puncture or go flat
- 3" x 3" hole patterns
- Corresponds with all JOBBOX Models

Catalog No.	Size	Style	Load Rating	Approx. Shipping Wt.
1-320991	4 in	HD	2800 lb	14 lb
1-320992	5 in	HD	3200 lb	15 lb
1-320993	6 in	HD	3600 lb	18 lb
1-320994	6 in	NM	3600 lb	27 lb

SAFETY STORAGE

1ST UL CERTIFIED ON-SITE
FLAMMABLE STORAGE



SELF-CLOSING
FLAMMABLE CABINET



PAINT CABINET



TYPE I & II CANISTERS



SAFETY CABINET

SAFETY STORAGE STORAGE CHECKLIST

FLAMMABLE LIQUIDS

Frequent inspection is an extremely important aspect of safe flammable liquid handling and storage. Establish a regularly scheduled visual inspection of every safety cabinet in your facility to verify compliance with all applicable regulations. Do not become complacent. A little preventative work can go far in preventing a fire hazard.

Periodically verify the following items for each cabinet in your facility and correct immediately if not in compliance:



Ensure the immediate area where the cabinet is located is clear of debris and away from running machinery or any activity involving heat. The floor or decking beneath the cabinet should be solid and stable.



For self-closing cabinets, verify that fusible link assemblies for all doors are properly installed and that only OEM (from the original manufacturer) fusible links are used.



Ensure Material Safety Data Sheet (MSDS), whether paper or electronic, for the liquid being stored is close by and readily accessible.



Ensure contents of cabinet are organized so all contents are visible and identifiable without moving items out of the way. Verify that all containers in the cabinet are properly closed and sealed.



Ensure shelves are clean and sit fully in the side wall brackets.



Ensure cabinet is properly grounded to facility grounding grid or earth source if applicable. Grounding is mandatory if liquids are ever transferred from inside the cabinet.



Using a standard bubble level, verify that the cabinet is level.



Verify that there is no debris accumulation underneath the cabinet.



Verify that the cabinet sump is clean and empty. If liquid or debris is found, ensure it is removed immediately using approved procedures and properly disposed of.



Verify that cabinet is properly vented if required. If cabinet venting is not required, ensure cabinet is in a well ventilated area and that venting caps are tightly closed.



Verify that cabinet is locked and that only properly trained and authorized personnel have access.

Ensure cabinet is the appropriate color for the liquid being stored.



**PAINTS
INKS
COMBUSTIBLES**

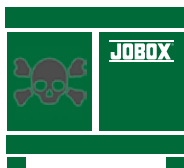

**PESTICIDES
INSECTICIDES**



FLAMMABLES

SAFETY COMPLIANCE

JOBBOX cabinets and cans comply with all applicable specifications set forth by the Occupational Safety and Health Administration (OSHA) and the National Fire Protection Association (NFPA). JOBBOX self-closing cabinets also comply with the International Code Consortium/International Fire Code (IFC). Compliance to these specifications has been independently tested and listed by Underwriters Laboratories (UL) the internationally recognized third-party testing organization.

SAFETY CANS



- NFPA Compliant Container for Storage of Kerosine (Blue can) or Diesel (Yellow can)
- NFPA Compliant Container for Storage of Gasoline (Red can)
- Specified by the Safety Professional ~ Required by OSHA in the Workplace
- Meets ASTM F839/F926

SAFETY / SELF-CLOSING SAFETY CABINETS



- Specified by the Safety Professional ~ Required by OSHA in the Workplace
- Meets requirements of OSHA 29 CFR 1910.106
- IFC Compliant
- Meets requirements of NFPA 30

JOBBOX SAFETY STORAGE))))

The innovative features of JOBBOX safety cabinets and cans make flammable liquids storage compliance easier.



EZ-LEVEL™

SKID BOLSTERS



- Leveling Screw Access Hole provides quick and easy access
- Unique Anti-tip Design extends the base foot print beyond the width of the cabinet for maximum stability and tipping resistance
- 7-Gauge Steel Construction
- Fork Lift and Pallet Jack Ready for increased mobility and easy cleaning underneath the cabinet.



SELF-CLOSING SYSTEM



- Self-Latching 3-Point Door Lock System
- Heavy-Duty Enclosed Staggering Mechanism ensures doors close in proper order
- Stainless Steel Slam Latches
- Heavy-Duty Chain holds doors open during work
- Fusible Chain Link shears at 165°F to close doors



BRIGHT WHITE INTERIOR



- Maximum Visibility in low light conditions, allowing users to quickly and safely identify cabinet contents



HI-VIZ SAFETY LABELS



- Safety and Warning Labels provide permanent reminder and reference for users to follow proper safety and usage practices
- Sharp Contrasting Colors for high visibility



EXTRA-WIDE DOORS



- 2.5" Thick Doors provide greater insulation gap between metal panels for added durability and safety



STAKED HINGES



- 14-Gauge Steel
- 3/8" Staked, Continuous Hinge with 1/4" steel pin and extra-large 1" knuckles
- Pin cannot be driven out for added security



SPILL GUIDE SHELVING



- Safety Cabinet Shelves gently guide spills
- Liquids are guided toward the 2" deep leak-proof sump for easy clean-up



TEXTURED POWDER PAINT FINISH

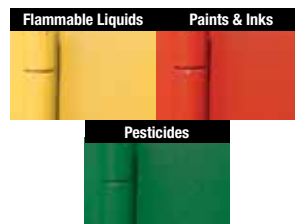

- High-Quality Powder Paint improves durability over liquid paint
- Available in the Industry Standard Color options shown

10x

corrosion resistance

5x

abrasion resistance

2x

chip resistance

2x

scratch resistance

www.safety.jobox.com

HEAVY-DUTY SAFETY CABINETS

Keep flammable liquids organized, secure, and protected from fire with UL listed JOBOX Safety Cabinets. With exclusive features like EZ Level™ bolsters, permanent safety labels, and white interiors, these cabinets offer improved safety with the security and durability JOBOX storage products are known for.

1st
UL Certified
On-Site
Flammable
Storage



EZ-Level®
Skid Bolsters



Extra Wide
Doors



Spill Guide
Shelving



Staked Hinges



Bright White
Interior



Textured Powder
Paint Finish



Hi-Viz
Safety Labels



Self-Closing
System

YELLOW

Textured Powder Paint Finish
Yellow: Flammable Liquid Storage

Available in 12, 30, 45, 60
and 90 Gallon sizes

- Industry First Hi-Viz Grounding, Venting, and Secondary Safety Labels
- EZ-Level™ Skid Bolsters offer Leveling-Screw Access Hole and unique anti-tip shape
- Bright White Interior for better visibility
- Spill Guide Shelving for improved spill containment and clean-up
- Extra-Wide 2.5" Doors



Adjustable Shelving

Padlock-able
Paddle Handle

3-Point Door
Lock System

High/Low Vent
Connections

18-Gauge Double
Wall Construction



5
YR.
LIMITED
WARRANTY

Catalog No.	Capacity	Exterior Dimensions H x W x D	Interior Dimensions H x W x D	No. of Doors	No. of Spill Guide Shelves	Compliance / Listings	Approx. Shipping Wt.
1-850990	12 gal (US), 45 l	35.50 x 30.13 x 19.69	32.31 x 26.63 x 16.17	1	1	UL, NFPA, OSHA,	175 lb
1-853990	30 gal (US), 113.5 l	49 x 46.88 x 19.63	39.94 x 42.38 x 14.75	2	1	UL, NFPA, OSHA,	276 lb
1-856990	45 gal (US), 170 l	67.25 x 46.88 x 19.63	57.91 x 45.47 x 14.78	2	2	UL, NFPA, OSHA,	363 lb
1-858990	60 gal (US), 227 l	67.25 x 46.15 x 26.28	57.94 x 42.44 x 21.81	2	2	UL, NFPA, OSHA,	421 lb
1-859990	90 gal (US), 340.6 l	67.28 x 46.90 x 31.59	57.94 x 42.44 x 26.81	2	2	UL, NFPA, OSHA,	465 lb

HEAVY-DUTY SAFETY CABINETS

JOBBOX Red Safety Cabinets offer the same storage and security features as the yellow cabinets, but are industry standard red for storage of paints, inks, and other combustibles.

RED

Textured Powder Paint Finish
Red: Paints, Inks, and other Combustible Storage.

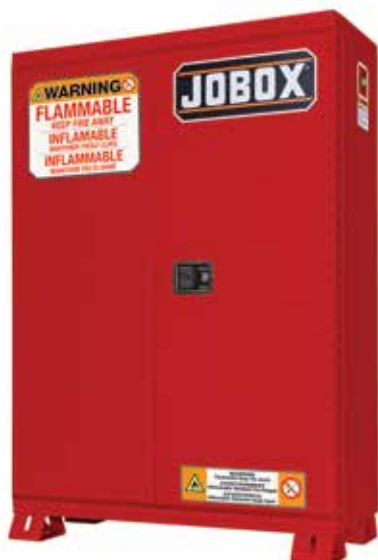

Catalog No.	Capacity	Exterior Dimensions H x W x D	Interior Dimensions H x W x D	No. of Doors	No. of Spill Guide Shelves	Compliance / Listings	Approx. Shipping Wt.
1-850610	12 gal (US), 45 l	35.50 x 30.13 x 19.69	32.31 x 26.63 x 16.17	1	1	UL, NFPA, OSHA,	175 lb
1-853610	30 gal (US), 113.5 l	49 x 46.88 x 19.63	39.94 x 42.38 x 14.75	2	1	UL, NFPA, OSHA,	276 lb
1-856610	45 gal (US), 170 l	67.25 x 46.88 x 19.63	57.91 x 45.47 x 14.78	2	2	UL, NFPA, OSHA,	363 lb
1-858610	60 gal (US), 227 l	67.25 x 46.15 x 26.28	57.94 x 42.44 x 21.81	2	2	UL, NFPA, OSHA,	421 lb
1-859610	90 gal (US), 340.6 l	67.28 x 46.90 x 31.59	57.94 x 42.44 x 26.81	2	2	UL, NFPA, OSHA,	465 lb

HEAVY-DUTY SAFETY CABINETS

JOBBOX Green Safety Cabinets offer the same storage and security features as the yellow cabinets, but are industry standard green for storage of outdoor chemicals.

GREEN

Textured Powder Paint Finish
Green: Outdoor Chemical Storage.











Catalog No.	Capacity	Exterior Dimensions H x W x D	Interior Dimensions H x W x D	No. of Doors	No. of Spill Guide Shelves	Compliance / Listings	Approx. Shipping Wt.
1-850670	12 gal (US), 45 l	35.50 x 30.13 x 19.69	32.31 x 26.63 x 16.17	1	1	UL, NFPA, OSHA,	175 lb
1-853670	30 gal (US), 113.5 l	49 x 46.88 x 19.63	39.94 x 42.38 x 14.75	2	1	UL, NFPA, OSHA,	276 lb
1-856670	45 gal (US), 170 l	67.25 x 46.88 x 19.63	57.91 x 45.47 x 14.78	2	2	UL, NFPA, OSHA,	363 lb
1-858670	60 gal (US), 227 l	67.25 x 46.15 x 26.28	57.94 x 42.44 x 21.81	2	2	UL, NFPA, OSHA,	421 lb
1-859670	90 gal (US), 340.6 l	67.28 x 46.90 x 31.59	57.94 x 42.44 x 26.81	2	2	UL, NFPA, OSHA,	465 lb

SELF-CLOSING SAFETY CABINETS

With JOBOX Self-Closing Cabinets, users can work freely with peace of mind knowing that their flammable liquids will be secure. Extra-robust fusible link system will operate at 165°F to close the doors, and a heavy-duty, galvanized staggering mechanism ensures the doors close securely in the event of a fire. Fully enclosed, the JOBOX self-closing system ensures safe operation while offering maximum storage space inside the cabinet.

**1st
UL Certified
On-Site
Flammable
Storage**

-  EZ-Level® Skid Bolsters
-  Spill Guide Shelving
-  Bright White Interior
-  Hi-Viz Safety Labels
-  Extra Wide Doors
-  Staked Hinges
-  Textured Powder Paint Finish
-  Self-Closing Door Lock System

YELLOW

Textured Powder Paint Finish
Yellow: Flammable Liquid Storage

- Self-Closing 3-Point Door Lock System
- Heavy-Duty Enclosed Staggering Mechanism
- Heavy-Duty Chain holds doors open during work, Fusible Chain Link shears at 165°F to close doors
- EZ-Level™ Skid Bolsters offer Leveling-Screw Access Hole and unique anti-tip shape
- Bright White Interior for better visibility



Adjustable Shelving

Padlock-able Paddle Handle

3-Point Door Lock System

High/Low Vent Connections

18-Gauge Double Wall Construction



5
YR.
LIMITED
WARRANTY

Catalog No.	Capacity	Exterior Dimensions H x W x D	Interior Dimensions H x W x D	No. of Doors	No. of Spill Guide Shelves	Compliance / Listings	Approx. Shipping Wt.
1-854990	30 gal (US), 113.5 l	49 x 46.09 x 19.63	39.94 x 42.38 x 14.75	2	1	UL, NFPA, OSHA, IFC	285 lb
1-857990	45 gal (US), 170 l	67.25 x 46.88 x 21.25	57.91 x 45.47 x 14.78	2	2	UL, NFPA, OSHA, IFC	372 lb

SELF-CLOSING SAFETY CABINETS



JOBBOX Red self-closing safety cabinets offer the same storage and security features as the yellow cabinets, but are industry standard red for storage of paints, inks, and other combustibles.

RED

Textured Powder Paint Finish
Red: Paints, Inks, and other Combustible Storage.

Catalog No.	Capacity	Exterior Dimensions H x W x D	Interior Dimensions H x W x D	No. of Doors	No. of Spill Guide Shelves	Compliance / Listings	Approx. Shipping Wt.
1-854610	30 gal (US), 113.5 l	49 x 46.09 x 19.63	39.94 x 42.38 x 14.75	2	1	UL, NFPA, OSHA, IFC	285 lb
1-857610	45 gal (US), 170 l	67.25 x 46.88 x 21.25	57.91 x 45.47 x 14.78	2	2	UL, NFPA, OSHA, IFC	372 lb

SELF-CLOSING SAFETY CABINETS

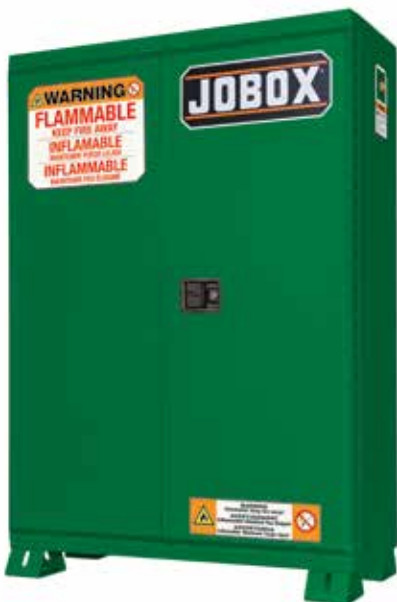

JOBBOX Green safety cabinets offer the same storage and security features as the yellow cabinets, but are industry standard green for storage of outdoor chemicals.

GREEN

Textured Powder Paint Finish
Green: Outdoor Chemical Storage.

Catalog No.	Capacity	Exterior Dimensions H x W x D	Interior Dimensions H x W x D	No. of Doors	No. of Spill Guide Shelves	Compliance / Listings	Approx. Shipping Wt.
1-854670	30 gal (US), 113.5 l	49 x 46.09 x 19.63	39.94 x 42.38 x 14.75	2	1	UL, NFPA, OSHA, IFC	285 lb
1-857670	45 gal (US), 170 l	67.25 x 46.88 x 21.25	57.91 x 45.47 x 14.78	2	2	UL, NFPA, OSHA, IFC	372 lb

TYPE I FLAMMABLE LIQUIDS CANISTERS

JOBBOX Type I Cans are made of resilient terne plate steel for the ultimate in corrosion resistance. They have one opening and recommended for storage, but can be used with a funnel for pouring into other containers. Stringently UL and ULC tested and listed.



800990 - Funnel accessory available for separate purchase

5 YR.
LIMITED WARRANTY



Red - Gasoline/Flammable Liquids				
Catalog No.	Capacity	Diameter (in) x Hose L	Compliance / Listings	Approximate Ship Weight
812990	2 gal (US), 7.5 l	9 x 6	UL/ULC/OSHA/NFPA	6 lb
812990F*	2 gal (US), 7.5 l	9 x 6	UL/ULC/OSHA/NFPA	6 lb
815990	5 gal (US), 19 l	11.5 x 9	UL/ULC/OSHA/NFPA	9 lb
815990F*	5 gal (US), 19 l	11.5 x 9	UL/ULC/OSHA/NFPA	9 lb
Yellow - Diesel				
812990Y	2 gal (US), 7.5 l	9 x 6	UL/ULC/OSHA/NFPA	6 lb
812990YF*	2 gal (US), 7.5 l	9 x 6	UL/ULC/OSHA/NFPA	6 lb
815990Y	5 gal (US), 19 l	11.5 x 9	UL/ULC/OSHA/NFPA	9 lb
815990YF*	5 gal (US), 19 l	11.5 x 9	UL/ULC/OSHA/NFPA	9 lb

* Funnel Included

TYPE II FLAMMABLE LIQUIDS CANISTERS

Designed for pouring flammable liquids. Type II Cans offer two openings, one for fill and one for pour. Brass tipped pouring hose prevents sparking, and special implosion resistance system ensures a safe pour every time. Stringently UL and ULC Tested and Listed.



Replacement nozzles available:
830990 - 3/4" x 6"
835990 - 3/4" x 9"



5 YR.
LIMITED WARRANTY

Red - Gasoline/Flammable Liquids				
Catalog No.	Capacity	Diameter (in) x Hose L	Compliance / Listings	Approximate Ship Weight
822990	2 gal (US), 7.5 l	9 x 6	UL/ULC/OSHA/NFPA	8.5 lb
825990	5 gal (US), 19 l	11.5 x 9	UL/ULC/OSHA/NFPA	12 lb
Yellow - Diesel				
822990Y	2 gal (US), 7.5 l	9 x 6	UL/ULC/OSHA/NFPA	8.5 lb
825990Y	5 gal (US), 19 l	11.5 x 9	UL/ULC/OSHA/NFPA	12 lb

TRUCK STORAGE



CROSSOVERS, INNERSIDES & LADDER RACKS



TOPSIDES



TRANSFER TANKS



UNDERBEDS



DRAWER STORAGE

JOBBOX PROFESSIONAL TRUCK STORAGE))))

GEAR-LOCK II™ LOCKING SYSTEM



- Ratcheting action pulls lid tight to resist over **2,000 lbs.** of prying and pulling force
- Provides the highest level of security and moisture resistance available
- Self-adjusting dual rotary lock system is covered by a heavy-duty guard

GUARDED HEAVY-DUTY GAS SPRINGS



- Heavy-Duty Gas Springs provide 70 lbs. of pressure for easy lifting of lid
- Gas spring guards ensure long-term durability

SELF-ALIGNING LATCH HOOPS



- Hoops cannot be bent or pried out of lock system
- Hoops pivot from side-to-side to engage the Gear-Lock® System
- Guarantees a tight seal first time—every time

BOLSTER-REINFORCED RSL™ RIGID STRUCTURE LID



- High-strength RSL® Laminated 3-Layer Rigid Structural Lid provides superior strength, security, and durability
- RSL® Lid is reinforced with two full-length bolsters

PUSH BUTTON LOCK



- End-mounted push button locks provide easy access
- Box can be locked and unlocked from either side

GUARDED THREE-POINT LOCKING SYSTEM



- Lock system engages body in three points to create a tight seal and excellent pry-resistance
- Steel lock cover protects lock system and reinforces the high-strength door

HIGH STRENGTH, QUICK- RELEASE DOOR CABLES



- High-strength, coated, galvanized steel cables support 300 lb. load
- Quick-release feature allows door to drop all the way down for easier access

BULB-SHAPED WEATHER STRIPPING



- Surrounds door or lid to seal out moisture and dust, keeping contents and box protected

JOBBOX TRUCK STORAGE >>>>>

GEAR-LOCK™
 LOCKING SYSTEM

- Ratcheting action pulls lid tight to resist over 1,000 lb. of prying and pulling force
- Provides a high level of security and moisture resistance
- Self-adjusting dual rotary lock system is covered by a heavy-duty guard

RSL™ RIGID STRUCTURAL LID

- High-strength RSL® Laminated 3-Layer Rigid Structural Lid provides superior strength, security, and durability

GUARDED GAS SPRINGS

- Provide easy lifting of lid
- Gas spring guards ensure long-term durability

SELF-ALIGNING LATCH PINS

- Pins pivot from side-to-side to engage the Gear-Lock® System
- No adjustment is required

PUSH BUTTON LOCK

- End-mounted push button locks provide easy access
- Box can be locked and unlocked from either side

QUICK-RELEASE DOOR CABLES



- Quick-release feature allows door to drop all the way down for easier access







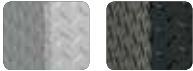





STAINLESS STEEL ROTATING T-HANDLE



- T-Handles have reinforced cam locks and are sealed to prevent moisture from getting inside

ALUMINUM SINGLE LID CROSSOVERS

JOBBOX Professional is the ultimate in truck storage security and capacity. Single Lid provides the best access to the entire inside of the box, and more easily accommodates large and long items. The Rigid Structure Lid (RSL) has two layers of aluminum joined with rigid foam, plus additional full length bolsters for superior strength and rigidity. Plus, users now have increased visibility with the new lower profile design.

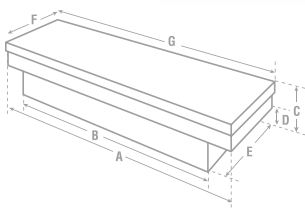

-  GearLock™ Locking System
-  Dual Rotary GearLock II™ Locking System
-  Self Aligning Latch Pins
-  Self Aligning Latch Hoops
-  Gas Spring Guards
-  Heavy Duty Gas Springs/Self-Rising Lid
-  Rigid Structural Lid Bolster
-  RSL™ Beveled Edge Lid
-  Push Button Locks
-  Drill Resistant Push Button Locks
-  Bulb Shaped Weatherstripping



5 YR.
LIMITED WARRANTY

Clearcoat Catalog No.	Black Catalog No.	Size	A	B	C	D	E	F	G	Approx. Shipping Wt.
JAC1379980	JAC1379982	Fullsize Super Deep	70-1/8 in	60-1/8 in	22-1/2 in	14-7/8 in	20-1/4 in	21 in	71-7/8 in	80 lb
JAC1387980	JAC1387982	Fullsize Deep	70-1/8 in	60-1/8 in	19-1/2 in	12 in	20-1/4 in	21 in	72 in	87 lb
JAC1389980	JAC1389982	Fullsize Deep & Extra-Wide	70-1/8 in	60-1/8 in	19-1/2 in	12 in	29-1/4 in	30 in	72 in	98 lb
JAC1391980	—	Midsize	63-1/8 in	52-1/2 in	15-3/4 in	8-1/4 in	20-1/4 in	21 in	64-1/8 in	70 lb
JAC1570980	JAC1570982	Full Size, Low Profile	71 in	60.25 in	15 in	9-1/2 in	20-1/8 in	21 in	71-3/4 in	76.5 lb

ALUMINUM SINGLE LID CROSSOVERS

JOBBOX Aluminum Single Lid Crossovers provide superior security for tools and equipment. The combination of our Gear-Lock™ Locking System, RSL™ Rigid Structural Lid and our high-strength body that will resist over 1,000 pounds of prying force, your equipment has never been safer.



-  GearLock™ Locking System
-  Dual Rotary GearLock II™ Locking System
-  Self Aligning Latch Pins
-  Self Aligning Latch Hoops
-  Gas Spring Guards
-  Heavy Duty Gas Springs/Self-Rising Lid
-  Rigid Structural Lid Bolster
-  RSL™ Deep Beveled Edge Lid
-  Push Button Locks
-  Drill Resistant Push Button Locks
-  Bulb Shaped Weatherstripping

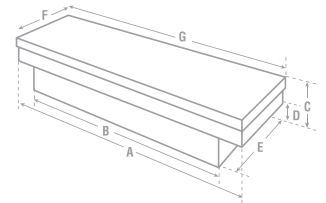
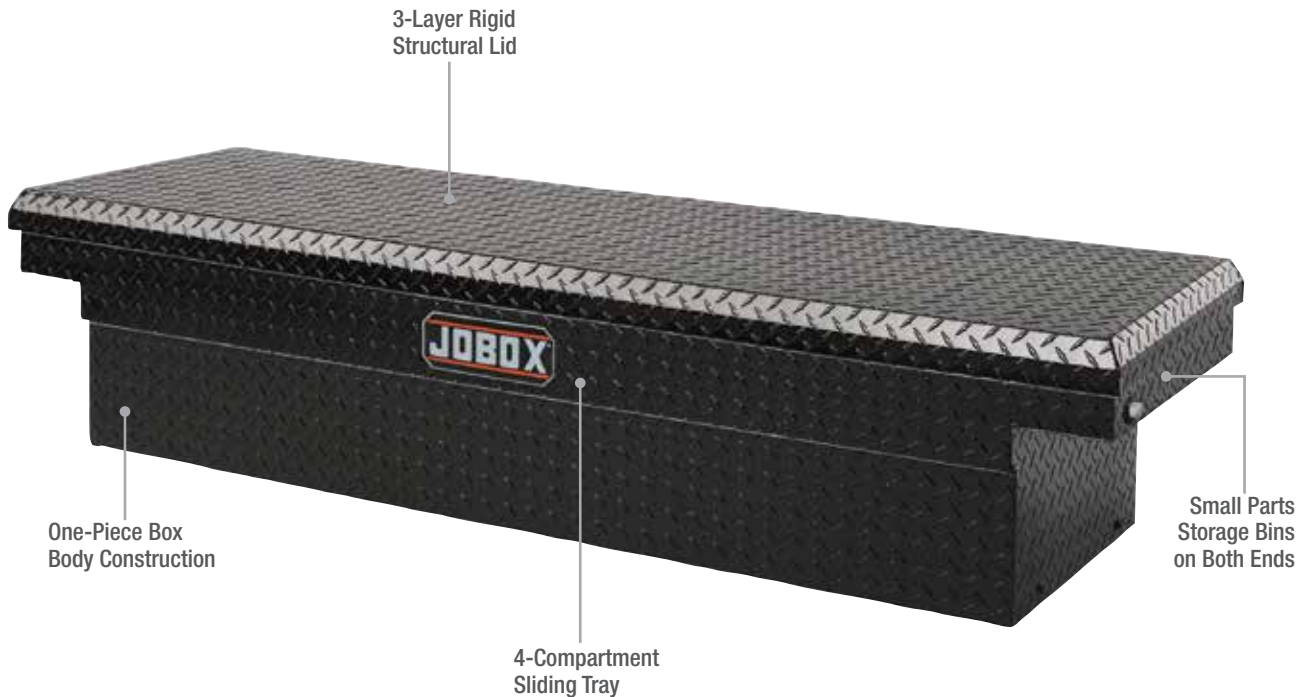









Bright Catalog No.	Black Catalog No.	Size	A	B	C	D	E	F	G	Approx. Shipping Wt.
PAC1357000	PAC1357002	Full Size, Low Profile	70 in	60-1/4 in	15-1/8 in	12-1/8 in	17-7/8 in	21 in	71-1/8 in	76.5 lb
PAC1580000	PAC1580002	Fullsize	70-1/8 in	60-1/8 in	14-1/4 in	9 in	20-1/4 in	20-7/8 in	71 in	76.5 lb
PAC1582000	PAC1582002	Deep Fullsize	70-1/8 in	60-1/8 in	17-1/4 in	12 in	20-1/4 in	20-7/8 in	71 in	80 lb
PAC1585000	PAC1585002	Super Deep Fullsize	70-1/8 in	60-1/8 in	19-7/8 in	14-5/8 in	20-1/4 in	21 in	71 in	83 lb
PAC1587000	PAC1587002	Compact	60-1/8 in	50-1/8 in	11-1/4 in	6 in	20-1/4 in	20-7/8 in	61 in	69 lb
PAC1589000	PAC1589002	Mid-Size	62-5/8 in	52-5/8 in	13-5/8 in	8-3/8 in	20-1/4 in	20-7/8 in	63-1/2 in	73 lb

STEEL SINGLE LID CROSSOVERS

JOBBOX Professional Steel Crossovers are as tough as they get. Gear-Lock II™ Rotary Lock System self-aligns and ratchets the lid firmly against the weatherproof seal, providing resistance to prying and pull force of over 2,000 pounds. Single lid for the best access to inside of the box, as well as accommodating large and long items. In addition, users now have increased visibility with the new lower profile design.



-  GearLock™ Locking System
-  Dual Rotary GearLock II™ Locking System
-  Self Aligning Latch Pins
-  Self Aligning Latch Hoops
-  Gas Spring Guards
-  Heavy Duty Gas Springs/Self-Rising Lid
-  Rigid Structural Lid Bolster
-  RSL™ Beveled Edge Lid
-  Push Button Locks
-  Drill Resistant Push Button Locks
-  Bulb Shaped Weatherstripping

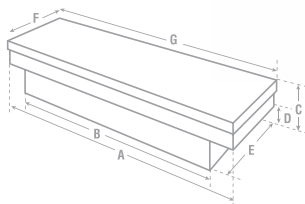

White Catalog No.	Black Catalog No.	Size	A	B	C	D	E	F	G	Approx. Shipping Wt.
JSC139590	—	Fullsize Deep	74 in	63 in	18-7/8 in	12 in	29-1/4 in	30 in	74-7/8 in	162 lb
JSC1394980	JSC1394982	Fullsize Deep	70-1/8 in	60-1/2 in	19-1/4 in	12 in	20-1/4 in	21 in	72 in	156 lb
JSC1396980	JSC1396982	Fullsize Deep, Extra-Wide	70-1/8 in	60-1/8 in	19-1/4 in	12 in	29-1/4 in	30 in	72 in	191 lb
JSC1397980	—	Compact	61 in	50 in	19-3/8 in	6 in	20-1/4 in	21 in	61-7/8 in	156 lb
JSC1580980	JSC1580982	Full Size, Low Profile	71 in	60-1/4 in	15	9-1/2 in	20-1/8 in	21 in	71-3/4 in	146 lb

STEEL SINGLE LID CROSSOVERS

JOBBOX Single Lid Steel Crossovers provide superior security for tools and equipment. The combination of our Gear-Lock™ System, reinforced lids and our high-strength body, will resist up to 1,000 pounds of prying force to break in.

-  GearLock™ Locking System
-  Dual Rotary GearLock II™ Locking System
-  Self Aligning Latch Pins
-  Self Aligning Latch Hoops
-  Gas Spring Guards
-  Heavy Duty Gas Springs/Self-Rising Lid
-  Rigid Structural Lid Bolster
-  RSL™ Beveled Edge Lid
-  Push Button Locks
-  Drill Resistant Push Button Locks
-  Bulb Shaped Weatherstripping

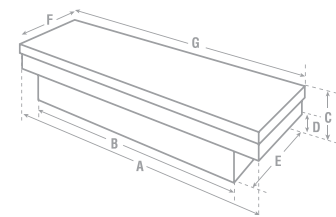
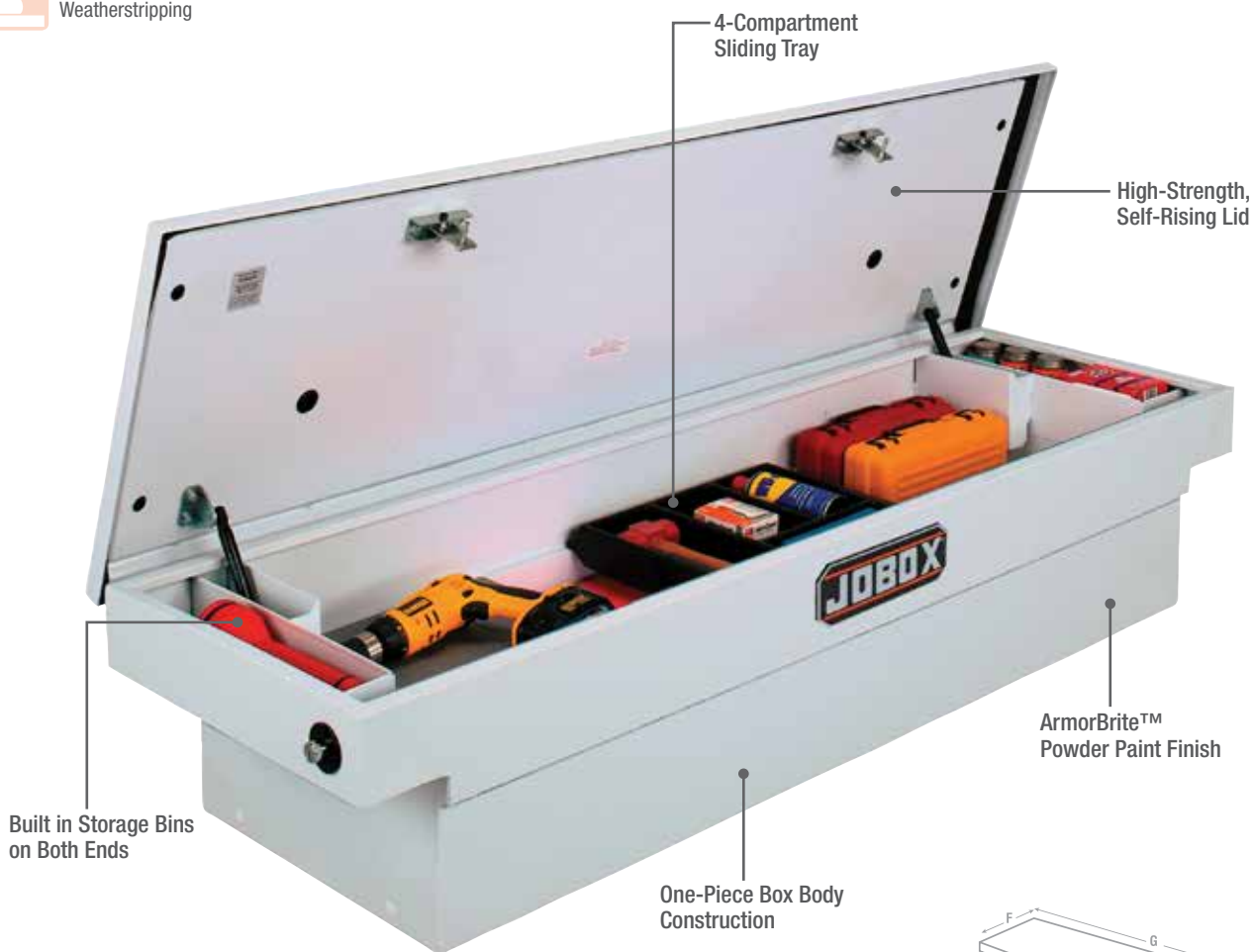









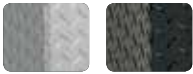



5 YR.
LIMITED
WARRANTY

White										Approx. Shipping Wt.
Catalog No.	Size	A	B	C	D	E	F	G		
PSC1455000	Fullsize	70-1/8 in	60-1/8 in	14-1/4 in	9 in	20-1/4 in	20-7/8 in	71 in		108 lb
PSC1456000	Fullsize Deep	70-1/8 in	60-1/8 in	17-1/4 in	12 in	20-1/4 in	20-7/8 in	71 in		101 lb
PSC1457000	Fullsize Deep, Extra-Wide	70-1/8 in	60-1/8 in	17-1/4 in	12 in	29-1/4 in	30 in	71 in		190 lb
PSC1458000	Compact	60-1/8 in	50-1/8 in	11-1/4 in	6 in	20-1/4 in	20-7/8 in	61 in		104 lb

ALUMINUM GULL WING CROSSOVERS

The JOBOX Professional Gull Wing Aluminum Crossovers offer the best unobstructed access from the sides of your truck. The superior one-piece body construction with a channel-reinforced front panel gives you the toughest box on the market.





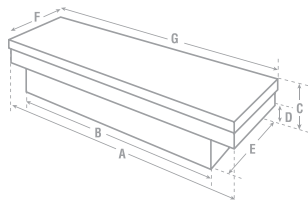
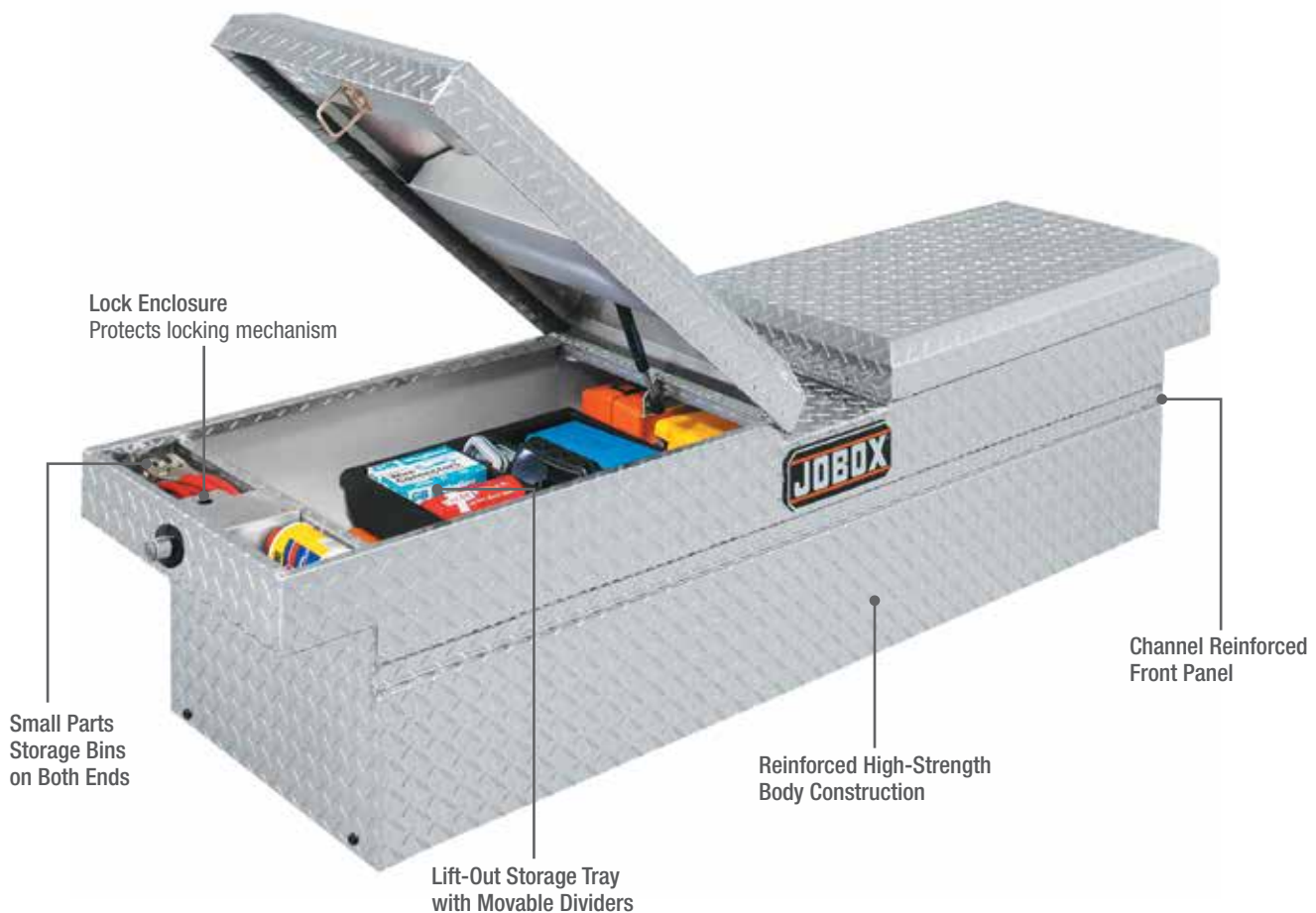





-  GearLock™ Locking System
-  Dual Rotary GearLock II™ Locking System
-  Self Aligning Latch Pins
-  Self Aligning Latch Hoops
-  Gas Spring Guards
-  Heavy Duty Gas Springs/Self-Rising Lid
-  Rigid Structural Lid Bolster
-  RSL™ Beveled Edge Lid
-  Push Button Locks
-  Drill Resistant Push Button Locks
-  Bulb Shaped Weatherstripping



Clearcoat	Black										Approx. Shipping Wt.
Catalog No.	Catalog No.	Size	A	B	C	D	E	F	G		
JAC1392980	JAC1392982	Fullsize Deep	70-1/8 in	60-1/8 in	19-3/8 in	12 in	20-1/4 in	21 in	72 in		71 lb
JAC1393980	—	Compact	60-1/4 in	50-1/8 in	13-3/8 in	7-1/2 in	20-1/4 in	21 in	62 in		50 lb

ALUMINUM GULL WING CROSSOVERS

The JOBBOX Dual Lid Aluminum Crossover offers the best unobstructed access from the sides of your truck. The high-strength body construction resists cargo damage and gives you long term durability.

-  GearLock™ Locking System
-  Self Aligning Latch Pins
-  Gas Spring Guards
-  Rigid Structural Lid Bolster
-  Push Button Locks
-  Bulb Shaped Weatherstripping
-  Dual Rotary GearLock II™ Locking System
-  Self Aligning Latch Hoops
-  Heavy Duty Gas Springs/Self-Rising Lid
-  RSL™ Beveled Edge Lid
-  Drill Resistant Push Button Locks

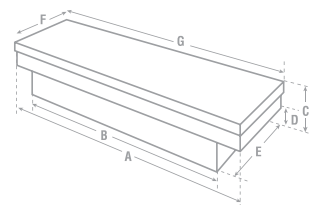











5 YR.
LIMITED WARRANTY

Catalog No.	Size	A	B	C	D	E	F	G	Approx. Shipping Wt.
PAC1596000	Fullsize	70-1/8 in	60-1/8 in	14-1/4 in	9 in	20-1/4 in	20-7/8 in	71 in	62.5 lb
PAC1597000	Compact	60-1/8 in	50-1/8 in	11-1/4 in	6 in	20-1/4 in	20-7/8 in	61 in	55 lb

STEEL GULL WING CROSSOVER

JOBBOX Professional Gull Wing Steel Crossovers make all of your equipment readily accessible at the push of a button, and offer clear and unobstructed access from the sides of your truck. The Armor-Brite™ powder paint finish provides unparalleled durability and corrosion resistance.



-  GearLock™ Locking System
-  Dual Rotary GearLock II™ Locking System
-  Self Aligning Latch Pins
-  Self Aligning Latch Hoops
-  Gas Spring Guards
-  Heavy Duty Gas Springs/Self-Rising Lid
-  Rigid Structural Lid Bolster
-  RSL™ Beveled Edge Lid
-  Push Button Locks
-  Drill Resistant Push Button Locks
-  Bulb Shaped Weatherstripping

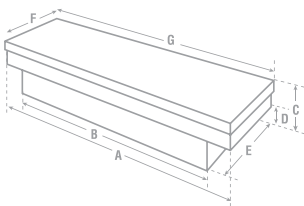

White	Black		A	B	C	D	E	F	G	Approx. Shipping Wt.
Catalog No.	Catalog No.	Size								
JSC1464980	JSC1464982	Fullsize Deep	70-1/8 in	60-1/8 in	19-1/4 in	12 in	20-1/4 in	21 in	72 in	146 lb

STEEL GULL WING CROSSOVER

JOBBOX Gull Wing Steel Crossovers provide superior security for tools and equipment. The combination of our Gear-Lock™ System, reinforced lids and high-strength body, they will resist up to 1,000 pounds of prying force to break in.



-  GearLock™ Locking System
-  Dual Rotary GearLock II™ Locking System
-  Self Aligning Latch Pins
-  Self Aligning Latch Hoops
-  Gas Spring Guards
-  Heavy Duty Gas Springs/Self-Rising Lid
-  Rigid Structural Lid Bolster
-  RSL™ Beveled Edge Lid
-  Push Button Locks
-  Drill Resistant Push Button Locks
-  Bulb Shaped Weatherstripping

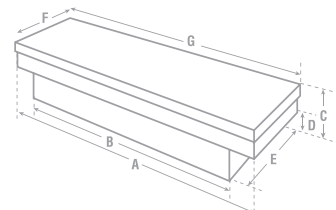
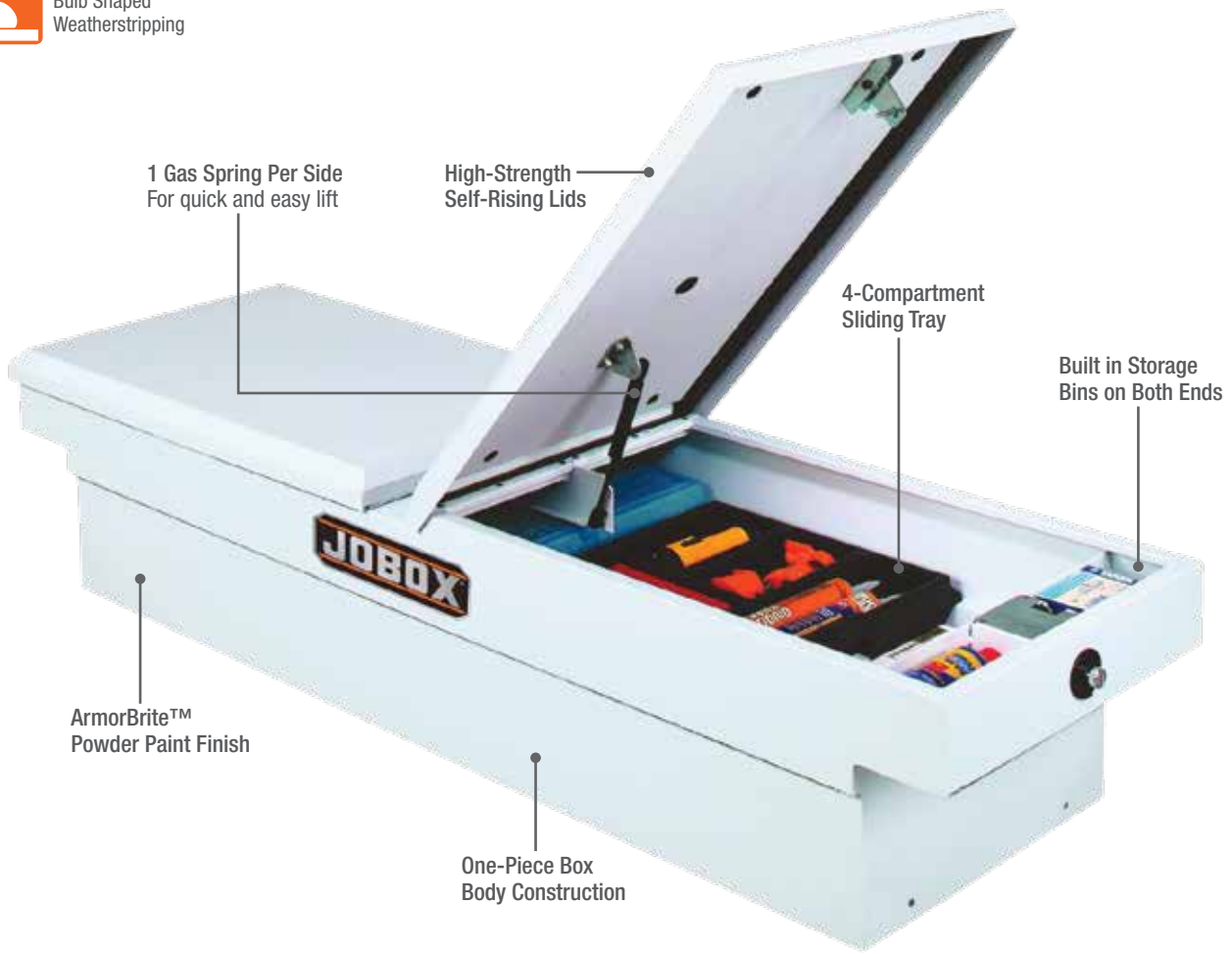

5 YR.
LIMITED WARRANTY











White	Black		A	B	C	D	E	F	G	Approx. Shipping Wt.
Catalog No.	Catalog No.	Size								
PSC1460000	PSC1460002	Fullsize	70-1/8 in	60-1/8 in	14-1/4 in	9 in	20-1/4 in	20-7/8 in	71 in	85 lb
PSC1461000	PSC1461002	Deep Fullsize	70-1/8 in	60-1/8 in	17-1/4 in	12 in	20-1/4 in	20-7/8 in	71 in	93 lb

ALUMINUM INNERSIDES

Available in standard and extra-wide models, JOBOX Professional Aluminum Innersides offer quick access to your tools and equipment with plenty of storage space. Self-aligning latch hoops guarantee a tight seal the first time, and every time the lid is closed.



Includes Support Legs and Mounting Kit

-  GearLock™ Locking System
-  Dual Rotary GearLock II™ Locking System
-  Self Aligning Latch Pins
-  Self Aligning Latch Hoops
-  Gas Spring Guards
-  Heavy Duty Gas Springs/Self-Rising Lid
-  Rigid Structural Lid Bolster
-  RSL™ Beveled Edge Lid
-  Push Button Locks
-  Drill Resistant Push Button Locks
-  Bulb Shaped Weatherstripping



Full-Length Storage Bin



Reinforced High-Strength Body Construction

Low Profile Lid For better visibility

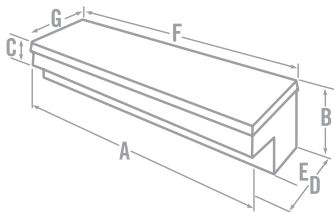

Clearcoat Catalog No.	Black Catalog No.	Size	A	B	C	D	E	F	G	Approx. Shipping Wt.
JAN1444980	JAN1444982	47 in	46 in	13-3/4 in	6-7/8 in	14-3/4 in	8-1/2 in	46-3/4 in	14-3/8 in	36.5 lb
JAN1445980	JAN1445982	58 in	57 in	13-3/4 in	6-7/8 in	14-3/4 in	8-1/2 in	57-3/4 in	14-3/8 in	41.5 lb

ALUMINUM INNERSIDES

-  GearLock™ Locking System
-  Dual Rotary GearLock II™ Locking System
-  Self Aligning Latch Pins
-  Self Aligning Latch Hoops
-  Gas Spring Guards
-  Heavy Duty Gas Springs/Self-Rising Lid
-  Rigid Structural Lid Bolster
-  RSL™ Beveled Edge Lid
-  Push Button Locks
-  Drill Resistant Push Button Locks
-  Bulb Shaped Weatherstripping

JOBBOX Aluminum Innersides utilize the same Gear-Lock™ System, Self-Centering Latch Pin, RSL™ Lid and High-Strength Body Design as the Crossovers. They mount on top of the bed sidewalls and are ideal for storing longer tools and equipment. Innersides help keep the bed free for storing bulky items. Combine Innersides with a Crossover to create a wrap-around storage system.



Includes Support Legs and Mounting Kit

Full-Length Storage Bin

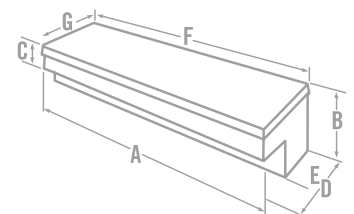

Bright	Black		A	B	C	D	E	F	G	Approx. Shipping Wt.
Catalog No.	Catalog No.	Size								
PAN1441000	PAN1441002	48 1/2" Long Lid	47-3/4 in	11 in	5-3/8 in	12-1/8 in	7-7/8 in	48-1/2 in	13 in	28.5 lb
PAN1442000	PAN1442002	58 1/2" Long Lid	57-3/4 in	11 in	5-3/8 in	12-1/8 in	7-7/8 in	58-1/2 in	13 in	32 lb

STEEL INNERSIDES

Designed for security and quick access in mind, JOBOX Professional Innersides provide easy access to your tools and equipment along the bedrail of your truck. Full-length, internal storage bin allows organization of small parts and tools. Use in conjunction with crossovers for maximum storage capacity and access.



Includes Support Legs and Mounting Kit



Full-Length Storage Bin

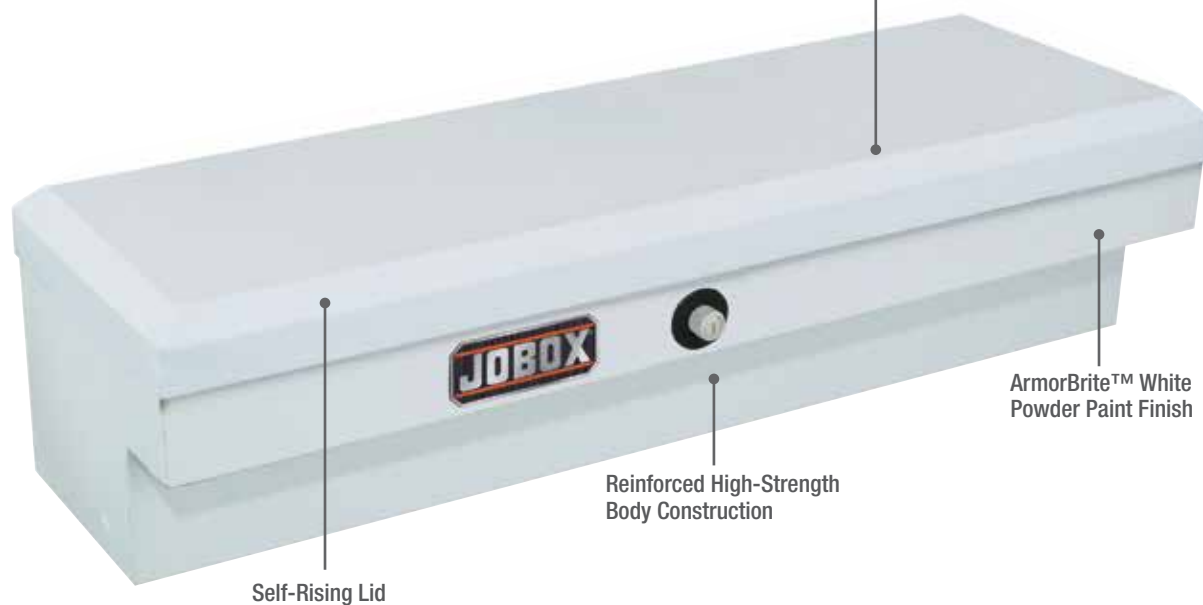

GearLock™ Locking System



Dual Rotary GearLock II™ Locking System



Self Aligning Latch Pins



Self Aligning Latch Hoops



Gas Spring Guards



Heavy Duty Gas Springs/Self-Rising Lid



Rigid Structural Lid Bolster



RSL™ Beveled Edge Lid



Push Button Locks



Drill Resistant Push Button Locks



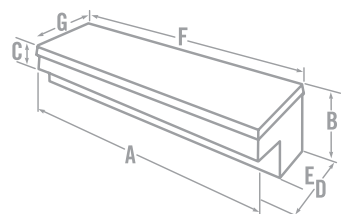

Bulb Shaped Weatherstripping



Catalog No.	Size	A	B	C	D	E	F	G	Approx. Shipping Wt.
JSN1505980	47 in	46 in	13-5/8 in	6-7/8 in	14-5/8 in	8-1/2 in	46-1/2 in	14-1/8 in	74.5 lb
JSN1506980	58 in	57 in	13-5/8 in	6-7/8 in	14-5/8 in	8-1/2 in	57-1/2 in	14-1/8 in	86.5 lb
JSN1507980	86 in	85 in	13-5/8 in	6-7/8 in	14-5/8 in	8-1/2 in	85-1/2 in	14-1/8 in	116 lb

STEEL INNERSIDES

Designed for security and quick access in mind, JOBOX Innersides provide easy access to your tools and equipment along the bedrail of your truck. Full-length, internal storage bin allows organization of small parts and tools. Use in conjunction with crossovers for maximum storage capacity and access.

-  GearLock™ Locking System
-  Dual Rotary GearLock II™ Locking System
-  Self Aligning Latch Pins
-  Self Aligning Latch Hoops
-  Gas Spring Guards
-  Heavy Duty Gas Springs/Self-Rising Lid
-  Rigid Structural Lid Bolster
-  RSL™ Beveled Edge Lid
-  Push Button Locks
-  Drill Resistant Push Button Locks
-  Bulb Shaped Weatherstripping



Includes Support Legs and Mounting Kit

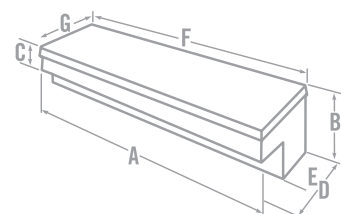
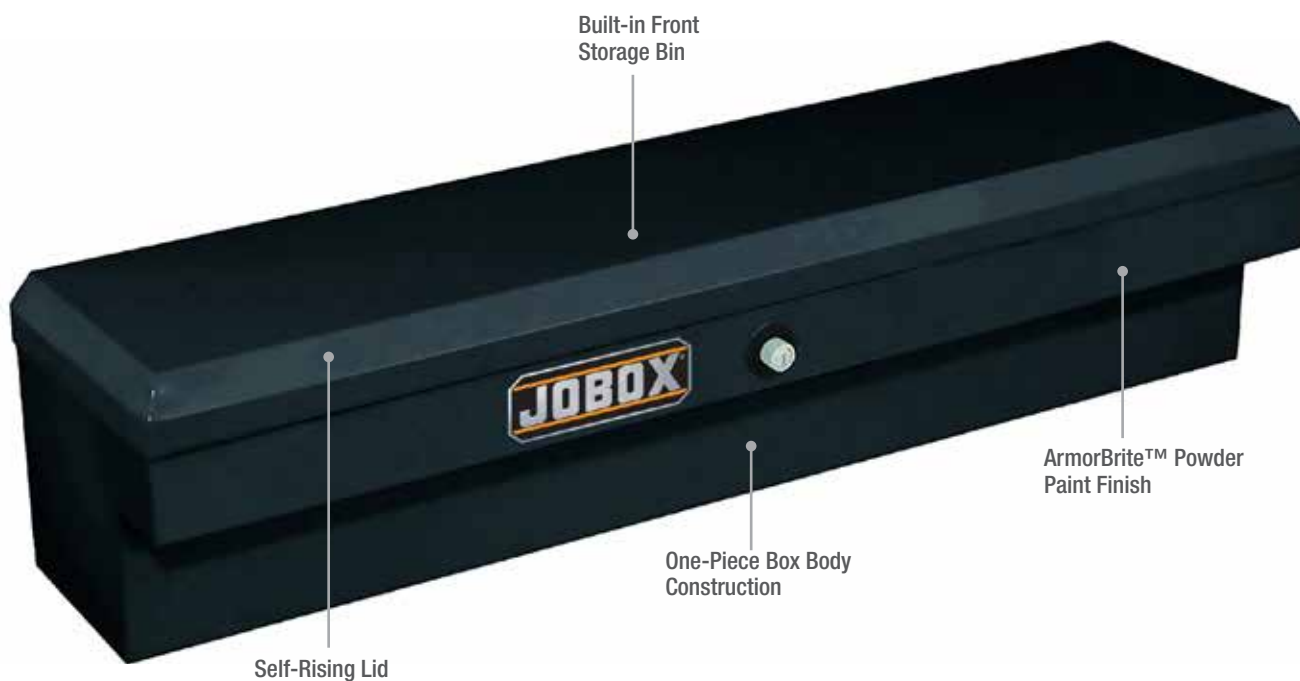

White	Black								Approx. Shipping Wt.
Catalog No.	Catalog No.	Length (A)	B	C	D	E	F	G	
PSN1451000	PSN1451002	47-1/2 in	11-1/8 in	5-3/8 in	12-1/4 in	8-1/4 in	47-1/2 in	12 in	55 lb
PSN1452000	PSN1452002	58-1/2 in	11-1/8 in	5-3/8 in	12-1/4 in	8-1/4 in	58-1/2 in	12 in	65 lb

Aluminum Bright Finish Model # Steel White Finish Model # Aluminum Black Finish Model #		ALUMINUM CROSSOVERS				
		Single Lid Super Deep Fullsize	Single Lid Deep Fullsize	Single Lid Deep Super-Duty & Ram	Single Lid Deep & Extra-Wide Fullsize	
		JAC1379980 JAC1379982	JAC1387980 JAC1387982	JAC1388980 JAC1388982	JAC1389980 JAC1389982	
Chevrolet & GMC Trucks						
1978-2011 Silverado/Sierra 1500	Regular Cab with Standard/Long Bed	•	•		•	
	Extended Cab with Short Bed	•	•			
2011 Silverado/Sierra 1500	Crew Cab with Short Bed	•	•			
2011 Silverado/Sierra 2500/3500	All Cabs with All Lengths Beds	•	•		•	
2002-2011 Colorado/Canyon	Regular Cab with Regular/Extended Cab Bed					
	Extended Cab with Regular/Extended Cab Bed					
2004-2011 Colorado/Canyon	Crew Cab with Crew Cab Bed					
2012-2013 Silverado/Sierra 1500	Regular Cab with Standard/Long Bed	•	•	•		
	Extended Cab with Short Bed	•	•	•		
	Crew Cab with Short Bed	•	•	•		
2012-2013 Silverado/Sierra 2500/3500	Extended Cab with All Lengths Bed	•	•	•		
	Regular/Crew Cab with All Lengths Bed	•	•	•	•	
2014 Silverado 1500	Regular Cab with Standard/Double Bed	•	•	•		
2014 Silverado 2500 HD	Crew Cab with Standard Bed	•	•	•		
2015 Silverado 1500	Double/Crew Cab with Short/Standard Bed	•	•	•	•	
2015 Silverado 2500/3500	Double/ Crew Cab with Standard/DRW/Long Bed	•	•	•	•	
Dodge Trucks						
2011 Ram 1500	Regular Cab with Standard/Long Bed	•	•	•		
	Quad Cab with Standard Bed	•	•	•		
2011 Ram 2500/3500	Regular/Mega/Crew Cab with Standard Bed	•	•	•		
2011 Dakota	Club Cab with Standard Bed					
	Quad Cab with Standard Bed					
2012-2013 Ram 1500	Regular Cab with Long Bed	•	•	•	•	
Ford Trucks						
2007-2011 Explorer	Sport-Trac Cab with Standard Bed					
2011 F-150	Styleside Cab with Short 5.5' Bed		•		•	
	Styleside Cab with Standard 6.75' / Long 8' Bed	•	•		•	
	Flareside Cab with Standard 6.5' Bed					
2011 F-250, F-350	Styleside Cab with Standard 6.75' / Long 8' Bed	•	•		•	
1987-2011 Ranger	Regular Cab with Standard/Long Bed					
2001-2011 Ranger	Super Cab with Standard/Long Bed					
2012-2013 F-150	Regular Cab with Short 5.5' Bed		•			
	Super Cab with Standard 6.5' Bed		•			
2012-2013 F-250, F-350	Regular/Crew Cab with Standard 6.75' / Long 8' Bed	•	•	•		
2014 F-150	Super Cab (4x2)/Regular Cab (4x2) with Standard Bed		•		•	
	Super Crew (4x4) with Standard Bed		•			
2014 F-250	Super Crew Raptor with Standard Bed		•			
2015 F-150	Super Crew Cab with 5 1/2 ft Box		•		•	
	Double Cab with Standard Bed					
Nissan Trucks						
2011 Titan	Crew Cab with Standard/Long Bed	•	•	•	•	
	King Cab with Standard/Long Bed		•		•	
2005-2011 Frontier	Crew/King Cab with Standard/Long Bed					
2012-2014 Titan	KC 4X2 Cab with Standard/Long Bed	•	•			
2014 Titan 4x4	Crew/King Cab with Standard/Long Bed	•	•			
2015 Frontier	Crew/King Cab with Short/Standard Bed					
Toyota Trucks						
2007-2011 Tundra	Regular/Double Cab with Standard/Long Bed	•	•		•	
	CrewMax Cab with Standard Bed		•		•	
2012-2013 Tundra	Double Cab with Standard Bed	•	•			
1989-2004 Tacoma	Regular Cab with Standard Bed					
2005-2011 Tacoma	Regular Cab with Standard Bed					
	Access Cab with Standard Bed					
	Double Cab with Standard/Long Bed					
2012-2014 Tacoma	Regular Cab with Standard Bed					
	Access Cab with Standard Bed					
	Double Cab with Standard/Long Bed					
2015 Tacoma	Double, Pre-Runner					
2015 Tundra	Double Cab with Standard Bed	•	•		•	
2015 Tundra	CrewMax Cab with Short Bed		•		•	

* Please go to JOBBOX.com to look up any vehicle not listed in this table.

Aluminum Bright Finish Model # Steel White Finish Model # Aluminum Black Finish Model #		ALUMINUM CROSSOVERS				
		Single Lid Super Deep Fullsize	Single Lid Deep Fullsize	Single Lid Fullsize	Single Lid Compact	
		PAC1585000 PAC1585002	PAC1582000 PAC1582002	PAC1580000 PAC1580002	PAC1587000 PAC1587002	
Chevrolet & GMC Trucks						
1978-2011 Silverado/Sierra 1500	Regular Cab with Standard/Long Bed	•	•	•		
	Extended Cab with Short Bed	•	•	•		
2011 Silverado/Sierra 1500	Crew Cab with Short Bed	•	•	•		
2011 Silverado/Sierra 2500/3500	All Cabs with All Lengths Beds	•	•	•		
2002-2011 Colorado/Canyon	Regular/Extended Cab with Regular/Extended Cab Bed				•	
2004-2011 Colorado/Canyon	Crew Cab with Crew Cab Bed				•	
2012-2013 Silverado/Sierra 1500	Regular Cab with Standard/Long Bed	•	•	•		
	Extended/Crew Cab with Short Bed	•	•	•		
2012-2013 Silverado/Sierra 2500/3500	Extended/Regular/Crew Cab Cab with All Lengths Bed	•	•	•		
2014 Silverado 1500	Regular Cab with Standard/Double Bed	•	•	•		
2014 Silverado 2500 HD/1500 4x4	Crew Cab with Standard Bed	•	•	•		
2015 Silverado 1500	Double/Crew Cab with Short/Standard Bed		•	•	•	
2015 Silverado 2500/3500	Double/Crew Cab with Standard/DRW/Long Bed	•	•	•	•	
Dodge Trucks						
2011 Ram 1500	Regular/Quad Cab with Standard/Long Bed	•		•		
2011 Ram 2500/3500	Regular/Mega/Crew Cab with Standard Bed	•	•	•		
2011 Dakota	Club/Quad Cab with Standard Bed				•	
2012-2013 Ram 1500	Regular/Express Quad/Longhorn Crew Cab with Standard Bed	•	•	•		
2012-2013 Ram 2500/3500	Regular/Mega/Crew Cab with Standard Bed			•		
2014-2015 Ram 1500/2500/3500	Crew/Mega/Bighorn/CC/QC Cab with Standard/Long Bed			•		
Ford Trucks						
2007-2011 Explorer	Sport-Trac Cab with Standard Bed					
2011 F-150	Styleside Cab with Short 5.5' Bed		•	•		
	Styleside Cab with Standard 6.75' / Long 8' Bed	•	•	•		
	Flareside Cab with Standard 6.5' Bed					
2011 F-250, F-350	Styleside Cab with Standard 6.75' / Long 8' Bed	•	•	•		
1987-2011 Ranger	Regular Cab with Standard/Long Bed				•	
2001-2011 Ranger	Super Cab with Standard/Long Bed				•	
2012-2013 F-150	Regular Cab with Short 5.5' Bed		•	•		
	Super Cab with Standard 6.5' Bed		•	•		
2012-2013 F-250, F-350	Regular/Crew Cab with Standard 6.75' / Long 8' Bed	•	•	•		
2014 F-150	Super Cab (4x2)/Regular Cab (4x2) with Standard Bed		•	•		
	Super Crew (4x4) with Standard Bed		•	•		
2014 F-250	Crew (4x4) Super Crew Raptor with Standard Bed	•	•	•		
2015 F-150	Super Crew Cab with 5 1/2 ft Box		•	•		
	Double Cab with Standard Bed					
Nissan Trucks						
2011 Titan	Crew Cab with Standard/Long Bed	•	•	•		
	King Cab with Standard/Long Bed		•			
2005-2011 Frontier	Crew/King Cab with Standard/Long Bed				•	
2012-2014 Titan	King Cab 4X2 Cab with Standard/Long Bed	•	•			
2014 Titan 4x4	Crew/King Cab with Standard/Long Bed	•	•			
2014 Frontier 4x2	Crew/King Cab w/Liner with Standard/Long Bed					
2015 Frontier	Crew/King Cab with Short/Standard Bed				•	
Toyota Trucks						
2007-2011 Tundra	Regular/Double Cab with Standard/Long Bed		•	•		
	CrewMax Cab with Standard Bed		•	•		
2012-2013 Tundra	Double Cab with Standard Bed	•	•	•		
1989-2004 Tacoma	Regular Cab with Standard Bed				•	
2005-2011 Tacoma	Regular Cab with Standard Bed					
	Access Cab with Standard Bed					
	Double Cab with Standard/Long Bed					
2012-2014 Tacoma	Regular Cab with Standard Bed					
	Access Cab with Standard Bed					
	Double Cab with Standard/Long Bed					
2015 Tacoma	Double, Pre-Runner					
2015 Tundra	Double Cab with Standard Bed	•	•	•	•	
2015 Tundra	CrewMax Cab with Short Bed		•	•	•	

* Please go to JOBBOX.com to look up any vehicle not listed in this table.

ALUMINUM TOPSIDES

JOBBOX Professional Aluminum Topside Boxes provide superior security and easy access. Topsides mount on top of the side walls to keep the bed free for bulky cargo. 3-Point locking system locks each door at the top and sides for greater security. Tall 12" door openings provide easy access to larger items, while the heavy-duty construction ensures long-term durability.

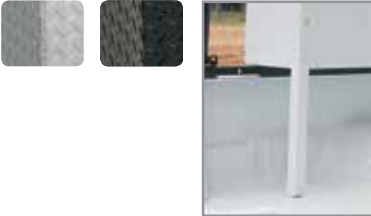

Includes Mounting Kit with Support Legs and Hardware

-  Quick Release Coated Cable
-  High Strength Door Cables
-  Push Button Lock
-  Drill Resistant Push Button Locks
-  3-Point Locking System
-  Rotating T-Handle
-  Bulb Shaped Weatherstripping

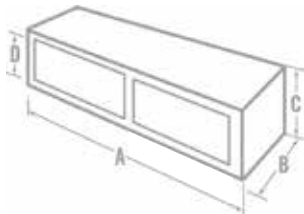

5 YR.
LIMITED WARRANTY

Bright	Black	Clearcoat					
Catalog No.	Catalog No.	Catalog No.	Length (A)	B	C	D	Approx. Shipping Wt.
570000	570002	570003	44 in	15 in	17 in	12-3/4 in	32 lb
571000D	571002D	571003D	65 in	15 in	17 in	12-3/4 in	50 lb
572000	572002D	572003	72 in	15 in	17 in	12-3/4 in	55 lb
573000	573002	573003	88 in	15 in	17 in	12-3/4 in	58 lb
574000D	574002D	574003D	96 in	15 in	17 in	12-3/4 in	63 lb

-  Quick Release Coated Cable
-  High Strength Door Cables
-  Push Button Lock
-  Drill Resistant Push Button Locks
-  3-Point Locking System
-  Rotating T-Handle
-  Bulb Shaped Weatherstripping

STEEL TOPSIDES

JOBBOX Professional Steel Topside Boxes provide superior security and easy access. Topsides mount on top of the side walls to keep the bed free for bulky cargo. 3-point locking system locks each door at the top and sides for greater security. Tall 12" door openings provide easy access to larger items, while the heavy-duty construction ensures long-term durability.



Includes Mounting Kit with Support Legs and Hardware



Tough Armor-Brite™ Powder Paint Finish

Reinforced Rain Gutter Door Frames

Heavy-Duty Hinges

Quick Release Coated Aircraft Cables Allow door to drop down 180 degrees for full accessibility

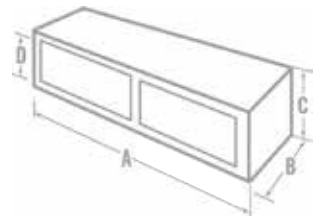

Catalog No.	Length (A)	B	C	D	Approx. Shipping Wt.
575000	44 in	15 in	17 in	12-3/4 in	72 lb
576000	65 in	15 in	17 in	12-3/4 in	107 lb
577000	72 in	15 in	17 in	12-3/4 in	118 lb
578000	88 in	15 in	17 in	12-3/4 in	140 lb
579000	96 in	15 in	17 in	12-3/4 in	146 lb

ALUMINUM & STEEL CHESTS

For unobstructed rear visibility and maximum storage space, chests are the best choice. These JOBOX Professional Chests are the toughest, most full-featured chests we make. The Gear-Lock II™ Rotary lock system self-aligns and ratchets the lid firmly against the weatherproof seal, providing resistance to prying and pull force of over 2,000 pounds.



-  GearLock™ Locking System
-  Dual Rotary GearLock II™ Locking System
-  Self Aligning Latch Pins
-  Self Aligning Latch Hoops
-  Gas Spring Guards
-  Heavy Duty Gas Springs/Self-Rising Lid
-  Rigid Structural Lid Bolster
-  RSL™ Beveled Edge Lid
-  Push Button Locks
-  Drill Resistant Push Button Locks
-  Bulb Shaped Weatherstripping

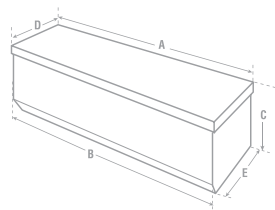

Clearcoat	Black	White								
Catalog No.	Catalog No.	Catalog No.	Size	A	B	C	D	E	Approx. Shipping Wt.	
JAH1426980	JAH1426982	—	60 in Aluminum	59-3/8 in	58-1/2 in	19 in	20-5/8 in	20-1/4 in	49 lb	
—	—	JSH1434980	60 in Steel	59-1/8 in	58-1/2 in	19 in	20-1/2 in	20-1/4 in	121 lb	



ALUMINUM CHESTS

JOBBOX Aluminum Chests provide superior security for tools and equipment. The combination of our Gear-Lock™ Dual Rotary Locking System, RSL™ Rigid Structural Lid, and High-Strength Body will resist over 1,000 pounds of prying force to break in.

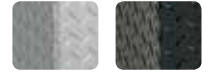



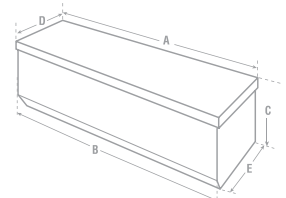
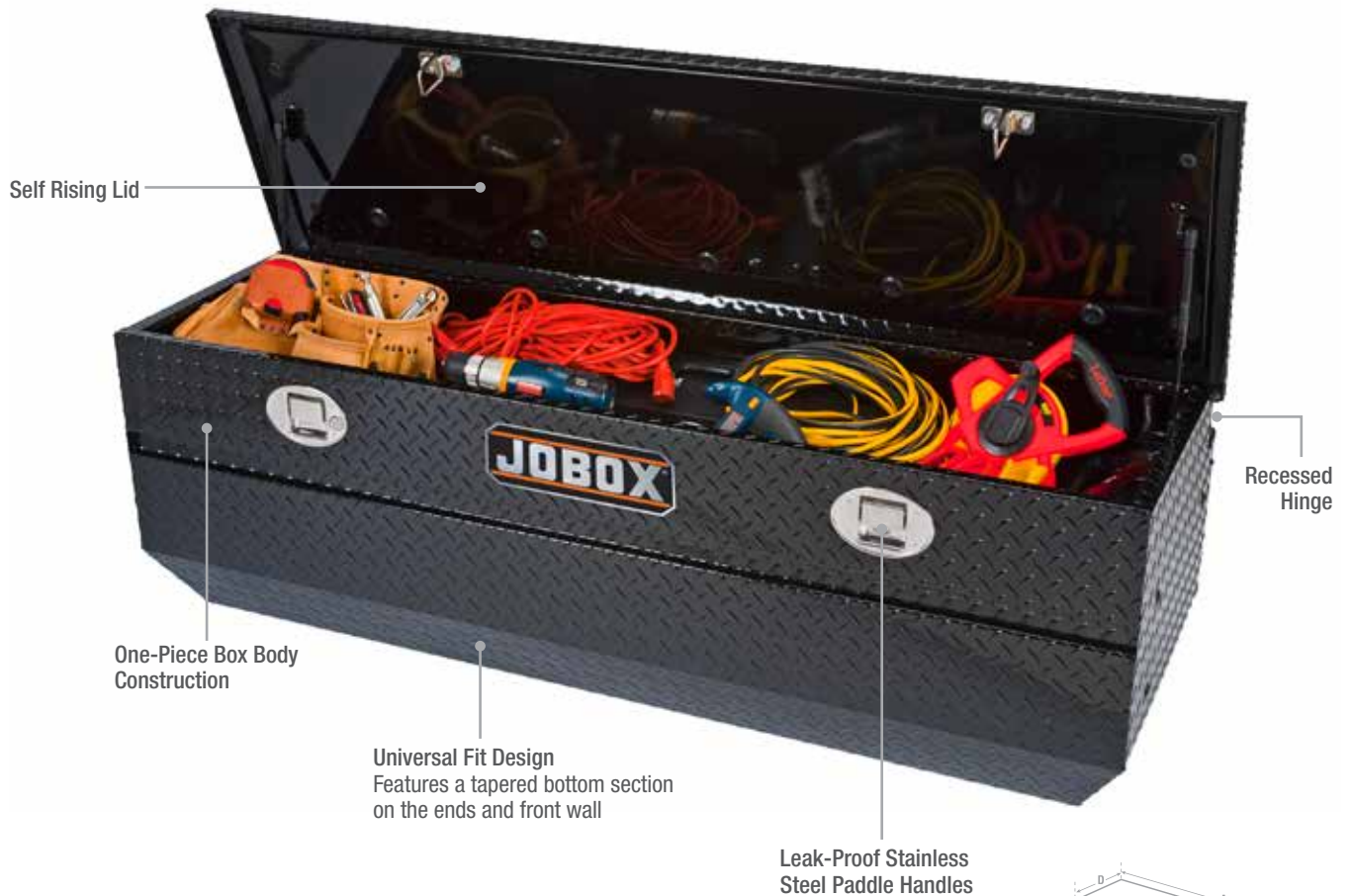







-  GearLock™ Locking System
-  Dual Rotary GearLock II™ Locking System
-  Self Aligning Latch Pins
-  Self Aligning Latch Hoops
-  Gas Spring Guards
-  Heavy Duty Gas Springs/Self-Rising Lid
-  Rigid Structural Lid Bolster
-  Push Button Locks
-  Drill Resistant Push Button Locks
-  Bulb Shaped Weatherstripping



Bright	Black		A	B	C	D	E	Approx. Shipping Wt.
Catalog No.	Catalog No.	Size						
PAH1420000	PAH1420002	SWB Fullsize	61 in	60-1/8 in	19-3/8 in	20-5/8 in	18-3/4 in	53 lb
PAH1421000	PAH1421002	Compact	46-7/8 in	46 in	16-1/4 in	17-5/8 in	14-7/8 in	45.5 lb
PAH1424000	PAH1424002	Extra-Wide Fullsize	61 in	60-1/8 in	19-3/8 in	27-5/8 in	24-7/8 in	68 lb

HEAVY-DUTY STEEL CHEST

For a clear rear view and maximum storage space, chests are the best choice. Our JOBOX Professional Heavy Duty Chest offers great features and value. Recessed hinges allow for full opening, even when placed against the truck bed wall. Leak proof stainless steel handles, hoop style strikers, and a full lid bolster provide security and strength.

-  GearLock™ Locking System
-  Dual Rotary GearLock II™ Locking System
-  Self Aligning Latch Pins
-  Self Aligning Latch Hoops
-  Gas Spring Guards
-  Heavy Duty Gas Springs/Self-Rising Lid
-  Rigid Structural Lid Bolster
-  RSL™ Beveled Edge Lid
-  Push Button Locks
-  Drill Resistant Push Button Locks
-  Bulb Shaped Weatherstripping



Recessed Hinge

Sliding Tray
For small parts and tools

Leak-Proof
Stainless Steel
Paddle Handles

Channel Reinforced
Front Panel





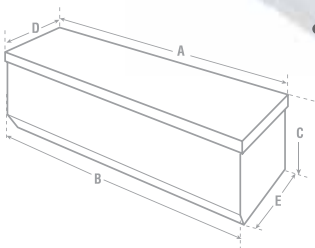

Reinforced High-Strength
Body Construction

Heavy-Duty Bottom Bolsters
Raise chest off truck bed



Catalog No.	Size	A	B	C	D	E	Approx. Shipping Wt.
817980	Fullsize Steel	59-1/8 in	58-1/2 in	19 in	20-1/2 in	20-1/8 in	129 lb
818980	Compact Steel	46-5/8 in	46 in	16-3/4 in	20-1/2 in	20-1/8 in	92 lb

RAIN GUTTER STYLE STEEL UNDERBED BOXES

-  Quick Release Coated Cable
-  High Strength Door Cables
-  Push Button Locks
-  Drill Resistant Push Button Locks
-  3-Point Locking System
-  Rotating T-Handle
-  Bulb Shaped Weatherstripping

JOBOX Rain Gutter Style Steel Underbed Boxes are built for protecting heavy tools and equipment in the toughest conditions. Industrial-grade steel hinges, quick release door connectors, and an extended rain gutter are just a few of the features that make JOBOX Underbeds the most secure and reliable on the market. Plus, the rugged one-piece lock housing helps protect the lock components and provides extra strength to the door.



5 YR.
LIMITED WARRANTY

White Catalog No.	Black Catalog No.	A	B	C	Approx. Shipping Wt.
790980	790982	24 in	18 in	18 in	68 lb
791980	791982	30 in	18 in	18 in	80 lb
792980	792982	36 in	18 in	18 in	92 lb
793980	793982	48 in	18 in	18 in	117 lb
794980	794982	60 in	18 in	18 in	142 lb

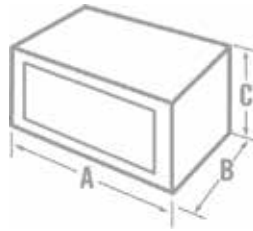

AVAILABLE FOR ALL UNDERBED BOXES:
MOUNTING BRACKETS

-  Heavy-Duty 2" C-Channel Brackets for Mounting Underbed Boxes
-  Brackets have Multiple Mounting Holes for Easy Installation
-  Sold in Pairs

Catalog No.	Size
228000	18" X 18"
229000	24" X 24"

ALUMINUM UNDERBED BOXES

Our JOBOX Professional Aluminum Underbed Boxes with heavy duty 0.100-gauge aluminum and continuous 3/8" diameter hinge, mixes strength and quality with a clean, professional appearance. A robust lock housing protects the lock components while loading equipment into the underbed box.



Quick Release Coated Cable



High Strength Door Cables



Push Button Lock



Drill Resistant Push Button Locks



3-Point Locking System



Rotating T-Handle



Bulb Shaped Weatherstripping



Extended Rain Gutter
Seals opening to prevent leakage or moisture

0.100-Gauge Aluminum



High-Strength Door with 3/8" Diameter Hinge

Reinforced Cam Lock with Fully Covered Lock Mechanism For increased durability

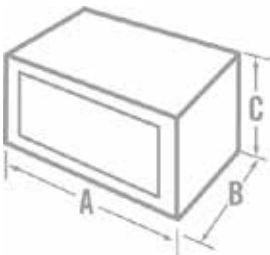







14" Tall Aluminum Underbed Box				Approx. Shipping Wt.
Catalog No.	A	B	C	
755980	24 in	12 in	14 in	25 lb
18" Tall Aluminum Underbed Boxes				
756980	18 in	18 in	18 in	35 lb
757980	24 in	18 in	18 in	40 lb
758980	30 in	18 in	18 in	44 lb
759980	36 in	18 in	18 in	48 lb
761980	48 in	18 in	18 in	61 lb
762980	60 in	18 in	18 in	74 lb



24" Tall Aluminum Underbed Boxes				Approx. Shipping Wt.
Catalog No.	A	B	C	
764980	24 in	24 in	24 in	56 lb
765980	30 in	24 in	24 in	60 lb
766980	36 in	24 in	24 in	65 lb
767980	48 in	24 in	24 in	82 lb
768980	60 in	24 in	24 in	98 lb

ALUMINUM UNDERBED BOXES

JOBBOX Aluminum Underbed Boxes are built for protecting heavy tools and equipment in the toughest conditions. Durable weather stripping forms a tight seal to prevent moisture from entering. 3-Point Locking System draws the door tight against the weather stripping surrounding the door opening, and locks the door at the top and on both sides.

-  Quick Release Coated Cable
-  High Strength Door Cables
-  Push Button Lock
-  Drill Resistant Push Button Locks
-  3-Point Locking System
-  Rotating T-Handle
-  Bulb Shaped Weatherstripping

Extended Rain Gutter
Seals opening to prevent leakage or moisture

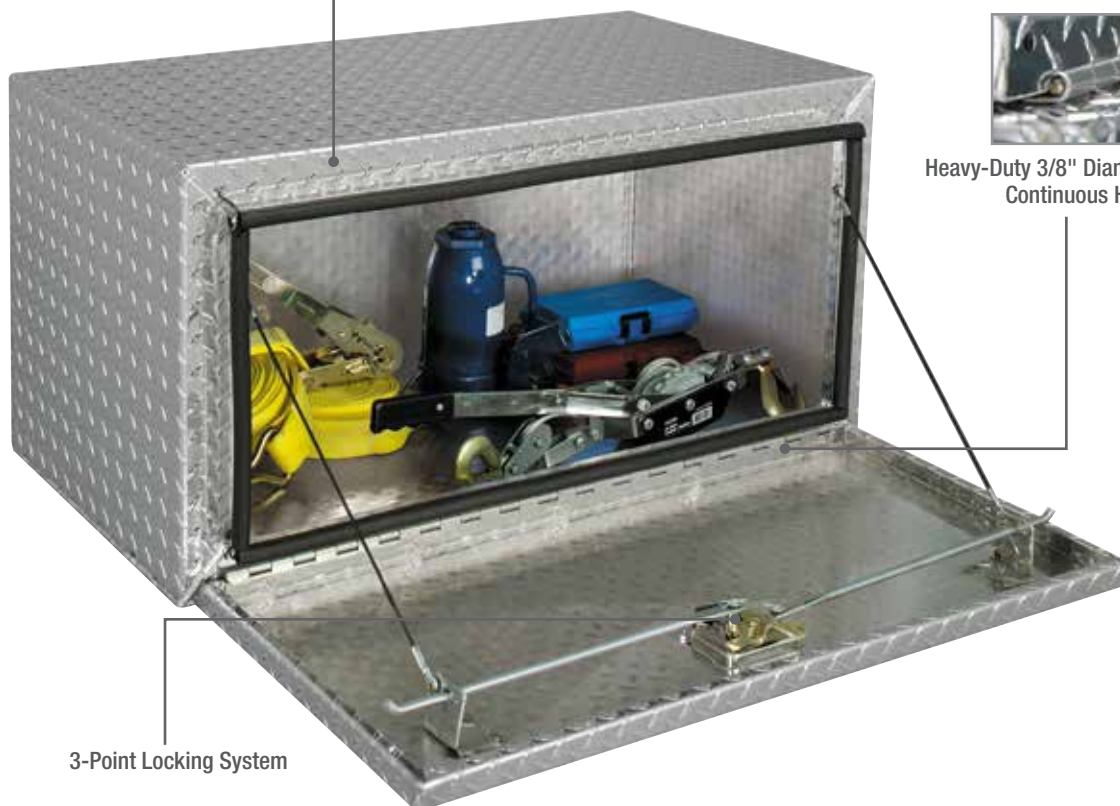

Heavy-Duty 3/8" Diameter Continuous Hinge

3-Point Locking System

AVAILABLE FOR ALL UNDERBED BOXES:

MOUNTING BRACKETS

-  Heavy-Duty 2" C-Channel Brackets for Mounting Underbed Boxes
-  Brackets have Multiple Mounting Holes for Easy Installation
-  Sold in Pairs

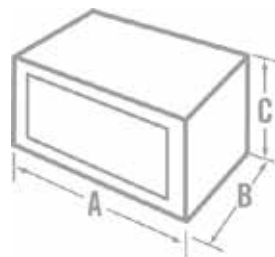

5 YR.
LIMITED WARRANTY

Catalog No.	A	B	C	Approx. Shipping Wt.
407000	24 in	18 in	18 in	40 lb
408000	36 in	18 in	18 in	48 lb
409000	48 in	18 in	18 in	61 lb

Catalog No.	Size
228000	18" X 18"
229000	24" X 24"

STEEL UNDERBED BOXES

Industrial-grade steel hinges, quick release door connectors, and an extended rain gutter are just a few features that make JOBBOX Professional Underbeds the most reliable and secure on the market. A rugged, one-piece lock housing helps protect the lock components and provides extra strength to the door.



Quick Release Coated Cable



High Strength Door Cables



Push Button Lock



Drill Resistant Push Button Locks



3-Point Locking System



Rotating T-Handle



Bulb Shaped Weatherstripping

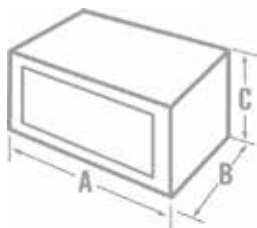

14" Tall Steel Underbed Boxes

Black		White			
Catalog No.	Catalog No.	A	B	C	Approx. Shipping Wt.
727982	—	24 in	12 in	14 in	49 lb
728982	—	36 in	12 in	14 in	67 lb
729982	—	24 in	16 in	14 in	55 lb
731982	—	36 in	16 in	14 in	76 lb

18" Tall Steel Underbed Boxes







732982	732980	18 in	18 in	18 in	55 lb
733982	733980	24 in	18 in	18 in	68 lb
734982	734980	30 in	18 in	18 in	80 lb
735982	735980	36 in	18 in	18 in	92 lb
738982	738980	48 in	18 in	18 in	117 lb
739982	739980	60 in	18 in	18 in	142 lb
740982	740980	72 in	18 in	18 in	168 lb

24" Tall Steel Underbed Boxes

Black		White			
Catalog No.	Catalog No.	A	B	C	Approx. Shipping Wt.
748982	—	24 in	24 in	24 in	94 lb
749982	—	30 in	24 in	24 in	110 lb
750982	—	36 in	24 in	24 in	126 lb
752982	—	48 in	24 in	24 in	158 lb
754982	—	60 in	24 in	24 in	190 lb



STEEL UNDERBED BOXES

-  Quick Release Coated Cable
-  High Strength Door Cables
-  Push Button Lock
-  Drill Resistant Push Button Locks
-  3-Point Locking System
-  Rotating T-Handle
-  Bulb Shaped Weatherstripping

JOBBOX Steel Underbed Boxes are built for protecting heavy tools and equipment in the toughest conditions. Durable weather stripping forms a tight seal to prevent moisture from entering. 3-Point Locking System draws the door tight against the weather stripping surrounding the door opening, and locks the door at the top and on both sides.



14-Gauge Industrial Grade Steel Construction

V-Groove Door Frame and beveled edge door create tight seal



Hinge Design Allows door to drop down when cables are detached

Lock Guard Reinforces the door for incredible strength

3-Point Locking System with Drill Resistant Lock

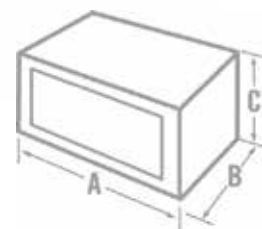



Black Catalog No.	White Catalog No.	A	B	C	Approx. Shipping Wt.
14" Tall x 12" Deep					
1-002002	1-002000	36 in	14 in	12 in	68 lb
18" Tall x 18" Deep					
1-003002	—	18 in	18 in	18 in	56.5 lb
1-004002	1-004000	24 in	18 in	18 in	70 lb
1-005002	1-005000	30 in	18 in	18 in	81 lb
1-006002	1-006000	36 in	18 in	18 in	91.5 lb
1-007002	1-007000	48 in	18 in	18 in	118 lb
1-008002	1-008000	60 in	18 in	18 in	142 lb
1-009002	1-009000	72 in	18 in	18 in	168 lb
24" Tall x 24" Deep					
1-012002	—	36 in	24 in	24 in	114 lb
1-013002	1-013000	48 in	24 in	24 in	148 lb

AVAILABLE FOR ALL UNDERBED BOXES:

MOUNTING BRACKETS



-  Heavy-Duty 2" C-Channel Brackets for Mounting Underbed Boxes
-  Brackets have Multiple Mounting Holes for Easy Installation
-  Sold in Pairs

Catalog No.	Size
228000	18" X 18"
229000	24" X 24"

STEEL TRAILER TONGUE BOX

JOBBOX Steel Trailer Tongue Boxes provide superior security and weather-tight storage. The deep recessed hinge allows the box to fully open when placed against a rail or trailer wall.





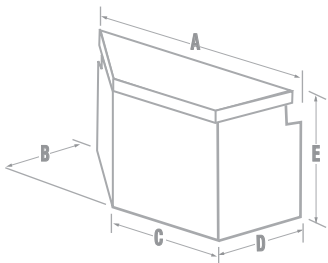





-  GearLock™ Locking System
-  Dual Rotary GearLock II™ Locking System
-  Self Aligning Latch Pins
-  Self Aligning Latch Hoops
-  Gas Spring Guards
-  Heavy Duty Gas Springs/Self-Rising Lid
-  Rigid Structural Lid Bolster
-  RSL™ Beveled Edge Lid
-  Push Button Locks
-  Drill Resistant Push Button Locks
-  Bulb Shaped Weatherstripping



White Catalog No.	Black Catalog No.	A	B	C	D	E	Approx. Shipping Wt.
422000	422002	32-7/8 in	16 in	20 in	16-1/4 in	21 in	72 lb
423000	423002D	48 in	18 in	25 in	18-1/4 in	21 in	97.5 lb

ALUMINUM TRAILER TONGUE BOX

JOBOX Aluminum Trailer Tongue Boxes provide superior security and weather-tight storage. Deep Recessed hinge allows the box to fully open when placed against a rail or trailer wall.

-  GearLock™ Locking System
-  Dual Rotary GearLock II™ Locking System
-  Self Aligning Latch Pins
-  Self Aligning Latch Hoops
-  Gas Spring Guards
-  Heavy Duty Gas Springs/Self-Rising Lid
-  Rigid Structural Lid Bolster
-  RSL™ Beveled Edge Lid
-  Push Button Locks
-  Drill Resistant Push Button Locks
-  Bulb Shaped Weatherstripping

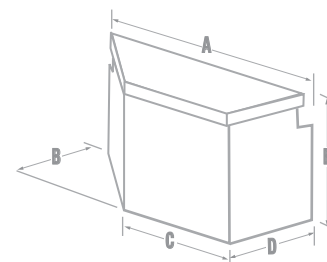
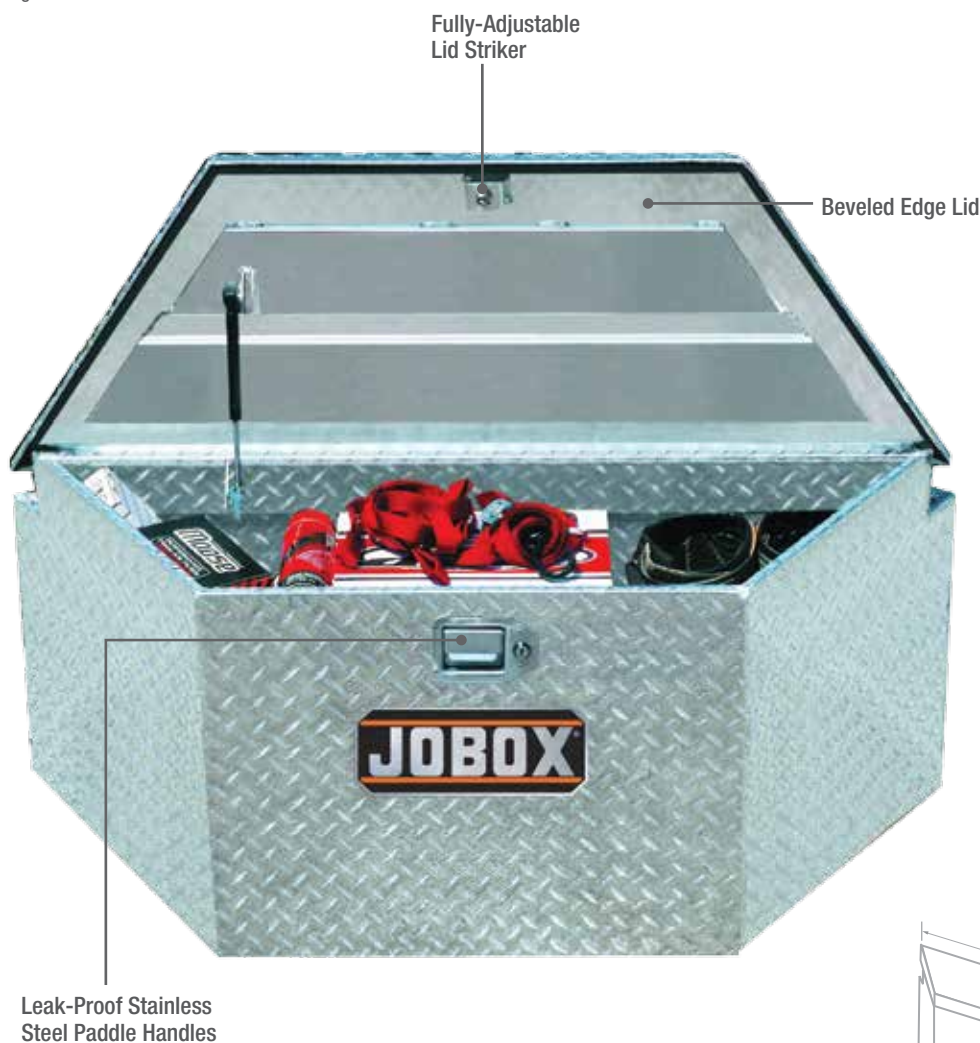

Bright	Black	A	B	C	D	E	Approx. Shipping Wt.
Catalog No. 415000D	Catalog No. 415002D	32-7/8 in	16 in	20 in	16-1/4 in	16 in	25.5 lb
416000	416002	48 in	18 in	25 in	18-1/4 in	18 in	33.5 lb

ALUMINUM DRAWER STORAGE

JOBBOX Professional Aluminum Drawer Storage is perfect for use in service vans, minivans, SUV's or motor home basements. Removable dividers allow for segmenting small and large tools, supplies, or parts. Heavy-gauge aluminum is light enough for easy mobility and transport, and durable enough to stand up to heavy loads on top of, and in, drawers.



- Extruded Heavy-Duty Drawer Glides support up to 75 lbs. per drawer
- Pins prevent the drawers from rolling off the glides
- Latches automatically lock the drawers when closed
- Moveable Dividers to create different size bins



0.125" Aluminum Tops
Support up to 200 lb. load
per square foot



Catalog No.	Description	Depth	Width	Height	Approx. Shipping Wt.
50" Long Floor Models With One, Two, Three or Four Drawers					
1401980	1-Drawer Floor Model	50 in	12 in	6 in	31 lb
1402980	2-Drawer Floor Model	50 in	24 in	6 in	61 lb
1403980	3-Drawer Floor Model	50 in	36 in	6 in	89 lb
1404980	4-Drawer Floor Model	50 in	48 in	6 in	119 lb
50" Long One-Drawer Stacked Models Two, Three or Four Drawers					
1407980	2-Drawer Stacked Model	50 in	12 in	12 in	59 lb
1408980	3-Drawer Stacked Model	50 in	12 in	18 in	85 lb
1409980 (shown, right)	4-Drawer Stacked Model	50 in	12 in	24 in	114 lb
26" Long Floor Model With Three Drawers					
1405980	3-Drawer Floor Model	26 in	36 in	6 in	51 lb
26" Long Stacked Model With Six Drawers					
1406980 (shown, left)	6-Drawer Floor Model	26 in	36 in	12 in	81 lb
Drawer Dividers					
1410980	Plastic Drawer Divider	-	-	-	0.2 lb

JOBBOX StorAll

STEEL DRAWER STORAGE



Up to 50% more Drawer Weight Capacity

- 650 lb. drawer weight capacity
- Drawer travels on 1,000 lb. rated rear roller bearings and 250 lb. rated front conveyor bearings
- 12-Gauge steel channels

14-Gauge Steel JOBBOX StorAll® drawer storage is designed to provide extreme durability and safety with unprecedented versatility. Perfect for work trucks, trailers and vans, StorAll® provides up to 50% more drawer weight capacity and up to 20% more storage capacity than competitive products. Drawers are customizable with adjustable front-to-rear dividers and bin dividers. Grip-And-Release™ system allows safe opening and closing of heavy drawers on sloped surfaces.

Steel Plunger Engages internal drawer stops

Built-In Rain Gutter Channel

Up to 20% more Storage Capacity

Both front-to-rear sectional dividers and bin dividers are adjustable for customizable storage.

Anti-Skid Strips

Steel Mounting Brackets Engage rear and center skids

Full Bulb-Shaped Automotive Weather Stripping

Recessed Drawer Front Protects handle from damage

Grip-And-Release™ Drawer Stop Safety System

Release handle and the drawer safely locks into position, allowing you to safely open and close heavy drawers on sloped surfaces.









Catalog No.	Body Width	No. of Compartments	No. of Section Dividers	No. of Galvanized Dividers	Approx. Shipping Wt.
9" Tall Drawer Units: All Models 48" Long With 5" Deep Drawer					
661980	12 in	1	0	7	140 lb
662980	24 in	2	1	13	202 lb
663980	36 in	3	2	19	282 lb
664980	48 in	4	3	24	374 lb
13" Tall Drawer Units: All Models 48" Long With 9" Deep Drawer					
665980	12 in	1	0	7	155 lb
666980	24 in	2	1	13	245 lb
667980	36 in	3	2	19	352 lb
668980	48 in	4	3	24	432 lb

ALUMINUM TRANSFER TANKS

JOBBOX Professional Aluminum Transfer Tanks are designed for the toughest conditions. All tanks are made with heavy-duty 0.125" treadplate aluminum and pressure-tested for leaks. The Fuel-n-Tool model 433000 offers the convenience of a 72-gallon transfer tank and 4.5 cubic feet of secure storage space all in one unit.



-  GearLock™ Locking System
-  Dual Rotary GearLock II™ Locking System
-  Self Aligning Latch Pins
-  Self Aligning Latch Hoops
-  Gas Spring Guards
-  Heavy Duty Gas Springs/Self-Rising Lid
-  Rigid Structural Lid Bolster
-  RSL™ Deep Beveled Edge Lid
-  Push Button Locks
-  Drill Resistant Push Button Locks
-  Bulb Shaped Weatherstripping

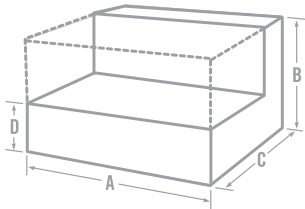
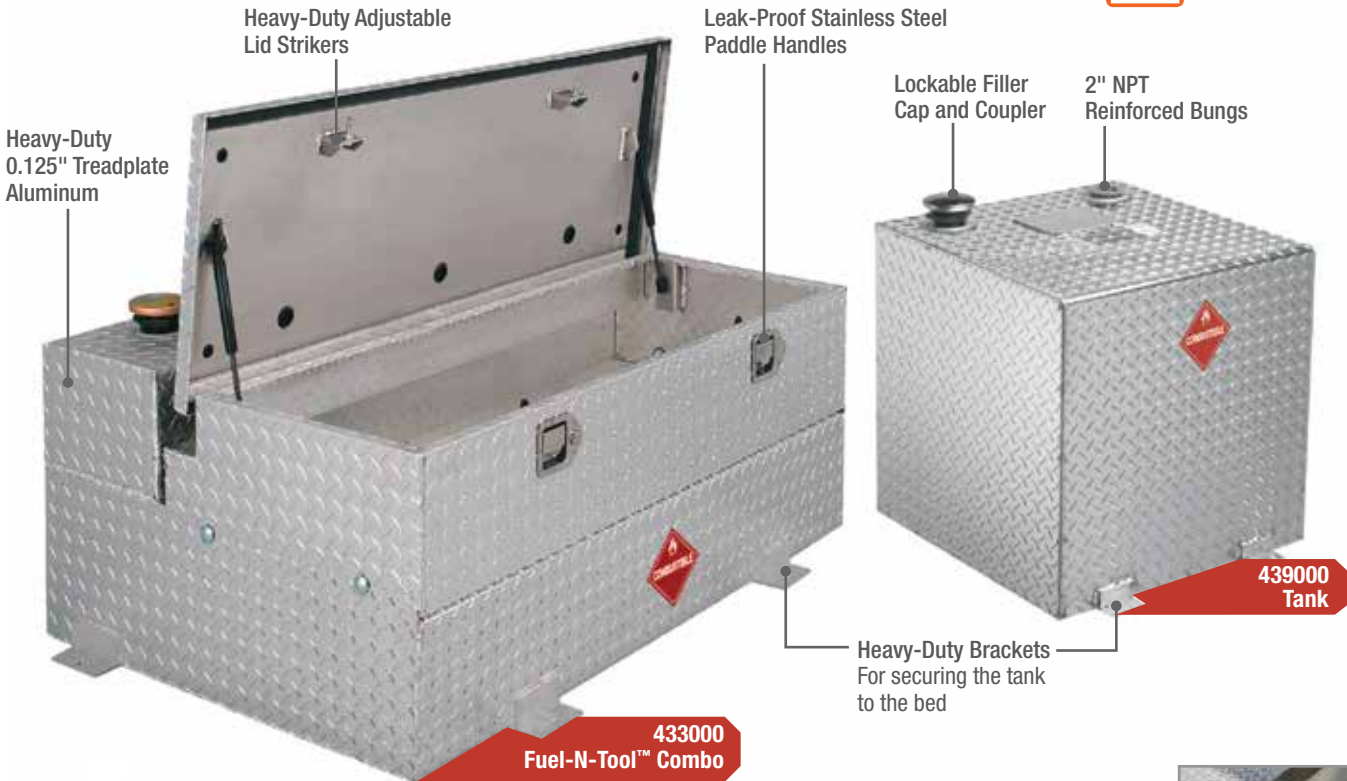

Center Baffles
Add extra strength and control flow of contents

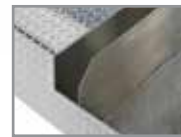

! The Safety Capacity is the MINIMUM capacity of the tank when filled to the bottom of the Bung Fill tube, not the maximum capacity of the tank.

Catalog No.	Shape	Safe Fill	Max Fill	A	B	C	D	Approx. Shipping Wt.
Fuel-N-Tool Combo Aluminum Transfer Tank								
433000	L-Shaped Tank	72 gal (US)	77 gal (US)	48-1/4 in	19 in	31 in	9 in	129 lb
Aluminum Liquid Transfer Tanks								
436000	L-Shaped	72 gal (US)	77 gal (US)	48-1/4 in	19 in	31 in	9 in	129 lb
437000	L-Shaped	99 gal (US)	104 gal (US)	54 in	25 in	31 in	9 in	112 lb
438000	Rectangular	91 gal (US)	102 gal (US)	45-1/4 in	23-1/4 in	23-1/4 in	-	94 lb
439000	Square	47 gal (US)	52 gal (US)	23-1/4 in	23-1/4 in	23-1/4 in	-	64 lb

STEEL TRANSFER TANKS



JOBBOX Professional Tanks feature 14-Gauge construction for long-term durability. Internal baffles reinforce the high-strength design and control the flow of the contents when moving. Model 498000 and 498002 Transfer Tanks are made for short bed trucks — including trucks with 4-door cabs. The unique design has extended sides above both wheel wells to increase the capacity. All tanks are pressure tested for leaks.

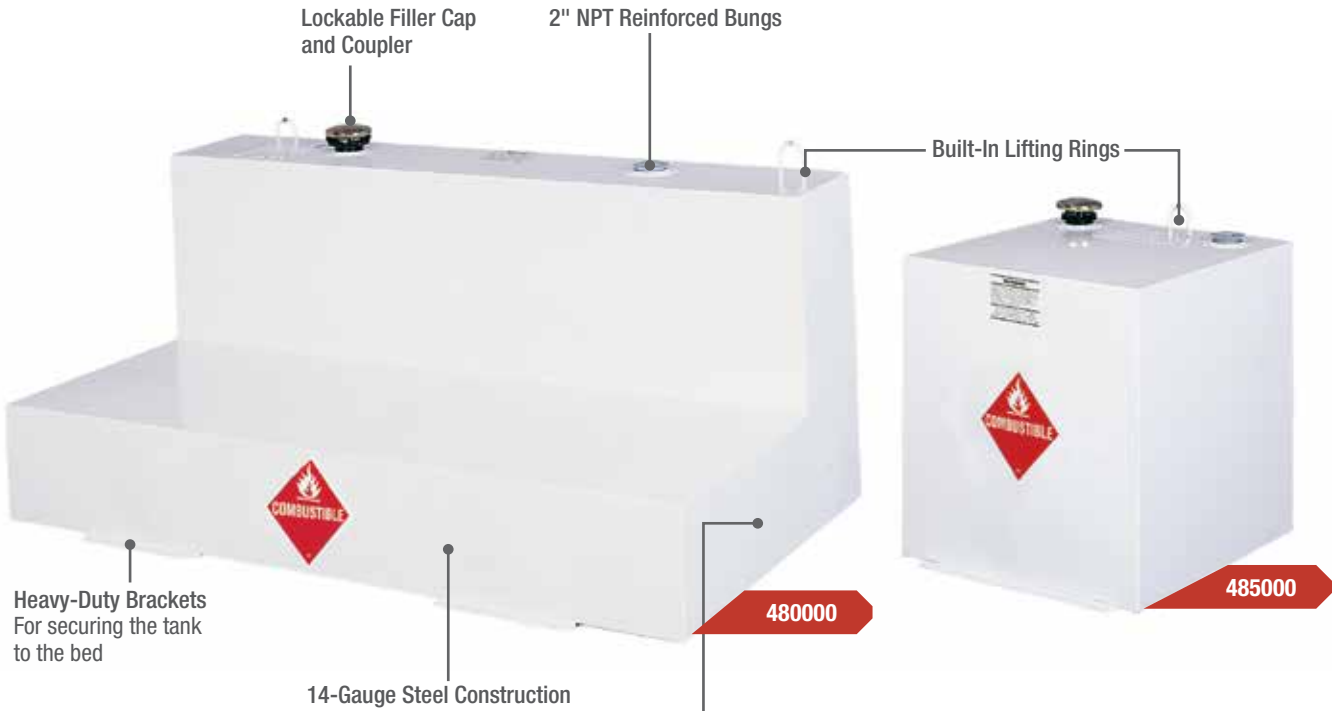

Center Baffles
Add extra strength and control flow of contents

Safety Fill Capacity
Allows space for the contents to expand in warm weather

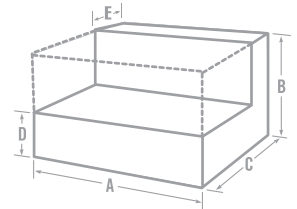

! The Safety Capacity is the MINIMUM capacity of the tank when filled to the bottom of the Bung Fill tube, not the maximum capacity of the tank.

White Catalog No.	Black Catalog No.	Description	Safe Fill	Max Fill	A	B	C	D	E	Approx. Shipping Wt.
480000	480002	L-Shaped	103 gal (US)	109 gal (US)	54 in	25 in	31 in	9 in	11 in	200.0 lb
482000	—	L-Shaped	51 gal (US)	54 gal (US)	27 in	25 in	31 in	9 in	10 in	106.0 lb
484000	484002	Rectangle	96 gal (US)	107 gal (US)	45-5/8 in	24 in	23-1/4 in	-	-	140.0 lb
485000	—	Square	50 gal (US)	55 gal (US)	23-1/4 in	24 in	23-1/4 in	-	-	85.5 lb
486000	—	Vertical (F-N-T Ready)	37 gal (US)	42 gal (US)	54 in	19 in	9 in	-	-	97.0 lb
488000	488002	Low-Profile L-Shaped	76 gal (US)	82 gal (US)	46 in	25 in	31 in	6-1/2 in	11 in	155.0 lb
498000	498002	L-Shaped (F-N-T Ready)	98 gal (US)	106 gal (US)	60-1/4 in	25 in	33 in	7-1/2 in	13 in	175.0 lb

STEEL FUEL-N-TOOL™ TRANSFER TANKS AND CHESTS

The JOBBOX Professional Steel Fuel-N-Tool system offers the convenience of combining liquid transfer tanks with tool chests, for secure storage space in one unit. Choose 60" chest with 6.7 cubic feet of storage space and 98 gallon tank, or 48" chest with 7.3 cubic feet of storage space and 37 gallon tank. Both Fuel-N-Tool combination options fit all full-size short wheelbase trucks.



430000 Chest & 486000 Tank

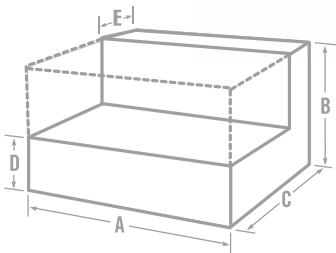
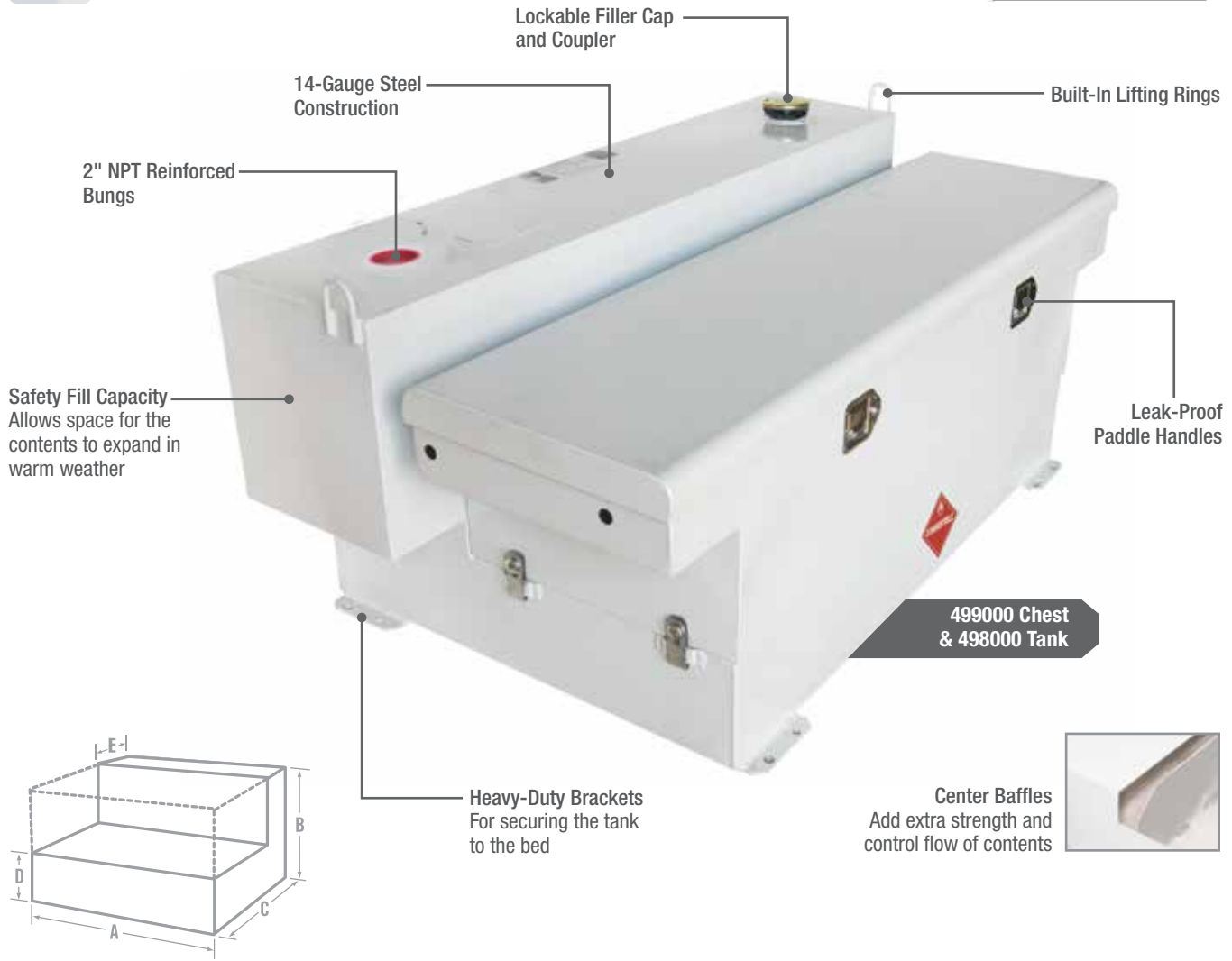

! The Safety Capacity is the MINIMUM capacity of the tank when filled to the bottom of the Bung Fill tube, not the maximum capacity of the tank.

Catalog No.	Used On	Safe Fill	Max Fill	A	B	C	D	E	Approx. Shipping Wt.
Steel Chests									
430000	486000	-	-	48-7/8 in	22-1/4 in	10-3/4 in	16-1/8 in	10-3/4 in	70 lb
499000	498000	-	-	60-1/4 in	17-5/8 in	19-5/8 in	13-7/8 in	19-5/8 in	85 lb
Steel Transfer Tanks									
486000	-	37 gal (US)	42 gal (US)	59-5/8 in	19 in	9 in	-	-	97 lb
Steel Transfer Tanks For 4-Door Trucks									
498000	-	98 gal (US)	106 gal (US)	60-1/4 in	25 in	33 in	7-1/2 in	13 in	175 lb



PRO II™ INDUSTRIAL-GRADE LADDER RACKS

PRO II Ladder Racks are made for superior load-carrying capacity and long-term durability with swaged joints and large gussets on the cross bars. They are extra-long, providing control for heavy loads and have a 1,700 lb. capacity. They also provide better protection for the cab roof and windshield.



- Made of High Tensile-Strength 2" Diameter Steel Tubing
- Removable Fourth Cross Bar Keeps Heavier Loads from Sagging
- Rear Cross Bar is Removable for Loading Taller or Bulky Cargo
- Smooth, Round Components Reduce Wind Noise and Resistance
- Yellow Zinc Dichromate Undercoat and Marine-Grade Powder Coat Epoxy Finish
- Four Standard Mounting Plates
- A complete PRO II Ladder Rack requires ordering a Side Channel Kit and a Leg & Cross Bar Kit, see below for fitment guide

Truck Type (Without Camper or Utility Shell)	Truck Model	Year	Side Channel Kit Cat. No.	Leg & Cross Bar Kit Cat. No.
Fullsize Stand. Cab Trucks - Long or Short Bed Racks	All Ford F Series, Silverado, Ram, Sierra & Tundra	All	S04000	L01000
Fullsize Extended Cab - Long Bed Racks	Silverado, Ram, Sierra, Tundra, F250 & F350	All	S06000	L01000
Fullsize Crew Cab - Long Bed Racks	F250 & F350	1999 & Up	S06000	L01040
Fullsize Crew Cab - Long Bed Racks	Silverado, Sierra & Ram	All	S06000	L01000
Fullsize Extended Cab - Short Bed Racks	F150, Silverado, Sierra, Ram, Tundra, F250 & F350	All	S06010	L01000
Fullsize Crew Cab - Short Bed Racks	F250 & F350	1999 & Up	S06010	L01040
Fullsize Crew Cab - Short Bed Racks	Silverado, Sierra & Ram	All	S06010	L01000

*Note: Short Bed Applications Simply Require Cutting To Shorten Upper Side Channels

** Note: 2002 & Up Ram Requires Cutting Of S06010 Upper Side Channels. Does Not Effect Strength



PRO III STEEL ADJUSTABLE LADDER RACKS

The 1,000 lb. capacity PRO III Ladder Racks have legs that are easily positioned to fit trucks with short or long beds, and with standard, extended, or four-door crew cabs. No cutting required. The height of these racks can be easily raised to fit trucks with taller cabs.



- Rugged 14" Long Mounting Plates Distribute Load Over a Large Area
- Removable Rear Cross Bar for Improved Access to the Bed
- Rear Grab Handles Improve Loading and Unloading Safety
- Optional No Drill Clamp-On Mounting Plates
- Fourth Cross Bar Available for Support of Long Cargo on L80000
- Yellow Zinc Dichromate Undercoat and Marine-Grade Powder Coat Epoxy Finish

Catalog No.	Size	Approx. Shipping Wt.
L80000	155 in Long Ladder Rack Fits ALL Fullsize Trucks	150.0 lb
L80020	142 in Long Ladder Rack Fits ALL Mid-Size and Compact Trucks	140.0 lb

PRO IV ALUMINUM ADJUSTABLE LADDER RACKS



Swaged joints and fully gusseted crossbars for superior load capacity make the PRO IV Aluminum Ladder Rack a perfect choice. The rack has triple-plated fasteners with chrome plating over double nickel plating.

- Rugged 14" Long Mounting Plates Distribute Load Over a Large Area
- Removable Rear Cross Bar for Improved Access to the Bed
- Rear Grab Handles Improve Loading and Unloading Safety
- Optional No drill Clamp-On Mounting Plates
- Fourth Cross Bar Available for Support of Long Cargo on L80000
- Yellow Zinc Dichromate Undercoat and Marine-Grade Powder Coat Epoxy Finish



Catalog No.	Size	Approx. Shipping Wt.
L90000	Aluminum Fully-Adjustable Ladder Rack Fits ALL Fullsize Trucks	95.0 lb

QUICK PAC REMOVABLE LADDER RACKS



Quick Pac Racks are easy to insert in the mounting bases when needed, and easily lifted out of the bases until needed again. The side-mounted racks support 250 lb. and are ideal for occasional use or when a full-length or heavier-duty rack is not required.

- Easy-to-Install Removable Racks for Carrying a Ladder, Lumber or Other Long Material
- Support Arms Adjust From 18" to 32" in Width
- Yellow Zinc Dichromate Undercoat and Marine-Grade Powder Coat Epoxy Finish
- High-Strength Mounting Bases fit in any truck and can be used on either side
- 1-1/4" Square Steel Uprights have fully welded joints



Catalog No.	Size	Approx. Shipping Wt.
L30090	Removable Side Ladder Racks	60.0 lb

FREE-STANDING ECONO LADDER RACKS



Econo Racks can be used as a pair for extra support, or free-standing to provide easy side access to bulky cargo. Long mounting plates provide stability without horizontal connecting bars. Can be paired with Window Guard A31090 to create Free-Standing Fullsize Cab Guard.

- High-Strength 2" Diameter Steel Racks Support up to 500 lb.
- Cross Bar Height can be set at 23-1/2" or 26-1/4" above the bed
- Rack width adjusts from 53" to 68"
- 14" Long Heavy-Duty Bolt-On Mounting Plates
- Yellow Zinc Dichromate Undercoat and marine-Grade Powder Coat Epoxy Finish



Catalog No.	Description	Width	Height	Approx. Shipping Wt.
L30050	Front-Mounted Econo Rack	53 in - 68 in	23-1/2 in - 26-1/4 in	35 lb



LADDER RACK ACCESSORIES

FULLSIZE TRUCK WINDOW GUARD

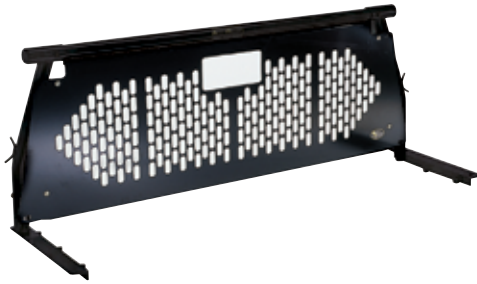

- Bolts On Existing Rack (rack and mounting plates not Included)

Catalog No.	Approx. Shipping Wt.
A31080D	22 lb

“NO DRILL” CLAMP-ON MOUNTING KIT



- For PRO II, PRO III, and Econo Rack Model L30040

Catalog No.	Approx. Shipping Wt.
A31580	4.0 lb

EXTRA CROSS BAR



- Bolts on Side Channels
- For PRO III Model L80000

Catalog No.	Approx. Shipping Wt.
A31600	12.0 lb

HOW TO MEASURE YOUR TRUCK

The following instructions generally work well when measuring a full-size truck. Mid-size and Compact trucks have a variety of truck bed configurations which increase the difficulty in measuring the truck and comparing it to the dimensions of a specific truck box. In nearly all instances, the Fitment Guide (pages 36 and 58) will provide accurate information unless the truck is a new model introduced after August, 2015.

THE TRUCK BED NEEDS TO BE MEASURED FOR TWO REASONS:

- A. To Determine that the Truck Box will be long enough to be properly mounted on the truck bed rails.
- B. To Determine whether or not the truck wheel wells will interfere and prevent proper mounting of the truck box.

A: Determining that the truck box is long enough to be properly mounted:

Measurement 1: Width between the top of the bed sidewalls. Dimension "A" of the crossover Truckbox needs to be at least 3" greater.

B. Determining whether or not the truck box will clear the wheel wells in the truck.

Need to find POINT "X" in the truck bed:

Preparing to take Measurements 2 & 3 to find a point "X" in the truck bed to ensure that the truck box will fit your truck:

- The depth of the truck box may restrict its fit in the truck because the wheel well might be in the way.
- Except for "Extra-Wide" truck boxes, most truck boxes will require 20-1/4" of horizontal space from the cab bed rail to the point where the Truck Box might hit the wheel well or the truck bed liner.

Measurement 2: A "Standard" Truck box will usually have a 9" Vertical depth below the top of the truck bed rail. A "Deep" model will usually be 12" below the top of the bed rail.

- Determine how deep a truck box you need and measure down from the top of the rail and create an imaginary, HORIZONTAL line at the depth of the truck box you need...usually 9" or 12" below the top of the truck bed rail. This is called Dimension "C" on the truck box.

Measurement 3: Find Point "X" which is on the horizontal "Imaginary Line" below the truck rail (from #2 above). On the horizontal "Imaginary Line" measure to find a point 20-1/4" away from the front truck bed rail (This measurement is from the Cab Truck Bed Rail Towards the Tailgate). The 20 1/4" is roughly Dimension "E" on the truck box and represents how much space the truck box will take in the bed behind the truck cab. After finding Point "X" in your Truck Bed....will the truck box fit?: Again, Point "X" is 20-1/4" away from the front truck cab rail on the Imaginary Horizontal Line (from measurement 2) If point "X" does not hit the wheel well, the truck box will fit. If point "X" hits the Wheel Well, you must make another measurement:

- Mark Point "X" on both wheel wells or the wheel well bed liner
- Measure the distance between the two point "X"s on the truck bed. This dimension must be greater than Dimension "B" on the Truckbox
- If Dimension "B" on the truck box is GREATER than the distance between both point "X"s, the truck box will hit the wheel well or bed liner and you will usually need to select another truck box or mount the truck box with a spacer above the bed rail.

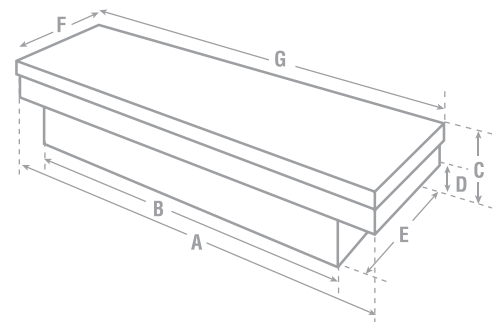
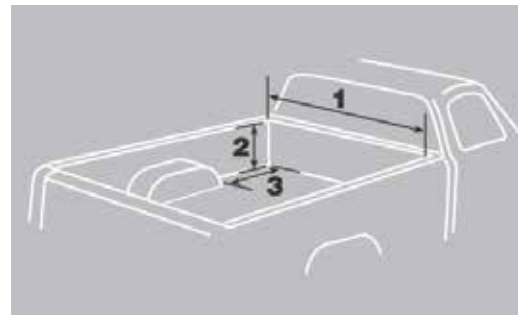

PRODUCT WARRANTY INFORMATION

JOBEX Products Limited Warranties

This product warranty is made by Apex Tool Group, LLC (ATG) to only the original purchaser and it is valid as indicated in the table below from date of purchase, upon presentation of the original sales receipt at the time the warranty claim is made. ATG warrants its product to be free from defects in materials and workmanship at the time of the sale. This warranty does not cover damage caused by accident or unreasonable or unintended use of the product. Modification, disassembly and/or reassembly of the product will invalidate this warranty. Damage to the contents of the box, vehicle or other consequential damages of whatever kind are hereby excluded from this warranty. Use only parts or accessories supplied by Apex Tool Group, LLC. Parts or accessories from other manufacturers or suppliers could alter the function and safety of the product(s) and void this warranty.

Crossovers, Innersides, Chests, Topsides and Underbed Truck Boxes.....	5 Years
On-Site Storage Products.....	1 Year
Liquid Transfer Tanks.....	1 Year
Safety Cabinets.....	5 Years
Safety Cans.....	5 Years

JOBEX cannot offer specific recommendations on chemical compatibility. Your chemical supplier, MSDS sheets, or other expert sources should be consulted. JOBEX makes no guarantee of results and assumes no obligation or liability in connection with the use of these products and their application relative to their chemical compatibility. It is the end user's sole responsibility to determine the nature of the materials to be contained and to select the proper product suitable for a particular application.

Furthermore, it is the end user's responsibility to insure that the product selected is suitable for its intended use. JOBEX makes no warranty, expressed or implied of merchantability or fitness for purpose, and assumes no liability in connection with any product made or sold by JOBEX with regard to its use of chemical compatibility.

KargoMaster Ladder Rack Lifetime Frame Warranty

KargoMaster, Inc. extends to the original purchaser of a KargoMaster product a Lifetime Frame Warranty. If the rack cracks, bends, buckles, or structurally fails in any way, KargoMaster, at its option and expense, will replace or repair the rack. For details, see the Installation Instruction Booklet included with the rack or contact Customer Service.

To Obtain Warranty Service:

In the case of a nonconforming product, you should return the product to the place where it was purchased. The seller will consult with ATG and then either repair or replace the product, at ATG's sole option, if it is determined that the product is defective in either material or workmanship. Please have the following information available to request keys, gas springs or replacement parts:

- The Key Code stamped on your key or the outside cover of the lock cylinder
- The Model Number on the label on the barrel of the gas spring
- For other replacement parts, the Model Number of your product

To obtain parts, call our Customer Service Department at the number below between 8:00 AM and 5:00 PM Eastern Standard Time Monday through Friday. Press 1 when prompted. To send an e-mail, use the address below.

1-800-643-0084

8:00 am - 4:30 pm EST

customer.service@apextoolgroup.com

JOBBOX

PREMIUM STORAGE SOLUTIONS

The products in this Catalog may be covered by one or more of the following US Patents: 5,586,702 – 5,601,206 – 5,875,948 – 6,209,739 – 6,254,208 – 6,464,095 – 6,681,604 – 6,803,167 – 6,959,846 – 7,370,890, D369,342 & D355,766 or, by Patent Applications that are pending.

The Trademarks included in this catalog are registered by or have been applied for by Apex Tool Group, LLC except KargoMaster Ladder Racks which is the property of that company.

Distributed by:

www.jobox.com

©2016 Apex Tool Group, LLC
14600 York Road, Suite A
Sparks, MD 21152
www.apextoolgroup.com

Customer Service:
Phone: 800.643.0084
Fax: 877.356.4081
customer.service@apextoolgroup.com

Printed in U.S.A.
1/2017
ATG-2950
No. T550963