

Obtaining a permit for your Best Barns or Sentry Buildings kit.

Building code offices and HOA's may require different documents to obtain a permit. The homeowners first step is to contact their local code office and ask what is needed for the size of building to be purchased.

Typically, the necessary documentation may include some or all of the following.

- Elevations showing at least two sides of structure.
- Site plan showing existing structures and proposed build site.
- Engineered drawings for truss system indicating snow and wind load ratings.*
- Cross sections of wall framing and foundation.
- Tie down locations for high wind load areas.

Permit requirements vary based on location. Some areas may not require a permit at all. The documents provided by Best Barns or Sentry Buildings are intended to help the homeowner with the permit process but do not guarantee a permit will be issued.** It is the homeowner's responsibility to determine if a permit is required and submit the necessary documentation if so.

* Engineered truss drawings stamped for your individual state can be obtained upon request. A deposit will be required if shed or garage kit has not yet been purchased. Contact us directly at 800-245-1577 for further details.

** Certain states such as Florida and California have stringent requirements for obtaining a permit. Depending on your location, a civil engineer's services may be required to provide necessary documents. These services are the homeowners responsibility to obtain and are not included in the purchase of a shed or garage kit.



Before you order our kit or begin construction, obtain a building permit. If additional documents are required contact questions@barnkits.com.

Greenbriar Elevations

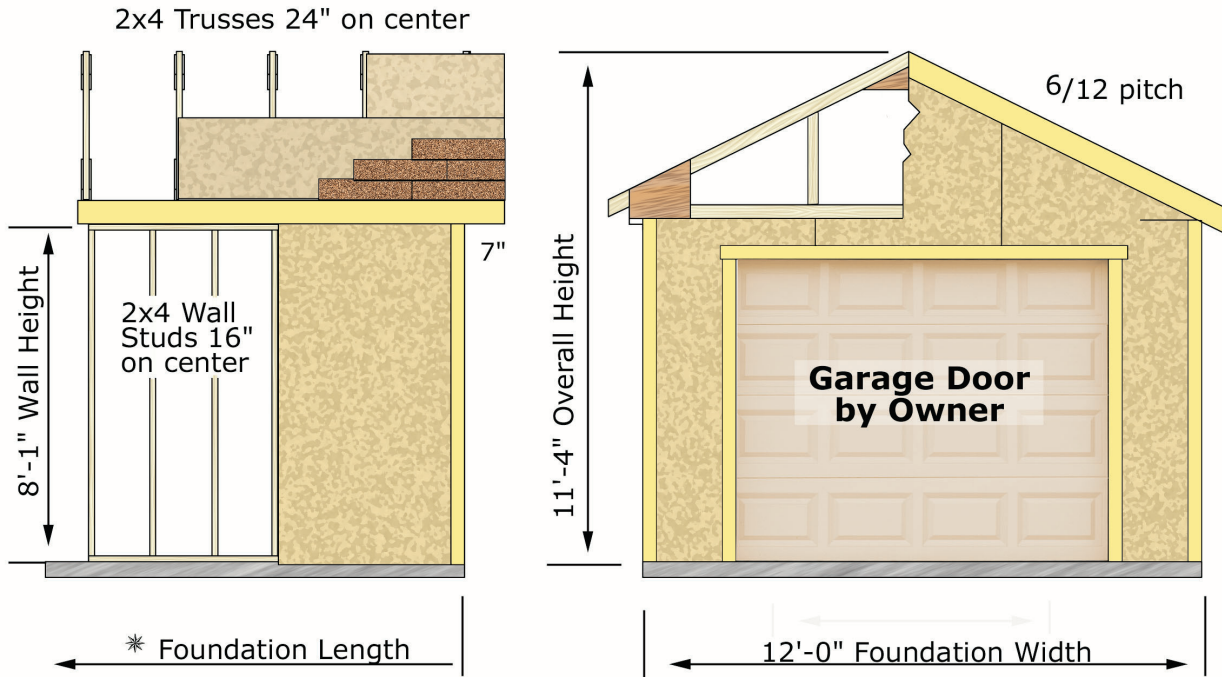

Foundation: Sold optionally

Wall Framing: 2x4 Construction with 24" on center stud spacing, single bottom plate and top plate with 2x4 tie plates.

Siding: 7/16" OSB (Oriented Strand Board) underlay. Exterior siding like Vinyl, ship lap, stucco, etc by owner.

Roof System: 2x4 trusses spaced 24" on center, (see engineered truss drawing for load ratings). 7/16" OSB roof sheathing. *Shingles by owner.*

Exterior Trim: White pine trim for corners, door, gable trim and front and back fascia. Primed ready to paint.

Garage Door: By owner.

Hardware: Nails for framing, metal hurricane hangers for trusses.

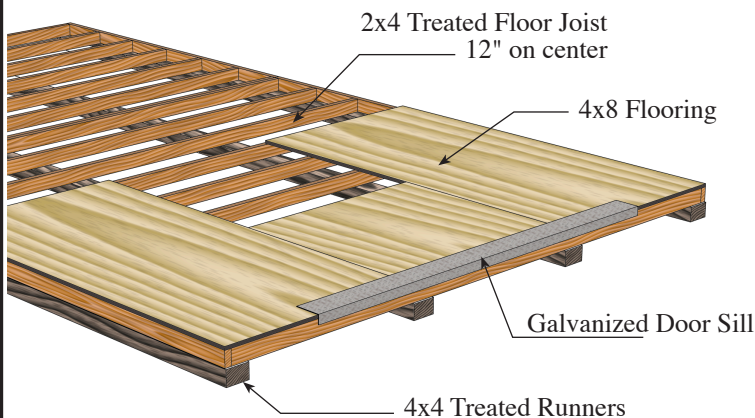

Optional Sturdy-built Floor System:

2x4 treated floor joist spaced 12" on center covered with 3/4" plywood, *not treated*, installed over 4x4 treated runners. Galvanized door sill and nails are included. Material is not pre-cut.

* 12'x16' Foundation Size	12'-0" x 16'-0"
12'x20' Foundation Size	12'-0" x 20'-0"
12'x24' Foundation Size	12'-0" x 24'-0"

Job	Truss	Truss Type	Qty	Ply	
PER16912	T1	KINGPOST	1	1	

Job Reference (optional)

7.630 s Jul 9 2015 MiTek Industries, Inc. Wed Jun 29 16:16:00 2016 Page 1
 ID:L58nGTzwTmsRVEQ6hMpDeXz1NJ6-VKhNHkoCnli?TGeDuyOAhGFLWHRMpmItVEkXFmz1N7j

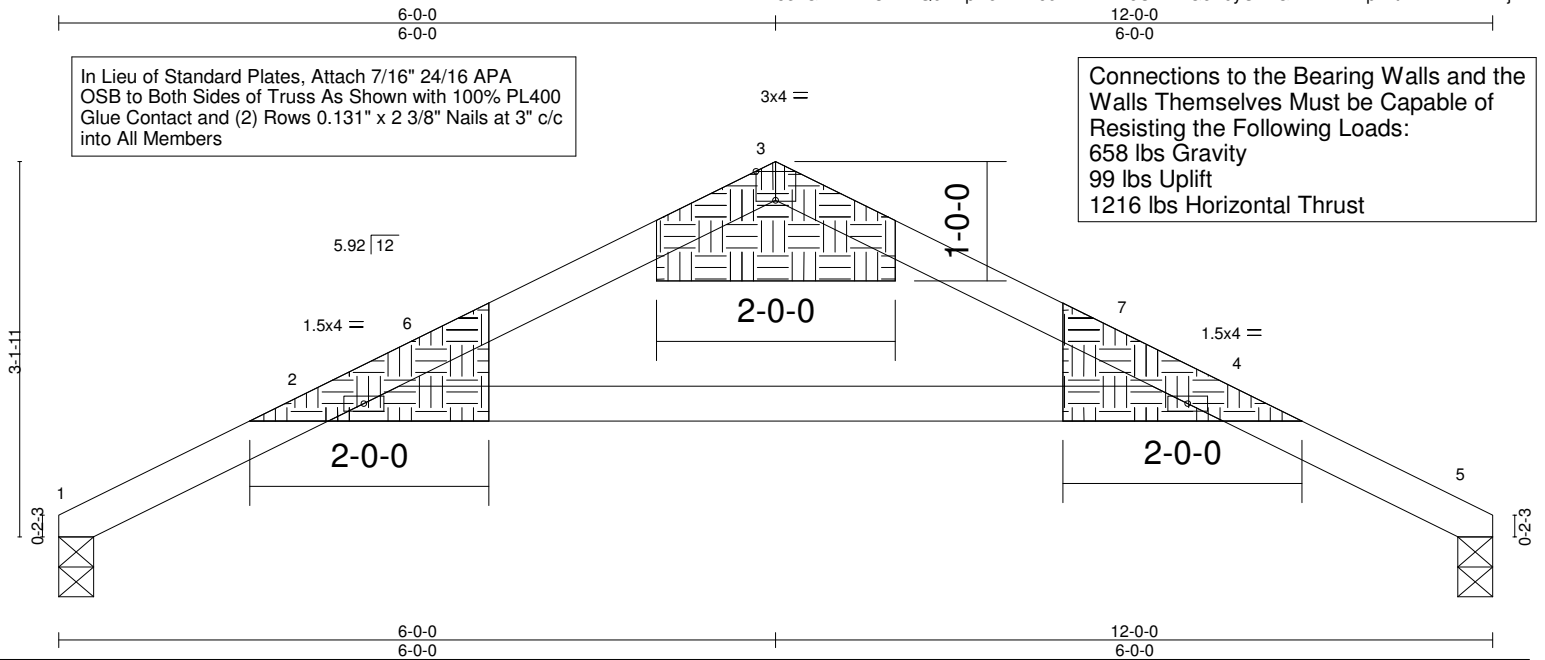

Plate Offsets (X,Y)-- [3:0-2-0,Edge]

LOADING (psf)	SPACING-	CSI.	DEFL.	in (loc)	l/defl	L/d	PLATES	GRIP
TCLL 46.2	2-0-0	TC 0.56	Vert(LL)	-0.18	2-3	>776	MT20	197/144
(Ground Snow=60.0)	Plate Grip DOL 1.15	BC 0.00	Vert(CT)	-0.19	2-3	>734		
TCDL 10.0	Lumber DOL 1.15	WB 0.79	Horz(CT)	0.00	n/a	n/a		
BCLL 0.0 *	Rep Stress Incr YES	(Matrix)					Weight: 24 lb	FT = 20%
BCDL 10.0	Code IRC2015/TPI2014							

LUMBER-
 TOP CHORD 2x4 SPF No.2
 WEBS 2x4 SPF No.2

BRACING-
 TOP CHORD
 BOT CHORD

Structural wood sheathing directly applied or 4-8-13 oc purlins.
 Rigid ceiling directly applied or 10-0-0 oc bracing.

MiTek recommends that Stabilizers and required cross bracing be installed during truss erection, in accordance with Stabilizer Installation guide.

REACTIONS. (lb/size) 1=658/0-3-8 (min. 0-1-8), 5=658/0-3-8 (min. 0-1-8)
 Max Horz 1=1223(LC 1), 5=-1223(LC 1)
 Max Uplift 1=-99(LC 10), 5=-99(LC 10)

FORCES. (lb) - Maximum Compression/Maximum Tension
 TOP CHORD 1-2=-1377/213, 2-6=-512/54, 3-6=-403/67, 3-7=-403/67, 4-7=-512/54, 4-5=-1377/213
 WEBS 2-4=-862/183

- NOTES-**
- 1) Wind: ASCE 7-10; Vult=130mph (3-second gust) Vasd=103mph; TCDL=6.0psf; BCDL=6.0psf; h=25ft; B=45ft; L=24ft; eave=4ft; Cat. II; Exp B; enclosed; MWFRS (directional); Lumber DOL=1.60 plate grip DOL=1.60
 - 2) TCLL: ASCE 7-10; Pg= 60.0 psf (ground snow); Pf=46.2 psf (flat roof snow); Category II; Exp B; Partially Exp.; Ct=1.1
 - 3) Unbalanced snow loads have been considered for this design.
 - 4) * This truss has been designed for a live load of 20.0psf on the bottom chord in all areas where a rectangle 3-6-0 tall by 2-0-0 wide will fit between the bottom chord and any other members.
 - 5) Bearing at joint(s) 1, 5 considers parallel to grain value using ANSI/TPI 1 angle to grain formula. Building designer should verify capacity of bearing surface.
 - 6) Provide mechanical connection (by others) of truss to bearing plate capable of withstanding 99 lb uplift at joint 1 and 99 lb uplift at joint 5.
 - 7) Non Standard bearing condition. Review required.
 - 8) This truss is designed in accordance with the 2015 International Residential Code sections R502.11.1 and R802.10.2 and referenced standard ANSI/TPI 1.
 - 9) "Pin all pitchbreaks" Member end fixity model was used in the analysis and design of this truss.

LOAD CASE(S) Standard

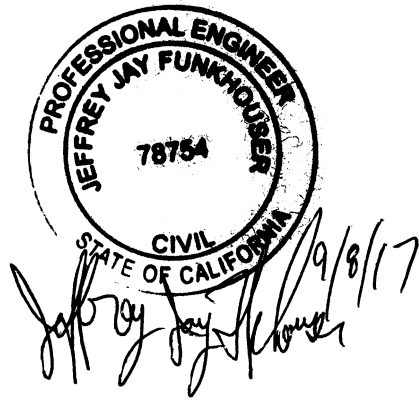

Best Barns model: _____
 ___ ft. wide x ___ ft. long

Manufactured by:
 Reynolds Building Systems, Inc.
 205 Arlington Drive
 Greenville, PA 16125
 phone: 800-245-1577
 fax: 724-646-0772

Common Foundation Cross Sections

This document illustrates common foundation types which can be used for construction of Best Barns 12 ft. wide structures. Alteration may be necessary to conform to homeowners intended use and or permitting requirements.

Drawings not to scale.

Instructions:

Check appropriate foundation cross section and provide specifications as necessary.

Homeowner may also design and draw in space provided for custom foundation type.

Concrete Slab

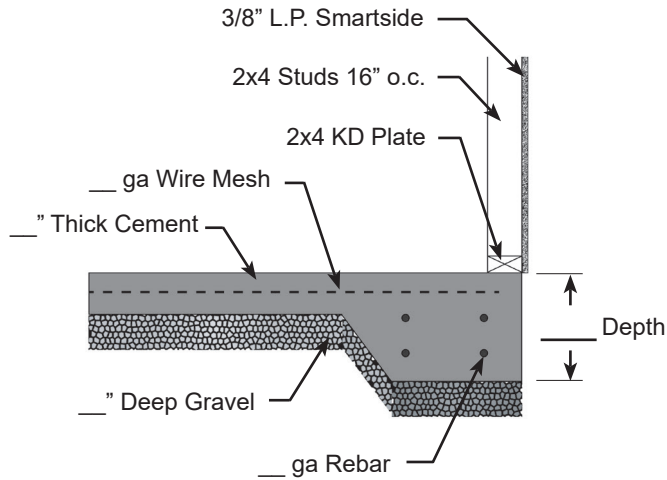

Wood Floor

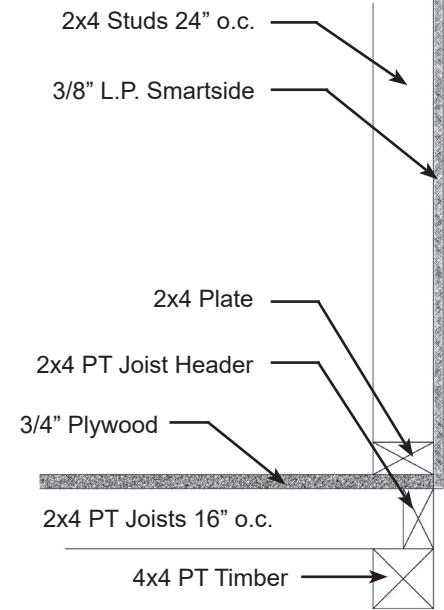

Homeowner Design

Best Barns model: _____
____ ft. wide x ____ ft. long

Manufactured by:
Reynolds Building Systems, Inc.
205 Arlington Drive
Greenville, PA 16125
phone: 800-245-1577
fax: 724-646-0772

Truss & Wall Cross Section

Top of wall inclusive of wall
framing and truss cross sections.

Drawing not to scale.

Instructions:

Homeowner may provide
additional information as
appropriate.

Notes:

Refer to installation manual for
further detail.

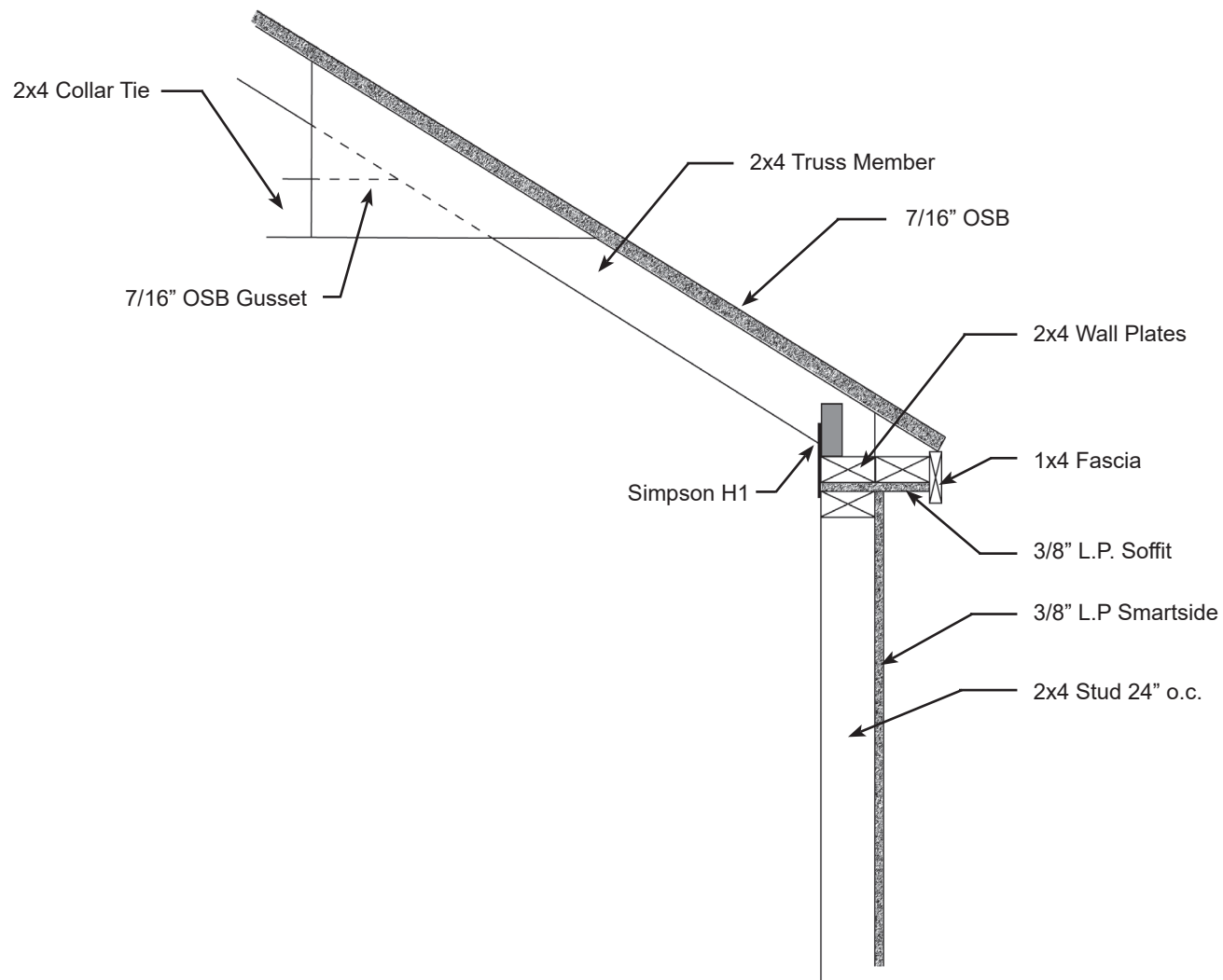

Site Plan for:

Manufactured by:
Reynolds Building Systems, Inc.
205 Arlington Drive
Greenville, PA 16125
phone: 800-245-1577
fax: 724-646-0772

Instructions:

Draw property line, existing structures and proposed placement of building.

Homeowner may also be required to show trees and shrubs. Check with HOA or permit office for requirements.

A large, empty rectangular box with a black border, intended for the site plan drawing. It occupies the right two-thirds of the page.