

# Built-In Electric Wall Oven

---

## User manual

NV51K6650D\*

---



**SAMSUNG**

## Regulatory Notice

---

### 1. FCC Notice

#### CAUTION

**FCC CAUTION:** Any changes or modifications not expressly approved by the party responsible for compliance could void the user's authority to operate the equipment.

This device complies with Part 15 of FCC Rules. Operation is Subject to following two conditions:

- 1) This device may not cause harmful interference, and
- 2) This device must accept any interference received including interference that cause undesired operation.

For products sold in the US and Canadian markets, only channels 1~11 are available. You cannot select any other channels.

### FCC STATEMENT:

This equipment has been tested and found to comply within the limits for a Class B digital device, pursuant to part 15 of the FCC Rules. These limits are designed to provide reasonable protection against harmful interference in a residential installation.

This equipment generates, uses, and can radiate radio frequency energy and, if not installed and used in accordance with the instructions, may cause harmful interference to radio communications. However, there is no guarantee that interference will not occur in a particular installation. If this equipment does cause harmful interference to radio or television reception, which can be determined by turning the equipment off and on, the user is encouraged to try to correct the interference by one or more of the following measures:

- Reorienting or relocating the receiving antenna
- Increasing the separation between the equipment and receiver
- Connecting the equipment to an outlet that is on a different circuit than the radio or TV
- Consulting the dealer or an experienced radio/TV technician for help.

---

### **FCC RADIATION EXPOSURE STATEMENT:**

This equipment complies with FCC radiation exposure limits set forth for an uncontrolled environment. This equipment should be installed and operated so there is at least 8 inches (20 cm) between the radiator and your body. This device and its antenna(s) must not be co-located or operated in conjunction with any other antenna or transmitter.

### **2. IC Notice**

The term "IC" before the radio certification number only signifies that Industry Canada technical specifications were met. Operation is subject to the following two conditions: (1) this device may not cause interference, and (2) this device must accept any interference, including interference that may cause undesired operation of the device.

This Class B digital apparatus complies with Canadian ICES-003. For products sold in the US and Canadian markets, only channels 1~11 are available. You cannot select any other channels.

---

### **IC RADIATION EXPOSURE STATEMENT:**

This equipment complies with IC RSS-102 radiation exposure limits set forth for an uncontrolled environment. This equipment should be installed and operated so there is at least 8 inches (20 cm) between the radiator and your body. This device and its antenna(s) must not be co-located or operated in conjunction with any other antenna or transmitter.

# Contents

<b>Important safety instructions</b>	<b>5</b>		
<b>Introducing your new oven</b>	<b>17</b>		
Overview	17		
What's included with your oven	17		
<b>Before you begin</b>	<b>17</b>		
Energy saving tips	17		
Water reservoir	17		
<b>Operating the oven</b>	<b>19</b>		
The oven control panel	19		
Control panel display modes	20		
Setting the clock	20		
Setting the kitchen timer	20		
Control Lockout	21		
Timed Cooking	21		
Delay Start	22		
Turning the light on and off	22		
Minimum and maximum settings	22		
Using the oven racks	23		
Using the Gliding Rack	24		
Baking	25		
Convection baking	26		
Convection roasting	27		
No Preheat	27		
Broiling	28		
Steam baking and roasting (upper oven only)	29		
		Using Bread Proof (lower oven only)	30
		Using Keep Warm (lower oven only)	30
		Using the Temp Probe (upper oven only)	30
		Using Smart Control	32
		Using Options	32
		Using the Sabbath feature	34
		<b>Maintaining your appliance</b>	<b>35</b>
		Self-cleaning	35
		Hybrid Cleaning	37
		Descal	39
		Draining	39
		Care and cleaning of the oven	40
		Removing the oven doors	42
		Replacing the oven door(s)	42
		Changing the oven light	43
		Troubleshooting	44
		Information codes	47
		<b>Warranty (U.S.A)</b>	<b>48</b>
		<b>Warranty (CANADA)</b>	<b>49</b>
		Open Source Announcement	51

## Important safety instructions

Read and follow all instructions before using your oven to prevent the risk of fire, electric shock, personal injury, or damage when using the oven. This guide does not cover all possible conditions that may occur. Always contact your service agent or the manufacturer about problems that you do not understand.

### WHAT YOU NEED TO KNOW ABOUT SAFETY INSTRUCTIONS

Warnings and important safety instructions in this manual do not cover all possible conditions and situations that may occur. It is your responsibility to use common sense, caution, and care when installing, maintaining, and operating your oven.

### Important safety symbols and precautions

What the icons and signs in this user manual mean:

#### **WARNING**

Hazards or unsafe practices that may result in **severe personal injury or death**.









#### **CAUTION**

Hazards or unsafe practices that may result in **minor personal injury or property damage**.

**SAVE THESE INSTRUCTIONS**

#### **CAUTION**

To reduce the risk of fire, explosion, electric shock, or personal injury when using your oven, follow these basic safety precautions.

-  Do NOT attempt.
-  Do NOT disassemble.
-  Do NOT touch.
-  Follow directions explicitly.
-  Unplug the power plug from the wall socket.
-  Make sure the machine is grounded to prevent electric shock.
-  Call a Samsung service center for help.
-  Note

These warning signs are here to prevent injury to you and others. Please follow them explicitly.

After reading this section, keep it in a safe place for future reference.

**SAVE THESE INSTRUCTIONS**

## Important safety instructions

### STATE OF CALIFORNIA PROPOSITION 65 WARNING (US ONLY)

WARNING : This product contains chemicals known to the State of California to cause cancer and birth defects or other reproductive harm.

### FOR YOUR SAFETY

When using electrical appliances, you should follow basic safety precautions, including the following:

#### CAUTION

- Use this appliance only for its intended purpose as described in this Owner's Manual.
- Potentially hot surfaces include the oven vent opening, surfaces near the opening, and crevices around the oven door.

 **Proper Installation** - Be sure your appliance is properly installed and grounded by a qualified technician.

 **User servicing** - Do not repair or replace any part of the appliance unless specifically recommended in this manual. All other servicing should be referred to a qualified technician.



Always disconnect the power to the appliance before servicing by removing the fuse or switching off the circuit breaker.



- **Do not enter the oven.**
- **Do not leave children alone.** Never leave children alone or unattended in an area where this appliance is in use. They should never be allowed to sit or stand on any part of the appliance.
- **Never use your appliance for warming or heating the room.**
- **Do not use water on grease fires.** Turn off the oven to avoid spreading the flames. Smother the fire or flames by closing the door or use a dry chemical, baking soda, or foam-type extinguisher.
- Avoid scratching or striking the glass doors and the control panel. Doing so may lead to glass breakage. Do not cook on a product with broken glass. Shock, fire, or cuts may occur.

**SAVE THESE INSTRUCTIONS**

**SAVE THESE INSTRUCTIONS**

- 
- ☒ • If there is a fire in the oven during self-cleaning, turn the oven off and wait for the fire to go out. Do not force the door open. The introduction of fresh air at self-cleaning temperatures may lead to a burst of flame from the oven. Failure to follow these instructions may result in severe burns.
  - If the oven is heavily soiled with oil, self-clean the oven before using the oven again. Leaving the oil in place creates a risk of fire.
  - Wipe up heavy soil on the oven bottom with a paper towel or rag before self-cleaning. Self-cleaning the oven when there is heavy soil on the oven bottom requires longer cleaning cycles and produces more smoke.
  - ★ • **Storage in or on the appliance.** Do not store flammable materials in the oven or near the surface units. Be sure all packing materials are removed from the appliance before operating it. Keep plastics, clothes, and paper away from parts of the appliance that may become hot.
  - **Wear proper apparel.** Never wear loose-fitting or hanging garments while using the appliance.

**SAVE THESE INSTRUCTIONS**

- 
- ★ • **Use only dry potholders.** Placing moist or damp potholders on hot surfaces may result in burns from steam. Do not let the potholder touch hot heating elements. Do not use a towel or other bulky cloth instead of a potholder.
  - Teach children not to play with the controls or any other part of the oven.
  - For your safety, do not use high-pressure water cleaners or steam jet cleaners to clean any part of the oven.
  - If the power cord is damaged, it must be replaced by the manufacturer, its service agent, or similarly qualified persons to avoid creating a hazard.
  - The appliance is not intended for use by persons (including children) with reduced physical, sensory or mental capabilities, or lack of experience and knowledge, unless they have been given supervision or instruction concerning use of the appliance by a person responsible for their safety.

**SAVE THESE INSTRUCTIONS**

## Important safety instructions

### ELECTRICAL SAFETY

- ★ Use only the factory installed flexible power cord to connect to the power supply. Do not use a 3rd party power supply cord kit.
- The appliance should be serviced only by qualified service personnel. Repairs carried out by unqualified individuals may cause injury or a serious malfunction. If your appliance is in need of repair, contact a Samsung authorized service center. Failure to follow these instructions may result in damage and void the warranty.
- Flush - mounted appliances may be operated only after they have been installed in cabinets and workplaces that conform to the relevant standards. This ensures that the appliances are installed in compliance with the appropriate safety standards.
- If your appliance malfunctions or if fractures, cracks, or splits appear:
  - Switch off the oven.
  - Unplug the oven from the AC wall outlet.
  - Contact your local Samsung service center.

### ⚠ WARNING

- Ensure that the appliance is switched off before replacing the lamp to avoid the possibility of electric shock.

### CHILD SAFETY

#### ⚠ WARNING

- This appliance is not intended for use by young children or infirm persons without the adequate supervision of a responsible adult.
- Young children should be supervised to ensure that they do not play with the appliance.
- Keep children away from the door when opening or closing it as they may bump themselves on the door or catch their fingers in the door.
- During self-cleaning, the surfaces may get hotter than usual. Keep small children away from the oven when it is in the self-cleaning mode.

#### ⚠ WARNING

Accessible parts may become hot during use. To avoid burns, young children should be kept away.

**SAVE THESE INSTRUCTIONS**

**SAVE THESE INSTRUCTIONS**



## OVEN

- ❑ • **DO NOT TOUCH THE HEATING ELEMENTS OR INTERIOR SURFACES OF THE OVEN.** Heating elements may be hot even though they are dark in color. Interior surfaces of an oven become hot enough to cause burns. During and after use, do not touch or let clothing or other flammable materials contact the heating elements or interior surfaces of the oven until they have had sufficient time to cool. Other surfaces of the appliance may become hot enough to cause burns. Among these surfaces are oven vent openings and surfaces near these openings, the oven door, and the window of the oven door.
- **Do not heat unopened food containers.** The build-up of pressure may cause the container to burst and result in injury.
- **Do not use the oven to dry newspapers.** If overheated, newspapers can catch fire.
- **Do not use the oven for a storage area.** Items stored in an oven can ignite.

**SAVE THESE INSTRUCTIONS**

- ★ • **Use care when opening the door.** Let hot air or steam escape before you remove food from or put food into the oven.
- **Protective liners.** Do not use aluminum foil to line the oven bottoms, except as suggested in this manual. Improper installation of these liners may result in a risk of electric shock or fire.
- **Placement of oven racks.** Always place oven racks in the desired location while the oven is cool. If the rack must be moved while the oven is hot, use potholders. Do not let the potholders come in contact with the hot heating element in the oven.
- ❑ • Do not allow aluminum foil or a meat probe to contact the heating elements.
- ❑ • **During use, the appliance becomes hot.** Care should be taken to avoid touching heating elements inside the oven.
- Do not use harsh abrasive cleaners or sharp metal scrapers to clean the oven door glass. They can scratch the surface which may result in the glass shattering.



**SAVE THESE INSTRUCTIONS**

## Important safety instructions

### CAUTION

**Do not attempt to operate the oven during a power failure.** If the power fails, always turn the oven off. If the oven is not turned off and the power returns, the oven may begin to operate again. Food left unattended could catch fire or spoil.

### SELF-CLEANING OVENS

-  **Do not clean the door gasket.** The door gasket is essential for a good seal. Care should be taken not to rub, damage, or move the gasket.
-  **Never keep pet birds in the kitchen.** Birds are extremely sensitive to the fumes released during an oven self-clean cycle. Fumes may be harmful or fatal to birds. Move birds to a well-ventilated room.
- Clean only the parts listed in this manual in the self-clean cycle.** Before self-cleaning the oven, remove the partition, rack, utensils, and any food.
- Before operating the self-clean cycle, wipe grease and food soils from the oven. Excessive amounts of grease may ignite, leading to smoke damage to your home.

**SAVE THESE INSTRUCTIONS**

-  Do not use any commercial oven cleaner or oven liner protective coating of any kind in or on the outside of the oven.
- Remove the nickel oven shelves from the oven before you begin the self-cleaning cycle or they may discolor.
- If the self-cleaning mode malfunctions, turn the oven off and disconnect the power supply. Have it serviced by a qualified technician.
- Excess spillage must be removed before you run the self-cleaning cycle.



### VENTILATING HOOD

-  **Clean ventilating hoods frequently.** Do not let grease accumulate on the hood or filter.
- When flaming foods under the hood, turn the fan on.**





**SAVE THESE INSTRUCTIONS**

## CRITICAL INSTALLATION WARNINGS

### WARNING

-  This appliance must be installed by a qualified technician or service company.
  - Failing to have a qualified technician install the oven may result in electric shock, fire, an explosion, problems with the product, or injury.
- Unpack the oven, remove all packaging material and examine the oven for any damage such as dents on the interior or exterior of the oven, broken door latches, cracks in the door, or a door that is not lined up correctly. If there is any damage, do not operate the oven and notify your dealer immediately.
- Keep all packaging materials out of the reach of children. Children may use them for play and injure themselves.
-  This appliance must be properly grounded.
  - Do not ground the appliance to a gas pipe, plastic water pipe, or telephone line.
    - This may result in electric shock, fire, an explosion, or problems with the product

**SAVE THESE INSTRUCTIONS**

-  Do not cut or remove the ground prong from the power cord under any circumstances.
- Connect the oven to a circuit that provides the correct amperage.
-  Do not install this appliance in a humid, oily or dusty location, or in a location exposed to direct sunlight or water (rain drops).
  - This may result in electric shock or fire.
- Do not use a damaged power cord or loose wall socket.
  - This may result in electric shock or fire.
- Do not pull or excessively bend the power cord.
- Do not twist or tie the power cord.
-  Do not hook the power cord over a metal object, place a heavy object on the power cord, or insert the power cord between objects.
  - This may result in electric shock or fire.
-  If the power cord is damaged, contact your nearest Samsung service center.

**SAVE THESE INSTRUCTIONS**



## Important safety instructions

### CRITICAL USAGE WARNING

#### CAUTION

-  • If the appliance is flooded by any liquid, please contact your nearest Samsung service center. Failing to do so may result in electric shock or fire.
- If the appliance produces a strange noise, a burning smell, or smoke, unplug the power plug immediately and contact your nearest Samsung service center.
  - Failing to do so may result in electric shock or fire
- In the event of a gas leak (such as propane gas, LP gas, etc.), ventilate the area immediately. Do not touch the power cord. Do not touch the appliance.
  - A spark may result in an explosion or fire.
- Take care not to contact the oven door, heating elements, or any of the other hot parts with your body while cooking or just after cooking.
  - Failing to do so may result in burns.
- If materials inside the oven should ignite, keep the oven door closed, turn the oven off and disconnect the power cord, or shut off power at the fuse or circuit breaker panel. If the door is opened, the fire may spread.

**SAVE THESE INSTRUCTIONS**

-  • Always observe safety precautions when using your oven. Never try to repair the oven on your own - there is dangerous voltage inside. If the oven needs to be repaired, contact an authorized Samsung service center near you.
- If you use the appliance when it is contaminated by foreign substances such as food waste, it may result in a problem with the appliance.
- Take care when removing the wrapping from food taken out of the appliance.
  - If the food is hot, hot steam may be emitted abruptly when you remove the wrapping and this may result in burns.
-  • Do not attempt to repair, disassemble, or modify the appliance yourself.
  - Since a high voltage current enters the product chassis, it may result in electric shock or fire.
  - When a repair is needed, contact your nearest Samsung service center.
-  • If any foreign substance such as water has entered the appliance, contact your nearest Samsung service center.
  - Failing to do so may result in electric shock or fire.

**SAVE THESE INSTRUCTIONS**

- 
- ❑ • Do not touch the power cord with wet hands.
    - This may result in electric shock.
  - Do not turn the appliance off while an operation is in progress.
    - This may cause a spark and result in electric shock or fire.
  - Do not let children or any person with reduced physical, sensory, or mental capabilities use this appliance unsupervised.
  - Make sure that the appliance's controls and cooking areas are out of the reach of children.
    - Failing to do so may result in electric shock, burns, or injury.
  - Do not touch the inside of the appliance immediately after cooking. The inside of the appliance will be hot.
    - Failing to do so may result in burns.
  - Do not use or place flammable sprays or objects near the oven.
    - Flammable items or sprays can cause fires or an explosion.

**SAVE THESE INSTRUCTIONS**

- 
- ❑ • Do not insert fingers, foreign substances, or metal objects such as pins or needles into inlets, outlets, or holes. If foreign substances are inserted into any of these holes, contact your product provider or nearest Samsung service center.
  - Do not tamper with or make any adjustments or repairs to the door. Under no circumstances should you remove the door or outer shell of the oven.
  - Do not store or use the oven outdoors.
  - Never use this appliance for purposes other than cooking.
    - Using the appliance for any purpose other than cooking may result in fire.
  - Open the cap or stopper of sealed containers (herb tonic tea bottle, baby bottle, milk bottle and so on) before heating them. Make a hole in food items that have shells (eggs, chestnuts, etc) with a knife before cooking them.
    - Failing to do so may result in burns or injury.
  - Never heat plastic or paper containers and do not use them for cooking.
    - Failing to do so may result in fire.

**SAVE THESE INSTRUCTIONS**

## Important safety instructions

- ❏ Do not heat food wrapped in paper from magazines, newspapers, etc.
  - This may result in fire.
- Do not open the door when the food in the oven is burning.
  - If you open the door, it causes an inflow of oxygen and may cause the food to ignite.
- Do not apply excessive pressure to the door or the inside of the appliance. Do not strike the door or the inside or the appliance.
  - Hanging on to the door may result in the product falling and cause serious injury.
  - If the door is damaged, do not use the appliance. Contact a Samsung service center.
- Do not hold food in your bare hands during or immediately after cooking.
  - Use cooking gloves. The food may be very hot and you could burn yourself.
  - As the handle and oven surfaces may be hot enough to cause burns after cooking, use cooking gloves to protect your hands from burns.

## USAGE CAUTIONS

### ⚠ CAUTION

- ★ If the surface is cracked, turn the appliance off.
  - Failing to do so may result in electric shock.
- Dishes and containers can become hot. Handle with care.
- Hot foods and steam can cause burns. Carefully remove container coverings, directing the steam away your hands and face.
- Remove lids from baby food jars before heating. After heating baby food, stir well to distribute the heat evenly. Always test the temperature by tasting before feeding the baby. The glass jar or the surface of the food may appear to be cooler than the interior, which can be hot enough to burn an infant's mouth.
- Take care as beverages or food may be very hot after heating.
  - Especially when feeding a child, make sure the food or beverage has cooled sufficiently.

**SAVE THESE INSTRUCTIONS**

**SAVE THESE INSTRUCTIONS**

- 
- ★ • Take care when heating liquids such as water or other beverages.
    - Make sure to stir during or after cooking.
    - Avoid using a slippery container with a narrow neck.
    - Wait at least 30 seconds after heating before removing the heated liquid.
    - Failing to do so may result in an abrupt overflow of the contents and cause burns.
  - ☐ • Do not stand on top of the appliance or place objects (such as laundry, an oven cover, lighted candles, lighted cigarettes, dishes, chemicals, metal objects, etc.) on the appliance.
    - Items, such as a cloth, may get caught in the door.
    - This may result in electric shock, fire, problems with the product, or injury.
  - Do not operate the appliance with wet hands.
    - This may result in electric shock.
  - Do not spray volatile substances such as insecticide onto the surface of the appliance.
    - As well as being harmful to humans, it may also result in electric shock, fire, or problems with the product.

**SAVE THESE INSTRUCTIONS**

- 
- ☐ • Do not put your face or body close to the appliance while cooking or when opening the door just after cooking.
    - Take care that children do not come too close to the appliance.
    - Failing to do so may result in children burning themselves.
  - Do not place food or heavy objects over the edge of the oven door.
    - If you open the door, the food or object may fall and this may result in burns or injury.
  - Do not abruptly cool the door, the inside of the appliance, or a dish by pouring water over it during or just after cooking.
    - This may result in damage to the appliance. The steam or water spray may result in burns or injury.
  - Do not operate while empty except for self-cleaning.
  - Do not defrost frozen beverages in narrow-necked bottles. The bottles can break.
  - Do not scratch the glass of the oven door with a sharp object.
    - This may result in the glass being damaged or broken.
  - Do not store anything directly on top of the appliance when it is in operation.

**SAVE THESE INSTRUCTIONS**

## Important safety instructions

- ❑ Do not use sealed containers. Remove seals and lids before cooking. Sealed containers can explode due to the build up of pressure even after the oven has been turned off.
- Take care that food you are cooking in the oven does not come into contact with the heating element.
  - This may result in fire.
- Do not over-heat food.
  - Overheating food may result in fire.
- Use caution when opening or closing the door. Your fingers may be pinched, resulting in physical injury.
- **The door reveals wires at the bottom for connecting LED lights. So use caution not to pull or cut the wires when handling the door.**

## CRITICAL CLEANING WARNINGS

### ⚠ CAUTION

- ★ Do not clean the appliance by spraying water directly on to it.
- Do not use benzene, thinner, or alcohol to clean the appliance.
  - This may result in discoloration, deformation, damage, electric shock, or fire.
- ★ Take care not to hurt yourself when cleaning the appliance (externally or internally).
  - You may hurt yourself on the sharp edges of the appliance.
- Do not clean the appliance with a steam cleaner.
  - This may result in corrosion.
- Keep the inside of the oven clean. Food particles or spattered oils stuck to the oven walls or floor can cause paint damage and reduce the efficiency of the oven.

**SAVE THESE INSTRUCTIONS**

**SAVE THESE INSTRUCTIONS**



# Introducing your new oven

## Overview

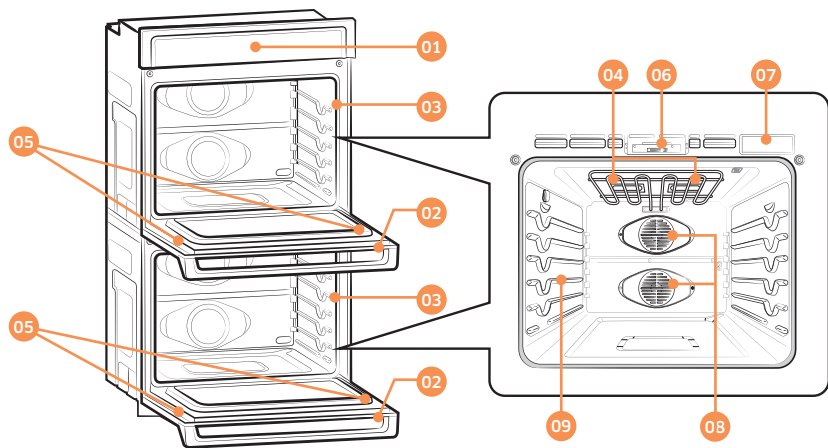

- |                       |                   |                   |
|-----------------------|-------------------|-------------------|
| 01 Oven control panel | 02 Oven door      | 03 Oven gasket    |
| 04 Halogen lamp *     | 05 Door LED light | 06 Door latch     |
| 07 Water Reservoir    | 08 Convection fan | 09 Shelf position |

## What's included with your oven

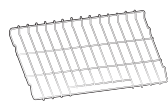

Wire racks (4)\*

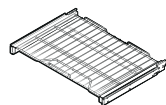

Gliding rack (1)\*

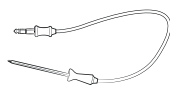

Temp Probe (1)\*

### NOTE

If you need an accessory marked with a \*, you can buy it from the Samsung Contact Center (1-800-726-7864).

# Before you begin

Clean the oven thoroughly before using it for the first time. Then, remove the accessories, set the oven to Bake, and then run the oven at 400 °F for 1 hour. There will be a distinctive odor. This is normal. Ensure your kitchen is well ventilated during this conditioning period.

## Energy saving tips

- During cooking, the oven door should remain closed except when you turn food over. Do not open the door frequently during cooking to maintain the oven temperature and to save energy.
- If cooking time is more than 30 minutes, you can switch the oven off 5-10 minutes before the end of the cooking time to save energy. The residual heat will complete the cooking process.
- To save energy and reduce the time needed for re-heating the oven, plan oven use to avoid turning the oven off between cooking one item and the next.
- Whenever possible, cook more than one item at a time.

## Water reservoir

The water reservoir is used for the Steam Bake, Steam Roast, and Hybrid Clean functions and also to remove water scale that may form on the oven walls, especially after Steam Baking, Steam Roasting, and Hybrid cleaning. Fill it with water in advance of Steam cooking or descaling.

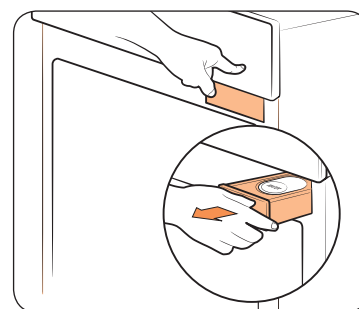

1. Locate the water reservoir. The water reservoir is on the right side of the oven, just above the oven opening. Touch **Reservoir** on the control panel to open the water reservoir. Grasp the reservoir and slide it out to remove it.

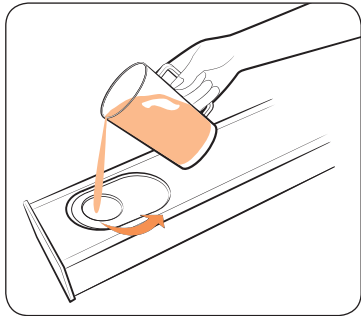

2. Open the reservoir cap, and then fill the reservoir with **22 oz (650ml)** of drinkable water.

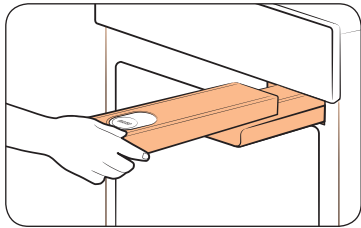

3. Close the cap, and then slide the water reservoir back into the reservoir slot.
4. Touch **Reservoir** , and then push the reservoir all the way back to reinsert the reservoir fully.

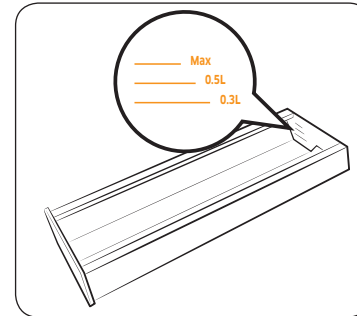

 **NOTE**

Do not exceed the max line.

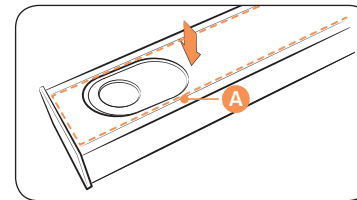

 **NOTE**

Make sure the cap and the upper portion of the water reservoir (**labeled A**) are closed before using the oven.

 **CAUTION**

The water reservoir becomes hot during the cooking. Make sure you wear oven gloves to remove or refill the water reservoir.

 **NOTE**

- If **Reservoir**  on the control panel is blinking, the water reservoir is not closed properly. Close the reservoir completely.
- If 'Hot' appears on the display, be careful. The oven and the water reservoir are hot.

# Operating the oven

## The oven control panel

**READ THE INSTRUCTIONS CAREFULLY BEFORE USING THE OVEN.** For satisfactory use of your oven, become familiar with the various features and functions of the oven as described below. **Detailed instructions for each feature and function follow later in this user manual.**

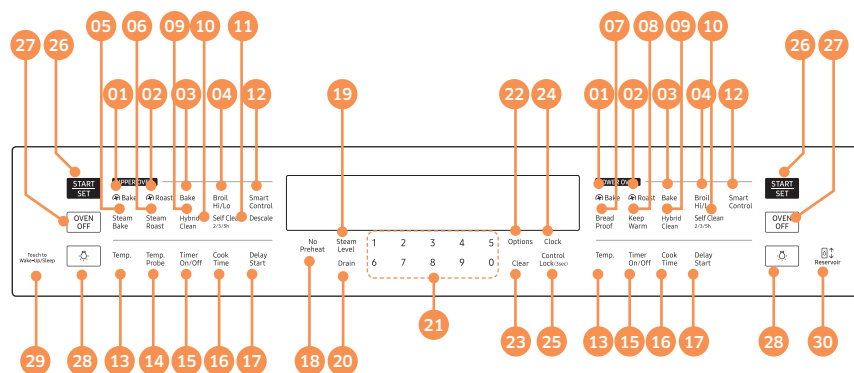

- 01** **Bake (Convection Bake):** Use to select the Convection Bake function. (Additionally, use to activate the No Preheat function in this mode.)
- 02** **Roast (Convection Roast):** Use to select the Convection Roast function. (Additionally, use to activate the No Preheat function in this mode.)
- 03** **Bake:** Use to select the Bake function.
- 04** **Broil Hi/Lo:** Use to select the Broil function.
- 05** **Steam Bake:** Use to select the Steam Bake function.
- 06** **Steam Roast:** Use to select the Steam Roast function.
- 07** **Bread Proof:** Use to select the Bread Proof function.
- 08** **Keep Warm:** Use to select the Keep Warm function to keep cooked foods warm.
- 09** **Hybrid Clean:** Use to select the Hybrid Clean function.
- 10** **Self Clean 2/3/5h:** Use to select the Self-cleaning function. While Self-cleaning is running in one oven, you cannot use the other oven for any function.
- 11** **Descal:** Use to select the Descal function.

- 12** **Smart Control:** Use to select the Smart Control feature.
- 13** **Temp.:** Use to change the temperature when the oven is operating.
- 14** **Temp. Probe:** Use to activate the Temp Probe mode.
- 15** **Timer On/Off:** Use to set or cancel the kitchen timer. The kitchen timer does not start or stop cooking.
- 16** **Cook Time:** Touch and then use the number pad to set the amount of time you want your food to cook. The oven will shut off when the cooking time has run out.
- 17** **Delay Start:** Use to set the oven to start and stop automatically at a time you set.
- 18** **No Preheat:** Use to activate the No Preheat function in the Convection Bake and Convection Roast modes.
- 19** **Steam Level:** Use to select a steam level (Lo, Mid, Hi).
- 20** **Drain:** Use to select the drain function.
- 21** **Number pad:** Use to set any function requiring numbers such as the time of day on the clock, the timer, the oven temperature, the start time, and the length of operation for timed baking, etc.
- 22** **Options:** Use to bring up the User Preference menu in the display.
- 23** **Clear:** Use to cancel a previously entered temperature or time.
- 24** **Clock:** Use to set the time of day.
- 25** **Control Lock(3sec):** Use to disable all oven functions.
- 26** **START/SET:** Use to start any cooking or cleaning function in the oven.
- 27** **OVEN OFF:** Use to cancel all oven operations except the clock and timer.
- 28** **Lamp** : Use to turn the light (Oven and Door) on or off.
- 29** **Touch to Wake-Up/Sleep:** Use to activate or deactivate buttons and functions on the display.
- 30** **Reservoir** : Use to open the water reservoir for Steam Bake, Steam Roast and Hybrid Clean cleaning.



# Operating the oven

## Control panel display modes

### Sleep Mode

Your control panel will remain in a sleep mode when not in use. Only the clock will display. You will need to wake the control panel to begin any function.

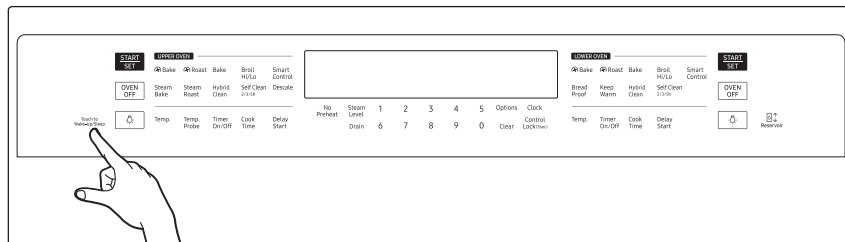

### Wake Mode

To wake the control panel, touch **Touch to Wake-Up/Sleep**. After 2 minutes without activity (or one minute when the oven is operating in standby mode), the control panel will return to Sleep mode.

### Select upper or lower oven

To change between the upper and lower oven, touch the **UPPER OVEN** or **LOWER OVEN** area.

The control panel will be activated after you select an oven.

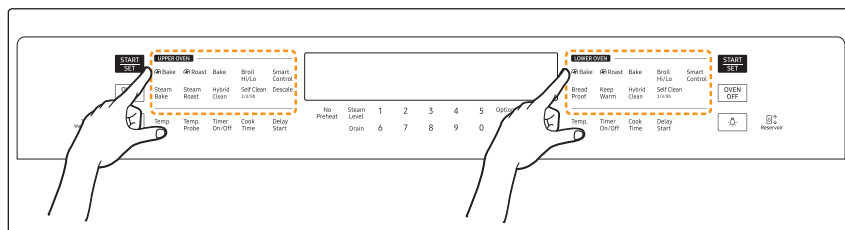

## Setting the clock

The clock must be set to the correct time of day for the automatic oven timing functions to work properly.

- The time of day cannot be changed during timed cooking, delay-timed cooking, or a self-cleaning cycle.
- You can choose between a 12-hour or 24-hour display. The default is 12-hour.

### How to set the clock

1. Touch **Clock**.
2. Touch **Clock** to select AM or PM. (Skip this step if you are setting the clock to 24 hour display mode.)
3. Touch keys in the **number pad** to set the current time of day.
4. Touch **Clock** or **START/SET** to save the changes.

## Setting the kitchen timer

The kitchen timer serves as an extra timer that will beep when the set time has elapsed. It does not start or stop cooking functions. You can use the kitchen timer with any of the other oven functions.

### How to set the timer

1. Touch **Timer On/Off**.
2. Touch number keys in the **number pad** to set the hours and minutes. The timer can be set for any amount of time from 1 minute to 9 hours and 59 minutes. If you make a mistake, touch **Clear**, and then enter the amount of time again.
3. Touch **Timer On/Off** or **START/SET**.
4. When the set time has elapsed, the oven will beep and the display will show End until you touch **Timer On/Off**. You can cancel the timer at any time by touching **Timer On/Off**.



## Control Lockout

Control Lockout lets you lock the buttons on the touch pad so they cannot be activated accidentally. You can only activate Control Lockout when the oven is in standby mode.

### How to activate the Control Lockout

1. Cancel or turn off all other functions.
2. Touch **Control Lock(3sec)** for 3 seconds.  
The oven will display "**Loc**" and the lock icon along with the current time.

### NOTE

- Control Lockout is available only when the oven temperature is under 400 °F.
- All other functions must be cancelled before you activate Control Lockout.

### How to unlock the controls

Touch **Control Lock(3sec)** for 3 seconds.  
"**Loc**" and the lock icon will disappear from the display.

## Timed Cooking

In Timed Cooking mode, the oven turns on immediately and cooks for the length of time you select. At the end of the cooking time, the oven turns off automatically.

- You can use the Timed Cooking only with another cooking operation (Convection Bake, Convection Roast, Bake, Steam Bake, Steam Roast, Bread Proof).

### How to set the oven for Timed Cooking

1. Touch the pad for the cooking operation you want, eg. **Bake**.  
Enter the temperature you want, for example, 400 °F, using the number pad. (The default temperature is 350 °F).
2. Touch **Cook Time**. Enter the number of hours/minutes you want the oven to stay on using the **number pad**. You can set the cooking time for any amount of time from 1 minute to 9 hours and 59 minutes.
3. Touch **START/SET** to begin cooking. The temperature display will start to change once the oven temperature reaches 175 °F.  
The oven will continue to cook until the set amount of time has elapsed, then turn off automatically unless you set the **keep Warm** feature. (Refer to the **Using Keep Warm (lower oven only)** section on page 30.)
4. You can cancel a cook time at any time by setting the cook time to 0 minutes. (Touch **Cook Time** -> set cook time to 0 min -> touch **START/SET**)

-  • When Timed Cooking is done, the oven will beep 10 times.

### CAUTION

Use caution with the **Timed Cooking** or **Delay Start** features. You can use these features to cook cured or frozen meats and most fruits and vegetables. For food that can easily spoil, such as milk, eggs, and unfrozen or fresh fish, meat, or poultry, chill them in the refrigerator first. Even when chilled, they should not stand in the oven for more than 1 hour before cooking begins, and should be removed promptly when cooking is completed. Eating spoiled food can result in sickness from food poisoning.



# Operating the oven

## Delay Start

With Delay Start, the oven's timer turns the oven on and off at times you select in advance.

- You can use the Delay Start only with another cooking operation (Convection Bake, Convection Roast, Bake, Steam Bake, Steam Roast, Self Clean).
- You can set the oven for a delay start before setting other cooking operations.
- The clock must be set to the current time.

### How to set the oven for delay start















1. Position the oven rack(s) and place the food in the oven.
2. Touch the pad for the cooking operation you want, eg. **Bake**. The default temperature is 350 °F.
3. Enter the temperature you want, eg. 375 °F, using the **number pad**.
4. Set the cooking time if you want. (Refer to the section on the timed cooking feature on page 21).
5. Touch **Delay Start**. Use the **number pad** to set the time.
6. Touch **START/SET**. At the set time, a short beep will sound. The oven will begin to cook.

## Turning the light on and off

- The oven light turns on and door light turns off automatically when the door is opened.
- The oven light turns off automatically when the door is closed.
- You can turn the oven and door light on and off manually by touching the **Lamp** .

## Minimum and maximum settings

All the features listed in the table below have minimum and maximum time or temperature settings. A beep will sound each time a pad on the control panel is pressed and the entry is accepted. An error tone will sound in the form of a long beep if the entered temperature or time is below the minimum or above the maximum setting for the feature.

FEATURE	MINIMUM	MAXIMUM
UPPER OVEN		
 Bake	175 °F (80 °C)	550 °F (285 °C)
 Broil	LO	HI
 Convection Bake	175 °F (80 °C)	550 °F (285 °C)
 Convection Roast	175 °F (80 °C)	550 °F (285 °C)
 Steam Bake	230 °F (110 °C)	550 °F (285 °C)
 Steam Roast	230 °F (110 °C)	550 °F (285 °C)
 Self Clean	2 Hr.	5 Hr.
 Hybrid Clean	-	2 Hr
LOWER OVEN		
 Bake	175 °F (80 °C)	480 °F (250 °C)
 Broil	LO	HI
 Convection Bake	175 °F (80 °C)	480 °F (250 °C)
 Convection Roast	175 °F (80 °C)	480 °F (250 °C)
 Keep Warm	-	3 Hr.
 Self Clean	2 Hr.	5 Hr.
 Hybrid Clean	-	2 Hr



## Using the oven racks

### Oven rack positions

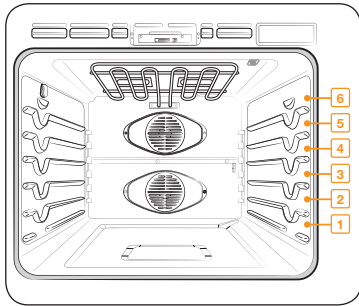

Recommended rack position for cooking

TYPE OF FOOD	RACK POSITION
Broiling hamburgers	6
Broiling meats or small cuts of poultry, fish	3-5
Bundt cakes, pound cakes, frozen pies, casseroles	4 or 3
Angel food cakes, small roasts	2
Turkey, large roast, hams, fresh pizza	1

- This table is for reference only.

### Rack and Pan placement

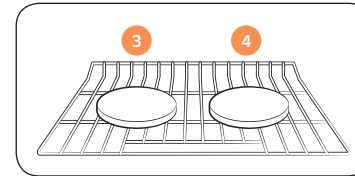

Single Oven Rack

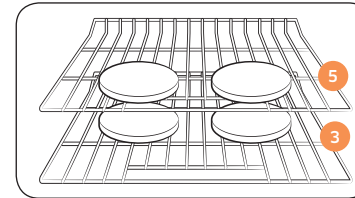

Multiple Oven Rack

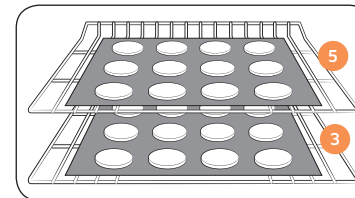

Multiple Oven Rack

Centering baking pans in the oven as much as possible will produce better results. If baking with more than one pan, place the pans so each has at least 1" to 1½" of air space around it.

When baking on a single oven rack, place the oven rack in **position 3 or 4**.

See the figure on the left.

When baking cakes and cookies on multiple racks, place the oven racks in **position 3 and 5**.

#### Using Multiple Oven Racks

Type of Baking	Rack Positions
Cakes and cookies	3 and 5

# Operating the oven

## Before using the racks

Each rack has stops that need to be placed correctly on the supports. These stops will keep the rack from coming completely out.

### REMOVING THE RACKS

1. Pull the rack straight out until it stops.
2. Lift up the front of the rack, and then pull it out.

### REPLACING THE RACKS

1. Place the end of the rack on the support.
2. Tilt the front end up and push the rack in.

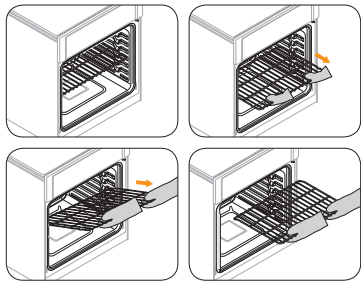

### ⚠ CAUTION

- Do not cover a rack with aluminum foil or place aluminum foil on the oven bottom. This will hamper heat circulation, resulting in poor baking, and may damage the oven bottom.
- Arrange the oven racks only when the oven is cool.

## Using the Gliding Rack

The fully extendable Gliding Rack makes food preparation easier, especially when you are preparing heavier dishes. The Gliding Rack has 2 glide tracks that allow you to extend the rack well out of the oven without touching the sides of the oven walls.

### Installing the Gliding rack

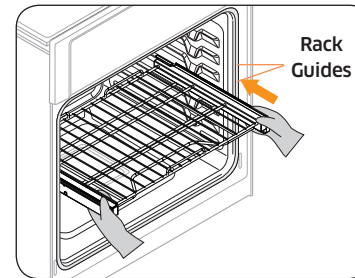

- With the Gliding Rack in the "Closed" position and the oven off, carefully insert the Gliding Rack between the guides until the rack reaches the back.

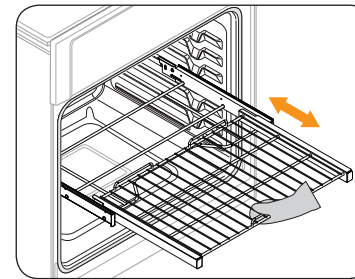

- When using the Gliding Rack in the oven, be sure to pull on the handle of the rack only to slide it in and out. If you grasp the frame while using the rack, the entire Gliding Rack will be removed. Make sure you use oven mitts when handling the Gliding Rack during cooking.



## Removing the Gliding Rack

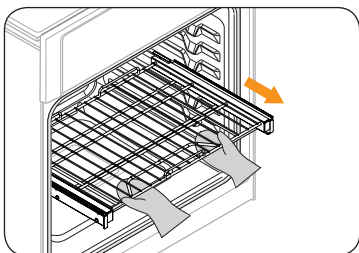

- With the Gliding Rack in the "Closed" position and the oven off and cool, grasp the rack and frame and pull both forward to remove.

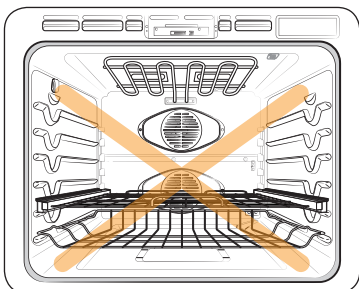

### ⚠ CAUTION

Do not install the Gliding Rack directly above the Flat Rack and Recessed rack. You will not be able to install it properly and the oven could fall.

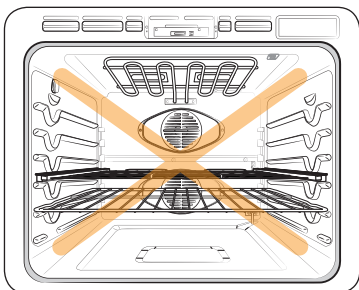

### 📖 NOTE

You can install the Gliding rack in any rack positions except the lowest (level 1) rack position in the oven.

## Baking

The oven can be programmed to bake at any temperature from 175 °F to 550 °F. Baking temperature and time will vary depending on the ingredients and the size and shape of the baking pan used. Dark or nonstick coatings may cook faster with more browning.

### How to set the oven for baking

1. Touch **Bake**.
2. Enter the temperature you want using the **number pad**, eg. 3, 7, 5.
3. Touch **START/SET**. The temperature display will start to change once the oven temperature reaches 175 °F.
4. If you want to cancel baking or if you have finished, touch **OVEN OFF**.



- Place food in the oven after preheating if the recipe calls for it. Preheating is very important for good results when baking cakes, cookies, pastry, and breads. After the oven has reached the desired temperature, the oven will beep 6 times.

### 📖 NOTE

- For performance reasons, the convection fan may turn on or off during baking.
- If you are using an oven thermometer in the oven cavity, the temperature registered by the thermometer may differ from the actual set oven temperature.

### How to adjust the temperature while cooking

1. Touch **Temp.**. The display will show the present temperature, eg. 375 °F.
2. Enter the temperature you want, eg. 425 °F, using the **number pad**.
3. Complete the entry by touching **START/SET**.

# Operating the oven

## Convection baking

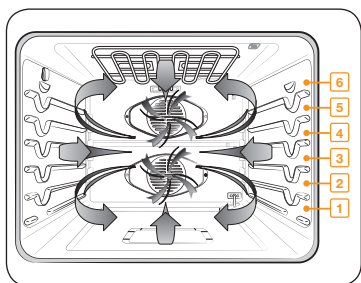

By using the Convection Bake, you will be able to cook faster. Convection baking uses a fan to circulate the oven's heat evenly and continuously within the oven. This improved heat distribution allows for even cooking and excellent results while using multiple racks at the same time. Foods cooked on a single oven rack will generally cook faster and more evenly with convection baking. Multiple oven rack cooking may have slightly increased cooking times for some foods, but the overall result is time saved. Breads and pastries brown more evenly. You can program the oven for convection baking at any temperature between 175 °F and 550 °F.

### Tips for convection baking

The amount of time you save will vary depending on the amount and type of food you are cooking. When baking cookies or biscuits, you should use pans with no sides or very low sides to allow the heated air to circulate around the food. Using a pan with a dark finish will produce faster cooking times.

When using convection baking with a single rack, place the oven rack in **position 3** or **4**. If cooking on multiple racks, place the oven racks in **position 3** and **5**.

When baking a cake, using the bake mode (not the convection bake mode) will produce better results.

### How to set the oven for convection baking

1. Touch **Bake. No Preheat** key is activated on the control panel. Touch **No Preheat** if you want to use the No Preheat feature. (Refer to the **No Preheat** section on page 27.)
2. Enter the temperature you want, eg. 400 °F, using the **number pad**.
3. Touch **START/SET**.  
The temperature display will start to change once the oven temperature reaches 175 °F.  
The oven will beep 6 times when the oven reaches the adjusted oven temperature.
4. If you want to cancel convection baking or if you have finished, touch **OVEN OFF**.



- The convection oven fan shuts off when the oven door is opened.
- DO NOT leave the door open for long periods of time while using convection cooking or you may shorten the life of the convection heating element.

### NOTE

- If you leave the oven door open for more than 2 minutes when the oven is on, all heating elements will shut off automatically.
- When you have finished cooking, the cooling fan will continue to run until the oven has cooled down.

### NOTE

- For performance reasons, the convection fan may turn on or off during baking.
- If you are using an oven thermometer in the oven cavity, the temperature registered by the thermometer may differ from the actual set oven temperature.

## Convection roasting

Convection roasting is good for cooking large tender cuts of meat uncovered. Heat comes from the top heating element. The convection fan circulates the heated air evenly over and around the food. Meat and poultry are browned on all sides as if they were cooked on a rotisserie. The heated air seals in juices quickly for moist and tender results while, at the same time, creating a rich golden brown exterior.

### How to set the oven for convection roasting

1. Touch **Roast. No Preheat** is activated on the control panel. Touch **No Preheat** if you want to use the No Preheat feature. (Refer to the **No Preheat** section on this page.)
2. Enter the temperature you want, eg. 400 °F, using the **number pad**.
3. Touch **START/SET**.  
The temperature display will start to change once the oven temperature reaches 175 °F. The oven will beep 6 times when the oven reaches the adjusted oven temperature.
4. If you want to cancel convection roasting or if you have finished, touch **OVEN OFF**.

- The convection oven fan shuts off when the oven door is opened.
- DO NOT leave the door open for long periods of time while using convection cooking or you may shorten the life of the convection heating element.

### NOTE

- If you leave the oven door open for more than 2 minutes when the oven is on, all heating elements will shut off automatically.
- When you have finished cooking, the cooling fan will continue to run until the oven has cooled down.

### NOTE

- For performance reasons, the convection fan may turn on or off during roasting.
- If you are using an oven thermometer in the oven cavity, the temperature registered by the thermometer may differ from the actual set oven temperature.

## No Preheat

Use No Preheat to cook without the pre-heating cycle. This function is only available for Convection Bake and Convection Roast.

### How to set the oven for No Preheat

1. Touch **Bake** or **Roast. No Preheat** is activated on the control panel.
2. Touch **No Preheat**.
3. Enter the temperature you want, eg. 400 °F, using the **number pad**.
4. Touch **START/SET**.
5. The temperature display will show the set temperature.

### NOTE

- For best performance, we recommend cooking on single rack.

Type	Rack Positions
Baking	3 or 4
Roasting	1 or 2

- Place food in the oven before you start cooking when using the No Preheat feature.
- For best performance, preheat the oven when baking rising bakery products such as angel food cakes, Bundt cakes, or puff pastries.

# Operating the oven

## Broiling

Broiling is a method of cooking tender cuts of meat by direct heat under the broil element of the oven.

The high heat cooks quickly and gives a rich, brown outer appearance. Broil mode is best for meats, fish, and poultry up to 1" thick.

### How to set the oven for broiling

1. Touch **Broil** once for Hi or twice for Lo.  
Use Lo to cook foods such as poultry or thick cuts of meat thoroughly without over-browning them.
2. To start broiling, touch **START/SET**.  
Broil one side until the food is browned. Turn over and broil the other side.
3. Touch **OVEN OFF** once you have finished cooking or if you want to cancel broiling.

### NOTE

- This oven is designed for CLOSED DOOR broiling. The oven door must be closed during broiling.
- If you leave the oven door open for more than 2 minutes when the oven is on, all heating elements will shut off automatically.
- When you have finished cooking, the cooling fan will continue to run until the oven has cooled down.
- If you are using an oven thermometer in the oven cavity, the temperature registered by the thermometer may differ from the actual set oven temperature.

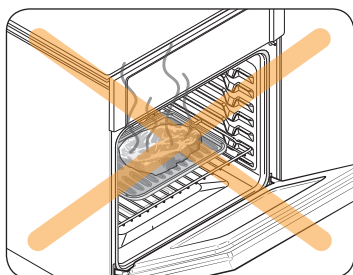

### CAUTION

Always broil with the oven door closed. Use care when opening the door. Let hot air or steam escape before you remove food from or put food into the oven.

## Broiling recommendation guide

The size, weight, thickness, starting temperature, and your doneness preference will affect broiling times. This guide is based on meats at refrigerator temperature. Always use a broiler pan and its grid when broiling. Always preheat the oven for 5 minutes before broiling.

Food	Doneness	Size	Thickness	Level	Rack position	Cooking time (min)	
						1st side	2nd side
Hamburgers	Medium	9 patties	3/4"	Hi	6	3:00	2:00
	Medium	9 patties	1"	Hi	6	3:20	2:20
Beef steaks	Rare	-	1"	Hi	5	5:00	4:00
	Medium	-	1- 1 1/2"	Hi	5	6:00-6:30	4:30-4:00
	Well done	-	1- 1 1/2"	Lo	4	7:00-8:00	4:00-5:00
Chicken pieces	Well done	4.5 lbs.	1/2-3/4"	Lo	3	16:00-18:00	13:00-15:00
	Well done	2 lbs.	1/2-3/4"	Lo	3 or 4	15:00-16:00	10:00-12:00
Pork chops	Well done	1 lbs.	1"	Lo	3	8:00-10:00	6:00-8:00
Fish fillets	Well done	-	1/4-1/2"	Lo	3 or 4	7:00-8:00	4:00-5:00

## Steam baking and roasting (upper oven only)

Steam Bake provides excellent baking conditions for breads, pastries, and desserts by increasing moisture content and improving texture and flavor.

Steam Roast provides excellent cooking conditions for roasted meats or poultry by maintaining a crispy surface while sealing in the juices for a moist and tender result.

1. Open the door and Touch **Reservoir** . Then, pull out the water reservoir.
2. Fill the water reservoir with 22 oz (650ml) of water, close the reservoir cap, re-insert the reservoir, and then touch **Steam Bake** or **Steam Roast**.
3. Touch **Steam Level** once for Med, twice for Hi, or 3 times for Lo. (Default is Lo.)  
The display will show and the steam level.
4. Enter the temperature you want, eg.400 °F, using the **number pad**.
5. Touch **START/SET**.

The temperature display will start to change once the oven temperature reaches 175 °F. The oven will beep 6 times when the oven reaches the set oven temperature.

6. If you want to cancel steam baking or steam roasting or if you have finished, touch **OVEN OFF**.

### NOTE

- When Steam Bake or Steam Roast is enabled and the water reservoir runs out of water, display will show “**Water Supply**”.  
The oven continues to operate but the steam generator stops operation until you refill the water reservoir with water.
- Make sure to drain the remaining water after using Steam Bake and Steam Roast. Once the oven starts draining, please wait until the draining cycle is complete.
- When Steam Bake and Steam Roast is complete, you must empty the water reservoir because the remaining water can affect other cooking modes.

- The convection oven fan shuts off when the oven door is opened.
- DO NOT leave the door open for long periods of time while using convection cooking or you may shorten the life of the convection heating element.

### NOTE

- If you leave the oven door open for more than 2 minutes when the oven is on, all heating elements will shut off automatically.
- When you have finished cooking, the cooling fan will continue to run until the oven has cooled down.

### NOTE

- For performance reasons, the convection fan may turn on or off during cooking.
- If you are using an oven thermometer in the oven cavity, the temperature registered by the thermometer may differ from the actual set oven temperature.

### Steam cook recommendation guide

Steam mode	level	Foods
Steam Bake	High	Rye breads, <a href="#">Desserts (Flan caramel)</a>
	Med	Croissants, Pies, <a href="#">Reheats (Pizza, Casserole)</a>
	Low	Pastries
Steam Roast	High	-
	Med	Meats, Poultry
	Low	Turkey, Large meats

## Operating the oven

### Using Bread Proof (lower oven only)

Bread Proof automatically provides the optimum temperature for the bread proof process, and therefore does not have a temperature adjustment.

If you touch Bread Proof when the oven temperature is above 100 °F, Hot will appear in the display.

Because this function produces the best results when started while the oven is cool, we recommend that you wait until the oven has cooled down and Hot disappears from the display.

1. Touch **Bread Proof**.
2. Touch **START/SET**.
3. Touch **OVEN OFF** at any time to turn off Bread Proof.

#### NOTE

Use rack position 3 for Bread Proof.

### Using Keep Warm (lower oven only)

Keep Warm will keep cooked food warm for serving up to 3 hours after cooking has finished.

After 3 hours, the feature will shut off automatically. You can use the Keep Warm feature without any other cooking operations or you can set it to activate after a timed or delay timed cooking operation.

You should not use this feature to reheat cold food.

#### How to use Keep Warm

1. Touch **Keep Warm**.
2. Touch **START/SET**.
3. Touch **OVEN OFF** at any time to turn the feature off.

#### How to set the oven to activate Keep Warm after a timed cooking

1. Set up the oven for **Timed cooking**.  
(Refer to **Timed Cooking** section on page 21.)
2. Touch **Keep Warm** before touching **START/SET** to begin cooking.
3. Touch **OVEN OFF** at any time to turn the feature off.

### Using the Temp Probe (upper oven only)

For many foods, especially roasts and poultry (beef, chicken, turkey, pork, lamb, etc), measuring the internal temperature is the best way to determine if the food is properly cooked.

The Temp Probe lets you cook meat to the exact internal temperature you want, taking the guess work out of determining whether a piece of meat is done or not. This function can be used with Bake, Convection Bake, or Convection Roast. After the internal temperature of the food reaches 100 °F, the increasing internal temperature will be shown in the display.

#### How to use the Temp Probe

1. Push the tip of the temp probe into the meat as fully as possible, so that the tip is in the center of the meat.

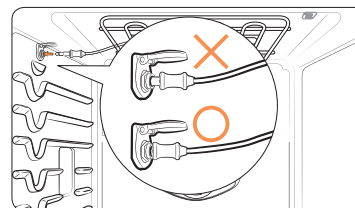
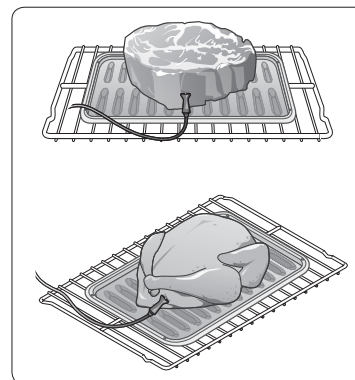

- Insert the probe completely into the meat as shown in the illustrations. It should not touch bone, fat, or gristle.
- If you do not fully insert the probe into the meat, the Temp. Probe function will not work correctly because the probe will sense the oven temperature, not the temperature of the meat.
- For bone-in meats, insert the probe into the center of the lowest and thickest portion of the piece.
- For whole poultry (turkey, large chickens, etc.), insert the probe into the thickest part of the inner thigh, parallel to the leg.
- If you activate Keep Warm to keep the meat warm after you have cooked it using the Temp. Probe function, the meat's internal temperature will exceed the temperature you want.

2. Insert the temp probe plug into the socket on the top side wall of the oven as far as it will go.
3. Select the desired cooking function (Bake, Convection Bake, or Convection Roast) and temperature.
4. Touch **Temp. Probe** to set the desired internal temperature.
5. Set the desired internal temperature using the **number pad**.

Available temperatures	100 °F to 200 °F
------------------------	------------------

6. If you want to use Cook Time, Delay Start, or Keep Warm, set each function.
7. Touch **START/SET**.
8. When the desired internal temperature is reached, the function automatically stops and an alarm sounds.

 **CAUTION**

To protect the Temp Probe's tip, be careful not to insert the probe so that the tip protrudes through the surface of the meat. Make sure that the tip is in or near the center of the meat.

 **CAUTION**

- Do not store the probe in the oven.
- Do not leave the probe inside the oven during a self-cleaning or broiling cycle. You can permanently damage the probe and it will no longer work.
- To avoid breaking the probe's tip, defrost your food completely.
- Do not use tongs when inserting or removing the probe. Tongs can damage the probe.
- Use the Temp Probe for Temp. Probe function cooking only. Do not use the Temp Probe for any other purpose.

 **NOTE**

- If you remove the Temp Probe while the Temp. Probe function is operating or insert the Temp Probe while baking or cooking normally, cooking will stop after 1 minute.
- If you use the probe to cook frozen food, there are times when it cannot be detected. (the Temp. Probe icon doesn't show in the display.)

**Temp Probe table**

Type of Food		Internal temperature
Beef / Lamb	Rare	140 °F
	Medium	160 °F
	Well done	170 °F
Pork		170 °F
Poultry		180-185 °F

 **NOTE**

If you cover the meat with aluminum foil and allow it to stand for 10 minutes after cooking, the Internal temperature will rise 5-10 degrees.

**Removing the Temp Probe**

Remove the temp probe plug from the socket.

 **CAUTION**

After cooking, the Temp Probe is hot enough to cause burns.

# Operating the oven

## Using Smart Control

To use the oven's Smart Control, you must download Samsung's Smart Home app to a mobile device. Functions that can be operated using Samsung's Smart Home app may not work smoothly if communication conditions are poor or the oven is installed in a place with a weak Wi-Fi signal.

Please refer to the following table for the main functions that can be operated from the app.

When Smart Control on the oven is off	Monitoring (Oven, Probe), Oven off
When Smart Control on the oven is on.	Monitoring (Oven, Probe), Oven start, Oven off, Error check

### How to connect the oven

1. Download and open the Samsung Smart Home app on your smart device.
2. Follow the app's on-screen instructions to connect your oven.
3. Once the process is complete, the connected  icon located on your oven displays and the app will confirm you are connected.
4. If the connection icon does not turn on, follow the instruction in the app to reconnect.

### To start the oven remotely

1. Touch **Smart Control**.  appears in the display. The oven can now be started and controlled remotely by a connected mobile device.



### When Smart Control is on you can:

- Remotely change oven settings (mode, time, temperature) using your mobile device.
- Remotely start the oven.
- Remotely turn off the oven.
- Once cooking starts, you can change the cooking time and temperature remotely.

### NOTE

**Important:** Self clean mode cannot be started remotely.

### NOTE

- Opening the oven door or touching **Smart Control** will delete  from the display and prevent you from turning the oven on or controlling the oven remotely.
- If  is not shown in the display, you can still monitor the oven's status and turn the oven off.
- When oven cooking is finished or cancelled,  will turn off.

## Using Options

This function lets you control various electronic control options. These options include Temp Adjust, Temp Unit, Auto Conversion, Time of Day, 12 hour energy saving, Sound On/Off, and Demo mode.

The option menu is only available when the oven is not being used (not cooking).

Options	Feature
<b>1. Temp Adjust</b>	Lets you correct the temperature in the oven.
<b>2. Temp Unit</b>	Lets you program the oven control to display temperatures in Fahrenheit or Centigrade.
<b>3. Auto Conversion</b>	Lets you set the Auto Conversion feature so that the oven automatically converts entered regular baking temperatures to convection baking temperatures, and then displays the convection temperatures.
<b>4. Time of Day</b>	Lets you set the clock to display the time of day in the 12 hour or 24 hour mode.
<b>5. 12 hour energy saving</b>	This feature automatically turns off the oven after 12 hours during baking functions or after 3 hours during a broil function.
<b>6. Sound On/Off</b>	Lets you set the oven controls to operate silently.
<b>7. Wi-Fi On/Off</b>	Lets you activate and de-activate the oven's wi-fi connection.
<b>0. Demo mode</b>	This option is for use by retail establishments for display purposes only.



## Temp Adjust

The temperature in the oven has been calibrated at the factory. When first using the oven, be sure to follow recipe times and temperatures. If you think the oven is too hot or too cool, you can correct the temperature in the oven. Before correcting, test a recipe by using a temperature setting that is higher or lower than the recommended temperature. The baking results should help you to decide how much of an adjustment is needed.

The oven temperature can be adjusted  $\pm 35^{\circ}\text{F}$  ( $\pm 19^{\circ}\text{C}$ ).

### How to correct the oven temperature

1. Touch **Options**, and then **1** on the **number pad**.
2. Touch **Options** to select higher or lower than the current temperature.
3. Enter the adjustment you want to make using the **number pad**. (0-35)
4. Touch **START/SET** to save the changes.

### NOTE

This adjustment will not affect the broiling or the self-cleaning temperatures. The adjustment will be retained in memory after a power failure.

## Temp Unit (Fahrenheit or Celsius temperature selection)

You can program the oven control to display the temperature in Fahrenheit or Celsius. The oven has been preset at the factory to display in Fahrenheit.

### How to change the display from Fahrenheit to Celsius or Celsius to Fahrenheit

1. Touch **Options**, and then **2** on the **number pad**.
2. Touch **1** (Fahrenheit) or **2** (Celsius) on the **number pad**.
3. Touch **START/SET** to save the changes.

## Auto Conversion

When you use the auto conversion feature, the convection auto conversion feature will automatically convert entered regular baking temperatures to convection baking temperatures.

If this feature is activated, the display will show the actual converted (reduced) temperature. For example, if you enter a regular recipe temperature of  $350^{\circ}\text{F}$  and touch Oven Start/Set, the display will show the converted temperature of  $325^{\circ}\text{F}$ . (Default setting : off)

### How to enable or disable the auto conversion feature

1. Touch **Options**, and then **3** on the **number pad**.
2. Touch **1** (On) or **2** (Off) on the **number pad**.
3. Touch **START/SET** to save the changes.

## Time of Day (12hr/24hr)

The oven control can be programmed to display time of day in the 12 hour or 24 hour mode.

The oven has been preset at the factory to display in the 12 hour mode.

### How to change between the 12 and 24 hour time of day display

1. Touch **Options**, and then **4** on the **number pad**.
2. Touch **1** (12hr) or **2** (24hr) on the **number pad**.
3. Touch **START/SET** to save the changes.

## 12 hour energy saving

If you accidentally leave the oven on, this feature will automatically turn off the oven after 12 hours during baking functions or after 3 hours during a broil function.

### How to turn the 12 hour energy saving feature on or off

1. Touch **Options**, and then **5** on the **number pad**.
2. Touch **1** (On) or **2** (Off) on the **number pad**.
3. Touch **START/SET** to save the changes.



# Operating the oven

## Sound On/Off

Using Sound On/OFF, you can set the oven controls to operate silently.

### How to turn the sound on or off

1. Touch **Options**, and then **6** on the **number pad**.
2. Touch **1** (On) or **2** (Off) on the **number pad**.
3. Touch **START/SET** to save the changes.

## Wi-Fi On/Off

You can turn the oven's Wi-Fi connection on or off.

### How to turn the Wi-Fi on or off

1. Touch **Options**, and then **7** on the **number pad**.
2. Touch **1** (On) or **2** (Off) on the **number pad**.
3. Touch **START/SET** to save the changes.

### NOTE

When you turn the oven's Wi-Fi connection off, Users can't set to easy setup.

## Demo mode

This option is for use by retail establishments for display purposes only. (When Demo mode is on, the heating element is disabled and does not operate.)

### How to enable or disable the demo mode

1. Touch **Options**, and then **0** on the **number pad**.
2. Touch **1** (On) or **2** (Off) on the **number pad**.
3. Touch **START/SET** to save the changes.

## Using the Sabbath feature

(For use on the Jewish Sabbath & Holidays)



For further assistance, guidelines for proper usage, and a complete list of models with the Sabbath feature, please visit <http://www.star-k.org>.

You can use the Sabbath feature with baking only. The oven temperature may be set higher or lower after you set the Sabbath feature. (The oven temperature adjustment feature should be used only during Jewish holidays.) The display, however, will not change and tones will not sound when a change occurs. Once the oven is properly set for baking with the Sabbath feature active, the oven will remain on continuously until the Sabbath feature is cancelled. This will override the factory preset 12 hour energy saving feature. If the oven light is needed during the Sabbath, touch  before activating the Sabbath feature. Once the oven light is turned on and the Sabbath feature is active, the oven light will remain on until the Sabbath feature is turned off. If the oven light needs to be off, be sure to turn the oven light off before activating the Sabbath feature.

### How to use the Sabbath feature

1. Touch **Bake**. The default temperature is 350 °F.
2. Enter the temperature you want, eg. 375 °F, by using the **number pad**.
3. Touch **START/SET**.  
The temperature display will start to change once the oven temperature reaches 175 °F.
4. Touch **Bake** and **Touch to Wake-Up/Sleep** at the same time for 3 seconds. The display will show **SAB**.  
Once SAB appears in the display, the oven will not beep or display any further changes.  
You may change the oven temperature once baking has started. Remember that the oven will not beep or display any further changes once the Sabbath feature is engaged.
5. You can turn the oven off at any time by touching **OVEN OFF**. This will turn only the oven off. If you want to deactivate the Sabbath feature, hold down **Bake** and **Touch to Wake-Up/Sleep** at the same time for 3 seconds. SAB will disappear from the display.





## Maintaining your appliance



Do not attempt to activate any other program feature except Bake while the Sabbath feature is active. ONLY the following key pads will function correctly with the Sabbath feature on: **Number, Bake, START/SET** and **OVEN OFF**. All other keys should not be used once the Sabbath feature is activated.



You can change the oven temperature, but the display will not change and tones will not sound when a change occurs. (The oven temperature adjustment feature should be used only on Jewish holidays.) After changing the temperature while the unit is in Sabbath mode, there is a 15 second delay before the unit recognizes the change.



You can set the Cook time function before activating the Sabbath feature.



Should there be a power failure or interruption, the oven will shut off. When power is returned, the oven will not turn back on automatically. SAb will be displayed in the oven control display, but the oven will not operate. Food may be safely removed from the oven while it is still in the Sabbath mode, however the oven cannot be turned back on until after the Sabbath/Holidays. After the Sabbath observance, turn OFF the Sabbath mode. Touch and hold both **Bake** and **Touch to Wake-Up/Sleep** for at least 3 seconds simultaneously to turn the Sabbath mode off. The oven can then be used with all normal functions.



Do not open the oven door or change the oven temperature for about 30 minutes after you have started Sabbath mode to allow the oven to reach the set temperature. Note that, for best performance, the oven fan operates only when the oven temperature is rising.

### Self-cleaning

This self-cleaning oven uses high temperatures (well above cooking temperatures) to burn off leftover grease and residue completely or reduce them to a finely powdered ash that you can wipe away with a damp cloth.

#### CAUTION

- During the self-cleaning cycle, the outside of the oven will become very hot to the touch. **Do not** leave small children unattended near the appliance.
- Some birds are extremely sensitive to the fumes given off during the self-cleaning cycle of any oven. Move birds to another well-ventilated room.
- **Do not** line the oven walls, racks, bottom, or any other part of the oven with aluminum foil. Doing so will result in poor heat distribution, poor baking results, and cause permanent damage to the oven interior. Aluminum foil will melt and adhere to the interior surface of the oven.
- The oven door locks during self-cleaning. **Do not** force the oven door open. This can damage the automatic door locking system. Use care when opening the oven door after the self-cleaning cycle is complete. Stand to the side of the oven when opening the door to allow hot air or steam to escape. The oven may still be **VERY HOT**.

# Maintaining your appliance

## Before a self-cleaning cycle

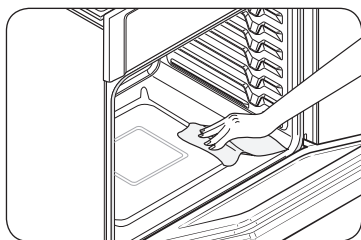

Fig. 1

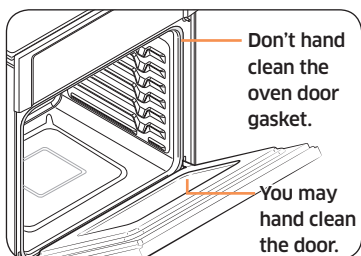

Fig. 2

- We recommend venting your kitchen with an open window or using a ventilation fan or hood during the self-cleaning cycle.
- Remove the wire rack, broil pan, broil pan insert, all cookware, and any aluminum foil from the oven.
- Wipe up debris from the oven bottom. (Fig. 1)
- The silver-colored oven racks can be self-cleaned, but they will darken, lose their luster, and become hard to slide.
- Residue on the front frame of the oven and outside the gasket on the door will need to be cleaned by hand. Clean these areas with hot water, soap-filled steel-wool pads, or cleansers such as Soft Scrub. Rinse well with clean water and dry.
- Do not clean the gasket. The fiberglass material of the oven door gasket cannot withstand abrasion. It is essential for the gasket to remain intact. If you notice it becoming worn or frayed, have it replaced. (Fig. 2)
- Make sure the oven light cover is in place and the oven light is off.

### NOTE

Remove oven racks and accessories before starting the self-clean mode.

## How to run a self-cleaning cycle

1. Select the length of time for the self-cleaning operation, eg. 3 hours. Touch **Self Clean 2/3/5h** once for a 3 hour clean time, twice for a 5 hour clean time, or 3 times for a 2 hour clean time. The default setting is 3 hours.
2. Touch **START/SET** to start the self-cleaning cycle. The motor-driven door lock will engage automatically.

### NOTE

- You will not be able to start a self-cleaning cycle if the Control Lockout feature is activated or if the oven's temperature is too hot.
  - The oven door locks automatically. The display will show the cleaning time remaining. You cannot open the oven door until the temperature drops to a safe/cool temperature.
  - The self-clean feature can be used in only one oven at a time. While one oven is in self-cleaning mode, you cannot use the other oven for cooking.
3. When the self-cleaning cycle is done, End will appear in the display and the oven will beep 6 times.

## How to delay the start of self-cleaning

1. Touch **Self Clean 2/3/5h**. Select the desired self-clean time by touching **Self Clean 2/3/5h**.
2. Touch **Delay Start**.
3. Enter the time you want the self-clean cycle to start.
4. Touch **START/SET**. The display will show Delay, Self clean, and the Lock icon. The motor-driven door lock will engage automatically.
5. The Self-Cleaning cycle will turn on automatically at the set time.

## How to turn off the self-cleaning feature

If you need to stop or interrupt a self-cleaning cycle:

1. Touch **OVEN OFF**.
2. You will be able to open the oven door once the oven has cooled down for approximately 1 hour.

### After a self-cleaning cycle

- You may notice some white ash in the oven. Wipe it up with a damp cloth after the oven cools. (If white spots remain, remove them with a soap-filled steel wool pad and rinse thoroughly with a vinegar and water mixture.)
- If the oven is not clean after one cycle, repeat the cycle.
- You cannot set the oven for cooking until the oven is cool enough for the door to unlock.

## Hybrid Cleaning

The Hybrid cleaning function saves time and energy by removing leftover grease and residue that you can then wipe away with a damp cloth.

### ⚠ CAUTION

- **Do not** line the oven walls, racks, bottom, or any other part of the oven with aluminum foil. Doing so will result in poor heat distribution, poor baking results, and cause permanent damage to the oven interior. Aluminum foil will melt and adhere to the interior surface of the oven.
- The oven door locks during Hybrid cleaning. **Do not** force the oven door open. This can damage the automatic door locking system. Use care when opening the oven door after a Hybrid Cleaning cycle is complete. Stand to the side of the oven when opening the door to allow hot air or steam to escape.

### Before a Hybrid cleaning cycle

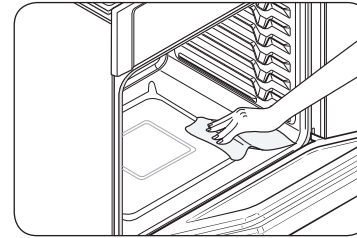

Fig. 1

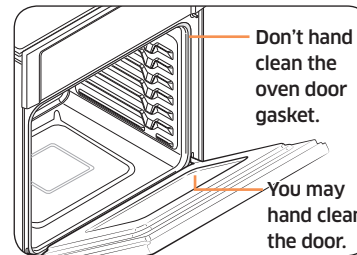

Fig. 2

- Remove the wire rack, broil pan, broil pan insert, all cookware, and any aluminum foil from the oven.
- Wipe up debris from the oven bottom. (Fig. 1)
- The silver-colored oven racks can be Hybrid Cleaned, but they will darken, lose their luster, and become harder to slide.
- Residue on the front frame of the oven and outside the gasket on the door will need to be cleaned by hand. Clean these areas with hot water, soap-filled steel-wool pads, or cleansers such as Soft Scrub. Rinse well with clean water and dry.
- Do not clean the gasket. The fiberglass material of the oven door gasket cannot withstand abrasion. It is essential for the gasket to remain intact. If you notice it becoming worn or frayed, have it replaced. (Fig. 2)
- Make sure the oven light cover is in place and the oven light is off.

### 📖 NOTE

Remove oven racks and accessories before starting the Hybrid clean mode.

# Maintaining your appliance

## How to run a Hybrid cleaning cycle

1. Remove all accessories from the oven.
2. Pour approximately **20 oz (600ml)** of water into the water reservoir, and then close the oven door.  
Use normal water only, not distilled water.
3. Touch **Hybrid Clean**.
4. Touch **START/SET**. The motor-driven door lock will engage automatically.  
When the operation is complete, the display will blink and a beep will sound.
5. Touch **OVEN OFF**.
6. Clean the oven's interior. There will be a significant amount of water remaining on the bottom of the oven after a Hybrid cleaning cycle. Remove the residual water with a sponge or soft cloth.

### **NOTE**

For Hybrid Cleaning, use exactly **20 oz (600ml)** of water since this produces the best results.

## After a Hybrid cleaning cycle

- Take care when opening the door after a Hybrid cleaning procedure has ended. The water on the bottom is hot.
- Open the oven door and remove the remaining water with a sponge. Do not leave the residual water in the oven for any length of time. Wipe the oven clean and dry with a soft cloth. Do not forget to wipe under the oven door seal.
- Use a detergent-soaked sponge, a soft brush, or a nylon scrubber to wipe the oven interior. Remove stubborn residue with a nylon scourer. You can remove lime deposits with a cloth soaked in vinegar.
- If the oven remains dirty, you can repeat the procedure once the oven has cooled.
- For heavy residue, such as grease left over from roasting, we recommend that you rub detergent into the residue before activating the Hybrid cleaning function.
- After cleaning, leave the oven door ajar at a 15° angle to allow the interior enamel surface to dry thoroughly.

### **NOTE**

- You will not be able to start a Hybrid cleaning cycle if the control lockout feature is activated or if the oven's temperature is too hot.
- The oven door locks automatically. The display will show the cleaning time remaining. You cannot open the oven door until the temperature drops to a safe/cool temperature.
- The Hybrid clean feature can be used in only one oven at a time. While one oven is in Hybrid cleaning mode, you cannot use the other oven for cooking.
- If the oven is not clean after one cycle, repeat the cycle.
- You cannot set the oven for cooking until the oven is cool enough for the door to unlock.

## Descal

If you use Steam Bake or Steam Roast frequently, we recommend descaling regularly to remove minerals from the oven that may affect the taste or quality of food cooked. When running a descaling cycle, use only descaling agents that are specific to steam ovens or coffee machines.

### NOTE

If you use Steam Bake or Steam Roast functions for more than a total of 12 hours, the Descal indicator turns on. You can still enable the Steam Bake or Steam Roast functions for the next two hours without descaling. However, after those two hours are up, the Steam Bake or Steam Roast functions will be disabled until you run a descaling cycle.

1. Touch **Reservoir** .
2. Empty and clean the water reservoir, and then fill it with 1.75 oz (50 ml) of descaling agent and 13.5 oz (400 ml) of water.
3. Touch **Descal**.
4. Touch **START/SET**. The oven starts descaling. The Descaling cycle has 5 steps. The display will notify you as each step occurs. Below are step 1 through 3.

Step 1	Apply descaling agents	Approx. 2 min.
Step 2	Descaling	Approx. 3 hrs.
Step 3	Draining	Approx. 4 min.

5. When the oven reaches step 4, you will see **"Out"** on the display. Remove and empty the water reservoir, and then refill it with **22 oz (650ml)** of drinkable water. Reinsert the reservoir. The **"In"** message that appears momentarily will disappear.
6. Touch **START/SET**. The oven continues to rinse and drain for 5 minutes, and then moves to step 5.
7. When Step 5 is complete, you will see **"Out"** on the display. Remove and clean the water reservoir, and then reinsert.
8. Touch **START/SET**. The oven beeps, indicating descaling is complete.

### WARNING

Use only descaling agents that are specific to steam ovens or coffee machines.

### CAUTION

- The Water Supply LED blinks and the oven stops operating if the water reservoir runs out of water during the descaling cycle. If this happens, refill the reservoir so that the reservoir contains **22 oz (650ml)** of drinkable water. Do not overfill the reservoir. Otherwise, water may leak from the water reservoir.
- Do not cancel descaling while it is in process. If you stop it, you must restart the descaling cycle and complete it within the next three hours to enable the Steam Bake or Steam Roast functions.
- To avoid accidents, keep children away from the oven.
- For the correct ratio of water and the descaling agent, follow the agent manufacturer's instructions. If the ratio of water to descaling agent differs from the instructions here (8 to 1), use the ratio indicated in the instructions for the descaling agent.

### NOTE

Although the oven automatically starts descaling in 5 seconds without your confirmation, we recommend that you confirm your selection. This is to prevent descaling from starting by mistake.

## Draining

When a steam function is complete, you must drain the remaining water to prevent the water from affecting other cooking modes.

To drain the water, follow these steps:

1. Touch **Drain**. The oven drains water from the steam generator to the water reservoir.
2. When draining is complete, use oven gloves to remove and empty the water reservoir.

# Maintaining your appliance

## Care and cleaning of the oven

### Cleaning painted parts and decorative trim

- For general cleaning, use a cloth with hot, soapy water.
- For more difficult residue and built-up grease, apply a liquid detergent directly onto the area and leave for 30 to 60 minutes. Wipe with a damp cloth and dry. Do not use abrasive cleaners on any oven surface. They can be scratched.

### Cleaning stainless steel surfaces

1. Shake a bottle of Stainless Steel Appliance Cleaner or Polish well.
2. Place a small amount of stainless steel appliance cleaner or polish on a damp cloth or damp paper towel.
3. Clean a small area, rubbing with the grain of the stainless steel if applicable.
4. Dry and buff with a clean, dry paper towel or soft cloth.
5. Repeat as necessary.

#### NOTE

- **Do not use a steel-wool pad. It will scratch the surface.**
- If a mineral oil-based stainless steel appliance cleaner has been used before to clean the appliance, wash the surface with dishwashing liquid and water prior to using the Stainless Steel Appliance Cleaner or Polish.

### Oven racks

- If the racks are left in the oven during a self-cleaning cycle, their color will turn slightly blue and the finish will be dull. After the self-cleaning cycle is complete and the oven has cooled, rub the sides of the racks with wax paper or a cloth containing a small amount of oil. This will help the racks glide more easily on their tracks.
- Gliding racks may be cleaned by hand with an abrasive cleaner or steel wool. During cleaning, be careful not to allow water or cleaner to enter the slides on the sides of rack.

#### NOTE

- Do not clean in a dishwasher.
- If the rack becomes hard to remove or replace, lightly wipe the oven rack guides with cooking oil. Do not wipe cooking oil on the slides.
- If the rack becomes difficult to slide, the rack may need to be lubricated using a graphite lubricant.

#### NOTE

- To order graphite lubricant, call Samsung customer care at 1-800-SAMSUNG (726-7864) or visit our homepage ([www.samsung.com/us/support](http://www.samsung.com/us/support), [www.samsung.com/ca/support](http://www.samsung.com/ca/support), or [www.samsung.com/ca\\_fr/support](http://www.samsung.com/ca_fr/support)) and search for part number DG81-01629A.
- If you want to buy directly, go to <http://www.samsungparts.com>.

### To lubricate the slides of the gliding rack

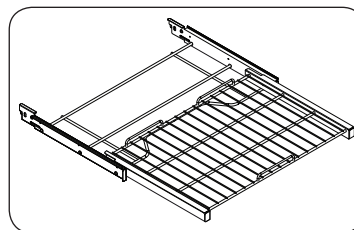

1. Remove the rack from the oven. See removing the gliding rack in the USING THE GLIDING RACK section.
2. Fully extend the rack on a table or countertop. Newspaper may be placed underneath the rack for easy cleanup.

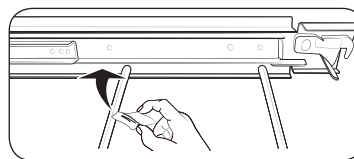

3. If there is debris in the slide tracks, wipe it away using a paper towel. (Any graphite lubricant wiped away must be replaced - See steps 4 through 7.)



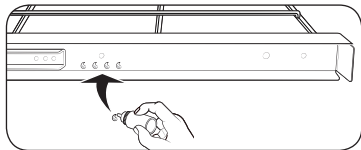

4. Shake the graphite lubricant before opening it. Starting with the left (front and back) slide mechanism of the rack, place four (4) small drops of lubricant on the two (2) bottom tracks of the slide close to the bearing carriers.

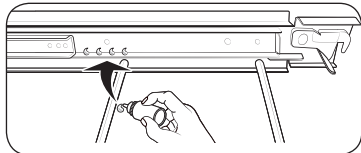

5. Repeat for the right (front and back) slide mechanism of the rack.
6. Open and close the rack several times to distribute the lubricant.
7. Replace the cap on the lubricant and shake it again. Turn the rack over and repeat steps 3, 4, 5 and 6.
8. Close the rack, turn the rack right-side-up, and then place in the oven. See installing the gliding rack in USING THE GLIDING RACK on page 24.

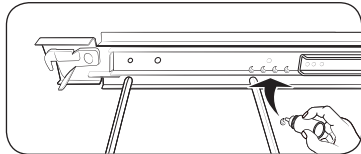

 **NOTE**

- Do not spray the gliding rack with cooking spray or other lubricant sprays.

### Oven door

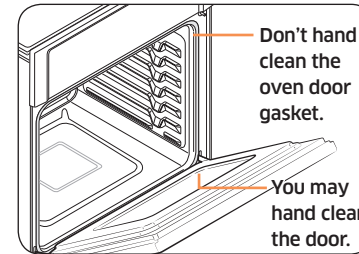

- Use soap and water to thoroughly clean the top, sides, and front of the oven door. Rinse well. You may use a glass cleaner on the outside glass of the oven door. **DO NOT** immerse the door in water. **DO NOT spray or allow water or the glass cleaner to enter the door vents.** **DO NOT** use oven cleaners, cleaning powders, or any harsh abrasive cleaning materials on the outside of the oven door.
- **DO NOT clean the oven door gasket.** The oven door gasket is made of a woven material which is essential for a good seal. Care should be taken not to rub, damage, or remove this gasket.

# Maintaining your appliance

## Removing the oven doors

### ⚠ CAUTION

- The door is very heavy. Be careful when removing and lifting the door.
- Do not lift the door by the handle.  
Use two hands to remove an oven door. For double ovens, repeat the process for each door.

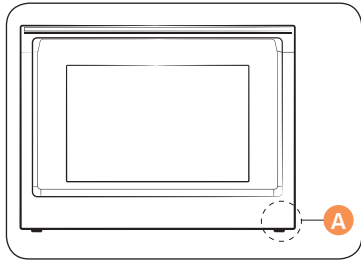

A. Wire Harness

1. Prior to removing the oven door, prepare a surface where you will place it. This surface should be flat and covered with a soft blanket. You can also use the corner posts from your packaging material.
2. Remove the rubber and disconnect the LED light's Wire Harness from the bottom right of the door.

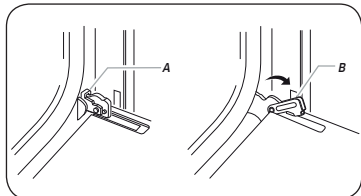

- A. Oven door hinge lock in locked position  
B. Oven door hinge lock in unlocked position

3. Open the oven door.
4. Locate the oven door hinge locks in both corners of the oven door, and then rotate the hinge locks toward the oven door to the unlocked position. If the door hinge lock is not rotated fully (see illustration B on the left for an example of full rotation), you will not be able to remove the door properly.

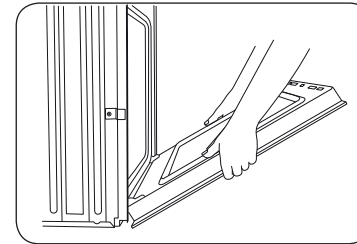

5. Partially close the door to engage the door latch locks.  
The door will stop at this point.

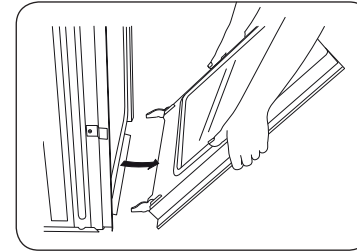

6. Using two hands, grasp the edges of the oven door. Lift and pull the oven door toward you and remove. You may need to gently shift the door from side to side as you pull.
7. Set the oven door aside on the prepared covered work surface with the oven door resting on its handle.

## Replacing the oven doors

### ⚠ CAUTION

The door is very heavy. You may need help lifting the door high enough to slide it into the hinge slots. Do not lift the door by the handle.

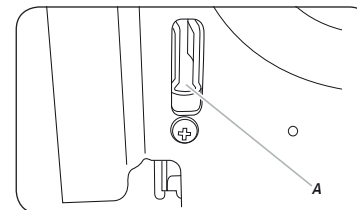

A. Slot in the oven cavity for the door hinge lock

1. Using two hands, grasp the side edges of the door at the midpoint. Face the oven cavity.
2. Locate the slots on each side of the oven cavity for the door hinge locks.

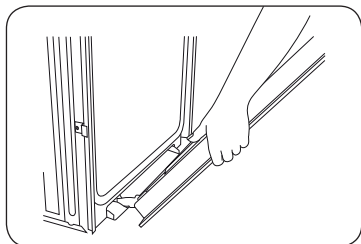

3. Hold the door at a 45° angle, and then align the door hinges with the slots in the lower front of the oven cavity. Slowly insert the door, making sure you maintain the 45° angle. You will know the door is engaged in the slot when you feel a slight drop.

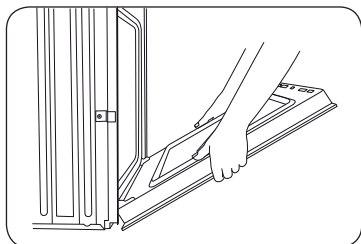

4. Lower the oven door to the fully open position. If the oven door does not open to a full 90°, repeat steps 1 through 3.
5. Locate the oven door hinge locks in the corners of the oven door, and rotate the hinge locks toward the oven cavity to the locked position.  
See Step 3 (illustration A) in the “Removing the oven doors” section for the proper locked position.
6. Close the oven door.
7. When the hinges are properly installed and the door is closed, there should be an even gap between the door and the control panel. If one side of the oven door is hanging lower than the other, the hinge on that side is not properly installed.
8. Reconnect the LED light’s Wire Harness and re-insert the rubber.

#### CAUTION

After replacing the door, make sure to reconnect the wires. Push them inward to arrange them as they were before you removed the door. Wires that are not connected or arranged correctly can be caught in the door or damaged by heat

## Changing the oven light

The oven light is a standard 40-watt appliance halogen bulb. It comes on when the oven door is open. When the oven door is closed, touch  to turn the light on or off. It will not work during a self-cleaning or Hybrid Cleaning cycle.

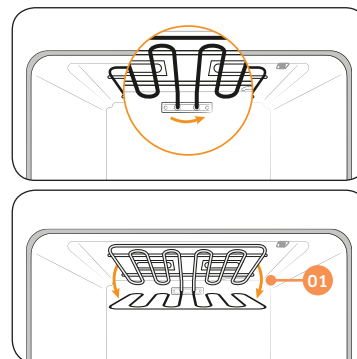

1. To change the halogen bulb, you must tilt the broil heater down. To do this, turn the circular nut on the support counterclockwise while holding the broil heater. The broil heater should loosen and tilt down.

**Important:** The broil heater is not a removable part. Do not force the broil heater down. Do not let it drop down.

2. Remove the glass cover.
3. Remove the halogen bulb cover.
4. Replace the halogen bulb.
5. When done, replace the halogen bulb cover, replace the glass cover, and then follow Step 1 above in the reverse order to return the broiler to its correct position.

#### CAUTION

Before changing your oven light, disconnect the electrical power to the oven at the main fuse or circuit breaker panel. Make sure the oven and the halogen bulb are cool.

# Troubleshooting

## Troubleshooting

Samsung works hard to ensure that you don't have problems with your new electric oven. If you run into unexpected trouble, look first for a solution in the tables below. If you're still having trouble after trying the suggested solution, call Samsung at 1-800-SAMSUNG (1-800-726-7864).

### CONTROL DISPLAY

Problem	Possible cause	Solution
The display goes blank.	A fuse in your home may be blown or the circuit breaker tripped.	Replace the fuse or reset the circuit breaker.
The buttons cannot be pressed properly.	<ul style="list-style-type: none"> <li>There is foreign matter caught between the buttons</li> <li>Touch model: There is moisture on the exterior</li> <li>The lock function is set</li> </ul>	<ul style="list-style-type: none"> <li>Remove the foreign matter and try again.</li> <li>Remove the moisture and try again.</li> <li>Check whether the lock function is set.</li> </ul>

### OVEN

Problem	Possible cause	Solution
The oven will not turn on.	The oven is not completely plugged into the electrical outlet.	Make sure the electrical plug is inserted into a live, properly grounded outlet.
	A fuse in your home may be blown or a circuit breaker may have tripped.	Replace the fuse or reset the circuit breaker.
	The oven controls have been set improperly.	See the chapter on operating the oven starting on page 19.
	The oven is too hot.	Allow the oven to cool.
	Incomplete service wiring.	Call for service.
The oven light will not turn on.	Power outage.	Check to see if the house lights will turn on. If necessary, call your local electric company for service.
	The light is loose or defective.	<ul style="list-style-type: none"> <li>Tighten or replace the lamp.</li> <li>Call for service if the door light does not turn on.</li> </ul>
	The switch operating the light is broken.	Call for service.

Problem	Possible cause	Solution
The oven smokes excessively during broiling.	The oven controls have not been set properly.	Refer to the section on operating the oven on page 28.
	The meat has been placed too close to the element.	Reposition the rack to provide proper clearance between the meat and the element. Preheat the broil element for searing.
	The meat has not been properly prepared.	Remove excess fat from the meat. Cut away fatty edges that may curl, leaving the lean intact.
	Grease has built up on oven surfaces.	Regular cleaning is necessary when broiling frequently.
Food does not bake or roast properly.	The oven controls have not been set correctly.	See the chapter on operating the oven starting on page 19.
	The oven rack has been positioned incorrectly or is not level.	See the section on using the oven racks on page 23.
	Incorrect cookware or cookware of improper size is being used.	
	The oven thermistor needs to be adjusted.	See the Temp Adjust section on page 33.

Problem	Possible cause	Solution
Food does not broil properly.	The serving size may not be appropriate.	Refer to the broiling recommendation guide for serving sizes on page 28, and then try again.
	The rack has not been properly positioned.	See the broiling recommendation guide on page 28.
	The cookware is not suited for broiling.	Use suitable cookware.
	In some areas, the power (voltage) may be low.	<ul style="list-style-type: none"> <li>Preheat the broil element for 10 minutes.</li> <li>See the broiling recommendation guide on page 28.</li> </ul>
The oven temperature is too hot or too cold.	The oven sensor needs to be adjusted.	See the section on adjusting the thermostat on page 33.
There is water dripping.	You may see water or steam in some cases depending on the food you are cooking. This is not a product malfunction.	Let the oven cool and then wipe with a dry dish towel.
There is steam coming through the crack between the oven body and the door.		
Water is remaining in the oven.		

# Troubleshooting

Problem	Possible cause	Solution
I can hear water boiling during steam cooking.	Water is being heated by the steam heater.	This is not a product malfunction.
The oven will not self-clean.	The oven temperature is too high to start a self-clean operation.	Allow the oven to cool and then reset the controls.
	The oven controls have been set incorrectly.	See the section on self-cleaning on page 35.
	A self-cleaning cycle cannot be started if the oven lockout feature has been activated.	Deactivate the oven lockout (see page 35).
Excessive smoking during a self-cleaning cycle.	There is excessive soiling in the oven.	Touch <b>OVEN OFF</b> . Open the windows to rid the room of smoke. Wait until the self-cleaning cycle is cancelled. Wipe up the excessive soil and then start the self-cleaning cycle again.
The oven door will not open after a self-cleaning cycle.	The oven is too hot.	Allow the oven to cool.
The oven is not clean after a self-cleaning cycle.	The oven controls were not set correctly.	See the section on self-cleaning on page 35.
	The oven was heavily soiled.	Wipe up heavy spillovers before starting the self-cleaning cycle. Heavily soiled ovens may need to be self-cleaned again or for a longer period of time.

Problem	Possible cause	Solution
Steam is coming out of the vent.	When using the convection feature, it is normal to see steam coming out of the oven vent.	This is normal operation and not a system failure. Use the oven as usual.
	As the number of racks or amount of food being cooked increases, the amount of visible steam will increase.	
A burning or oily odor is coming from the vent.	This is normal for a new oven and will disappear in time.	<ul style="list-style-type: none"> <li>To speed the process, set a self-cleaning cycle for a minimum of 3 hours.</li> <li>See the section on self-cleaning on page 35.</li> </ul>
Strong odor.	An odor coming from the insulation around the inside of the oven is normal for the first few times the oven is used.	Operate the oven empty on the bake setting at 400 °F for 1 hour.
Fan noise.	A convection fan may automatically turn on and off.	This is not a system failure but normal operation.
The oven racks are difficult to slide.	The shiny, silver-colored racks were cleaned in a self-cleaning cycle.	Apply a small amount of vegetable oil to a paper towel, and then wipe the edges of the oven racks with the paper towel.
The oven door is locked.	The circuit breaker has been tripped or there was a power failure while the oven door was locked.	Activate Control Lockout, and then unlock the control. See the Control Lockout section on page 21.

## Information codes

### OVEN

Displayed Code	Possible cause	Solution
C-d0	This code occurs if the control key is short for 1 minute.	Clean the buttons and make sure there is no water on/ around them. Turn off the oven and try again. If the problem continues, contact a local Samsung service center.
C-d1	This code occurs if the door lock is mispositioned.	Touch <b>OVEN OFF</b> , and then restart the oven. If the problem persists, disconnect all power to the oven for at least 30 seconds and then reconnect the power. If this does not solve the problem, call for service.
C-F0	This code occurs if communication between the Main and Sub PBA is interrupted.	
C-F2	This code occurs if communication between the Main and Touch is interrupted.	
C-20	The oven sensor is open when the oven is operating.	
	The oven sensor is short when the oven is operating.	

Displayed Code	Possible cause	Solution
C-21	This code occurs if the internal temperature rises abnormally high.	Touch <b>OVEN OFF</b> , and then restart the oven. If the problem persists, disconnect all power to the oven for at least 30 seconds and then reconnect the power. If this does not solve the problem, call for service.
C-23	The temp probe sensor is short when the oven is operating.	
C-30	The PCB sensor is open when the oven is operating.	Call for service
	The PCB sensor is short when the oven is operating.	
C-31	This code occurs if the PCB temperature rises abnormally high.	Call for service
C-70	The Steam sensor is open when the oven is operating.	Touch <b>OVEN OFF</b> , and then restart the oven. If the problem persists, disconnect all power to the oven for at least 30 seconds and then reconnect the power. If this does not solve the problem, call for service.
	The Steam sensor is short when the oven is operating.	
C-72	There are drain system-related problems.	Call for service.
C-A2	Cooling motor is abnormally operated.	Call for service.

# Warranty (U.S.A)

**PLEASE DO NOT DISCARD. THIS PAGE REPLACES THE WARRANTY PAGE IN THE USE & CARE GUIDE**

## SAMSUNG ELECTRIC OVEN

### LIMITED WARRANTY TO ORIGINAL PURCHASER

This SAMSUNG brand product, as supplied and distributed by SAMSUNG ELECTRONICS AMERICA, INC. (SAMSUNG) and delivered new, in the original carton to the original consumer purchaser, is warranted by SAMSUNG against manufacturing defects in materials and workmanship for a limited warranty period of:

#### One (1) Year Parts and Labor

This limited warranty begins on the original date of purchase, and is valid only on products purchased and used in the United States. To receive warranty service, the purchaser must contact SAMSUNG for problem determination and service procedures. Warranty service can only be performed by a SAMSUNG authorized service center. The original dated bill of sale must be presented upon request as proof of purchase to SAMSUNG or SAMSUNG's authorized service center. Samsung will provide in-home service during the warranty period at no charge subject to availability within the contiguous United States. In home service is not available in all areas. To receive in home service, the product must be unobstructed and accessible to the service agent. If service is not available Samsung may elect to provide transportation of the product to and from an authorized service center. SAMSUNG will repair or replace this product, at our option and at no charge as stipulated herein, with new or reconditioned parts or products if found to be defective during the limited warranty period specified above. All replaced parts and products become the property of SAMSUNG and must be returned to SAMSUNG. Replacement parts and products assume the remaining original warranty, or ninety (90) days, whichever is longer.

This limited warranty covers manufacturing defects in materials and workmanship encountered in normal, noncommercial use of this product and shall not apply to the following: damage which occurs in shipment; delivery and installation; applications and uses for which this product was not intended; altered product or serial numbers; cosmetic damage or exterior finish; accidents, abuse, neglect, fire, water, lightning or other acts of nature; use of products, equipment, systems, utilities, services, parts, supplies, accessories, applications, installations, repairs, external wiring or connectors not supplied or authorized by SAMSUNG which damage this product or result in service problems; incorrect electrical line voltage, fluctuations and surges; customer adjustments and failure to follow operating instructions, maintenance and environmental instructions that are covered and prescribed in the instruction book; product removal and reinstallation; problems caused by pest infestations, and overheating or overcooking by user. This limited warranty shall not cover cases of incorrect electric current, voltage or supply, light bulbs, house fuses, house wiring, cost of a service call for instructions, or fixing installation errors. SAMSUNG does not warrant uninterrupted or error-free operation of the product.



EXCEPT AS SET FORTH HEREIN THERE ARE NO WARRANTIES ON THIS PRODUCT EITHER EXPRESS OR IMPLIED AND SAMSUNG DISCLAIMS ALL WARRANTIES INCLUDING, BUT NOT LIMITED TO, ANY IMPLIED WARRANTIES OF MERCHANTABILITY, INFRINGEMENT OR FITNESS FOR A PARTICULAR PURPOSE. NO WARRANTY OR GUARANTY GIVEN BY ANY PERSON, FIRM OR CORPORATION WITH RESPECT TO THIS PRODUCT SHALL BE BINDING ON SAMSUNG. SAMSUNG SHALL NOT BE LIABLE FOR LOSS OF REVENUE OR PROFITS, FAILURE TO REALIZE SAVINGS OR OTHER BENEFITS, OR ANY OTHER SPECIAL, INCIDENTAL OR CONSEQUENTIAL DAMAGES CAUSED BY THE USE, MISUSE OR INABILITY TO USE THIS PRODUCT, REGARDLESS OF THE LEGAL THEORY ON WHICH THE CLAIM IS BASED, AND EVEN IF SAMSUNG HAS BEEN ADVISED OF THE POSSIBILITY OF SUCH DAMAGES. NOR SHALL RECOVERY OF ANY KIND AGAINST SAMSUNG BE GREATER IN AMOUNT THAN THE PURCHASE PRICE OF THE PRODUCT SOLD BY SAMSUNG AND CAUSING THE ALLEGED DAMAGE. WITHOUT LIMITING THE FOREGOING, PURCHASER ASSUMES ALL RISK AND LIABILITY FOR LOSS, DAMAGE OR INJURY TO PURCHASER AND PURCHASER'S PROPERTY AND TO OTHERS AND THEIR PROPERTY ARISING OUT OF THE USE, MISUSE OR INABILITY TO USE THIS PRODUCT. THIS LIMITED WARRANTY SHALL NOT EXTEND TO ANYONE OTHER THAN THE ORIGINAL PURCHASER OF THIS PRODUCT, IS NONTRANSFERABLE AND STATES YOUR EXCLUSIVE REMEDY.

Some provinces or territories may or may not allow limitations on how long an implied warranty lasts, or the exclusion or limitation of incidental or consequential damages, so the above limitations or exclusions may not apply to you. This warranty gives you specific legal rights, and you may also have other rights which vary from state to state. User Replaceable Parts may be sent to the customer for unit repair. If necessary, a Service Engineer can be dispatched to perform service.

To obtain warranty service, please contact SAMSUNG at:

**Samsung Electronics America, Inc.  
85 Challenger Road Ridgefield Park, NJ 07660  
1-800-SAMSUNG (726-7864) and [www.samsung.com/us/support](http://www.samsung.com/us/support)**

## Warranty (CANADA)

**PLEASE DO NOT DISCARD. THIS PAGE REPLACES THE WARRANTY PAGE IN THE USE & CARE GUIDE**

### SAMSUNG ELECTRIC OVEN

#### LIMITED WARRANTY TO ORIGINAL PURCHASER

This SAMSUNG brand product, as supplied and distributed by SAMSUNG ELECTRONICS CANADA, INC. (SAMSUNG) and delivered new, in the original carton to the original consumer purchaser, is warranted by SAMSUNG against manufacturing defects in materials and workmanship for a limited warranty period of:

#### One (1) Year Parts and Labor

This limited warranty begins on the original date of purchase, and is valid only on products purchased and used in the CANADA. To receive warranty service, the purchaser must contact SAMSUNG for problem determination and service procedures. Warranty service can only be performed by a SAMSUNG authorized service center. The original dated bill of sale must be presented upon request as proof of purchase to SAMSUNG or SAMSUNG's authorized service center. Samsung will provide in-home service during the warranty period at no charge subject to availability within the contiguous CANADA. In home service is not available in all areas. To receive in home service, the product must be unobstructed and accessible to the service agent. If service is not available Samsung may elect to provide transportation of the product to and from an authorized service center.

## Warranty (CANADA)

SAMSUNG will repair or replace this product, at our option and at no charge as stipulated herein, with new or reconditioned parts or products if found to be defective during the limited warranty period specified above. All replaced parts and products become the property of SAMSUNG and must be returned to SAMSUNG. Replacement parts and products assume the remaining original warranty, or ninety (90) days, whichever is longer. This limited warranty covers manufacturing defects in materials and workmanship encountered in normal, noncommercial use of this product and shall not apply to the following: damage which occurs in shipment; delivery and installation; applications and uses for which this product was not intended; altered product or serial numbers; cosmetic damage or exterior finish; accidents, abuse, neglect, fire, water, lightning or other acts of nature; use of products, equipment, systems, utilities, services, parts, supplies, accessories, applications, installations, repairs, external wiring or connectors not supplied or authorized by SAMSUNG which damage this product or result in service problems; incorrect electrical line voltage, fluctuations and surges; customer adjustments and failure to follow operating instructions, maintenance and environmental instructions that are covered and prescribed in the instruction book; product removal and reinstallation; problems caused by pest infestations, and overheating or overcooking by user. This limited warranty shall not cover cases of incorrect electric current, voltage or supply, light bulbs, house fuses, house wiring, cost of a service call for instructions, or fixing installation errors. SAMSUNG does not warrant uninterrupted or error-free operation of the product.

EXCEPT AS SET FORTH HEREIN THERE ARE NO WARRANTIES ON THIS PRODUCT EITHER EXPRESS OR IMPLIED AND SAMSUNG DISCLAIMS ALL WARRANTIES INCLUDING, BUT NOT LIMITED TO, ANY IMPLIED WARRANTIES OF MERCHANTABILITY, INFRINGEMENT OR FITNESS FOR A PARTICULAR PURPOSE. NO WARRANTY OR GUARANTY GIVEN BY ANY PERSON, FIRM OR CORPORATION WITH RESPECT TO THIS PRODUCT SHALL BE BINDING ON SAMSUNG. SAMSUNG SHALL NOT BE LIABLE FOR LOSS OF REVENUE OR PROFITS, FAILURE TO REALIZE SAVINGS OR OTHER BENEFITS, OR ANY OTHER SPECIAL, INCIDENTAL OR CONSEQUENTIAL DAMAGES CAUSED BY THE USE, MISUSE OR INABILITY TO USE THIS PRODUCT, REGARDLESS OF THE LEGAL THEORY ON WHICH THE CLAIM IS BASED, AND EVEN IF SAMSUNG HAS BEEN ADVISED OF THE POSSIBILITY OF SUCH DAMAGES. NOR SHALL RECOVERY OF ANY KIND AGAINST SAMSUNG BE GREATER IN AMOUNT THAN THE PURCHASE PRICE OF THE PRODUCT SOLD BY SAMSUNG AND CAUSING THE ALLEGED DAMAGE. WITHOUT LIMITING THE FOREGOING, PURCHASER ASSUMES ALL RISK AND LIABILITY FOR LOSS, DAMAGE OR INJURY TO PURCHASER AND PURCHASER'S PROPERTY AND TO OTHERS AND THEIR PROPERTY ARISING OUT OF THE USE, MISUSE OR INABILITY TO USE THIS PRODUCT. THIS LIMITED WARRANTY SHALL NOT EXTEND TO ANYONE OTHER THAN THE ORIGINAL PURCHASER OF THIS PRODUCT, IS NONTRANSFERABLE AND STATES YOUR EXCLUSIVE REMEDY.

Some states do not allow limitations on how long an implied warranty lasts, or the exclusion or limitation of incidental or consequential damages, so the above limitations or exclusions may not apply to you. This warranty gives you specific legal rights, and you may also have other rights which vary from state to state.

To obtain warranty service, please contact SAMSUNG at:

**Samsung Electronics Canada Inc.**  
**2050 Derry Road West, Mississauga, Ontario L5N 0B9 Canada**  
**1-800-SAMSUNG (726-7864) and [www.samsung.com/ca/support](http://www.samsung.com/ca/support) (English)**  
**[www.samsung.com/ca\\_fr/support](http://www.samsung.com/ca_fr/support) (French)**

# Memo

## Open Source Announcement

The software included in this product contains open source software. You may obtain the complete corresponding source code for a period of three years after the last shipment of this product by sending an email to <mailto:oss.request@samsung.com>.

It is also possible to obtain the complete corresponding source code in a physical medium such as a CD-ROM; a minimal charge will be required.

The following URL <http://opensource.samsung.com/opensource/SimpleConnectTP/seq/0> leads to the download page of the source code made available and open source license information as related to this product. This offer is valid to anyone in receipt of this information.





Scan this with your smartphone

Scan the QR code\* or visit  
[www.samsung.com/spsn](http://www.samsung.com/spsn)  
to view our helpful  
How-to Videos and Live Shows

\* Requires reader to be installed on your  
smartphone

Please be advised that the Samsung warranty does NOT cover service calls to explain product operation, correct improper installation, or perform normal cleaning or maintenance.

#### QUESTIONS OR COMMENTS?

COUNTRY	CALL	OR VISIT US ONLINE AT
U.S.A Consumer Electronics	1-800-SAMSUNG (726-7864)	<a href="http://www.samsung.com/us/support">www.samsung.com/us/support</a>
CANADA	1-800-SAMSUNG (726-7864)	<a href="http://www.samsung.com/ca/support">www.samsung.com/ca/support</a> (English) <a href="http://www.samsung.com/ca_fr/support">www.samsung.com/ca_fr/support</a> (French)



DG68-00854A-00