

VISION GRILLS™ Vision Hybrid

KAMADO S-SERIES HYBRID



OWNER'S MANUAL

Model # S-4C1D1-H
S-CR4C1D1-H
S-W4C1D1-H

S-04C1D1-H
S-T4C1D1-H

Vision Grills, LLC
1531 Fairview, Suite B, St. Louis,
MO 63132 • 877.917.4273
www.visiongrills.com



ENGLISH

SAFETY INFORMATION

PLEASE READ THE ENTIRE MANUAL BEFORE OPERATING YOUR VISION KAMADO GRILL. PLEASE KEEP THIS MANUAL FOR FUTURE REFERENCE.

ATTENTION! Use caution when cooking as grill surfaces get hot. To avoid burns, always use protective gloves to adjust top and bottom vents when grill is in use. Do not wear loose clothing near the grill.

ATTENTION! This barbecue will become very hot, do not move it during operation. For outdoor cooking use only. Do not operate grill indoors or in an enclosed space. Use grill only in well ventilated area around the grill free from combustible materials. Allow for at least 3 feet/.1 meter of clearance around grill (house, other outdoor products, hanging tree limbs, shrubs, etc.).

WARNING! Keep children and pets away from the grill at all times. Do not allow children to operate grill. Never leave grill unattended when in use.

Grill needs to be placed securely on a level base prior to use. Only operate grill on a hard, stable level surface (concrete patio, ground, etc.) capable of supporting the grill's weight when loaded with food. Never operate grill on wood support surface, wood deck or like combustible support surfaces under any conditions. Never attempt to move grill when in operation or cooling down. Never operate this grill within 25 feet/7.5 meters of any flammable liquid. Never operate this grill within 10 feet/3 meters of a gas cylinder. The grill should not be placed under combustible structures, such as garage, porch, patio, or carport. Burning charcoal or propane gives off carbon monoxide, which has no odor and can cause death.

The use of alcohol, prescription or non-prescription drugs may impair the operator's ability to properly assemble or safely operate the grill. Do not use on boats or recreational vehicles.

CAUTION: Never use lighter fluid, gasoline, or other volatiles to start your charcoal, as they are dangerous and leave a residual taste in your food. Use only firelighters complying to EN 1860-3. Use utmost care when adding charcoal to grill. Electric start-up is recommended. Dispose of cooled ashes by placing them in aluminum foil, soaking with water and discarding in a non-combustible container.

When operating with gas, top vent **MUST** be open at all times, see instructions.

GENERAL INSTRUCTIONS

This instruction manual contains important information necessary for the proper assembly and safe use of the appliance. Read and follow all warnings and instructions before assembling and using the appliance. Keep this manual for future reference.

⚠ DANGER

If you smell gas:

- **Shut off gas to the appliance.**
- **Extinguish any open flame.**
- **Open lid.**
- **If odor continues, keep away from the appliance and immediately call your fire department.**

⚠ WARNING

- **Do not store or use gasoline or other flammable liquids or vapors in the vicinity of this or any other appliance.**
- **Any LP cylinder not connected for use shall not be stored in the vicinity of this or any other appliance.**

- 1) The installation conforms with the National Fuel Gas Code, ANSI Z223.1/NFPA 54, Natural Gas and Propane Installation Code, CSA B149.1; or Propane Storage and Handling Code, B149.2.
- 2) This outdoor cooking gas appliance shall be used only outdoors and shall not be used in a building, garage or any other enclosed area.
- 3) This outdoor cooking gas appliance is not intended to be installed in or on boats and not intended to be installed in or on recreational vehicles.

GENERAL INSTRUCTIONS

(CONTINUED)

- 4) Minimum clearance from sides and back of unit to combustible construction, 32" from sides and 32" from back. And the outdoor cooking gas appliance shall not be used under overhead combustible surfaces.
- 5) Please inspect the hose before each use of the outdoor cooking gas appliance. If it is evident there is excessive abrasion or wear, or the hose is cut, it must be replaced prior to the outdoor cooking gas appliance being put into operation. The replacement hose assembly shall be that specified by the manufacturer.
- 6) Lighting Instruction
 - (a) Read the instructions before lighting.
 - (b) Confirm that the control knob is in the "OFF" position.
 - (c) Open lid during lighting.
 - (d) Open the gas tank valve knob.
 - (e) Push in the control knob and turn counter clockwise until you hear click, hold for 6 seconds, observe the fire, then adjust to the desired setting.
 - (f) If ignition does not occur within 5 seconds, turn the burner control(s) off, wait 5 minutes, and repeat the lighting procedure.
- 7) Note
 - (a) Keep outdoor cooking gas appliance area clear and free from combustible materials, gasoline and other flammable vapors and liquids.
 - (b) Do Not obstruct the flow of combustion and ventilation air.
 - (c) Keep the ventilation opening(s) of the cylinder enclosure free and clear from debris.
 - (d) Visually check burner flames including pilot burner flame.
 - (e) Clean outdoor cooking gas appliance, including special surfaces, with recommended cleaning agents, if necessary.
 - (f) Check and clean burner/venturi tubes for insects and insect nests. A clogged tube can lead to a fire beneath the grill.
- 8) If parts are missing, contact Vision Grills at (877)917-4273 or contact Vision Grills via e-mail at help@visiongrills.com or through the website at www.visiongrills.com.
- 9) The cylinder diameter is 12", the total height is 18" and volume is 20 lbs.
- 10) The LP gas supply cylinder(s) to be used must be constructed and marked:
 - (a) In accordance with the Specifications for LP-Gas Cylinders of the U.S. Department of Transportation (D.O.T.) or the National Standard of Canada, CAN/CSA-B339, Cylinders, Spheres and Tubes for Transportation of Dangerous Goods; and Commission, as applicable.
 - (b) Provided with a listed overfilling prevention device.
 - (c) Provided with a cylinder connection device compatible with the connection for outdoor cooking appliance.
- 11) If the outdoor cooking gas appliance is not in use, the gas must be turned off at the supply cylinder. Storage of an outdoor cooking gas appliance indoors is permissible only if the cylinder is disconnected and removed from the outdoor cooking gas appliance. Cylinders must be stored outdoors out of the reach of children and must not be stored in a building, garage or any other enclosed area.
- 12) The pressure regulator and hose assembly supplied with the outdoor cooking gas appliance must be used. If pressure regulator and hose assembly are missing or need to be replaced, contact Vision Grills at (877)917-4273 or contact Vision Grills via e-mail at help@visiongrills.com or through the website at www.visiongrills.com.
- 13) The cylinder used must include a collar to protect the cylinder valve.
- 14) (a) Do not store a spare LP-gas cylinder under or near this appliance;
 - (b) Never fill the cylinder beyond 80 percent full; and
 - (c) If the information in "14-(a)" and "14-(b)" is not followed exactly, a fire causing death or serious injury may occur.
- 15) Place dust cap on cylinder valve outlet whenever the cylinder is not in use. Only install the type of dust cap on the cylinder valve outlet that is provided with the cylinder valve. Other types of caps or plugs may result in leakage of propane.

COMPONENTS

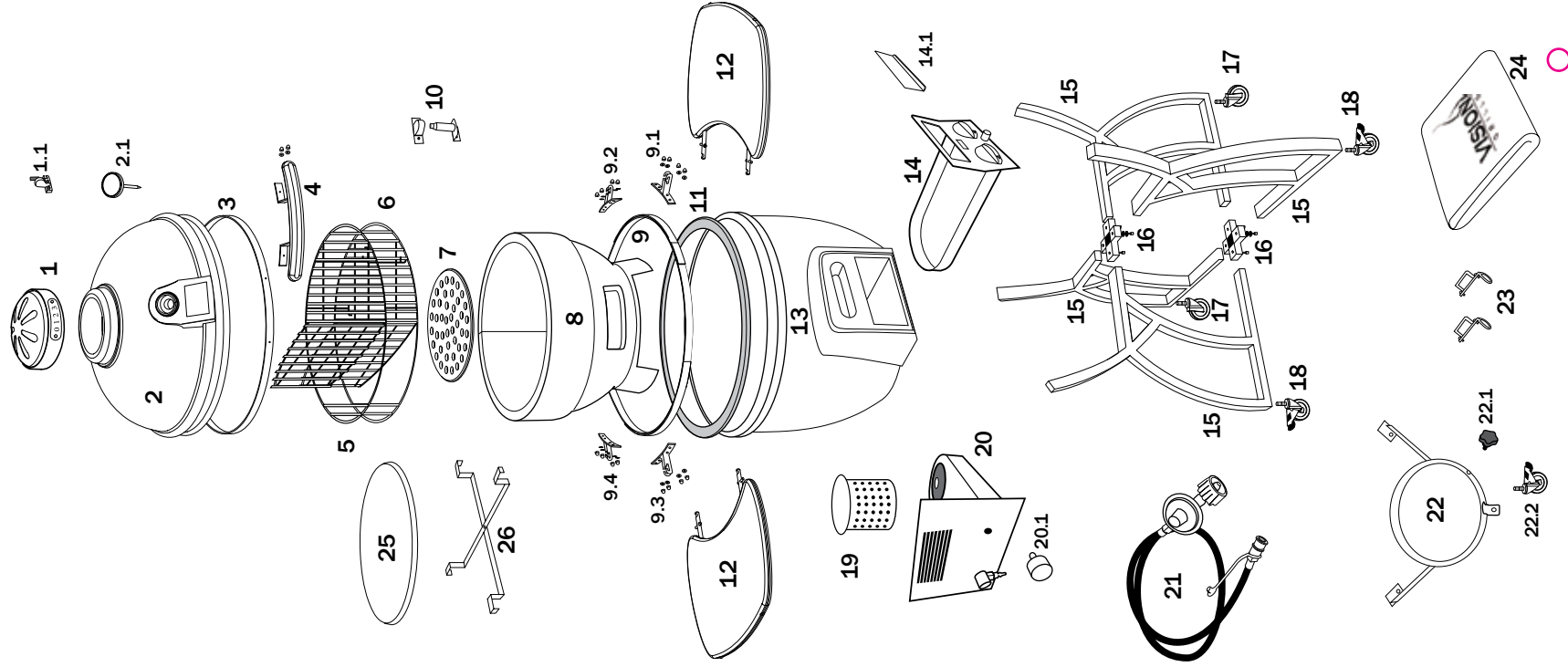

COMPONENT LIST

PART NAMES	PART NUMBERS
1 Cast Iron Top Vent	VGC TV-CA-SP
1.1 Bakelite Tab with Stopper Pin	VGC TV-CA-TSP
2 Ceramic Dome Lid	VGC CDL-2
2.1 Thermometer	VGC IT
3 Top Ring Assembly	VGC RA1-L
4 Handle (with nuts & washers)	VGC HDL-L
5 Top Cooking Grate	VGC CGT-L
6 Bottom Cooking Grate	VGC CGB-L
7 Charcoal Grate	VGC CG-L
8 Fire Bowl	VGC FB-1
9 Bottom Ring Assembly	VGC RA2
9.1 Right Front Side Shelf Bracket (with nuts & washers)	VGC SB-RF
9.2 Right Back Side Shelf Bracket (with nuts & washers)	VGC SB-RB
9.3 Left Front Side Shelf Bracket (with nuts & washers)	VGC SB-LF-L
9.4 Left Back Side Shelf Bracket (with nuts & washers)	VGC SB-LB-L
10 Shock Absorber Assembly	VGC AC-L
11 Felt Gasket	VGC FLT-L
12 Wood Shelves (x2)	VGC WS-RR
13 Ceramic Dome Bottom	VGKP CDB-S
14 Ash Drawer Body	VGC ADS-PC
14.1 Bottom Draft Door Frame	VGC ADB-PCFD-L
15 Cart Leg (x4)	VGC CLEG-PC
16 "X" Leg Connectors (with bolts, washers & spring washers)	VGC XLC-L
17 Rubber Wheels (x2) Standard	VGC WHLS-L
18 Rubber Wheels (x2) Locking	VGC WHL-L-L
19 Infrared Heat Exchanger	VGC GPIHE
20 Gas Grill Burner Insert	VGC GPBI-S
20.1 Gas Grill Burner Insert Knob	VGC GPBIK
21 Gas Supply Line w/ Regulator	VGC GPSLR
22 Gas Tank Caddy	VGC GPTC-SS
22.1 Gas Tank Caddy Knob	VGC GPTCK
22.2 Gas Tank Caddy Rubber Wheel	VGC GPCWHL
23 Gas Supply Hose Bracket (x2)	VGC GPGSLC-2
24 Grill Cover	VGC GC-L
25 Lava Stone	VGK-101R
26 SS Stone Bracket	VGK-BRACKET

WELCOME TO VERSATILE KAMADO COOKING

Your new Vision Grills Kamado Hybrid is the complete outdoor cooking appliance that allows you to sear, grill, bake and smoke all types of food with your choice of Charcoal or Gas.

For best results with charcoal, we recommend using natural lump charcoal made from hardwoods. Compared to briquettes, natural charcoals start faster, burn cleaner and longer, reach higher temperatures and produce less ash. Left over natural charcoal also relights for re-use. Before restarting the grill, knock off excess ashes to any remaining charcoal. Routinely empty ashes, but only do so when grill is cold.

For those times you want to quickly prepare a meal without the use of charcoal, you have the Quickchange Gas Insert to help you. Simply pull out the removable Ash Drawer and slide in the Gas Insert, position the Heat Exchanger and fire it up!

Welcome to the new the newest innovation for versatile Kamado cooking! Before beginning, make sure to read the following Manual completely for instructions on operating with **CHARCOAL** or **GAS**.

VISION  **GRILLS™** **Vision**Hybrid 



STARTING CHARCOAL

Switching from Gas Insert

WARNING: Grill, Gas Insert, Heat Exchanger, Charcoal Grate(s), Lava Stone and Brackets must be cooled before removal.

- 1) Close the gas tank valve and the gas hose that connects the Gas Insert. The gas must be turned to “CLOSED” position at the gas cylinder.
- 2) Remove Heat Exchanger from top of Gas Insert.
- 3) Lift and pull Gas Insert from front of grill.
- 4) Store Gas Tank, Hose, Gas Insert and Heat Exchanger in cool, dry place, out of the elements.

Note: Do not store the Gas Cylinder in Gas Tank Caddy when cooking with charcoal.

Step 1: Measuring Charcoal

Set bottom vents wide open and open lid. Replace cast iron charcoal grate in bottom of fire bowl. Measure out the amount of charcoal needed. For grilling, fill the fire bowl with enough charcoal to just cover the air holes. For smoking foods at low temperatures for longer periods of time (1.5 hours+) you will need to add a little more charcoal, up to approximately 2” (50 mm) above the same air holes. Use lump charcoal for best results.

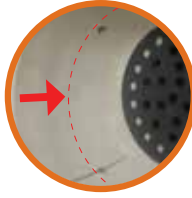

Charcoal Fill Level

Step 2: Starting Charcoal

Open the electric starter flipper door and insert starter as far as possible then plug in.

Wait until edges of charcoal turn white and flames are licking the mound of charcoal. On average, it takes 8 - 12 minutes to start the charcoal.



Electric Starter sold separately on some models.

Step 3: Setting Temperature

When charcoal is ready, level it out for even heat distribution. Close the lid. Set the top and bottom vents to the desired setting by referring to the Setting Temperature section in this manual that tells what number calibrations to use to attain the cooking temperature you want. Give your kamado 5-15 minutes to settle into the cooking temperature you want before you put food on the grill.

NOTE: If smoking, do not bring your temperature up above 300°F/150°C.

- A) Spread hot charcoal evenly over grate.
- B) Set top and bottom vents for cooking.
- C) Let temperature stabilize.

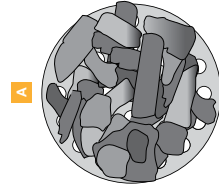

Top Vent

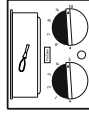

Bottom Vent
Control Knobs









Step 4: Get Cooking

Do not cook until the charcoal has a coating of ash. Use a wire grill brush to clean the cooking grate. That's it - you are ready for the cooking experience of your life. Go to www.visiongrills.com for recipes.

Step 5: Ash Removal

Always let the ashes cool before removing. Prior to each use, lift and pull out Removable Ash Drawer and dispose of ash.

CHARCOAL SETTING TEMPERATURE

	TOP VENT		BOTTOM VENT
SEARING		500°F 260°C	 5 - 10
GRILLING		300° - 450°F 149° - 233°C	 5 - 7
SMOKING		225° - 250°F 107° - 221°C	 1/2 - ●●

Vision Kamado Grills cooking temperatures are controlled by adjusting the calibrated top and bottom vents.

*Caution - Decide if you're cooking low and slow, then do not let the grill get too hot. Keep the temperature low, it takes hours to cool down.

Increasing air flow through top and bottom air vents increases cooking temperature, just as decreasing air flow slows the burn and lowers the cooking temperature. Closing both top and bottom vents starves the charcoal of oxygen and shuts down the fire.

*Caution - Continuous grilling at extreme high temperatures will cause the felt gasket to burn.

Prevent Flare-Ups:

If the lid is lifted too quickly, oxygen will rush inside the grill causing a flare-up. To prevent a flare up, lift the lid 1" / 25mm and count to three before fully opening the grill.

VISION GRILLS™

VisionHybrid



STARTING GAS INSERT

ATTENTION: The grill needs to be cooled before switching from the ProZone to the Gas Insert.

Step 1: Lock Top Vent

Turn Top Vent to position 3. Turn locking pin counter clockwise until it drops down in place, keeping the Top Vent fully open.

WARNING: When using Gas Insert, Top Vent must be locked open to position 3 at all times.



Step 2: Remove ProZone

Remove Cooking Grates and Charcoal Grate. Sweep all excess charcoal and ash into Ash Drawer of ProZone. Pull out ProZone and empty ash from drawer and store in a cool, dry place.



Step 3: Insert Gas Insert

Slide Gas Insert into grill opening in the base of the grill until it stops and locks into place.



Step 4: Position Heat Exchanger

Install the stainless steel infrared Heat Exchanger on top of Gas Insert. Allow 2 bottom stems of Heat Exchanger to drop into into the slots on top of the Gas Insert.



Step 5: Place Heat Diffuser Lava Stone

Spread bracket so it makes an "X" shape and lower onto fire bowl, allowing the bracket to rest on edge of bowl. Lower Lava Stone onto the bracket. Replace cooking grates with hinged sections facing towards front of grill.



Step 6: Connect to Gas Tank

Using the Quick Connect fitting on the Gas Supply Hose, pull back spring-loaded locking ring and slide over male connection. Once it has snapped into place, give slight tug on gas line to ensure that it is securely connected. Turn valve on gas tank to Open position.

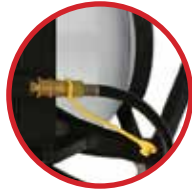

Step 7: Ignite Gas Insert

Use leak test* to ensure there are no leaks. Open grill lid.

Push in the Control Knob on the Gas Insert and turn counter clockwise until you hear a click then hold for 6 seconds as starter ignites. Observe fire is lit in Heat Exchanger. Close grill lid and observe grill thermometer and adjust to desired temperature by adjusting Control Knob.

If ignition does not occur within 5 seconds, turn the Control Knob to OFF position. Wait 5 minutes and repeat the lighting procedure.



***Leak Test:** Pour Leak Test Solution (not included) or soapy water at the connection spot of the gas cylinder to check whether there is air leakage. If solution produces bubbles this means there is a leak.

Watch For Bubbles



GAS INSERT SETTING TEMPERATURE

Lock Top Vent

Turn Cast Iron Top Vent to position 3. Turn locking pin counter clockwise until it drops down in place, keeping the Top Vent fully open.



WARNING: When using Quickchange Gas Insert, Top Vent must be locked open to position 3 at all times.

SEARING

400° – 600°F
200° – 340°C

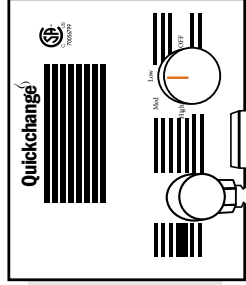

GRILLING

300° – 400°F
150° – 200°C

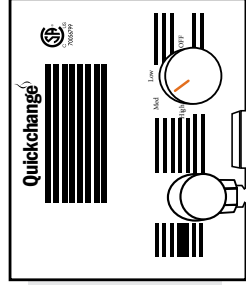

SMOKING

175° – 225°F
80° – 110°C

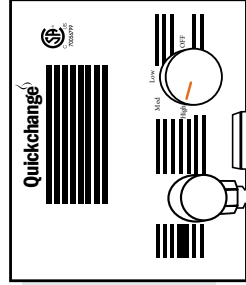

The VisionHybrid Kamado cooking temperatures are controlled by adjusting the burner knob on the Gas Insert. Cooking times and temperatures will vary depending on your location.

*Caution – Decide if you're cooking low and slow, then do not let the grill get too hot. Keep the temperature low, it will take time to cool down.

*Caution - Continuous grilling at extreme high temperatures will cause the felt gasket to burn.

Prevent Flare-Ups:

If the lid is lifted too quickly, oxygen will rush inside the grill causing a flare-up. To prevent a flare up, lift the lid 1" / 25mm and count to three before fully opening the grill.

VISION GRILLS™

VisionHybrid

COOKING TEMPERATURE

All cooking times and temperatures are approximate. Visit foodsafety.gov for additional information on safe minimum cooking temperatures.

SMOKING

	Approximate Cooking Time	Smoker Temp (°F)	Meat Temp. (°F)
BEEF			
Brisket (8 - 12 lbs)	1.5 hours/lb	225 - 250	185 - 205
Short Ribs	5 hours	225 - 250	Pulls back from bones
Tenderloin (3 - 4 lbs)	1-4 hours	225 - 250	120 - 160
PORK			
Baby Back Ribs (1.5 - 2.5 lbs)	5 hours	225 - 250	Pulls back from bones
Butt (6 - 8 lbs)	1.5 hours/lb	225 - 250	170 - 205
Ham (Bone In)	1.5 hours/lb	225 - 250	160
Shoulder (6 - 10 lbs)	5 - 12 hours	225 - 250	170 - 205
Spare Ribs (2.5 - 3 lbs)	5 - 7 hours	225 - 250	Pulls back from bones
Tenderloin (1.5 - 2 lbs)	2.5 - 3 hours	225 - 250	160
POULTRY			
Turkey (Whole: 10 - 12 lbs)	5 - 6.5 hours	240 - 275	170
Chicken (Whole: 2.5 - 4.5 lbs)	2.5 - 4 hours	250 - 275	170

GRILLING (350 - 450°F)

	Beef Temp (°F)	Pork Temp (°F)
Rare	125 + 3 min. Rest	—
Medium-Rare	130 - 135	145 + 3 min. Rest
Medium	135 - 140	150
Medium-Well	140 - 150	155
Well-Done	155+	160+
Ground	160	
Poultry Temp (°F)		
Dark Meat	165 - 175	
White Meat	165	
Ground	170 - 175	

VISION GRILLS™ VisionHybrid

CHARCOAL & GAS INSERT

MAINTENANCE & TROUBLESHOOTING

- 1) After grill has cooled use a soft cloth to clean exterior of grill.
- 2) Clean the cooking grates before and after cooking.

Note: Remove surface dust and grease

- 3) Stainless steel heat deflector should be clean prior to each use.
 - a) Check out if there is debris in the heat exchanger.
 - b) When there is debris, please clean it with a stiff brush.
- 4) Clean Side Shelves with mild detergent.
- 5) When grill is cooled, use grill cover to prolong life of grill.
- 6) When the Gas Insert is not in use:
 - a) Ensure that the Control Knob is off.
 - b) Ensure that the valve on gas tank is turned to Closed position.
 - c) Ensure that there is not gas leakage from the gas hose.
- 7) Leak Detection Method
 - a) Inspect valve connections, port and regulator assembly.
 - b) Look for any damage or debris. Remove any debris.
 - c) Inspect hose for damage.
 - d) Turn gas cylinder knob clockwise to Open position.
 - e) Pour soapy water or Leak Test Solution (sold separately) at the connection spot of the gas cylinder to check whether there is gas leakage.

NOTE: Check whether bubbles appear. (If there are no bubbles, there is no air leakage; If bubbles appear, there is gas leakage.)

- f) Repeat Leak test at the connection spot at the gas entrance of the gas insert to check whether there is gas leakage.

Watch For Bubbles



- g) If you can not solve your problem by the above steps, or you have other problems that need help, please contact Vision Grills Customer Service at help@visiongrills.com or www.visiongrills.com.

Manual Ignition (Match Ignition) Method of Operation

1. Put match in the ignition tool as shown.



2. Light match, insert inside the front left opening as shown.



3. Slide in match to the inside back of the Gas Insert, reaching the burner. (Rear Side View shown)



4. Turn the knob to High and press it down until it is lit.



5. Light the gas and observe flame within the Heat Exchanger.



WARRANTY

Subject to the following terms and conditions, Phase 2, LLC, d/b/a Vision Grills (“Vision Grills”) warrants to the original purchaser that the ceramic cooker and gas insert manufactured or supplied by Vision Grills will be free from defects in material and workmanship under normal use for the following periods from the original date of purchase: limited lifetime for all ceramic parts, five (5) years for all metal parts, including burner, one (1) year for temperature gauge, gasket and cover, 90-days for side shelves, lava stone, quick disconnect, hose and regulator. This Limited Lifetime Warranty is contingent upon purchaser registering the product at www.visiongrills.com/register within 30 days from the date of purchase along with a copy of the original dated sales receipt which can be attached in an electronic format (i.e. scan, photograph, etc.) to your registration at www.visiongrills.com/register. Failure to do so will invalidate the warranty. Any chips or cracks in the finish of the ceramic cooker present at the time of purchase must be noted on the original dated sales receipt. This Warranty is not transferable to subsequent owners. If you cannot register online it will be necessary to contact Vision Grills customer service at (877) 917-4273 or email help@visiongrills.com.

If any product covered by this Warranty is defective due to a covered warranty condition, such product will, at the option of Vision Grills, be repaired to its original condition or replaced with a comparable new product or part. The repair and/or replacement of parts shall constitute the extent of the liability and obligations of Vision Grills under this Warranty. Purchaser is required to provide photographic evidence to assess the damage when submitting claim. Scratches, cracks, chips, dents, crazing, or minor cosmetic blemishes of the exterior glaze not affecting performance are not covered under warranty, as determined by Vision Grills.

This Warranty does not cover damages caused by improper assembly, improper care, failure to follow directions of use, misuse, abuse, negligence, extreme environmental conditions, normal wear and tear, accidents, acts of nature, or unauthorized repair, alteration or modification, as determined by Vision Grills. This Warranty does not apply to chips or cracks in the ceramic cooker which may occur after the ceramic cooker is purchased by the original purchaser. Vision Grills is not liable for any default or delay in its performance under this Warranty that is caused by any circumstances beyond its control. This Warranty will be invalidated if any liquids, including starter lighter fluid, are poured on or in the ceramic cooker. The protective coating of the ceramic cooker can be compromised by substances or conditions that are beyond Vision Grills’ control. While Vision Grills uses rust-resistant materials, the Warranty as to metal parts does not cover rust or oxidation unless the structural integrity of the ceramic cooker is compromised as determined by Vision Grills.

This Warranty does not cover purchases with unauthorized resellers and/or third parties. Warranty coverage is limited to products purchased at an authorized reseller only.

Commercial use and related applications are not covered under this Warranty. Warranty coverage is based on normal residential use and maintenance.

Vision Grills shall not be liable for any delay or default under this Warranty caused by any event or contingency beyond Vision Grills control. This includes acts of nature, fire, government restrictions or restraints, strikes, reduced supply of materials or transportation delays.

THIS WARRANTY IS THE EXCLUSIVE WARRANTY OF VISION GRILLS. VISION GRILLS EXPRESSLY DISCLAIMS ANY AND ALL OTHER WARRANTIES, EXPRESS OR IMPLIED, INCLUDING WARRANTIES OF FITNESS, MERCHANTABILITY, OR FITNESS FOR A PARTICULAR PURPOSE. THIS WARRANTY DOES NOT COVER, AND VISION GRILLS IS NOT LIABLE FOR, ANY DAMAGES RELATING TO LOSS OF TIME, LOSS OF USE OF EQUIPMENT, INCONVENIENCE, OR ANY INCIDENTAL, SPECIAL AND/OR CONSEQUENTIAL DAMAGES. PURCHASER’S EXCLUSIVE REMEDY FOR BREACH OF THIS WARRANTY SHALL BE LIMITED AS SPECIFIED HEREIN TO REPLACEMENT OR REPAIR OF THE AFFECTED PRODUCT.

Some states do not allow limitations on how long an implied warranty lasts or the exclusion or limitation of incidental or consequential damages, so the above limitations and exclusions may not apply to you. This Warranty gives you specific legal rights, and you may also have other rights which vary from state to state. Vision Grills does not authorize any person or entity to assume any obligation or liability on its behalf in connection with the sale and purchase of any of its products. The purchase of any Vision Grills product from anyone other than Vision Grills or an authorized dealer will void the Warranty associated with the product. If you have a question regarding the identity of an authorized dealer, you should contact Vision Grills before you purchase the product.

To submit a warranty claim, the original purchaser or authorized agent of the original purchaser must contact Vision Grills at (877) 917-4273 or contact Vision Grills via e-mail, help@visiongrills.com, or through the website at www.visiongrills.com.

VISION GRILLS™

VisionHybrid

WARNING

PLEASE READ THE ENTIRE MANUAL AND SETUP AND INSERT BEFORE OPERATING YOUR VISION KAMADO GRILL. PLEASE KEEP THIS MANUAL FOR FUTURE REFERENCE.

ATTENTION! Use caution when cooking as grill surfaces get hot. To avoid burns, always use protective gloves to adjust top and bottom vents when grill is in use. Do not wear loose clothing near the grill.

ATTENTION! This barbecue will become very hot, do not move it during operation. For outdoor cooking use only. Do not operate grill indoors or in an enclosed space. Use grill only in well-ventilated areas. Keep immediate area around the grill free from combustible materials. Allow for at least 3 feet/1 meter of clearance around grill (house, other outdoor products, hanging tree limbs, shrubs, etc.)

WARNING! Keep children and pets away from the grill at all times. Do not allow children to operate grill. Never leave grill unattended when in use.

Grill needs to be placed securely on a level base prior to use. Only operate grill on a hard, stable level surface (concrete patio, ground, etc.) capable of supporting the grill's weight when loaded with food. Never operate grill on wood support surface, wood deck or like combustible support surfaces under any conditions. Never attempt to move grill when in operation or cooling down. Never operate this grill within 25 feet/7.5 meters of any flammable liquid. Never operate this grill within 10 feet/3 meters of a stored gas cylinder. The grill should not be placed under combustible structures, such as garage, porch, patio, or carport. Burning charcoal and/or gas gives off carbon monoxide, which has no odor and can cause death.

The use of alcohol, prescription or non-prescription drugs may impair the operator's ability to properly assemble or safely operate the grill. Do not use on boats or recreational vehicles.

CAUTION: Never use lighter fluid, gasoline, or other volatiles to start your charcoal, as is dangerous and they leave a residual taste in your food. Use only firelighters complying to EN 1860-3. Use utmost care when adding charcoal to grill. Electric start-up is recommended for charcoal. Dispose of cooled ashes by placing them in aluminum foil, soaking with water and discarding in a non-combustible container. Always wait for grill to be completely cooled before opening built-in ash drawer.

When charcoal cooking above 500° F/260° C, with both top and bottom vents closed, rapidly opening the lid creates a sudden rush of oxygen into the grill, which can cause a flare-up of flames. When in this cooking mode, we recommend that, prior to opening the lid, you open both top and bottom vents to allow oxygen to stabilize inside the grill before opening, minimizing the possibility of flare-ups.

VISION GRILLS™

VisionHybrid