



Kitchen Cabinet

Installation Guide



The instructions given here serve as a general guideline on how to install frameless cabinets in a reasonably simple installation. Many cabinet designs and installations may be far more complex and beyond the scope of these instructions and require a professional installer.

- Tools Required
- Layout and Planning the Installation
- Cabinet Installation Order
- Installing Cabinets Level
- Fastening Cabinets to the Wall
- Fastening Cabinets Together
- Installing Fillers
- Installing Trim
- Adjusting Hinges and Drawers



Warning: Kitchen installations typically involve gas, high voltage wiring, plumbing and mechanical details like heating and AC vents. This guide only covers cabinet installation. At a minimum, if you're not well versed in these areas make sure that all power is shut off to exposed wiring and gas valves are closed to gas supply lines.

- Tools Required

• Tape Measure • Pencil • 3 to 4 foot Level • 3/16" Drill Bit • Phillips Head Screwdriver • #2 Square Drive Bit* • Electric Drill • Hammer • Wood Shims • Phillips Head Screw Gun • Handsaw • Chalk Line • Step Ladder • Extension Cord • Pry Bar • Clamps • Carpenter's Square • NOTE: If "C" clamps are used, protect material between finished case of the cabinet and the clamp.

- Additional tools that make the job easier:

Small Table saw • Power Miter Saw • Laser Level • Stud Finder

- **Layout and Planning the Installation**

1. Take inventory of the cabinets as per the plan or order.
2. Find the high spot in the floor using a level as shown below.

Locating the Highpoint on the Floor for a Wall

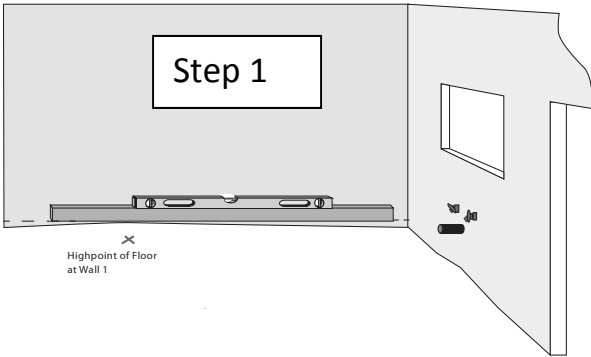

Locating the Highpoint on the Floor for an Adjacent Wall

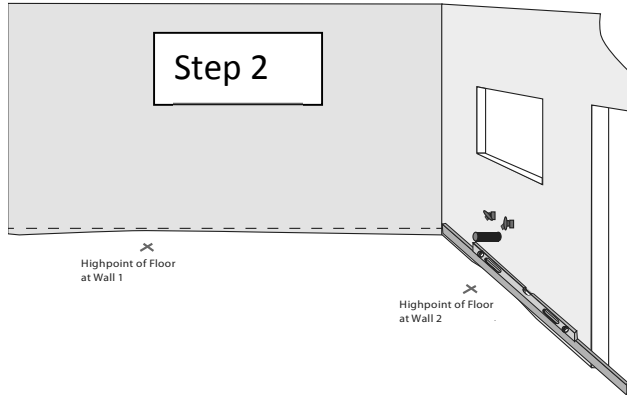

Locating the Highpoint on the Floor Between Two Walls

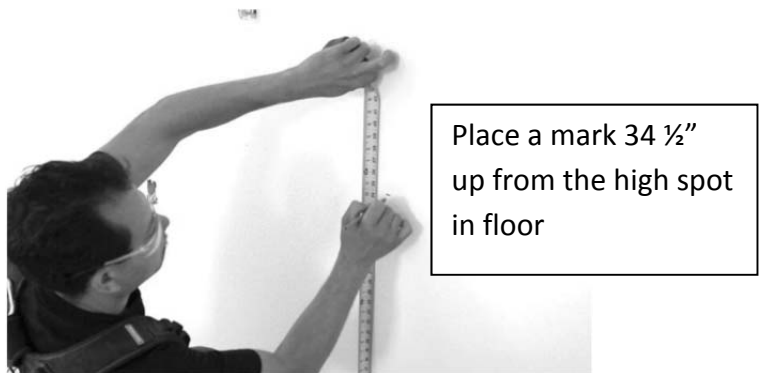
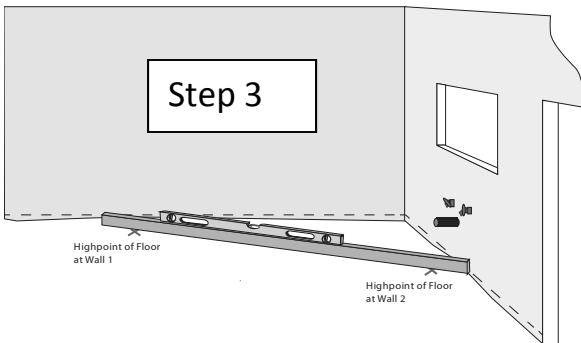

3. Measure up the wall 34 1/2" above the high spot and draw a level line anywhere that base cabinets will be installed. (This means that this line will measure greater than 34 1/2" above the floor in most places along the wall.)
4. Find and mark the studs. This can be done by trial and error of driving a nail in the wall until you find a stud or use an electronic stud finder. Studs will usually be every 16" center to center.



5. It is best when installing a larger kitchen to mark the cabinet positions and code (size) on the wall. Better to find out now if things aren't going to fit just right than after you've installed several cabinets.
6. Unbox the cabinets and be cautious not to drag them across the floor. Save some cardboard to rest the cabinets on to prevent damage to the cabinets and the floor.



7. Remove all doors, drawers and shelves, being careful to mark them so that they go back on correct cabinets. Removing the doors can be done without tools as the hinges are "clip-on".

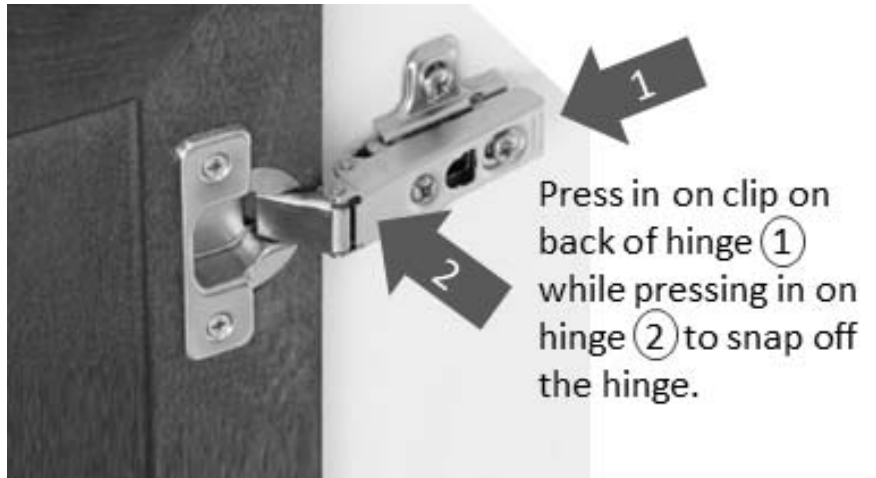

Removing drawer boxes are different depending on the type drawer.

Standard drawers can be removed by simply pulling the drawer out until it stops, then lift up the front of the drawer and remove the drawer.

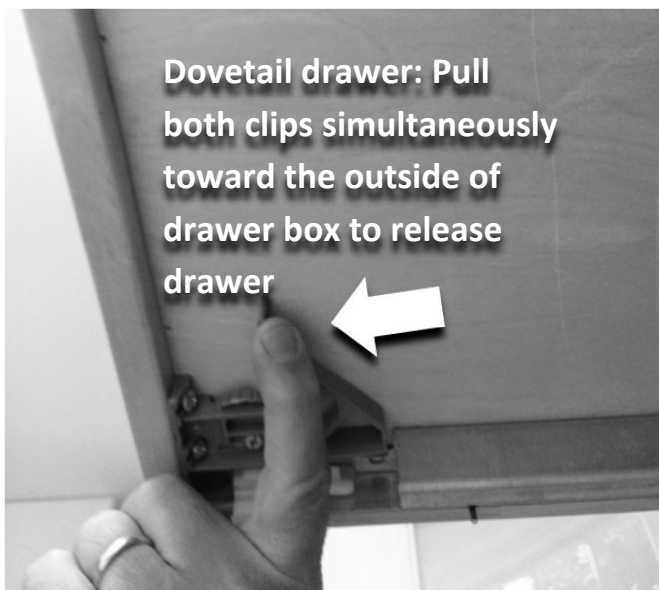

Dovetail drawers can be removed by pulling the drawer out until it stops. Then reach under the drawer box on both sides just behind the drawer front. Pull the clips holding both of them simultaneously while lifting up on the drawer box. Then slide the drawer out.

• Cabinet Installation Order

1. Determining the installation order of the cabinets depends on the plan. As a general rule it is better to start with wall cabinets in the corner and work out. However, if you have “tall” cabinets, like a pantry or oven cabinet in the plan, it is critical to make sure that the tall cabinet is used to determine the top alignment of wall cabinets.

Wall cabinets must align with tall cabinets

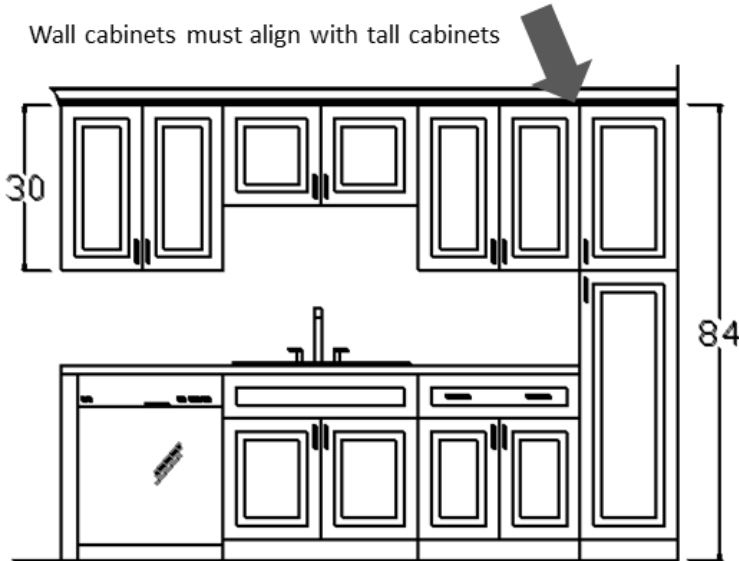

• Installing Cabinets Level

1. Nearly *every* floor, in *any* house, will *not* be level and flat. The illustrations below show an exaggerated view of why leveling cabinets to the high point in the floor is critical.

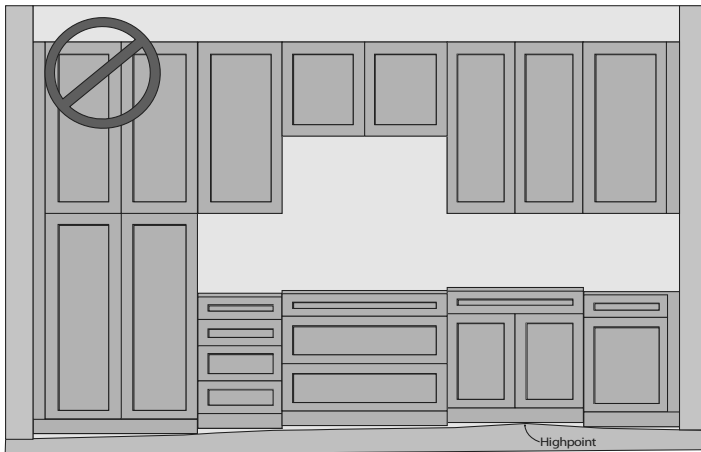

Wrong

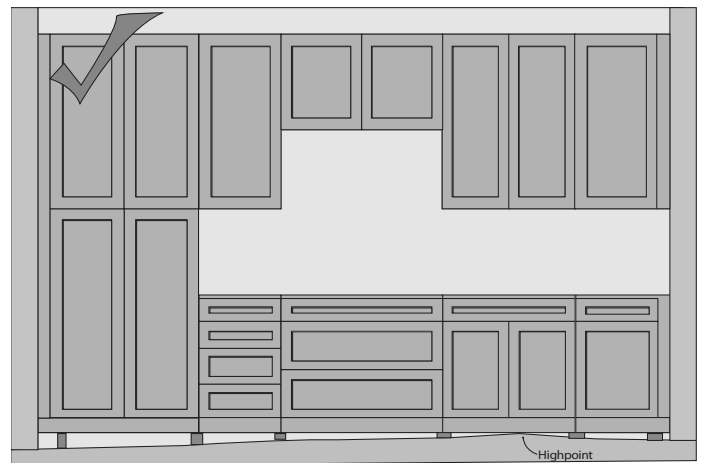

Right

2. Cabinets should be shimmed up from the floor level to the 34 ½" line with wood or composite shims.
3. Cabinets should also be shimmed out from the wall to maintain a straight line. Hampton Bay Designer Series cabinets are designed to be a “frameless construction” which means when the cabinets are screwed together they will be forced into a straight line regardless of how wavy or bowed the wall or surface they’re fastened to may be.

Correcting for a "Bowed In" or "Bellied" Wall Condition

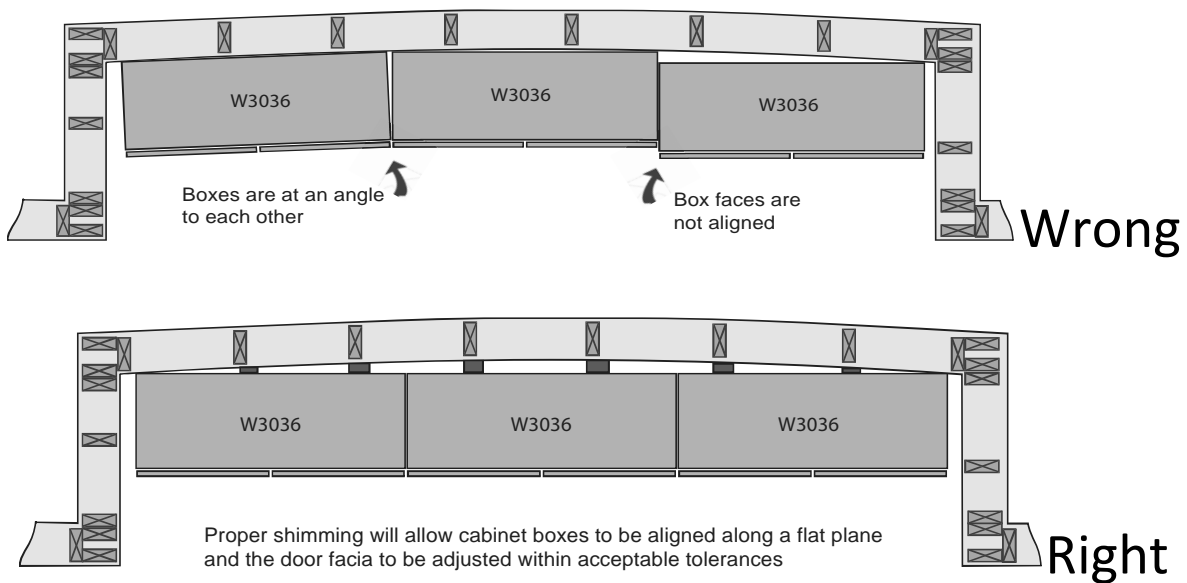

● Fastening Cabinets to the Wall

1. Screw wall cabinets and tall cabinets to the predetermined height through the back panel into a stud. Make sure to place screws 1" below the top and 1" above the bottom. Measure and mark the stud location on the cabinet before drilling. Use #8 x 2-1/2" flat head screws when fastening through a single layer of drywall into wood studs.
2. Place a screw at the top of the cabinet and the bottom of a cabinet in as many studs as can be located in the cabinet width.

Place screws 1" below the inside top of

Place screws 1" above the inside bottom of cabinet

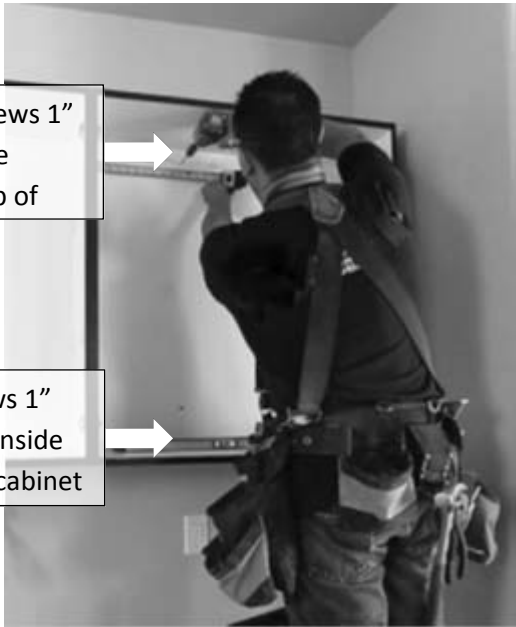

3. Level the cabinets.
4. Important: Make sure the cabinets are square by placing a framing square inside or outside of the cabinet. Frameless cabinets can be racked (or slightly twisted) before they are fastened in place.

- **Fastening Cabinets Together**

1. Align cabinet frames together carefully.



2. Cabinet cases can be clamped together using various kinds of clamps, however use caution with any kind of steel clamp to not damage the surface material of the cabinet.
3. Screw cabinets together with #7 x 1-1/8" flat head screws.

- **Installing fillers**

1. Cabinets come in 3" increments in width, therefore fillers will be required when cabinets are to fit between walls.



2. Measure the space between the wall and the cabinet at the top, middle and bottom. If the dimensions are close to the same you can rip (saw) the filler in a straight line to the proper width to fit.



3. Next, predrill holes for 1 1/4" screws and screw the fillers from the inside of the cabinet.

4. In a case where the wall is not plumb, the filler will have to be cut to fit to the uneven wall.

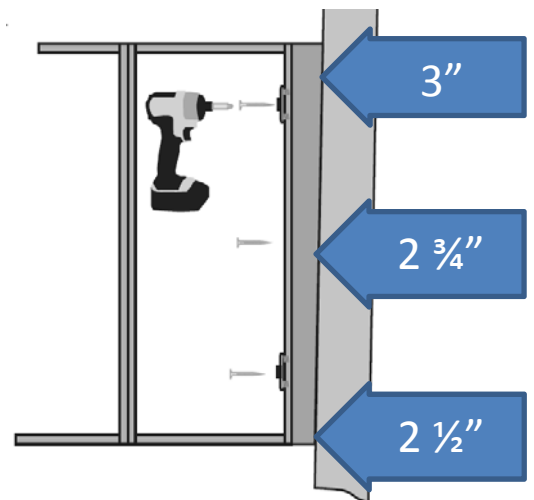

• Installing Trim

1. Installing crown molding can be accomplished in a variety of ways depending on the application. Using “frameless cabinets” means that a *sub-crown* molding will always have to be screwed to the top of the cabinet case to attach the crown molding to.

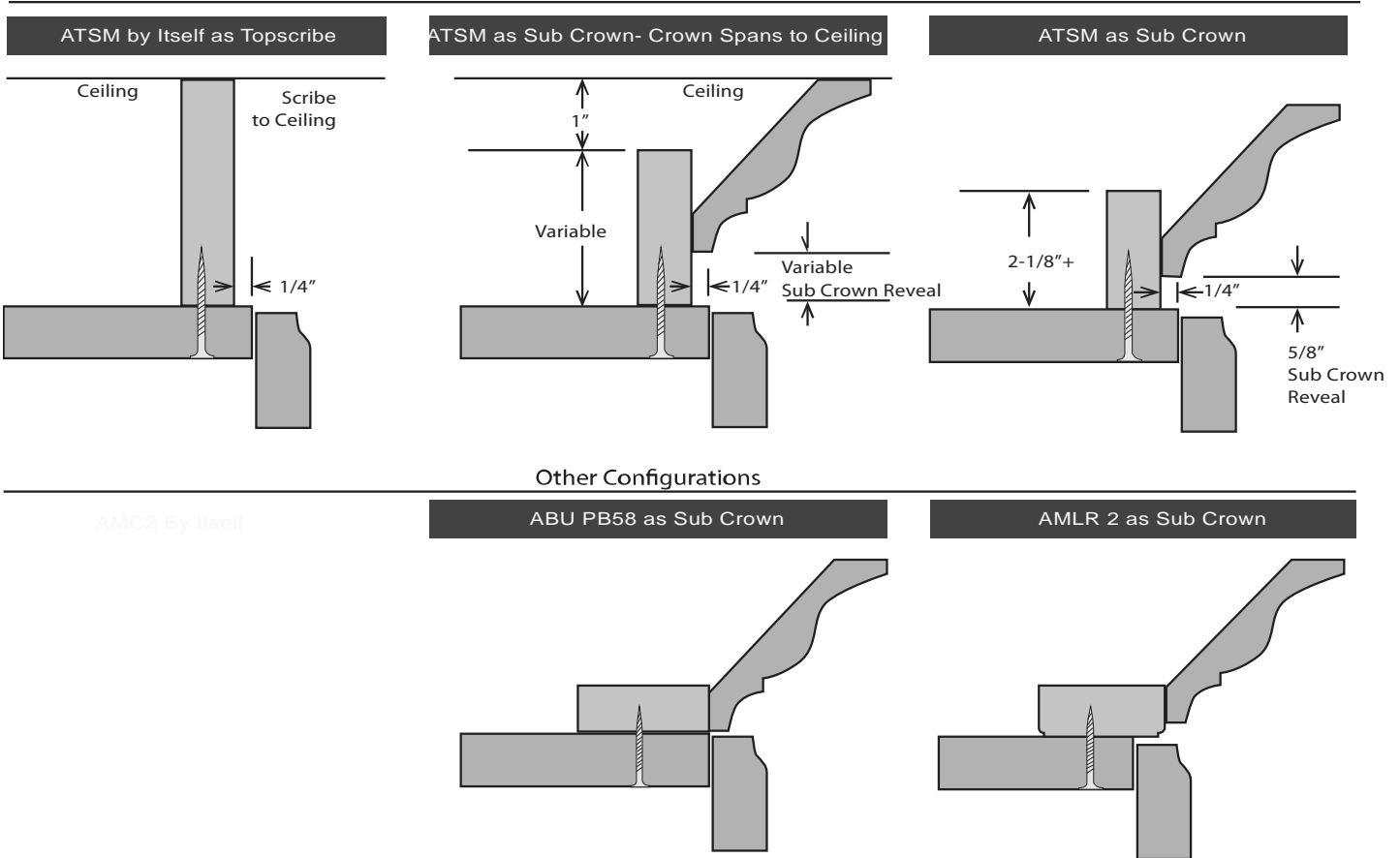

Light Rail In the same way, installing light rail will have to be screwed to the bottom of the case.

Light Rail Screw Placement

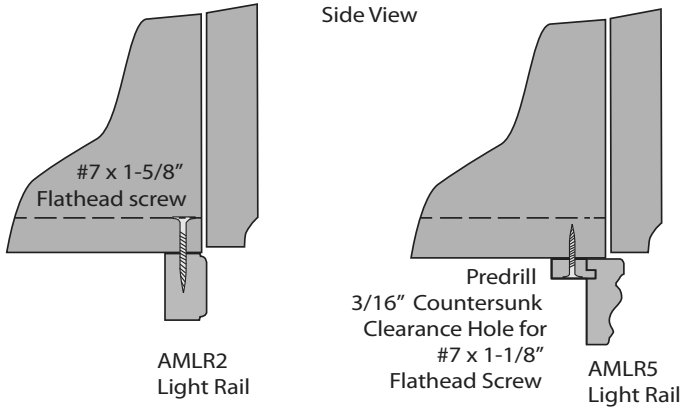

Light Rail Placement Examples AMLR2 and AMLR 5

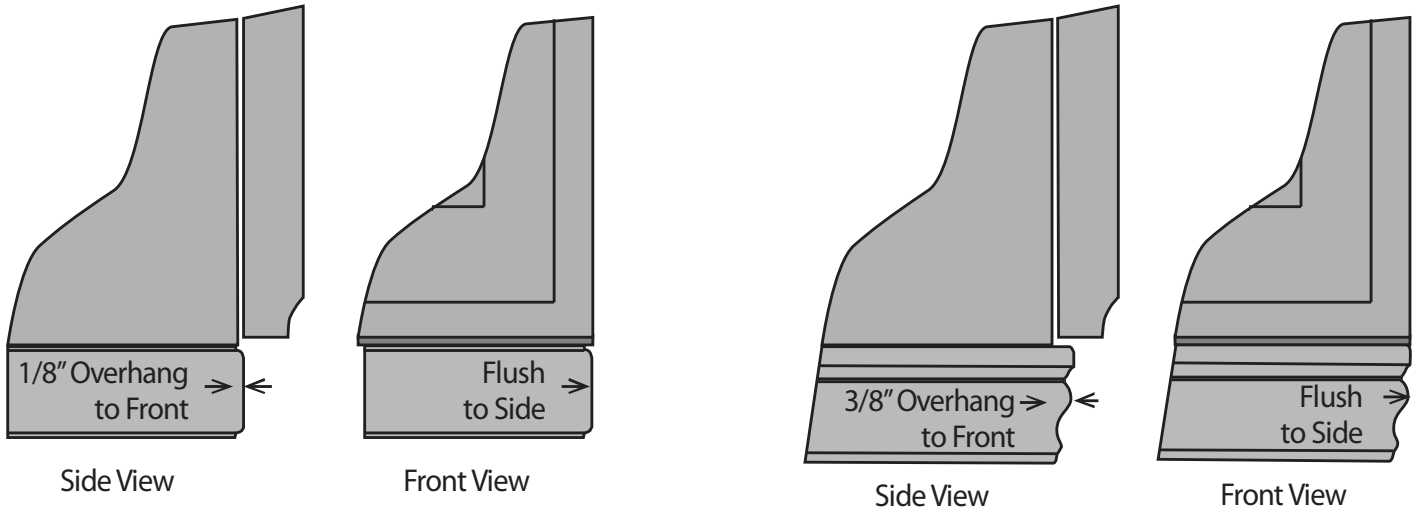

- Adjusting Doors and Drawers

Hinge Adjustment

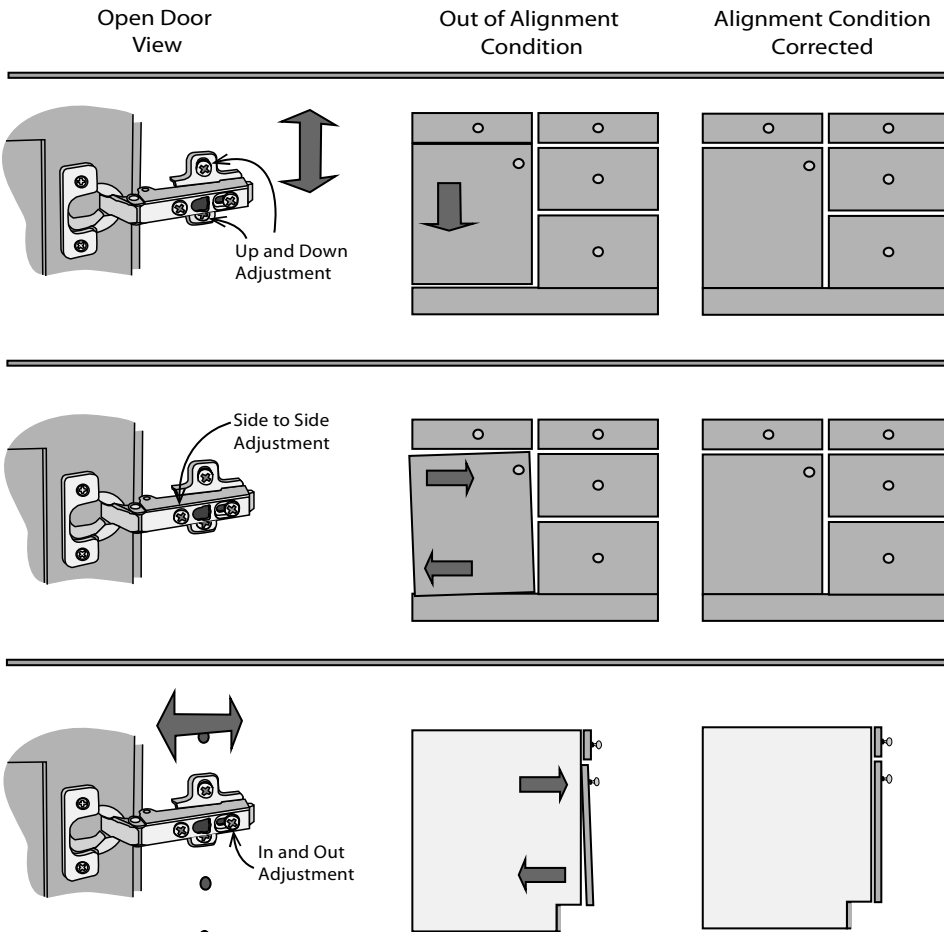

Hinge Removal and Reinstallation

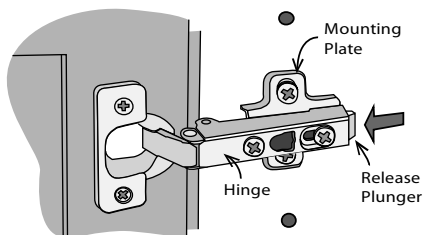

To Remove a Mounted Hinge:

Push the Release Plunger in from the Back of the Hinge

The Hinge Will Disengage from the Mounting Plate

To Remount a Hinge:

Align and Insert the Hinge Hooks into the Front of the Mounting Plate

Push the Back of the Hinge into the Plate Until it Clicks

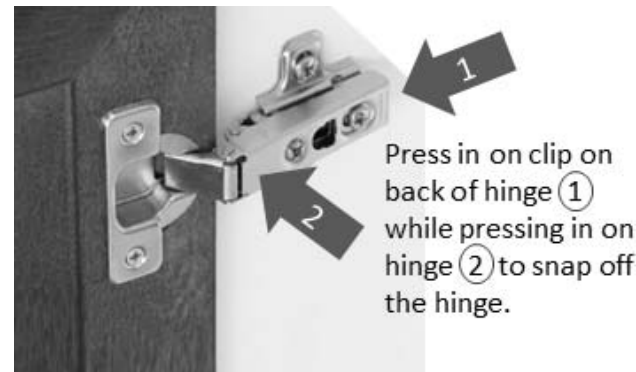
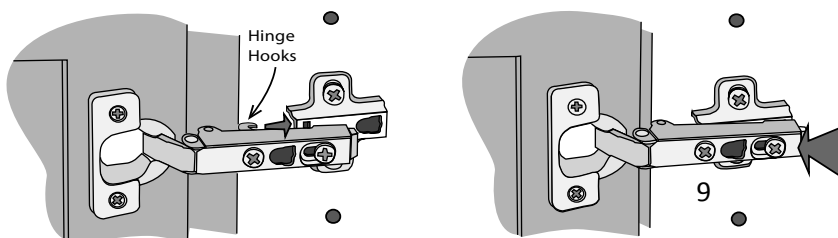

Drawer Adjustment

Standard Drawer

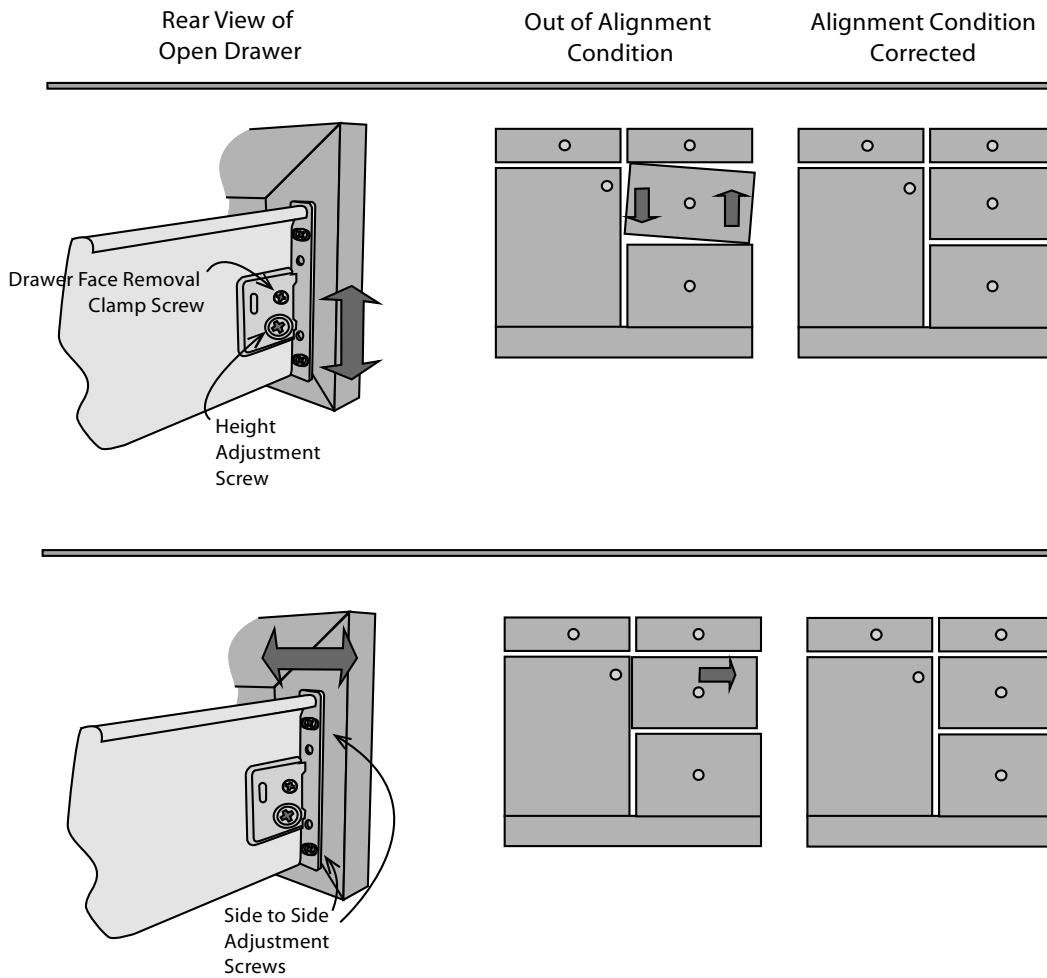

Dovetail Drawer Adjustment - To Adjust the dovetail drawer for alignment, slide the white plastic clip on the under side of the drawer back and forth to raise and lower the left and right side of the drawer.

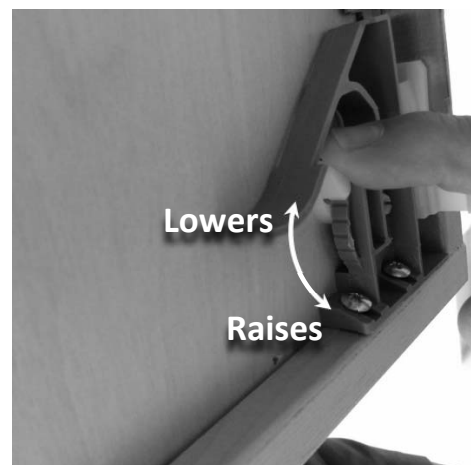
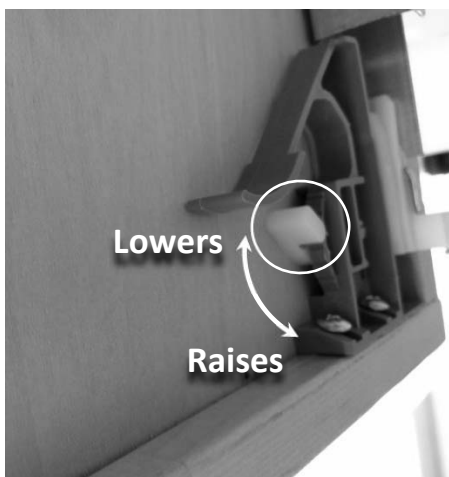



Limited Lifetime Warranty

This warranty covers substantial defects in materials and workmanship in your Hampton Bay Designers Series products under normal home use. This warranty is offered only to the original consumer purchaser and may not be transferred.

The coverage of this warranty lasts for the lifetime of the original purchaser, so long as he or she owns the home in which the product was first installed.

What This Warranty Covers: RSI Home Products, Inc. ("RSI") warrants its parts and products to be free of substantial defects in materials and workmanship from the original date of purchase under normal home use. This warranty is offered to the original consumer purchaser only and may not be transferred.

How Long The Warranty Lasts: Coverage for all Kitchen Cabinets and Accessories lasts for the life of the product.

What RSI Home Products Will Do Under The Warranty: During the warranty period, RSI, at its option, will repair or replace any part or product that proves to have substantial defects in materials or workmanship, or RSI will provide an equivalent replacement product. In keeping with our policy of continuous product improvement, RSI reserves the right to change specifications in design and materials without notice and with no obligation to retrofit products we previously manufactured.

How State Law Applies: This warranty gives you specific legal rights, and you may also have other rights that vary from state to state.

Implied Warranties: RSI disclaims any implied warranty of merchantability, and there are no warranties that extend beyond the descriptions on the face hereof. To the extent that such disclaimer is not valid under applicable law, any implied warranty shall be coextensive in duration with this warranty.

Wood, Aging And Printing Limitations: Because of the varying natural characteristics of wood and the effects of aging, product shown in displays and/or printed materials will not be an exact match to new cabinetry you will receive. Depending on the wood characteristics, the age of a sample and the environment of the showroom, samples will show some degree of variation from new product. In addition, you should not expect all doors, drawer fronts, trim or molding to match exactly in either finish or grain. Variation in wood is normal and unavoidable. In addition, it is not possible to match our colors exactly in printed materials. Therefore, you should view the actual samples when making your color selection.

What This Warranty Does Not Cover: This warranty does not cover any problems or damage which result from improper transportation, improper installation, mishandling, misuse, abuse, neglect, abnormal use, commercial use, improper maintenance, non-RSI repairs, accidents, or acts of God, such as hurricanes, fire, earthquakes or floods. This warranty, and any applicable implied warranties, does not cover incidental or consequential damages arising from any defects in the product, such as labor charges for installation or removal of the product or any associated products. This warranty does not cover defects or damage caused by normal wear and tear, alterations, environmental conditions, humidity absorption, or mold. In addition, variations in hand carved items, wood grain, finish color, aging or other natural wood and stain characteristics are not considered defects and are not covered by this warranty. Some states do not allow the exclusion or limitation of incidental or consequential damages, so the above limitation or exclusion may not apply to you.

Vendor Information

Email: HBDesignerseries@rsipcs.com

Address: 11350 Riverside Dr. Mira Loma, CA 91752

Customer Service #: 800-230-5661

Fax # for Order Processing: 844-554-0636