



OPERATOR'S MANUAL

MODEL #100403
1200W PORTABLE GENERATOR



REGISTER YOUR PRODUCT ONLINE

at championpowerequipment.com



READ AND SAVE THIS MANUAL. This manual contains important safety precautions which should be read and understood before operating the product. Failure to do so could result in serious injury. This manual should remain with the product.
Specifications, descriptions and illustrations in this manual are as accurate as known at the time of publication, but are subject to change without notice.
This product is rated in accordance with PGMA (Portable Generator Manufacturers' Association) standard PGMA G300 (Standard for Testing and Validating Performance of Portable Generators).

TABLE OF CONTENTS

<u>Introduction</u>	3	<u>Storage</u>	19
<u>Safety Definitions</u>	3	<u>Short Term Storage (up to 1 year)</u>	19
<u>Important Safety Instructions</u>	4	<u>Long Term Storage (over 1 year)</u>	20
<u>Fuel Safety</u>	6	<u>Removing from Storage</u>	20
<u>Safety Symbols</u>	7	<u>Specifications</u>	21
<u>Operation Symbols</u>	8	<u>Generator Specifications</u>	21
<u>Safety Labels</u>	9	<u>Engine Specifications</u>	21
<u>Controls and Features</u>	10	<u>Oil Specifications</u>	21
<u>Generator</u>	10	<u>Fuel Specifications</u>	21
<u>Control Panel</u>	11	<u>Spark Plug Specifications</u>	21
<u>Assembly</u>	12	<u>Valve Specifications</u>	21
<u>Unpacking</u>	12	<u>Temperature Specifications</u>	21
<u>Attach Vibration Mounts</u>	12	<u>Parts Diagram</u>	22
<u>Add Engine Oil</u>	12	<u>Parts List</u>	23
<u>Add Fuel</u>	13	<u>Engine Parts Diagram</u>	24
<u>Grounding</u>	14	<u>Engine Parts List</u>	25
<u>Operation</u>	14	<u>Wiring Diagram</u>	27
<u>Generator Location</u>	14	<u>Troubleshooting</u>	28
<u>Grounding*</u>	15		
<u>Surge Protection</u>	15		
<u>Starting the Engine</u>	15		
<u>Connecting Electrical Loads</u>	15		
<u>Do Not Overload Generator</u>	16		
<u>Stopping the Engine</u>	16		
<u>Maintenance</u>	17		
<u>Cleaning the Generator</u>	17		
<u>Changing the Engine Oil</u>	17		
<u>Cleaning and Adjusting the Spark Plug(s)</u>	17		
<u>Cleaning the Air Filter</u>	18		
<u>Cleaning the Spark Arrestor</u>	18		
<u>Adjusting the Governor</u>	18		
<u>Maintenance Schedule</u>	18		

INTRODUCTION

Congratulations on your purchase of a Champion Power Equipment (CPE) product. CPE designs, builds, and supports all of our products to strict specifications and guidelines. With proper product knowledge, safe use, and regular maintenance, this product should bring years of satisfying service.

Every effort has been made to ensure the accuracy and completeness of the information in this manual at the time of publication, and we reserve the right to change, alter and/or improve the product and this document at any time without prior notice.

Since CPE highly values how our products are designed, manufactured, operated and are serviced, and also highly value your safety and the safety of others, we would like you to take the time to review this product manual and other product materials thoroughly and be fully aware and knowledgeable of the assembly, operation, dangers and maintenance of the product before use. Fully familiarize yourself, and make sure others who plan on operating the product fully familiarize themselves too, with the proper safety and operation procedures before each use. Please always exercise common sense and always err on the side of caution when operating the product to ensure no accident, property damage, or injury occurs. We want you to continue to use and be satisfied with your CPE product for years to come.

When contacting CPE about parts and/or service, you will need to supply the complete model and serial numbers of your product. Transcribe the information found on your product's nameplate label to the table below

CPE TECHNICAL SUPPORT TEAM
1-877-338-0999
MODEL NUMBER
100403
SERIAL NUMBER
DATE OF PURCHASE
PURCHASE LOCATION

SAFETY DEFINITIONS

The purpose of safety symbols is to attract your attention to possible dangers. The safety symbols, and their explanations, deserve your careful attention and understanding. The safety warnings do not by themselves eliminate any danger. The instructions or warnings they give are not substitutes for proper accident prevention measures.

DANGER

DANGER indicates a hazardous situation which, if not avoided, will result in death or serious injury.

WARNING

WARNING indicates a hazardous situation which, if not avoided, could result in death or serious injury.

CAUTION

CAUTION indicates a hazardous situation which, if not avoided, could result in minor or moderate injury.

NOTICE

NOTICE is used to address practices not related to physical injury.

IMPORTANT SAFETY INSTRUCTIONS

⚠ WARNING

California Proposition 65: This product contains chemicals and produces exhaust known to the State of California to cause cancer, birth defects and other reproductive harm.

⚠ DANGER

Generator exhaust contains carbon monoxide, a colorless, odorless, poison gas. Breathing carbon monoxide will cause nausea, dizziness, fainting or death. If you start to feel dizzy or weak, get to fresh air immediately.

OPERATE GENERATOR OUTDOORS ONLY IN A WELL VENTILATED AREA.

DO NOT operate the generator inside any building, including garages, basements, crawlspaces and sheds, enclosure or compartment, including the generator compartment of a recreational vehicle.

DO NOT allow exhaust fumes to enter a confined area through windows, doors, vents or other openings.

⚠ DANGER

Using a generator indoors **CAN KILL YOU IN MINUTES**. Generator exhaust contains carbon monoxide. This is a poison you cannot see or smell.

NEVER use inside a home or garage, **EVEN IF** doors and windows are open.

ONLY use **OUTSIDE** and far away from windows, doors, and vents.

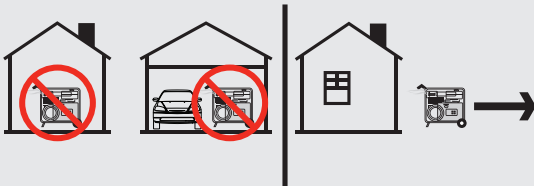

Install battery-operated carbon monoxide alarms or plug-in carbon monoxide alarms with battery back-up according to the manufacturer's instructions.

⚠ DANGER

Rotating parts can entangle hands, feet, hair, clothing and/or accessories. Traumatic amputation or severe laceration can result.

Keep hands and feet away from rotating parts.

Tie up long hair and remove jewelry.

Operate equipment with guards in place.

DO NOT wear loose-fitting clothing, dangling drawstrings or items that could become caught.

⚠ WARNING

Operation of this equipment may create sparks that can start fires around dry vegetation.

A spark arrestor may be required. The operator should contact local fire agencies for laws or regulations relating to fire prevention requirements.

⚠ DANGER

Generator produces powerful voltage.

DO NOT touch bare wires or receptacles.

DO NOT use electrical cords that are worn, damaged or frayed. Use Champion electrical cords only for proper application.

DO NOT operate generator in wet weather.

DO NOT allow children or unqualified persons to operate or service the generator

Use a ground fault circuit interrupter (GFCI) in damp areas and areas containing conductive material such as metal decking.

Connection to your home's electrical system requires a listed 30A transfer switch installed by a licensed electrician and approved by the local authority having jurisdiction. The connection must isolate the generator from the utility power and must comply with all applicable laws and electrical codes.

⚠ WARNING

Sparks can result in fire or electrical shock.

When servicing the generator:

Disconnect the spark plug wire and place it where it cannot contact the plug.

DO NOT check for spark with the plug removed.

Use only approved spark plug testers.

⚠ WARNING

Running engines produce heat. Severe burns can occur on contact. Combustible material can catch fire on contact.

DO NOT touch hot surfaces.

Avoid contact with hot exhaust gases.

Allow equipment to cool before touching.

Maintain at least 3 ft. (91.4 cm) of clearance on all sides to ensure adequate cooling.

Maintain at least 5 ft. (1.5 m) of clearance from combustible materials.

⚠ WARNING

Rapid retraction of the starter cord will pull hand and arm towards the engine faster than you can let go. Unintentional startup can result in entanglement, traumatic amputation or laceration. Broken bones, fractures, bruises or sprains could result.

When starting engine, pull the starter cord slowly until resistance is felt and then pull rapidly to avoid kickback.

DO NOT start or stop the engine with electrical devices plugged in and turned on.

⚠ CAUTION

Exceeding the generator's running capacity can damage the generator and/or electrical devices connected to it.

DO NOT overload the generator.

Start the generator and allow the engine to stabilize before connecting electrical loads.

Connect electrical equipment in the off position, and then turn them on for operation.

Turn electrical equipment off and disconnect before stopping the generator.

DO NOT tamper with the governed speed.

DO NOT modify the generator in any way.

⚠ CAUTION

Improper treatment or use of the generator can damage it, shorten its life and void your warranty.

Use the generator only for intended uses.

Operate only on level surfaces.

DO NOT expose generator to excessive moisture, dust, or dirt.

DO NOT allow any material to block the cooling slots.

If connected devices overheat, turn them off and disconnect them from the generator.

DO NOT use the generator if:

- Electrical output is lost
- Equipment sparks, smokes or emits flames
- Equipment vibrates excessively

⚠ WARNING

Medical and life support uses.

In case of emergency, call 911 immediately.

NEVER use this product to power life support devices or life support appliances.

NEVER use this product to power medical devices or medical appliances.

Inform your electricity provider immediately if you or anyone in your household depends on electrical equipment to live.

Inform your electrical provider immediately if a loss of power would cause you or anyone in your household to experience a medical emergency.

Fuel Safety

⚠ DANGER

GASOLINE, GASOLINE VAPORS AND PROPANE (LPG) ARE HIGHLY FLAMMABLE AND EXPLOSIVE.

Fire or explosion can cause severe burns or death.

Gasoline and gasoline vapors:

- Gasoline is highly flammable and explosive.
- Gasoline can cause a fire or explosion if ignited.
- Gasoline is a liquid fuel but it's vapors can ignite.
- Gasoline is a skin irritant and needs to be cleaned up immediately if spilled on skin or clothes.
- Gasoline has a distinctive odor, this will help detect potential leaks quickly.
- In any petroleum gas fire, flames should not be extinguished unless by doing so the fuel supply valve can be turned OFF. This is because if a fire is extinguished and a supply of fuel is not turned OFF, then an explosion hazard could be created.
- Gasoline expands or contracts with ambient temperatures. Never fill the gasoline tank to full capacity, as gasoline needs room to expand if temperatures rise.

LPG:

- LPG is highly flammable and explosive.
- LPG is under pressure and can cause a fire or explosion if ignited.
- LPG is heavier than air and can settle in low places while dissipating.
- LPG has a distinctive odor added to help detect potential leaks quickly.
- In any petroleum gas fire, flames should not be extinguished unless the fuel supply valve is turned OFF. This is because if a fire is extinguished and a supply of fuel is not turned OFF, then an explosion hazard could be created.
- When exchanging LPG cylinders, be sure the cylinder valve is of the same type.
- Always keep the LPG cylinder in an upright position.
- LPG will burn skin if it comes in contact with it. Keep any and all LPG away from skin at all times.

When adding or removing gasoline:

Turn the generator off and let it cool for at least two minutes before removing the gasoline cap. Loosen the cap slowly to relieve pressure in the tank.

Only fill or drain gasoline outdoors in a well-ventilated area.

DO NOT pump gasoline directly into the generator at the gas station. Use an approved container to transfer the fuel to the generator.

DO NOT overfill the gasoline tank.

Always keep gasoline away from sparks, open flames, pilot lights, heat and other sources of ignition.

DO NOT light or smoke cigarettes.

When starting the generator:

DO NOT attempt to start a damaged generator.

Make certain that the gasoline cap, air filter, spark plug, fuel lines and exhaust system are properly in place.

Allow spilled gasoline to evaporate fully before attempting to start the engine.

Make certain that the generator is resting firmly on level ground.

When operating the generator:

DO NOT move or tip the generator during operation.

DO NOT tip the generator or allow fuel or oil to spill.

When transporting or servicing the generator:

Make certain that the fuel valve is in the OFF position, the gasoline tank is empty.

For LPG compatible models, be sure that the LPG cylinder is disconnected and stored securely away from the generator.

Disconnect the spark plug wire.

When storing the generator:

Store away from sparks, open flames, pilot lights, heat and other sources of ignition.









Do not store generator, gasoline or LPG cylinders near furnaces, water heaters, or any other appliances that produce heat or have automatic ignitions.

⚠ WARNING

Never use a gasoline container, gasoline tank, LPG connector hose, LPG cylinder or any other fuel item that is damaged or appears damaged.











Safety Symbols









Some of the following symbols may be used on this product. Please study them and learn their meaning. Proper interpretation of these symbols will allow you to more safely operate the product.

SYMBOL	MEANING
	Read Operator's Manual. To reduce the risk of injury, user must read and understand operator's manual before using this product.
	Clearance. Keep all objects at least 5 feet from this machine. Heat from the muffler and exhaust gas can ignite combustible objects.
	Ground. Consult with local electrician to determine grounding requirements before operation.
	Electric Shock. Failure to use in dry conditions and to observe safe practices can result in electric shock. Improper connections to a building can allow current to backfeed into utility lines, creating an electrocution hazard. A transfer switch must be used when connecting to a building.
	Fire/Explosion. Fuel and its vapors are extremely flammable and explosive. Fire or explosion can cause severe burns or death. Operation of this equipment may create sparks that can start fires around dry vegetation. A spark arrestor may be required. The operator should contact local fire agencies for laws or regulations relating to fire prevention requirements.
	Hot Surface. To reduce the risk of injury or damage, avoid contact with any hot surface.
	Open Flame Alert. Fuel and its vapors are extremely flammable and explosive. Keep fuel away from smoking, open flames, sparks, pilot lights, heat, and other ignition sources.
	Wet Conditions Alert. Do not expose to rain or use in damp locations.

Operation Symbols

Some of the following symbols may be used on this product. Please study them and learn their meaning. Proper interpretation of these symbols will allow you to more safely operate the product.

SYMBOL		MEANING
		Start.
		Check Oil Level. Recommended oil is 10W-30. The engine can be seriously damaged without oil. Always check the oil level before using. The machine must be resting firmly on level ground when checking.
		Check Fuel Level. Use clean, fresh, regular unleaded gasoline with a minimum octane rating of 85 and an ethanol content of less than 10% by volume.
		Fuel Valve ON.
		Engine Switch ON. Press the Engine Switch to "ON" position.
		Choke. Move choke lever to "CHOKE" position.
		Recoil Starter. Pull recoil starter to start the engine.
		Choke. Move choke lever to "RUN" position.
		Plug In. Plug in desired devices.
		Unplug. Unplug devices when turning generator off.

SYMBOL	MEANING
	Engine Switch OFF. Press the Ignition Switch to "OFF" position.
	Fuel Valve OFF.
	Stop.
	Hertz. Shown on Intelligauge as "F##.#"
	Volts. Shown on Intelligauge as "U###"
	Runtime. Shown on Intelligauge as "###.#"
	Engine ON
	Engine OFF

Safety Labels

These labels warn you of potential hazards that can cause serious injury. Read them carefully.

If a label comes off or becomes hard to read, contact Technical Support Team for possible replacement.

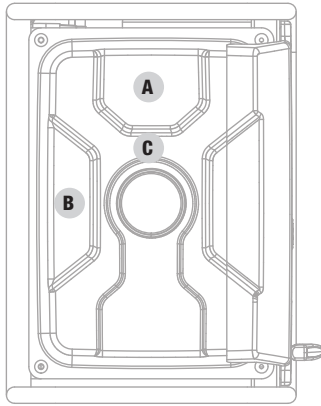

Top

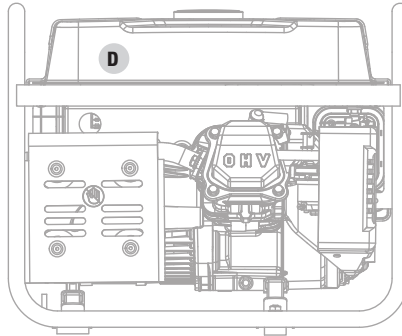

Back

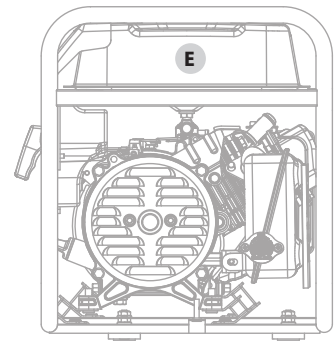

Right

	LABEL	DESCRIPTION
A	<p>⚠ DANGER Using a generator indoors CAN KILL YOU IN MINUTES. Generator exhaust contains carbon monoxide. This is a poison you cannot see or smell.</p> <p>NEVER use inside a home or garage, EVEN IF doors and windows are open. ONLY use OUTSIDE and far away from windows, doors, and vents.</p> <p>⚠ PELIGRO El uso de un generador en interiores PUEDA MATARLO EN MINUTOS. El escape del generador contiene monóxido de carbono. Este es un veneno que no se puede ver ni oler. NUNCA lo use dentro del hogar ni el garaje. INCLUSO si las puertas y ventanas están abiertas. Úselo SÓLO a la INTemperIE lejos de ventanas, puertas, y orificios de ventilación.</p> <p>⚠ DANGER Utiliser un générateur à l'intérieur PEUT VOUS TUER EN QUELQUES MINUTES. L'échappement du générateur contient du monoxyde de carbone. Il s'agit d'un poison que vous ne pouvez ni voir ni sentir. Ne l'utilisez JAMAIS dans la maison ou le garage MÊME si les portes et les fenêtres sont ouvertes. Utilisez-le UNIQUEMENT À L'EXTERIEUR, loin des fenêtres, portes et trappes de ventilation.</p> <p>100403-01-A</p>	CO Danger
B	<p>100403-01-B</p>	Safety Icons
C	<p>UNLEADED FUEL ONLY. Minimum octane rating of 85. Maximum 10% ethanol.</p> <p>GASOLINA REGULAR SOLAMENTE. 85 octanos como mínimo. Máximo de etanol de 10%.</p> <p>ESSENCE SANS PLOMB SEULEMENT. Indice d'octane minimal de 85. Maximum 10 % d'éthanol.</p> <p>E85 E85 E10</p> <p>1002-L-0P-1-A</p>	Fuel
D	<p>⚠ WARNING DO NOT TOUCH Hot surfaces, muffler and engine components are extremely HOT and cause burns.</p> <p>⚠ ADVERTENCIA ¡NO TOCAR! Los gases de escape, el silenciador y los componentes del motor están extremadamente CALIENTES y causan quemaduras.</p> <p>⚠ AVERTISSEMENT NE PAS TOUCHER Les gaz d'échappement, le silencieux et les pièces du moteur sont extrêmement CHAUDS et peuvent causer des brûlures.</p> <p>100403-01-D</p>	Hot Surface
E	<p>⚠ WARNING Operation of this equipment may create sparks that can start fires around the generator. A spark arrester may be required. The operator should consult with the appropriate fire laws and regulations relating to the prevention of fire hazards. Consult local fire codes for more information. Si se está utilizando, siempre encienda el equipo inmediatamente.</p> <p>⚠ ADVERTENCIA La operación de este equipo puede producir chispas que pueden provocar incendios al rodearlo de vegetación seca. Se requiere un dispositivo de extinción de incendios para las áreas que se están utilizando. Consulte con las leyes y regulaciones relacionadas con la prevención de incendios para obtener más información. Si se está utilizando, siempre encienda el equipo inmediatamente.</p> <p>⚠ AVERTISSEMENT Cet équipement peut créer des étincelles et provoquer un incendie dans la végétation sèche. Un dispositif d'extinction peut être requis. L'opérateur doit consulter avec les services d'incendie local pour connaître les lois et les règlements en matière de prévention des incendies. Si c'est le cas, consultez toujours les lois. Ne jamais allumer l'équipement sans le faire immédiatement.</p> <p>100403-01-E</p>	Spark Arrestor

CONTROLS AND FEATURES

Read this operator's manual before operating your generator. Familiarize yourself with the location and function of the controls and features. Save this manual for future reference.

Generator

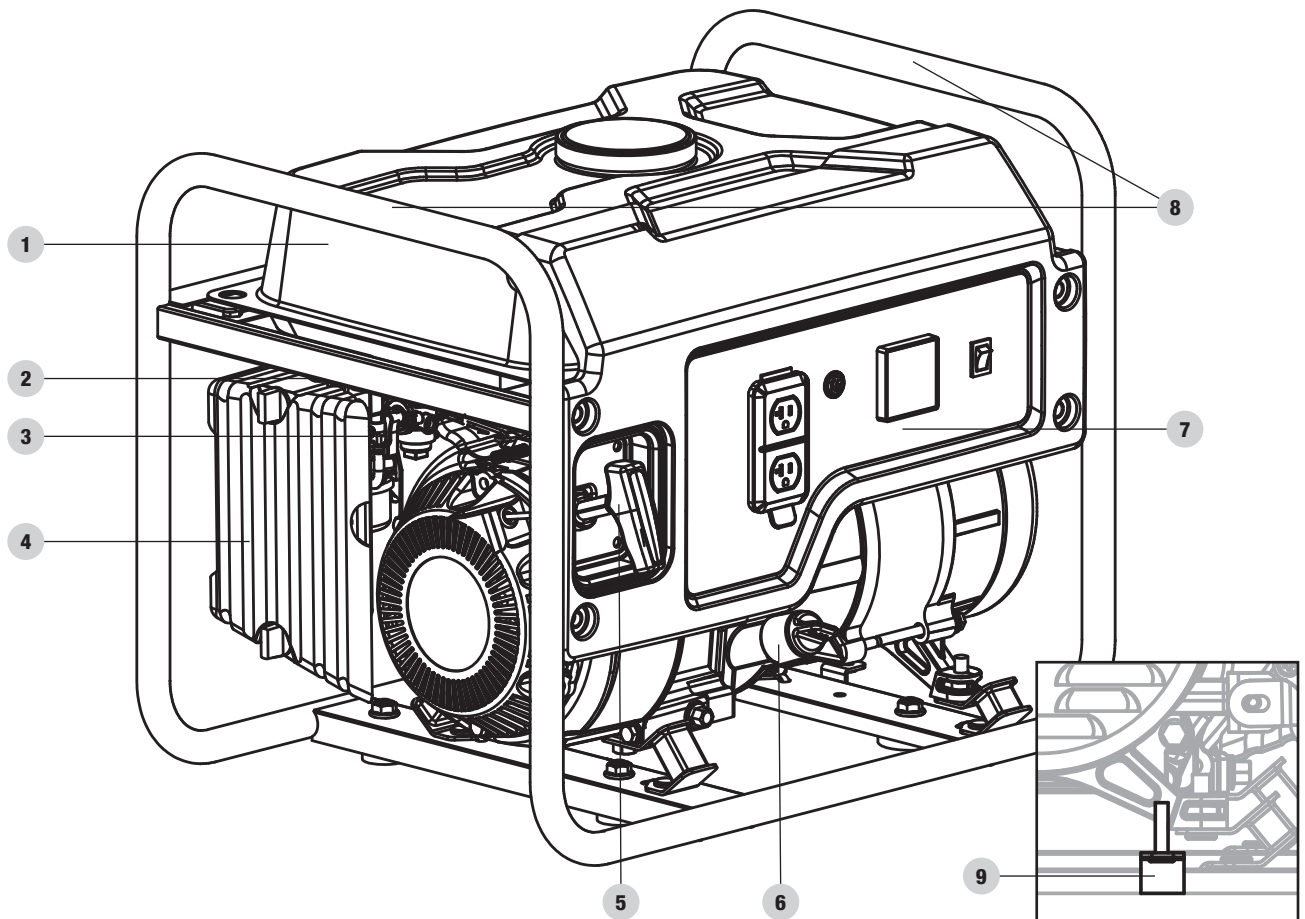

1. **Gasoline Tank** – 1.9 gal. (7 L)
2. **Choke** – Used to start the engine.
3. **Fuel Valve** – Used to turn fuel supply on and off to engine.
4. **Air Filter** – Protects the engine by filtering dust and debris from the intake air.
5. **Recoil Starter** – Used to manually start the engine.
6. **Oil Fill Cap/Dipstick** – Used to check and fill oil level.
7. **Control Panel** – See “Control Panel” section.
8. **Carrying Handle(s)** – Used to lift or carry the unit.
9. **Ground Terminal** – Consult an electrician for local grounding regulations.

Control Panel

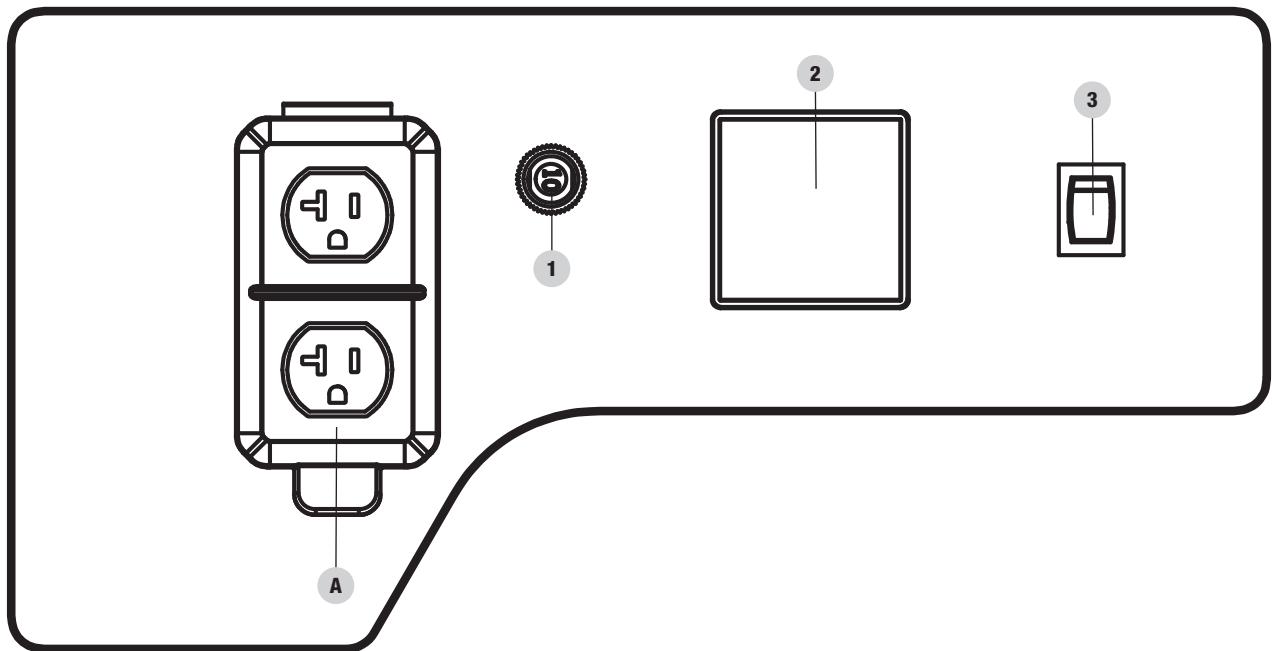

1. **Circuit Breakers (Push Reset)** – Protects the generator against electrical overloads.
2. **Intelligauge** – Three mode digital meter for displaying running time, voltage and hertz.
3. **Engine Switch** – Used to START or STOP the generator.

RECEPTACLES	
A	 <p>120V AC, 20A (NEMA 5-20R) May be used to supply electrical power for operation of 120 Volt AC, 20 Amp, single phase, 60 Hz electrical loads.</p>

Parts Included

Accessories

Oil Funnel..... 1

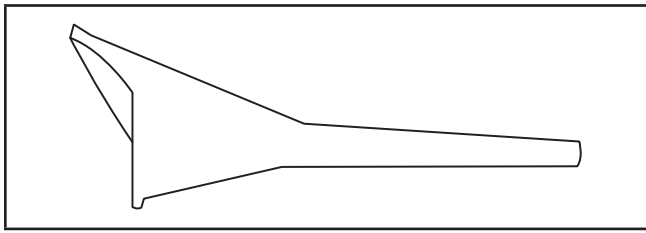

Assembly Parts

Vibration Mounts (engine side) (A)..... 2
 Vibration Mounts (alternator side) (B)..... 2
 Flange Bolt M8 × 20 (C)..... 2
 Lock Nut M8 (D)..... 4

ASSEMBLY

Your generator requires some assembly. This unit ships from our factory without oil. It must be properly serviced with fuel and oil before operation.

If you have any questions regarding the assembly of your generator, call our Technical Support Team at 1-877-338-0999. Please have your serial number and model number available.

Unpacking

1. Set the shipping carton on a solid, flat surface.
2. Remove everything from the carton except the generator.
3. Carefully cut each corner of the box from top to bottom. Fold each side flat on the ground to provide a surface area to work with the generator.

Attach Vibration Mounts

Attach the Engine Vibration Mounts

1. Thread the vibration mount bolt (A) through the frame (engine side).
2. Firmly secure the vibration mount bolt to the frame with the M8 lock nut (D). DO NOT over tighten.
3. Repeat steps 1-2 for the remaining mount (2 total).

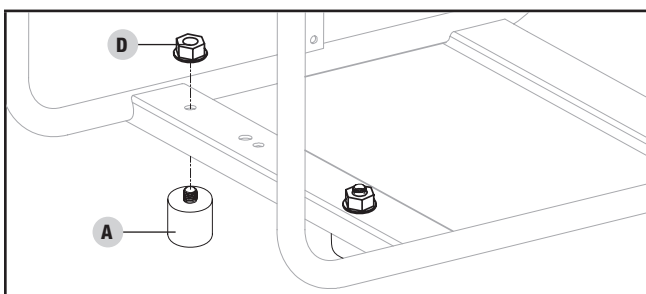

Attach the Alternator Vibration Mounts

1. Thread the flange bolt (C) through the vibration mount (B) and then through the frame (alternator side).
2. Firmly secure the bolt to the frame with the M8 lock nut (D). DO NOT over tighten.
3. Repeat steps 1-2 for the remaining mount (2 total).

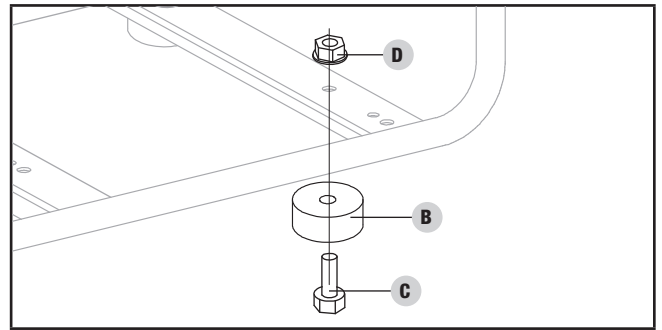

Add Engine Oil

CAUTION

DO NOT attempt to crank or start the engine before it has been properly filled with the recommended type and amount of oil. Damage to the generator as a result of failure to follow these instructions will void your warranty.

NOTICE

The generator rotor has a sealed, pre-lubricated ball bearing that requires no additional lubrication for the life of the bearing.

NOTICE

The recommended oil type is **10W-30 automotive oil**.

Recommended Oil Type / Tipo de aceite recomendado / Type d'huile recommandé	
	10W-30
	5W-30 10W-40
	5W-30 Synthetic / Sintético / Synthétique
°F	-20 0 20 40 60 80 100 120
°C	-28.9 -17.8 -6.7 4.4 15.6 26.7 37.8 48.9
Ambient temperature / Temperatura ambiente / Température ambiante	

1. Place the generator on a flat, level surface.
2. Remove oil fill cap/dipstick to add oil.
3. Using a funnel, add up to 0.4 qt. (0.4 L) of oil (not included) and replace oil fill cap/dipstick. DO NOT OVERFILL.

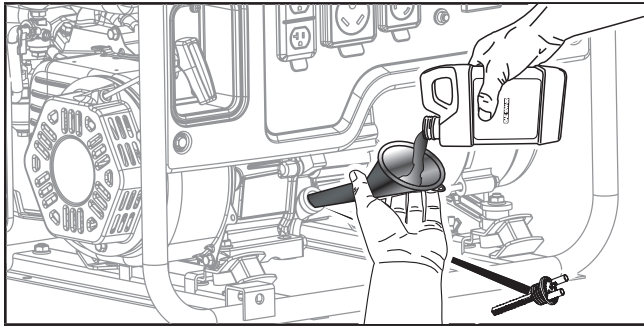

4. Check engine oil level daily and add as needed.

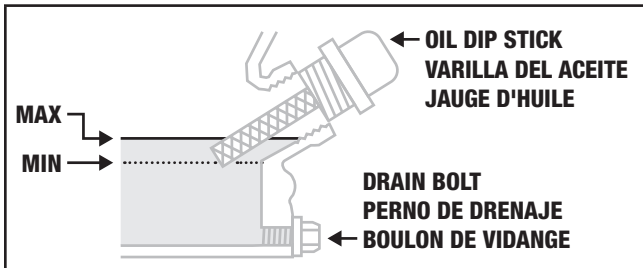

NOTICE

Once oil has been added, a visual check should show oil about 1-2 threads from running out of the fill hole.

If using the dipstick to check oil level, DO NOT screw in the dipstick while checking.

NOTICE

Check oil often during the break-in period. Refer to the [Maintenance](#) section for recommended service intervals.

CAUTION

The engine is equipped with a low oil shut-off and will stop when the oil level in the crankcase falls below the threshold level.

NOTICE

The first 5 hours of run time are the break-in period for the unit. During the break in period stay at or below 50% of the running watt rating and vary the load occasionally to allow stator windings to heat and cool. Adjusting the load will also cause engine speed to vary and help seat piston rings. After the 5 hour break-in period, change the oil.

NOTICE

Weather will affect engine oil and engine performance. Change the type of engine oil used based on weather conditions to suit the engine needs.

NOTICE

Synthetic oil may be used after the 5 hour initial break-in period. Using synthetic oil does not increase the recommended oil change interval. Full synthetic 5W-30 oil will aid in starting in cold ambient <math><5^{\circ}\text{C}</math> (41° F).

Add Fuel

1. Use clean, fresh, regular unleaded gasoline with a minimum octane rating of 85 and an ethanol content of less than 10% by volume.
2. DO NOT mix oil with gasoline.
3. Remove the gasoline cap.
4. Slowly add gasoline to the tank. Tank is full when gasoline reaches red circle on screen. DO NOT OVERFILL. Gasoline can expand after filling. A minimum of ¼ in. (6.4 mm) of space left in the tank is required for gasoline expansion, although more than ¼ in. (6.4 mm) is recommended. Gasoline can be forced out of the tank as a result of expansion if overfilled, and can affect the stable running condition of the generator.

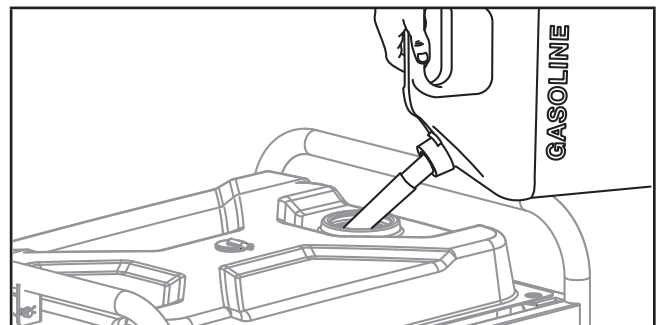

5. Screw on the gasoline cap and wipe away any spilled fuel.

CAUTION

Use regular unleaded gasoline with a minimum octane rating of 85 and an ethanol content of less than 10% by volume.

DO NOT mix oil and gasoline.

Fill tank to approximately ¼ in. (6.4 mm) below the top of the tank to allow for gasoline expansion.

DO NOT pump gasoline directly into the generator at the pump. Use an approved container to transfer the gasoline to the generator.

DO NOT fill tank indoors.

DO NOT fill tank when the engine is running or hot.

DO NOT overfill the tank.

DO NOT light cigarettes or smoke when filling the tank.

⚠ WARNING

Pouring gasoline too fast through the fuel screen may result in blow back of gasoline at the operator while filling.

🗨 NOTICE

Our engines work well with 10% or less ethanol blend gasoline. When using ethanol-gasoline blends there are some issues worth noting:

- Ethanol-gasoline blends can absorb more water than gasoline alone.
- These blends can eventually separate, leaving water or a watery goo in the tank, fuel valve and carburetor.
- With gravity-fed supplies, the compromised gasoline can be drawn into the carburetor and cause damage to the engine and/or potential hazards.
- There are only a few suppliers of fuel stabilizer that are formulated to work with ethanol-gasoline blends.
- Any damages or hazards caused by using improper gasoline, improperly stored gasoline, and/or improperly formulated stabilizers, are not covered by manufacturer's warranty.

It is advisable to always shut off the gasoline supply, run the engine to starvation and drain the tank when the equipment is not in use for more than 30 days.

Grounding

Your generator must be properly connected to an appropriate ground to help prevent electric shock.

⚠ WARNING

Failure to properly ground the generator can result in electric shock.

A ground terminal connected to the frame of the generator has been provided (see [Controls and Features](#) for terminal location). For remote grounding, connect a length of heavy gauge (12 AWG minimum) copper wire between the generator ground terminal and a copper rod driven into the ground. We strongly recommend that you consult with a qualified electrician to ensure compliance with local electrical codes.

OPERATION**Generator Location**

NEVER operate the generator inside any building, including garages, basements, crawlspaces and sheds, enclosure or compartment, including the generator compartment of a recreational vehicle. Please consult your local authority. In some areas, generators must be registered with the local utility. Generators used at construction sites may be subject to additional rules and regulations. Generators should be on a flat, level surface at all times. (Even while not in operation) Generators must have at least 5 ft. (1.5 m) of clearance from all combustible material. In addition to clearance from all combustible material, generators must also have at least 3 ft. (91.4 cm) of clearance on all sides to allow for adequate cooling, maintenance and servicing. Generators should never be started or operated in the back of a SUV, camper, trailer, in the bed of a truck (regular, flat or otherwise), under staircases/stairwells, next to walls or buildings, or in any other location that will not allow for adequate cooling of the generator and/or the muffler. DO NOT contain generators during operation. Allow generators to properly cool before transport or storage.

Install battery-operated carbon monoxide alarms or plug-in carbon monoxide alarms with battery back-up in your home according to the manufacturer's instructions.

Place the generator in a well-ventilated area. DO NOT place the generator near vents or intakes where exhaust fumes could be drawn into occupied or confined spaces. Carefully consider wind and air currents when positioning generator.

Failure to follow proper safety precautions may void manufacturer's warranty.

⚠ WARNING

Do not operate or store the generator in rain, snow, or wet weather.

Using a generator or electrical appliance in wet conditions, such as rain or snow, or near a pool or sprinkler system, or when your hands are wet, could result in electrocution.

⚠ WARNING

During operation the muffler and exhaust fumes produced will become hot. If adequate cooling and breathing space are not supplied, or if the generator is blocked or contained, temperatures can become extremely heated and may lead to fire.

Grounding*

A ground terminal connected to the frame of the generator has been provided (see [Controls and Features](#) for terminal location).

Neutral Floating

- The generator (stator winding) is isolated from the frame and from the AC receptacle ground pin.
- Electrical devices that require a grounded receptacle pin connection will not function if the receptacle ground pin is not functional.

Neutral Bonded to Frame

The generator system ground connects lower frame cross-member below the alternator. The system ground is connected to the AC neutral wire.

**See your model's control panel for specified type of grounding.*

Surge Protection

Electronic devices, including computers and many programmable appliances use components that are designed to operate within a narrow voltage range and may be affected by momentary voltage fluctuations. While there is no way to prevent voltage fluctuations, you can take steps to protect sensitive electronic equipment.

- Install UL1449, CSA-listed, plug-in surge suppressors on the outlets feeding your sensitive equipment.
Surge suppressors come in single- or multi-outlet styles. They're designed to protect against virtually all short-duration voltage fluctuations.

Starting the Engine

1. Make certain the generator is on a flat, level surface.
2. Disconnect all electrical loads from the generator. Never start or stop the generator with electrical devices plugged in or turned on.
3. Turn the gasoline fuel valve to the "ON" position.
4. Move the choke to the "CHOKE" position.
5. For restarting a warm engine, move the choke to 75% of the "CHOKE" position.
6. Push the engine switch to the "ON" position.
7. Pull the starter cord slowly until resistance is felt and then pull rapidly
8. Do not over-choke. As soon as engine starts, move the choke to the "RUN" position over a 2-5 second duration.

NOTICE

Keep choke in "CHOKE" position for only 1 pull of the recoil starter. After first pull, move choke to the "RUN" position for up to the next 3 pulls of the recoil starter. Too much choke leads to spark plug fouling/engine flooding due to the lack of incoming air. This will cause the engine not to start.

NOTICE

For gasoline restarts with hot engine in hot ambient > 30°C (86°F), keep the choke in 75% of the "CHOKE" position for only 1 pull of the recoil starter. After first pull, move choke to the "RUN" position for up to 3 more pulls of the recoil starter. Too much choke leads to spark plug fouling/engine flooding due to the lack of incoming air. This will cause the engine not to start.

NOTICE

For gas starting in cold ambient < 15°C (59°F) the choke must be in 100% of the "CHOKE" position for recoil start procedures. Do not over-choke. As soon as engine starts, gradually move the choke lever to the "RUN" position over a 2-5 second duration.

Connecting Electrical Loads

Let the engine stabilize and warm up for a few minutes after starting.

Plug in and turn on the desired 120 or 240 (if applicable) Volt AC single phase, 60 Hz electrical loads.

- DO NOT connect 3-phase loads to the generator.
- DO NOT connect 50 Hz loads to the generator.
- DO NOT overload the generator.

⚠ WARNING

Connecting a generator to your electric utility company's power lines or to another power source may be against the law. In addition this action, if done incorrectly, could damage your generator and appliances and could cause serious injury or even death to you or a utility worker who may be working on nearby power lines. If you plan to run a portable electric generator during an outage, please notify your electric utility company immediately and remember to plug your appliances directly into the generator. Do not plug the generator into any electric outlet in your home. Doing so could create a connection to the utility company power lines. You are responsible for ensuring that your generator's electricity does not feed back into the electric utility power lines.

If the generator will be connected to a building electrical system, consult your local utility company or a qualified electrician. Connections must isolate generator power from utility power and must comply with all applicable laws and codes.

Do Not Overload Generator**Capacity**

Follow these simple steps to calculate the running and starting watts necessary for your purposes:

1. Select the electrical devices you plan on running at the same time.
2. Total the running watts of these items. This is the amount of power you need to keep your items running.
3. Identify the highest starting wattage of all devices identified in step 1. Add this number to the number calculated in step 2. Starting wattage is the extra burst of power needed to start some electric driven equipment. Following the steps listed under "Power Management" will guarantee that only one device will be starting at a time.

Power Management

Use the following formula to convert voltage and amperage to watts:

$$\text{Volts} \times \text{Amps} = \text{Watts}$$

To prolong the life of your generator and attached devices, follow these steps to add electrical load:

1. Start the generator with no electrical load attached
2. Allow the engine to run for several minutes to stabilize.
3. Plug in and turn on the first item. It is best to attach the item with the largest load first.
4. Allow the engine to stabilize.

5. Plug in and turn on the next item.
6. Allow the engine to stabilize.
7. Repeat steps 5-6 for each additional item.

🗨 NOTICE

Never exceed the specified capacity when adding loads to the generator.

Stopping the Engine

1. Turn off and unplug all electrical loads. Never start or stop the generator with electrical devices plugged in or turned on.
2. Let the generator run at no-load for several minutes to stabilize internal temperatures of the engine and generator.
3. Turn the fuel valve to the "OFF" position.
4. Let the engine run until fuel starvation has stopped the engine. This usually takes a few minutes.
5. Press the engine switch to the "OFF" position.

Important: Always ensure that the fuel valve and the engine switch are in the "OFF" position when the generator is not in use.

🗨 NOTICE

If the engine will not be used for a period of two (2) weeks or longer, please see the [Storage](#) section for proper engine and fuel storage.

MAINTENANCE

Make certain that the generator is kept clean and stored properly. Only operate the unit on a flat, level surface in a clean, dry operating environment. DO NOT expose the unit to extreme conditions, excessive dust, dirt, moisture or corrosive vapors.

⚠ WARNING

Never operate a damaged or defective generator.

⚠ WARNING

Improper maintenance will void your warranty.

🗨 NOTICE

Maintenance, replacement, or repair of emission control devices and systems may be performed by any non-road engine repair establishment or individual.

The owner/operator is responsible for all periodic maintenance.

Complete all scheduled maintenance in a timely manner.

Correct any issue before operating the generator.

For service or parts assistance, contact our Technical Support Team at 1-877-338-0999.

Cleaning the Generator

⚠ CAUTION

DO NOT spray engine with water.

Water can enter the generator through the cooling slots and damage the generator windings. It can also contaminate the fuel system.

1. Use a damp cloth to clean exterior surfaces of the generator.
2. Use a soft bristle brush to remove dirt and oil.
3. Use an air compressor (25 PSI) to clear dirt and debris from the generator.
4. Inspect all air vents and cooling slots to ensure that they are clean and unobstructed.

To prevent accidental starting, remove and ground the spark plug wire before performing any service.

Changing the Engine Oil

Change oil when the engine is warm. Refer to the oil specification to select the proper grade for your operating environment.

1. Remove the oil drain plug with a 12 mm socket (not included) and extension.
2. Allow the oil to drain completely into an appropriate container.
3. Replace the oil drain plug.
4. Remove the oil fill cap/dipstick to add oil.

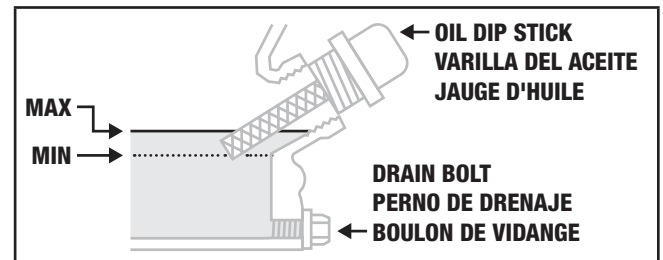

5. Add oil according to "Add Engine Oil" on Assembly section. DO NOT OVERFILL. Oil not included for routine maintenance.
6. Dispose of used oil at an approved waste management facility.

🗨 NOTICE

Once oil has been added, a visual check should show oil about 1-2 threads from running out of the fill hole. If using the dipstick to check oil level, DO NOT screw in the dipstick while checking.

Cleaning and Adjusting the Spark Plug(s)

1. Remove the spark plug cable from the spark plug.
2. Use a spark plug socket tool (not included), or a 13/16 in. (21 mm) socket (not included) to remove the plug.
3. Inspect the electrode on the plug. It must be clean and not worn to produce the spark required for ignition.
4. Make certain the spark plug gap is 0.028-0.031 in. (0.7-0.8 mm).

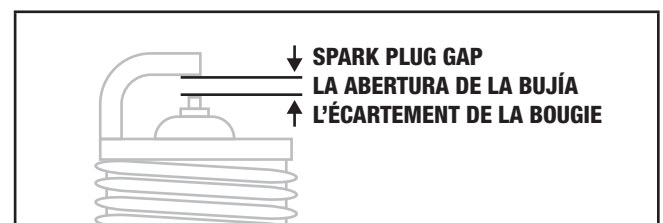

5. Refer to the spark plug types in [Specifications](#) when replacing the plug.

6. Firmly re-install the plug.
7. Attach the spark plug cable to the spark plug.

Cleaning the Air Filter

1. Remove the snap-on cover holding the air filter to the assembly.
2. Remove the foam element.
3. Wash in liquid detergent and water. Squeeze thoroughly dry in a clean cloth.
4. Saturate in clean engine oil.
5. Squeeze in a clean, absorbent cloth to remove all excess oil.
6. Place the filter in the assembly.
7. Reattach the air filter cover and snap in place.

Cleaning the Spark Arrestor

1. Allow the engine to cool completely before servicing the spark arrestor.
2. Remove the two or three screws (varies by model) holding the cover plate which retains the spark arrestor to the muffler.
3. Remove the spark arrestor screen.
4. Carefully remove the carbon deposits from the spark arrestor screen with a wire brush.

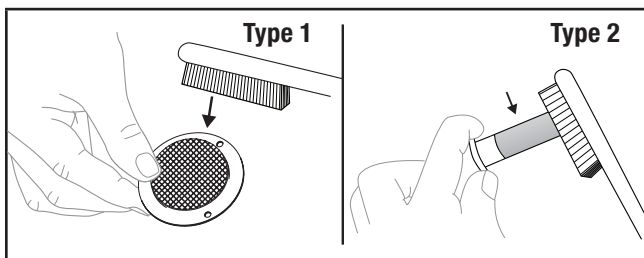

*See your model's parts list for specified type of spark arrestor.

5. Replace the spark arrestor if it is damaged.
6. Position the spark arrestor on the muffler and attach with the screws removed in step 2.

⚠ CAUTION

Failure to clean the spark arrestor will result in degraded engine performance.

🗨 NOTICE

Federal and local laws and administrative requirements indicate when and where spark arrestors are required. When ordered, spark arrestors are required for operation of this generator in National Forest lands. In California, this generator must not be used on any forest-covered land, brush-covered land, or grass-covered land unless the engine is equipped with a spark arrestor.

Adjusting the Governor

⚠ WARNING

Tampering with the factory set governor will void your warranty.

The air-fuel mixture is not adjustable. Tampering with the governor can damage your generator and your electrical devices and will void your warranty. Contact our Technical Support Team at 1-877-338-0999 for all other service and/or adjustment needs.

Maintenance Schedule

Follow the service intervals indicated in the following maintenance schedule.

Service your generator more frequently when operating in adverse conditions.

Contact our Technical Support Team at 1-877-338-0999 to locate the nearest CPE certified service dealer for your generator or engine maintenance needs.

EVERY 8 HOURS OR DAILY

- Check oil level
- Clean around air intake and muffler

FIRST 5 HOURS

- Change oil

EVERY 50 HOURS OR EVERY SEASON

- Clean air filter
- Change oil if operating under heavy load or in hot environments

EVERY 100 HOURS OR EVERY SEASON

- Change oil
- Clean/adjust spark plug
- Check/adjust valve clearance*
- Clean spark arrestor
- Clean fuel tank and filter*

EVERY 250 HOURS

- Clean combustion chamber*

EVERY 3 YEARS

- Replace fuel line*

*To be performed by knowledgeable, experienced owners or CPE certified service centers.

STORAGE**⚠ DANGER**

Gasoline, gasoline vapors and propane (LPG) are highly flammable and extremely explosive.

Fire or explosion can cause severe burns or death. Only fill or drain fuel outdoors in a well-ventilated area. DO NOT pump gasoline directly into the generator. Use an approved container to transfer the fuel to the generator. Never use a gasoline container, gasoline tank, LPG connector hose, LPG cylinder or any other fuel item that is damaged or appears damaged. DO NOT overfill the gasoline tank. Always keep fuel away from sparks, open flames, pilot lights, heat and other sources of ignition. DO NOT light or smoke cigarettes.

Short Term Storage (up to 1 year)

Gasoline in the gasoline tank has a maximum shelf life of up to 1 year with the addition of properly formulated fuel stabilizers and if stored in a cool, dry place. Gasoline in the carburetor, however, may gum up and clog the carburetor if it isn't used or drained within 2-4 weeks.

1. Be sure all appliances are disconnected from the generator.
2. Add a properly formulated fuel stabilizer to the gasoline tank.
3. Turn the fuel valve to the "ON" position *or, for Dual Fuel models only*, set the fuel selector switch for operation on gasoline.

4. Start and run the generator for 10 minutes so the treated gasoline cycles through the fuel system and carburetor.
5. Turn engine switch to the "OFF" position and allow generator to cool completely before continuing.
6. **Option 1: Drain Gasoline (all models)**
 - 6a. Turn the fuel valve to the "OFF" position *or, for Dual Fuel models ONLY*, set the fuel selector switch for operation on LPG and be sure any LPG fuel source is turned off and disconnected from the generator.
 - 6b. Use the drain bolt on the carburetor to empty any excess gasoline from the carburetor into an appropriate container. Use a funnel (and appropriate hose if necessary) under the carburetor drain bolt to avoid spillage.
 - 6c. When gasoline stops flowing from the carburetor, replace and tighten the carburetor drain bolt and be sure to properly dispose of the drained gasoline according to local regulations or guidelines.
7. **Option 2: Run Dry (gasoline type models ONLY)**
 - 7a. Turn engine switch to the "ON" position and start the generator.
 - 7b. With the generator running, turn the fuel valve to the "OFF" position and allow the generator to run until the engine stops from complete fuel starvation. This may take a few minutes.
 - 7c. Turn engine switch to the "OFF" position and allow generator to cool completely before continuing.
8. Remove the spark plug cap and spark plug and pour about a tablespoon of oil into the cylinder.
9. Pull the recoil slowly to crank the engine to distribute the oil and lubricate the cylinder.
10. Reattach the spark plug and spark plug cap.
11. If the generator includes a battery, disconnect and charge according to [Generator Battery](#).
12. Clean the generator according to [Cleaning the Generator](#).
13. Store the generator in a cool, dry place out of direct sunlight.

Long Term Storage (over 1 year)

For storage over 1 year, the gasoline tank and carburetor must be completely drained of gasoline.

1. Follow steps 1-5 according to [Short Term Storage](#).
2. Use the drain bolt on the carburetor to empty any excess gasoline from the gasoline tank and carburetor into an appropriate container. Use a funnel (and appropriate hose if necessary) under the carburetor drain bolt to avoid spillage.
3. When gasoline stops flowing from the carburetor, replace and tighten the carburetor drain bolt and be sure to properly dispose of the drained gasoline according to local regulations or guidelines.
4. Turn the fuel valve to the "OFF" position *or, for Dual Fuel models ONLY*, set the fuel selector switch for operation on LPG and be sure any LPG fuel source is turned off and disconnected from the generator.
5. Follow steps 8-13 according to [Short Term Storage](#).

Removing from Storage

If the generator has been improperly stored for a long period of time with gasoline in the gasoline tank and/or carburetor, all fuel must be drained and the carburetor must be thoroughly cleaned. This process involves technically advanced tasks. For assistance please call our Technical Support Team at 1-877-338-0999. If the gasoline tank and carburetor were properly emptied of all gasoline prior to the generator being stored, follow the below steps when removing from storage.

1. Add gasoline to the generator according to [Add Fuel: Gasoline](#).
2. Be sure the engine switch is in the "OFF" position.
3. Turn the fuel valve to the "ON" position *or, for Dual Fuel models ONLY*, set the fuel selector switch for operation on gasoline.
4. After 5 minutes check the carburetor and air filter areas for any leaking gasoline. If any leaks are found, the carburetor will need to be disassembled and cleaned or replaced. If no gasoline leaks are found, turn the fuel valve to the "OFF" position *or, for Dual Fuel models ONLY*, set the fuel selector switch for operation on propane (LPG).
5. Check engine oil level and add clean, fresh oil if needed. See [Oil Specifications](#) for proper oil type.
6. Check and clear air filter of any obstructions such as bugs or cobwebs. If necessary, clean air filter according to [Cleaning the Air Filter](#).

7. If the generator includes a battery, connect according to [Connect the Battery](#).
8. Start the generator according to [Starting the Engine](#).

⚠ DANGER

Generator exhaust contains odorless and colorless carbon monoxide gas.

To avoid accidental or unintended ignition of your generator during periods of storage, the following precautions should be followed:

- When storing the generator make sure the engine switch and fuel valve are set to the "OFF" position.
- If your generator includes a battery, disconnect according to [Generator Battery](#).

SPECIFICATIONS

Generator Specifications

Generator Model	100403
Start Type	Manual
Watts (Starting/Running)	1500/1200
AC Volts	120
AC Amps @ 120 (Starting/Running)	12.5/10
Frequency	60 Hz
Phase	Single
Gross Weight	58.4 - 62.8 lb. (26.5 - 28.5 kg)
Net Weight	54.9 lb. (24.9 kg)
Length	19.3 in. (49 cm)
Width	14 in. (35.5 cm)
Height	16 in. (40.7 cm)

*Product carton styles may vary.

Engine Specifications

Model	YF152FD-4-010
Displacement	80 cc
Type	4-Stroke OHV

Oil Specifications

DO NOT OVERFILL.

Type	*See chart below
Capacity	0.4 qt. (0.4 L)

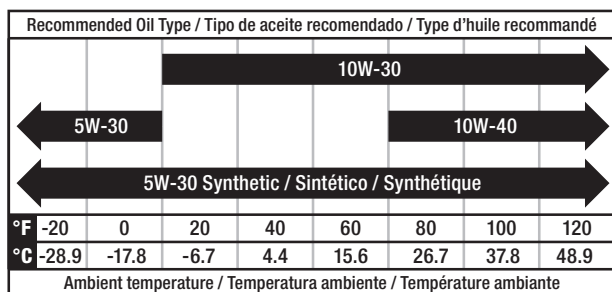

NOTICE

Weather will affect engine oil and engine performance. Change the type of engine oil used based on weather conditions to suit the engine needs.

Fuel Specifications

Use regular unleaded gasoline with a minimum octane rating of 85 and an ethanol content of less than 10% by volume. DO NOT USE E15 or E85. DO NOT OVERFILL.

Gasoline Capacity	1.9 gal. (7 L)
-------------------------	----------------

Spark Plug Specifications

OEM Type	NHSP E6RTC
Replacement Type	NGK BPR6HS or equivalent
Gap	0.028-0.031 in. (0.7-0.8 mm)

Valve Specifications

Intake Clearance	0.005-0.007 in. (0.13-0.17 mm)
Exhaust Clearance	0.007-0.009 in. (0.18-0.22 mm)

NOTICE

A technical bulletin regarding valve adjustment procedures is available at www.championpowerequipment.com.

Temperature Specifications

Starting Temperature Range (°F/°C)	5 to 104/-15 to 40
--	--------------------

NOTICE

An important message about temperature: Your product is designed and rated for continuous operation at ambient temperatures up to 40°C (104°F). When your product is needed it may be operated at temperatures ranging from 5°F (-15°C) to 122°F (50°C) for short periods of time. If exposed to temperatures outside this range during storage, it should be brought back within this range before operation. In any event, the product must always be operated outdoors, in a well-ventilated area and away from doors, windows and vents.

Parts Diagram

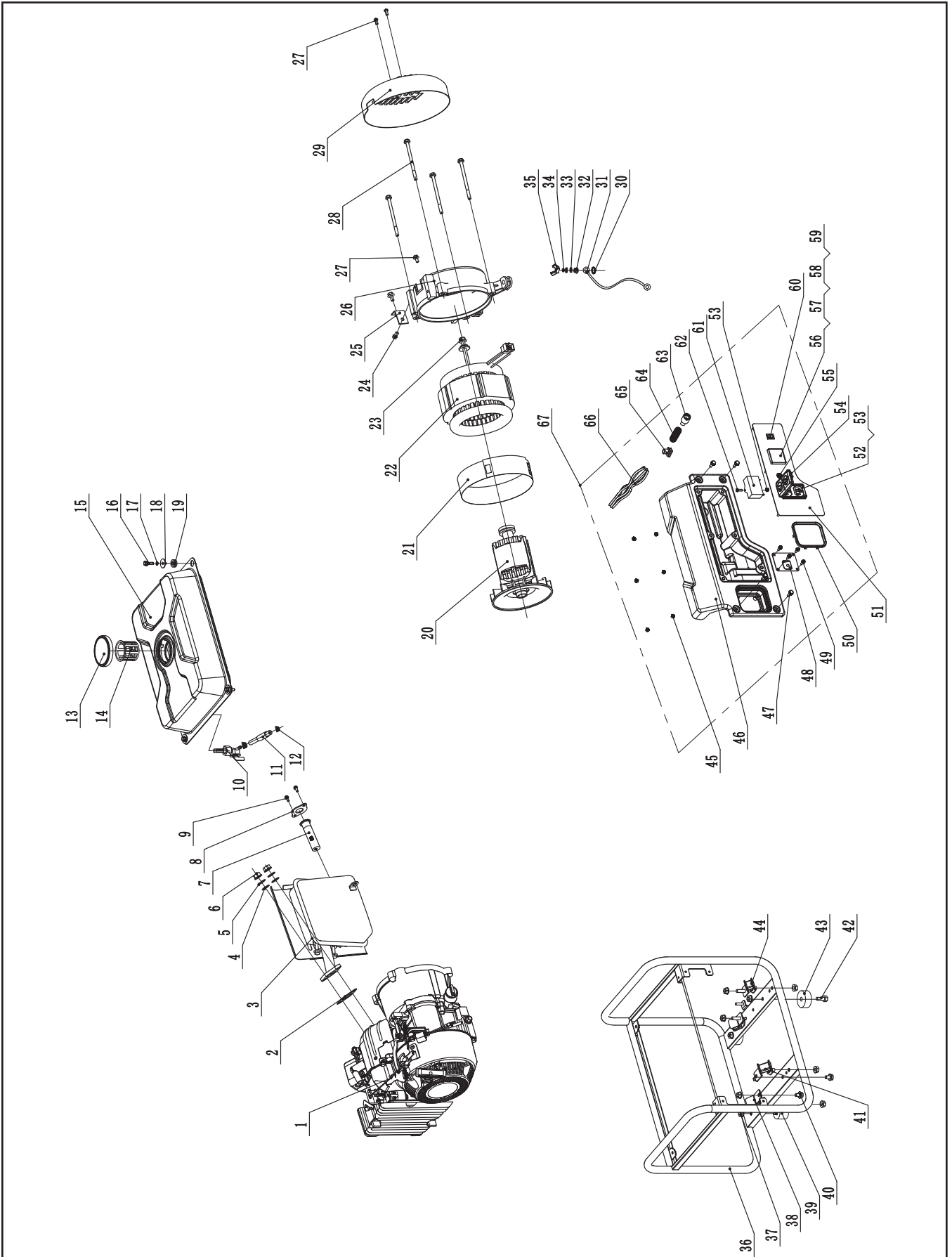

Parts List

#	Part Number	Description	Qty.
1	12.403	Engine, 79.8 cc	1
2	12.100001.02	Gasket, Exhaust	1
3	12.101000.02	Muffler Assembly	1
4	1.848.08	Washer Ø8	2
5	1.93.08	Lock Washer Ø8	2
6	1.6175.08	Nut M8	2
7	46.101300.08	Spark Arrestor Assembly	1
8	46.101503.08	Plate, Spark Arrestor	1
9	1.9074.4.0514	Screw/Washer Assembly M5 × 14	2
10	122.070400.05	Fuel Valve	1
11	113.070011.04	Fuel Pipe 130 mm	1
12	2.06.016	Clamp, Ø8.7 × b8	2
13	113.070100.00	Fuel Tank Cap	1
14	122.070300.02	Fuel Filter	1
15	113.071000.09.48	Fuel Tank, 7L, Yellow	1
16	1.5789.0620.1	Flange Bolt M6 × 20, Gloss Black	4
17	1.93.06	Lock Washer Ø6	4
18	2.03.004.1	Washer, Ø24 × Ø6.5 × 1.5, Black	4
19	122.070015.01	Mount Vibration, Fuel Tank	4
20	113.191100.12	Rotor Assembly, Al, Ø160 × 58 mm	1
21	113.191002.00	Stator Cover	1
22	113.191200.06	Stator Assembly, Al, Ø160 × 58 mm	1
23	2.08.148	Flange Bolt/Washer Assembly M8 × 160	1
24	1.5789.0612	Flange Bolt M6 × 12	2
25	12.100100.01	Bracket, Muffler	1
26	115.190002.00	End Housing	1
27	1.16674.0512.2	Flange Bolt M5 × 12, Flat Black	3
28	2.08.073	Flange Bolt/Washer Assembly M6 × 90	4
29	122.190003.00.48	Generator End Cover, Yellow	1
30	1.862.06	Lock Washer Ø6, Toothed	1
31	5.1900.081	Grounding Line 200 mm	1
32	1.6177.1.06	Lock Nut M6, Flange	1
33	1.97.1.06	Washer Ø6	2
34	1.93.06	Lock Washer Ø6	1

#	Part Number	Description	Qty.
35	1.62.06	Butterfly Type Nut M6	1
36	61148.0.6.2	Frame 490 × 355 × 398mm	1
37	1.6177.1.08	Lock Nut M8, Flange	10
38	113.201200.00	Motor Mount, Left	1
39	122.201400.01	Rubber, Support	2
40	1.16674.0812	Flange Bolt M8 × 12	2
41	113.201200.01	Motor Mount, Right	1
42	1.5783.0820	Bolt M8 × 20	2
43	203.201400.01	Rubber	2
44	113.201200.02	Motor Mount	2
45	1.6177.1.05	Lock Nut M5, Flange	6
46	113.210002.07	Control Box	1
47	1.5789.0615.1	Flange Bolt M6 × 15, Gloss Black	4
48	12.061200.00.2	Guide Plate, Rope, Black	1
49	1.9074.4.0514.1	Screw/Washer Assembly M5 × 14, Black	4
50	113.200106.00	Protector, Front Cover	1
51	113.22.1.2	Control Panel, Black	1
52	5.1120.010	Receptacle 5-20R, Duplex	1
53	1.6177.1.04.1	Lock Nut M4, Flange, Black	3
54	5.1870.008	Receptacle Cover, 5-20R, Duplex	1
55	5.1200.210	10 Amp Circuit Breaker, Push Button	1
56	5.1430.008	Intelligauge	1
57	1.848.03.2	Washer Ø3	4
58	1.859.03.2	Lock Washer Ø3	4
59	1.6175.03.2	Nut M3	4
60	5.1010.003.3	Switch, Red	1
61	5.1860.000	Capacitance	1
62	1.9074.4.0414.1	Screw/Washer Assembly M4 × 14, Black	1
63	122.210003.01	Plug, Control Box	1
64	5.1330.014	Sheath, Wire	1
65	122.210003.03	Plug, End Cover	1
66	100403.21.10	Wire Assembly	1
67	100403.21	Control Panel Assembly, Complete 100403	1

Engine Parts Diagram

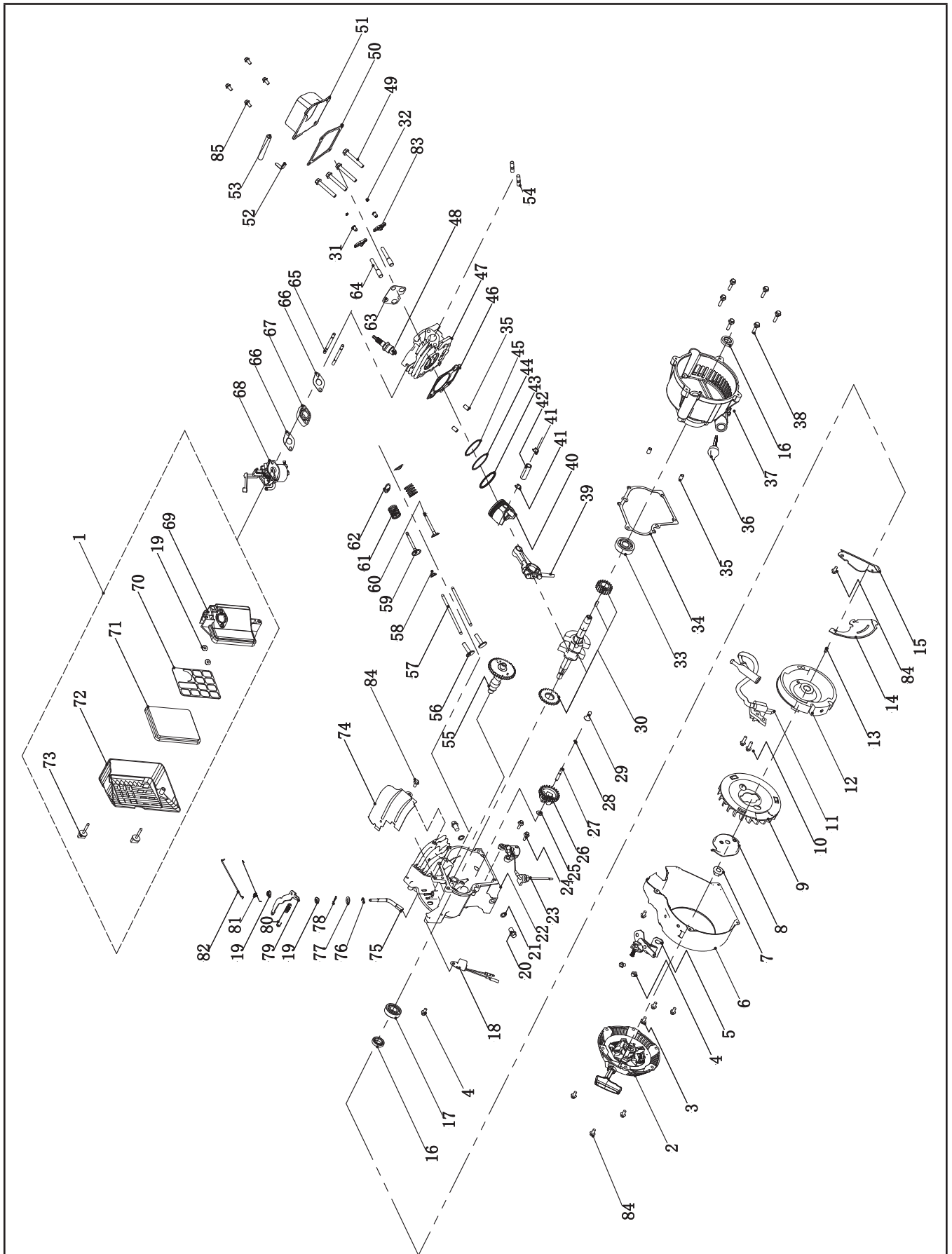

Engine Parts List

#	Part Number	Description	Qty.
1	12.091000.01	Air Cleaner Assembly	1
2	12.061000.03.48	Recoil Assembly	1
3	1.16674.0612	Flange Bolt M6 × 12	4
4	1.5789.0608	Flange Bolt M6 × 8	3
5	12.111000.01	Control Assembly	1
6	12.080100.00.48	Fan Cover, Yellow	1
7	1.6177.2.12	Flange Nut M12	1
8	12.060001.00	Pulley Starter	1
9	12.080001.00	Cooling Fan	1
10	1.16674.0620	Flange Bolt M6 × 20	2
11	12.123000.02	Ignition Coil, Silicon Rubber	1
12	15.120100.00	Flywheel	1
13	2.14.016	Woodruff Key 5 × 6.5 × 16	1
14	12.080014.00	Air Guide Board, Back	1
15	12.080014.01	Air Guide Board, Front	1
16	2.11.009	Oil Seal Ø17 × Ø30 × 6	2
17	1.276.6203	Bearing 6203	1
18	21.120400.00	Diode Assembly	1
19	1.6177.06	Nut M6, Flange	4
20	2.08.037	Bolt M10 × 1.25 × 25, Drain	2
21	2.03.016	Washer, Ø10 × Ø16 × 1.5, Drain Bolt	2
22	12.030100.01	Crankcase	1
23	12.127000.02	Oil Level Sensor	1
24	1.16674.0616	Flange Bolt M6 × 16	2
25	2.03.020.1	Washer, Ø6.2 × Ø15 × 0.5, Black	1
26	12.110100.00	Gear, Governor	1
27	12.110013.00	Shaft, Governor Gear	1
28	21.110011.00	Clip, Governor Gear	1
29	12.110012.00	Bushing, Governor Gear	1
30	12.050100.04	Crankshaft	1
31	21.040020.00	Screw, Valve Adjustment	2
32	21.040021.00	Nut M6 × 0.5, Lock	2
33	1.276.6303	Bearing 6303	1
34	12.030008.01	Gasket, Crankcase Cover	1
35	2.04.002	Dowel Pin, Ø8 × 14	4

#	Part Number	Description	Qty.
36	15.031000.00.48	Oil Dipstick Assembly, Yellow	1
37	15.030007.00	Cover, Crankcase	1
38	1.5789.0625.0.8	Flange Bolt M6 × 25	6
39	12.050200.00	Connecting Rod	1
40	12.050005.02	Piston	1
41	2.09.005	Circlip Ø16 × Ø1	2
42	12.050003.01	Pin, Piston	1
43	11.050303.00	Ring, Oil	1
44	11.050302.00	Ring, Second Piston	1
45	11.050301.00	Ring, First Piston	1
46	12.030009.00	Gasket, Cylinder Head	1
47	15.010100.00	Cylinder Head	1
48	2.15.005(E6RTC)	Spark Plug E6RTC	1
49	1.5789.0855	Flange Bolt M8 × 55	4
50	21.020002.00	Gasket, Cylinder Head Cover	1
51	15.021000.00	Cover, Cylinder Head	1
52	15.020007.00	Baffle, Line	1
53	15.020001.00	Breather Tube	1
54	2.01.010	Stud Bolt M8 × 35	2
55	12.040100.02	Camshaft	1
56	15.040013.00	Lifter, Valve	2
57	15.040005.00	Push Rod	2
58	23.040017.00	Oil Seal, Valve	1
59	12.040002.00	Valve, Intake	1
60	12.040006.00	Valve, Exhaust	1
61	12.040003.00	Spring, Valve	2
62	12.040014.00	Retainer, Valve Spring	2
63	15.040004.00	Guide Plate, Push Rod	1
64	83.040010.01	Bolt, Rocker Arm	2
65	2.01.019	Stud Bolt M6 × 89	2
66	12.130002.01	Gasket, Insulator	2
67	12.130001.00	Insulator, Carburetor	1
68	12.131000.01	Carburetor, Generator, 79cc	1
	12.131000.02	Carburetor, Generator, 79cc	
69	12.091100.00	Base, Air Cleaner	1
70	12.091001.00	Separator, Air Cleaner	1
71	12.091003.00	Element, Air Cleaner	1
72	12.091200.00	Cover, Air Cleaner	1
73	12.091500.00	Bolt, Air Cleaner	2
74	15.080300.00	Air Guide, Upper	1

#	Part Number	Description	Qty.
75	12.110001.00	Shaft, Governor Arm	1
76	1.896.06	Circlip Ø6	1
77	2.03.019	Washer, Ø8.2 × Ø17 × 0.8	1
78	12.110008.00	Pin, Shaft	1
79	12.110003.00	Arm, Governor	1
80	12.110007.21	Spring, Governor	1
81	12.110005.00	Spring, Throttle Return	1
82	12.110006.00	Rod, Governor	1
83	15.040009.00	Rocker Arm	2
84	1.5789.0612	Flange Bolt M6 × 12	5
85	1.5789.0615	Flange Bolt M6 × 15	4

Wiring Diagram

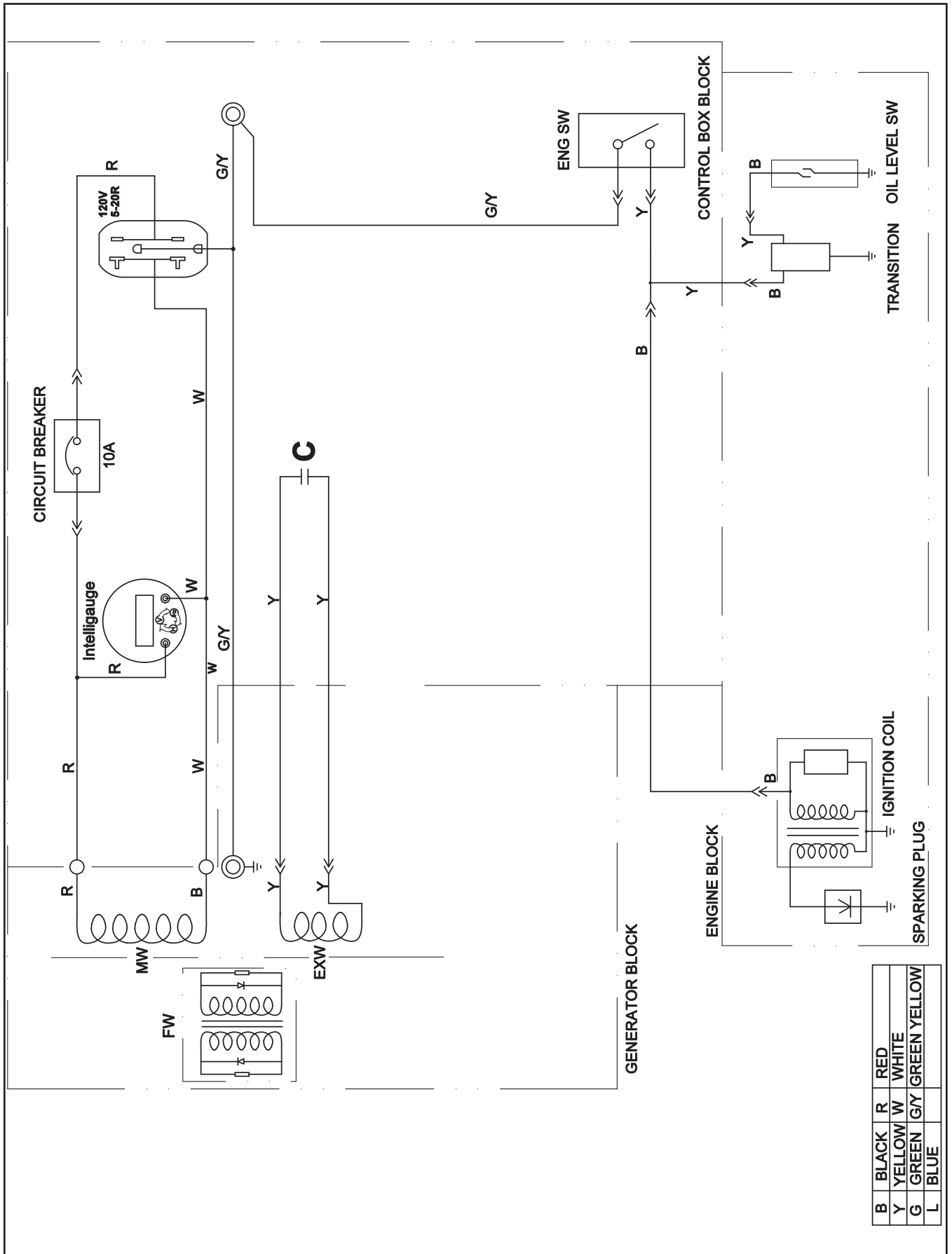

TROUBLESHOOTING

Problem	Cause	Solution
Generator will not start.	No fuel.	Add fuel.
	Faulty spark plug.	Replace spark plug.
	Unit loaded during start up.	Remove load from unit.
Generator will not start; Generator starts but runs roughly.	Low oil level.	Fill crankcase to the proper level. Place generator on a flat, level surface.
	Choke in the wrong position.	Adjust choke.
	Spark plug wire loose.	Attach wire to spark plug.
Generator shuts down during operation.	Out of fuel.	Fill fuel tank.
	Low oil level.	Fill crankcase to the proper level. Place generator on a flat, level surface.
Generator cannot supply enough power or overheating.	Generator is overloaded.	Review load and adjust. See "Connecting Electrical Loads."
	Insufficient ventilation.	Check for air restriction. Move to a well ventilated area.
No AC output.	Cable not properly connected.	Check all connections.
	Connected device is defective.	Replace defective device.
	Circuit breaker is open.	Reset circuit breaker.
	Faulty brush assembly.	Replace brush assembly (Service Center).
	Faulty AVR (auto voltage regulator).	Replace AVR (Service Center).
	Loose wiring.	Inspect and tighten wiring connections.
	Other.	Contact the help line.
Generator gallops.	Engine governor defective.	Contact the help line.
Repeated circuit breaker tripping.	Overload.	Review load and adjust. See "Connecting Electrical Loads."
	Faulty cords or device.	Check for damaged, bare or frayed wires. Replace defective device.

For further technical support:

Technical Support Team
 Mon-Fri 8:30 AM-5:00 PM (PST/PDT)
 Toll Free 1-877-338-0999
support@championpowerequipment.com

WARRANTY

WARRANTY*

CHAMPION POWER EQUIPMENT
3 YEAR LIMITED WARRANTY

Warranty Qualifications

Champion Power Equipment (CPE) will register this warranty upon receipt of your Warranty Registration Card and a copy of your sales receipt from one of CPE's retail locations as proof of purchase. Please submit your warranty registration and your proof of purchase within ten (10) days of the date of purchase.

Repair/Replacement Warranty

CPE warrants to the original purchaser that the mechanical and electrical components will be free of defects in material and workmanship for a period of three years (parts and labor) from the original date of purchase and 270 days (parts and labor) for commercial and industrial use. Transportation charges on product submitted for repair or replacement under this warranty are the sole responsibility of the purchaser. This warranty only applies to the original purchaser and is not transferable.

Do Not Return The Unit To The Place Of Purchase

Contact CPE's Technical Service and CPE will troubleshoot any issue via phone or e-mail. If the problem is not corrected by this method, CPE will, at its option, authorize evaluation, repair or replacement of the defective part or component at a CPE Service Center. CPE will provide you with a case number for warranty service. Please keep it for future reference. Repairs or replacements without prior authorization, or at an unauthorized repair facility, will not be covered by this warranty.

Warranty Exclusions

This warranty does not cover the following repairs and equipment:

Normal Wear

Products with mechanical and electrical components need periodic parts and service to perform well. This warranty does not cover repair when normal use has exhausted the life of a part or the equipment as a whole.

Installation, Use and Maintenance

This warranty will not apply to parts and/or labor if the product is deemed to have been misused, neglected, involved in an accident, abused, loaded beyond the product's limits, modified, installed improperly or connected incorrectly to any electrical component. Normal maintenance is not covered by this warranty and is not required to be performed at a facility or by a person authorized by CPE.

Other Exclusions

This warranty excludes:

- Cosmetic defects such as paint, decals, etc.
- Wear items such as filter elements, o-rings, etc.
- Accessory parts such as starting batteries, and storage covers.
- Failures due to acts of God and other force majeure events beyond the manufacturer's control.
- Problems caused by parts that are not original Champion Power Equipment parts.

When applicable, this warranty does not apply to products used for prime power in place of a utility.

Limits of Implied Warranty and Consequential Damage

Champion Power Equipment disclaims any obligation to cover any loss of time, use of this product, freight, or any incidental or consequential claim by anyone from using this product. THIS WARRANTY AND THE ATTACHED U.S. EPA, CARB and/or ECCC EMISSION CONTROL SYSTEM WARRANTIES (WHEN APPLICABLE) ARE IN LIEU OF ALL OTHER WARRANTIES, EXPRESS OR IMPLIED, INCLUDING WARRANTIES OF MERCHANTABILITY OR FITNESS FOR A PARTICULAR PURPOSE.

A unit provided as an exchange will be subject to the warranty of the original unit. The length of the warranty governing the exchanged unit will remain calculated by reference to the purchase date of the original unit.

This warranty gives you certain legal rights which may change from state to state or province to province. Your state or province may also have other rights you may be entitled to that are not listed within this warranty.

Contact Information

Address

Champion Power Equipment, Inc.
Customer Service
12039 Smith Ave.
Santa Fe Springs, CA 90670 USA
www.championpowerequipment.com

Customer Service

Mon – Fri 8:30 AM – 5:00 PM (PST/PDT)
Toll Free: 1-877-338-0999
info@championpowerequipment.com
Fax no.: 1-562-236-9429

Technical Service

Mon – Fri 8:30 AM – 5:00 PM (PST/PDT)
Toll Free: 1-877-338-0999
tech@championpowerequipment.com
24/7 Tech Support: 1-562-204-1188

*Except as otherwise stipulated in any of the following enclosed Emission Control System Warranties (when applicable) for the Emission Control System: U.S. Environment Protection Agency (EPA), California Air Resources Board (CARB) and/or Environment and Climate Change Canada (ECCC). Whichever warranty applies for the longer period, either this 3 year limited warranty or the applicable Emission Control System Warranty, shall supersede the other.

**Champion Power Equipment, Inc. (CPE),
The United States Environment Protection Agency (U.S. EPA.) and the California Air Resources Board (CARB)
Emission Control System Warranty**

Your Champion Power Equipment (CPE) engine complies with both the U.S. EPA and state of California Air Resources Board (CARB) emission regulations.

YOUR WARRANTY RIGHTS AND OBLIGATIONS:

The US EPA, California Air Resources Board, and CPE are pleased to explain the Federal and California Emission Control Systems Warranty on your 2017 small off-road engine and engine powered equipment. In California, new, small off-road engines and new equipment that use small off-engines must be designed, built and equipped to meet the State's stringent anti smog standards. In the other states, new engines and equipment must be designed, built and equipped, at the time of sale, to meet U.S. EPA regulations for small non-road engines. CPE warrants the emission control system on your small off-road engine and equipment for the period of time listed below, provided there has been no abuse, neglect, unapproved modification, or improper maintenance of your equipment.

Your emission control system may include parts such as the carburetor, fuel-injection system, the ignition system, catalytic converter and fuel lines. Also included may be hoses, belts, connectors and other emission related assemblies. Where a warrantable condition exists, CPE will repair your small off-road engine at no cost to you including diagnosis, parts and labor. For engines less than or equal to 80cc, only the fuel tank and fuel line is subject to the evaporative emission control warranty requirements of this section.

MANUFACTURER'S EMISSION CONTROL SYSTEM WARRANTY COVERAGE:

This emission control system is warranted for two years, subject to provisions set forth below. If, during the warranty period, emission related part on your engine is defective in materials or workmanship, the part will be repaired or replaced by CPE.

OWNER WARRANTY RESPONSIBILITIES:

As the small off-road engine owner, you are responsible for the performance of the required maintenance listed in your Owner's Manual. CPE recommends that you retain all your receipts covering maintenance on your small off-road engine, but CPE cannot deny warranty solely for the lack of receipts or for your failure to ensure the performance of all scheduled maintenance.

As the small off-road engine owner, you should however be aware that CPE may deny you warranty coverage if your small, off-road engine or a part has failed due to abuse, neglect, improper maintenance or unapproved modifications.

You are responsible for presenting your small off-road engine to an Authorized CPE service outlet or alternate service outlet as described in (3)(f.) below, CPE dealer or CPE, Santa Fe Springs, Ca. as soon as a problem exists. The warranty repairs should be completed in a reasonable amount of time, not to exceed 30 days.

If you have any questions regarding your warranty rights and responsibilities, you should contact:

Champion Power Equipment, Inc.
Customer Service
12039 Smith Ave.
Santa Fe Springs, CA 90670
1-877-338-0999
tech@championpowerequipment.com

EMISSION CONTROL SYSTEM WARRANTY

The following are specific provisions relative to your Emission Control System (ECS) Warranty Coverage.

1. APPLICABILITY: This warranty shall apply to 1995 and later model year California small off-road engines (for other states, 1997 and later model year engines). The ECS Warranty Period shall begin on the date the new engine or equipment is delivered to its original, end-use purchaser, and shall continue for 24 consecutive months thereafter.

2. GENERAL EMISSIONS WARRANTY COVERAGE

CPE warrants to the original, end-use purchaser of the new engine or equipment and to each subsequent purchaser that each of its small off-road engines is:

a. Designed, built and equipped so as to conform to U.S. EPA emissions standards for spark-ignited engines at or below 19 kilowatts and all applicable regulations adopted by the California Air Resources Board and

b. Free from defects in materials and workmanship that cause the failure of a warranted part to be identical in all material respects to the part as described in the engine manufacturer's application for certification for a period of two years.

3. THE WARRANTY ON EMISSION-RELATED PARTS WILL BE INTERPRETED AS FOLLOWS:

a. Any warranted part that is not scheduled for replacement as required maintenance in the Owners Manual shall be warranted for the ECS Warranty Period. If any such part fails during the ECS Warranty Period, it shall be repaired or replaced by CPE according to Subsection "d" below. Any such part repaired or replaced under the ECS Warranty shall be warranted for any remainder of the ECS Warranty Period.

b. Any warranted, emissions-related part which is scheduled only for regular inspection as specified in the Owners Manual shall be warranted for the ECS Warranty Period. A statement in such written instructions to the effect of "repair or replace as necessary", shall not reduce the ECS Warranty Period. Any such part repaired or replaced under the ECS Warranty shall be warranted for the remainder of the ECS Warranty Period.

c. Any warranted, emissions-related part which is scheduled for replacement as required maintenance in the Owner's Manual shall be warranted for the period of time prior to the first scheduled replacement point for that part. If the part fails prior to the first scheduled replacement, the part shall be repaired or replaced by CPE according to Subsection "d" below. Any such emissions-related part repaired or replaced under the ECS Warranty, shall be warranted for the remainder of the ECS Warranty Period prior to the first scheduled replacement point for such emissions-related part.

d. Repair or replacement of any warranted, emissions-related part under this ECS Warranty shall be performed at no charge to the owner at a CPE Authorized Service Outlet.

e. The owner shall not be charged for diagnostic labor which leads to the determination that a part covered by the ECS Warranty is in fact defective, provided that such diagnostic work is performed at a CPE Authorized Service Outlet.

f. CPE shall pay for covered emissions warranty repairs at non-authorized service outlets under the following circumstances:

i. The service is required in a population center with a population over 100,000 according to U.S. Census 2000 without a CPE Authorized Service Outlet AND

ii. The service is required more than 100 miles from a CPE Authorized Service Outlet. The 100 mile limitation does not apply in the following states: Alaska, Arizona, Colorado, Hawaii, Idaho, Montana, Nebraska, Nevada, New Mexico, Oregon, Texas, Utah and Wyoming.

g. CPE shall be liable for damages to other original engine components or approved modifications proximately caused by a failure under warranty of an emission-related part covered by the ECS Warranty.

h. Throughout the ECS Warranty Period, CPE shall maintain a supply of warranted emission-related parts sufficient to meet the expected demand for such emission-related parts.

i. Any CPE Authorized and approved emission-related replacement part may be used in the performance of any ECS Warranty maintenance or repair and will be provided without charge to the owner. Such use shall not reduce CPE's warranty obligation.

j. Unapproved add-on or modified parts may not be used to modify or repair a CPE engine. Such use voids this ECS Warranty and shall be sufficient grounds for disallowing an ECS Warranty claim. CPE shall not be liable hereunder for failures of any warranted parts of a CPE engine caused by the use of such an unapproved add-on or modified part.

EMISSION-RELATED PARTS INCLUDE THE FOLLOWING: (using those portions of the list applicable to the engine)

Systems covered by this warranty	Parts Description
Fuel Metering System	Fuel regulator, Carburetor and internal parts
Air Induction System	Air cleaner, Intake manifold
Ignition System	Spark plug and parts, Magneto ignition system
Exhaust System	Exhaust manifold, catalytic converter
Miscellaneous Parts	Tubing, Fittings, Seals, Gaskets, and Clamps associated with these listed systems.
Evaporative Emissions	Fuel Tank, Fuel Cap, Fuel Line, Fuel Line Fittings, Clamps, Pressure Relief Valves, Control Valves, Control Solenoids, Electronic Controls, Vacuum Control Diaphragms, Control Cables, Control Linkages, Purge Valves, Vapor Hoses, Liquid/Vapor Separator, Carbon Canister, Canister Mounting Brackets, Carburetor Purge Port Connector

TO OBTAIN WARRANTY SERVICE:

You must take your CPE engine or the product on which it is installed, along with your warranty registration card or other proof of original purchase date, at your expense, to any Champion Power Equipment dealer who is authorized by Champion Power Equipment, Inc. to sell and service that CPE product during his normal business hours. Alternate service locations defined in Section (3)(f.) above must be approved by CPE prior to service. Claims for repair or adjustment found to be caused solely by defects in material or workmanship will not be denied because the engine was not properly maintained and used.

If you have any questions regarding your warranty rights and responsibilities, or to obtain warranty service, please write or call Customer Service at Champion Power Equipment, Inc.

**Champion Power Equipment, Inc.
12039 Smith Ave.
Santa Fe Springs, CA 90670
1-877-338-0999
Attn.: Customer Service
tech@championpowerequipment.com**