

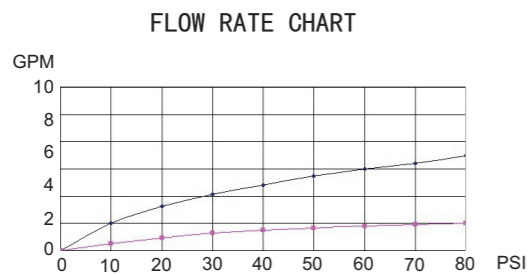

MODELS: YPH24258 SERIES

- Single Handle Pressure Balanced Tub & Shower Set
- Finishes: BN-Brushed Nickel
ORB-Oil Rubbed Bronze
PC-Polished Chrome

● STANDARDS



Warranty Information

Yosemite Home Décor Faucets products are covered by a manufacturer's limited "lifetime" warranty for manufacturing defects.

Yosemite Home Décor Faucets have been manufactured under the highest standards of quality and workmanship. Yosemite warrants to the original consumer purchaser of the faucet against defects in material and workmanship for a period of ten (10) years from date of purchase. This warranty applies only to the original owner, providing the product has been installed in accordance with our installation instructions, used as recommended and in a normal residential application. In the event of a warranty claim, the owner will be required to provide proof of purchase - save sales receipt. This warranty covers all components which make the product operational. **Yosemite Home Décor** at its option, may repair or replace the product or components necessary to restore the product to good working condition. Yosemite reserves the right to inspect the installation prior to the actual replacement of the product or component part. This warranty does not cover misuse or abuse, accidental damages, scuffs or scratches, improper installation, abnormal usage, negligence or damage caused by improper maintenance or cleaning.

** Normal wear of parts is excluded from the warranty. Damage caused by impurities or acts beyond our control are not covered. Any replacement excludes transportation and any labor re-installation costs.

This warranty does not allow recovery of incidental or consequential damages such as loss of use, delay, property damage or other consequential damage, and **Yosemite Home Décor** accepts no liability for such damages.

The **Yosemite Home Décor** warranty is limited to the above conditions and to the warranty period specified herein and is exclusive. Yosemite Home Décor disclaims all other warranties, expressed or implied, including implied warranties of merchantability and/or fitness for a particular purpose.

Pre- Installation reminders

Check with the local plumbing code requirements before installation

Gather necessary tools needed for installation. Some may not be needed depending on the model of the faucet being installed.

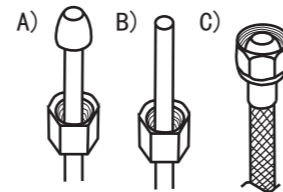

(A) 3/8" supply lines with coupling knots;
(B) 3/8" supply lines with interior connectors;
(C) 1/2" IPS faucet connector.



SAFETY GLASSES



FLASHLIGHT



ADJUSTABLE WRENCH



CHANNEL LOCKS

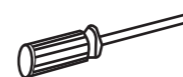

SCREWDRIVER

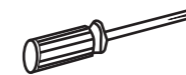

PLIERS



PIPE TAPE



PLUMBERS PUTTY

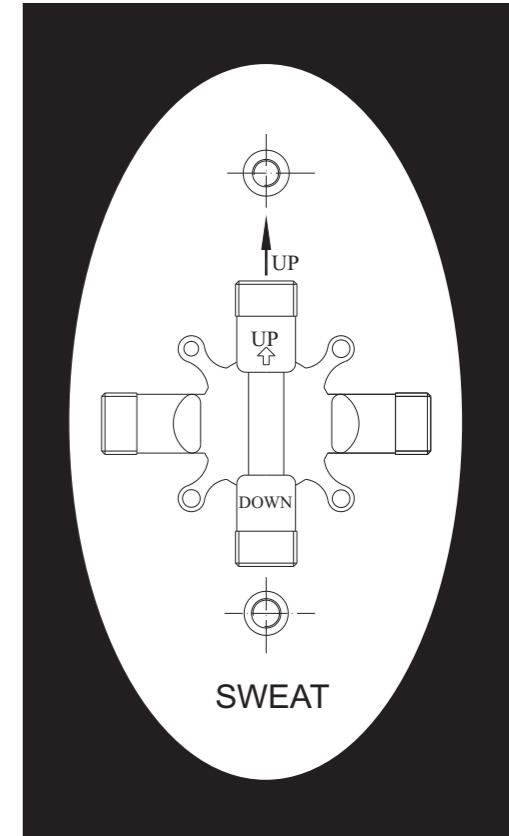

1) Turn off water supplies

2) Install valve, make sure "up" outlet is facing up. Connect water supplies to valve. (Hot water to left side and cold water to right side.) Use right amount Teflon Tape on all threaded connections.

Maintenance:

Simply rinse the surface with clear water or mild liquid detergents (if necessary). Dry the faucet with a clean soft cotton cloth. Do not use any cleaning agents containing acid, polish abrasives, or harsh cleaners.

Installation

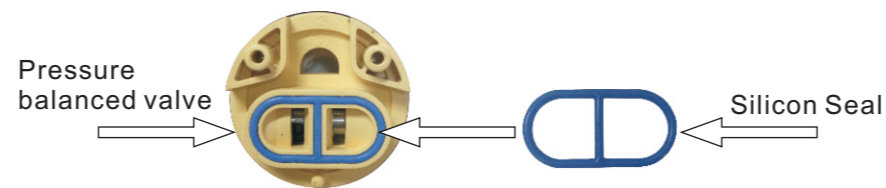
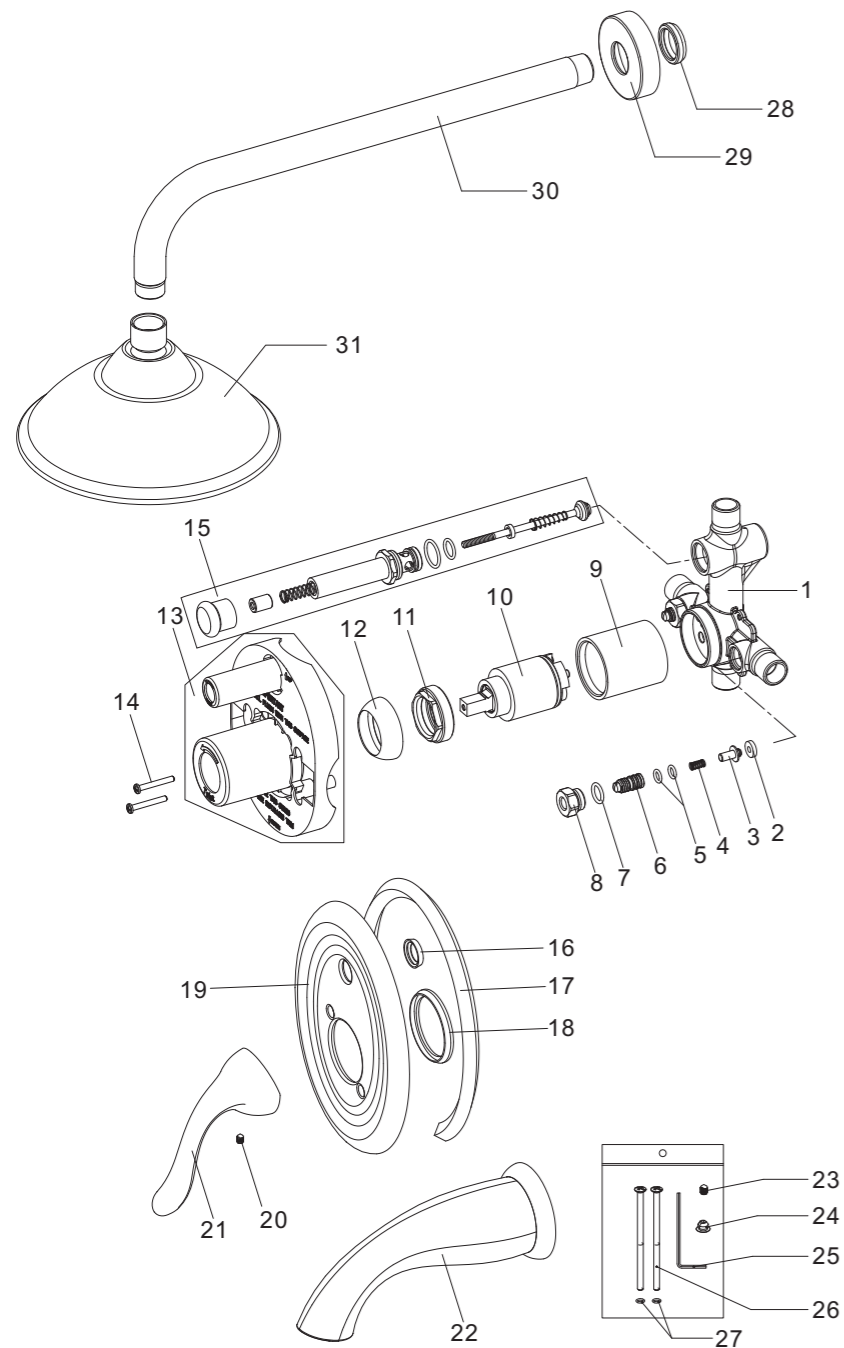

When connect with "CxM Adapter or CxF Adapter, wrap the threads with right amount of Teflon Tape. (Wrap 20cycles)
Note: connected without Teflon Tape may cause leakage.

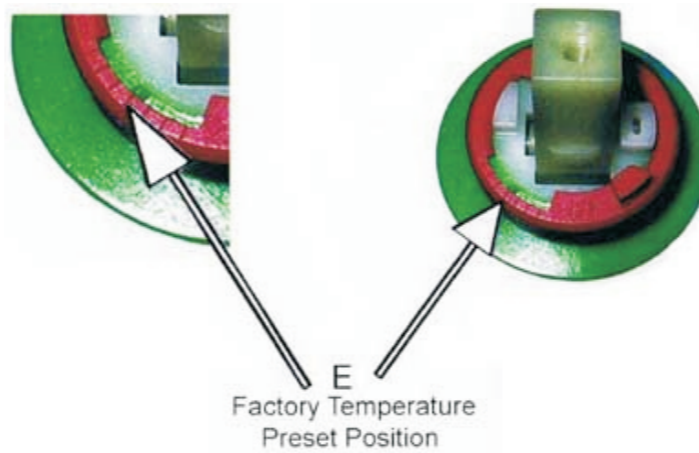

Important Notes:

Before reinstall the Pressure balanced valve make sure temperature ring (E) is on the factory temperature preset position. Soldering without removing ceramic cartridge, pressure balanced valve and integral stop will void the factory warranty.

- 1) Connect spout and shower unit, Put a 1/2" spout if there is no connection to either one. Attach shower head only after flushing the system with both hot and cold for 1 minute.
- 2) After all connection has been made. Attach handle and test system. Check all connection and valve for any leaks.
- 3) Test water pressure on full hot and cold. If water pressure is unbalanced, use the stud on the valve to adjust.

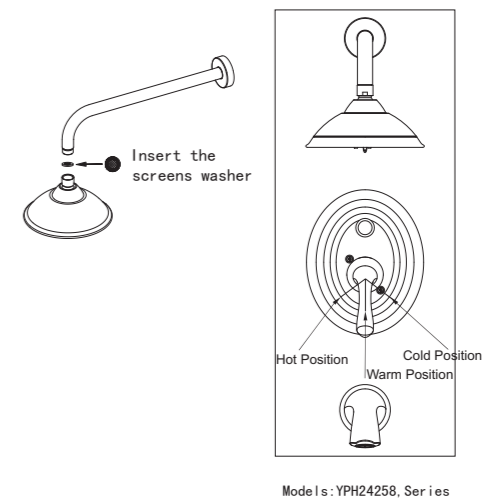
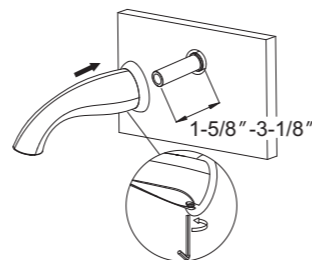

Models: YPH24258, Series

- 1) Remove handle and attach faceplate with supplied screws.
- 2) Attach handle and fasten, test system again.

Pressure Balance Valve Application APPLICATION

A pressure balance valve was designed to be adjusted incoming hot or cold water pressure and compensates for fluctuations to keep shower temperatures constant and comfortable. When the inlet hot water is 120°F-180°F and inlet cold water is 39°F to 84°F. The balance valve can compensate the temperature of outlet water from normal to 106°F and there is a component that can limit the hottest position setting. Tub/shower faucets have this pressure balancing feature to prevent shower shock.

FEATURES:

1. passed the certificate of anti-scaled standard ASME A112.18.1M U.S.A. And CSA
2. Our balance valve have applied the patent of USA, China and Taiwan. The other countries patent are pending.
3. The balance valve are component of #303 stainless steel, precise ceramic and high tech plastic material. Therefore the parallel and concentricity keep well. Easy to installation, operation smoothly and quality stability.
4. Temperature limit setting our pressure balance valve can be adjusted via a component to the temperature limit setting. So that the discharge temperature will not exceed 120°F.
5. When the inlet water pressure change up to 50% or cold water pressure raise up to 50%, the temperature of outlet still can maintain within $\pm 35.2^\circ\text{F}$ to ensure shower safety to prevent hot burn.
6. When the temperature of outlet water is $100^\circ\text{F} \pm 2^\circ\text{F}$, outlet cold water flow rate decrease, the outlet water still can be adjusted within 120°F in 2 second. In other words, the outlet hot water can be decreased flow rate to 1.9L/min (1.5GPM) to free from hot burn.
7. The pressure balance valve we designed can be said as two in one valve for installation either in the front side or in the opposite direction of the same wall and the same water supply pipes.

NOTE:

1. Make sure the proper position of hot/cold water supply pipes before install the valve
2. The torque suggest condition:

100-120 kgf.com (for mode YP57TS, YP57SO)

3. The hot/cold water supply condition
hot water supply 120°F-180°F
cold water supply 39°F-85°F
4. When finish assembly, make sure it is cold water, warm water, hot water incoming when you turn on the faucet.
5. If the water contains contaminants a lot, it's required in a period and check the valve to ensure functionally normal and working properly. The inspection times depend on the amount of contaminants in the water.
6. The valve must be set by professional installer to ensure safety. Any improper installation will raise the discharge temperature and may get hot burns.

- 1) Before soldering, remove pressure balanced valve (15, 14, 13, 12, 11) remove integral (8, 7, 6, 5, 4, 3, 2) from shower body.
- 2) After cool down from soldering, replace Integral (2, 3, 4, 5, 6, 7, 8) in order back to shower body, use flat head screwdriver to turn the Studs (6) to "Close" position, install pressure balanced valve and ceramic cartridge, turn on water supplies, check connection for leak, turn Studs (6) slowly to "Semi On" position, flush the system with both hot and cold water for 1 minute. Turn off water supplies, turn Studs (6) to "full open" position,
- 3) Replace pressure balanced valve back to shower body, make sure silicon seals (A) are on the right position, installed without silicon seals may cause leakage.

