

File #E37116

Electric Baseboard Heaters

2500 & C2500 Series

Installation, Operation & Maintenance Instructions

Dear Owner,

Congratulations! Thank you for purchasing this new heater manufactured by Marley Engineered Products. You have made a wise investment selecting the highest quality product in the heating industry. Please carefully read the installation and maintenance instructions shown in this manual. You should enjoy years of efficient heating comfort with this product from Marley Engineered Products... the industry's leader in design, manufacturing, quality and service.

*... The Employees of
Marley Engineered Products*

WARNING

Read Carefully - This Instruction Sheet contains vital information for the proper installation, use, and efficient operation of the heater. Carefully read the manual before installation, operation, or cleaning of the heater. Failure to adhere to the instructions could result in fire, electric shock, death, serious personal injury, or property damage. Save these instructions and review frequently for continuing safe operation and instructing future users.

CAUTION - TO REDUCE RISK OF FIRE AND ELECTRIC SHOCK OR INJURY TO PERSONS, OBSERVE THE FOLLOWING:

1. Keep all electrical cords, foam filled articles, drapes, bedding, and other household furnishings away from contact with heater. It is recommended all items be kept a minimum of six (6") inches (152mm) from heater.
2. Do not install baseboard heater below electrical convenience receptacles (outlets).
3. Do not install upside down or in any position other than as shown in this manual.
4. Do not install baseboard heater against vinyl wallpaper, paperboard or low density fiberboard surface. Do not install vinyl drapes or vinyl blinds above heater.
5. Do not recess heater in wall.
6. The installation must comply with applicable Local and National Electrical Codes and utility requirements.
7. Do not remove or by-pass the safety limit (see Figure 4).
8. To reduce the risk of fire, do not store or use gasoline or other flammable vapors and liquids in the vicinity of the heater.
9. Personal injury or death could result from electric shock. Disconnect all power to heater at main panel before attempting to install or service this heater.
10. Supply voltage must be the same as heater voltage. Check heater nameplate and supply voltage before energizing.
11. When using RSA Transformer Relay Accessory, supply wiring must be suitable for 90°C.

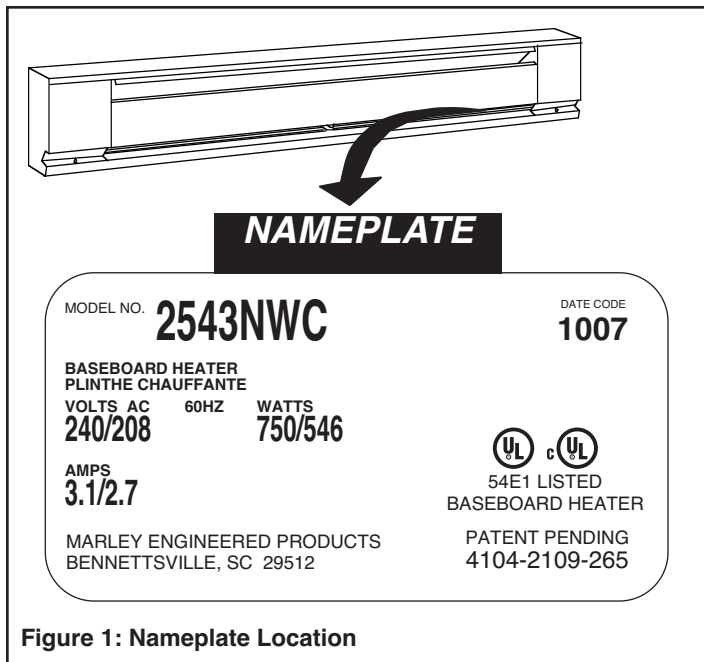

Figure 1: Nameplate Location

Table 1

Total Amps	Minimum AWG. Wire Size (Copper)	Circuit Breaker or Fuse Size
0 thru 12	#14	15 amp
12.1 thru 16	#12	20 amp
16.1 thru 24	#10	30 amp

Table 2: Net Volumes of Wiring Compartment

DESCRIPTION	CUBIC INCHES	CUBIC CM
Heater Only (Each Wiring Compartment)	14.96	241
Heater W/SP Thermostat	11.18	180
Heater W/DP Thermostat	11.18	180
Heater W/Heat-Cool Switch Receptacle	9.51	153
Heater W/Duplex Receptacle	11.18	180
Heater W/DP Disconnect Switch	11.18	180
Heater W/Power Relay	10.76	174
Heater W/Transformer Relay	2.93	47

GENERAL

This heater is designed to provide years of efficient, trouble free operation as a primary or supplementary heat source for comfort heating in residential and commercial applications. Baseboard heaters must be thermostatically controlled for efficient, safe operation. A thermostat is not provided with this heater. However, a single or double pole thermostat accessory is available for installation into this heater at your place of purchase, or the heater may be connected to any suitable wall mounted thermostat that will meet the electrical load requirements. Installation or use of this product in a manner not described herein will void the warranty and could result in injury, damage to property, or permanent damage to heater.

UNPACKING HEATER

Check heater to make sure it has not been damaged in shipping. Do not install or attempt to operate the heater if damaged. Return to place of purchase or file claim with freight carrier.

Notice to owners: Certain fabrics discolor in time from indirect sunlight and normal room temperature - mostly organic and synthetic material. They will discolor more rapidly when exposed to direct sunlight and warm currents. Hang drapes to provide mini-

um of 2 in.(51mm) air space between heater front and nearest drape fold as shown in Example 1 Figure 2, or 6 in.(153mm) air-space between top of heater and bottom of drapes as shown in Example 2, Figure 2. Allow minimum clearance of 1 in. (26mm) from drapes to ceiling and to top of floor covering to permit air circulation as shown in Example 1, Figure 2.

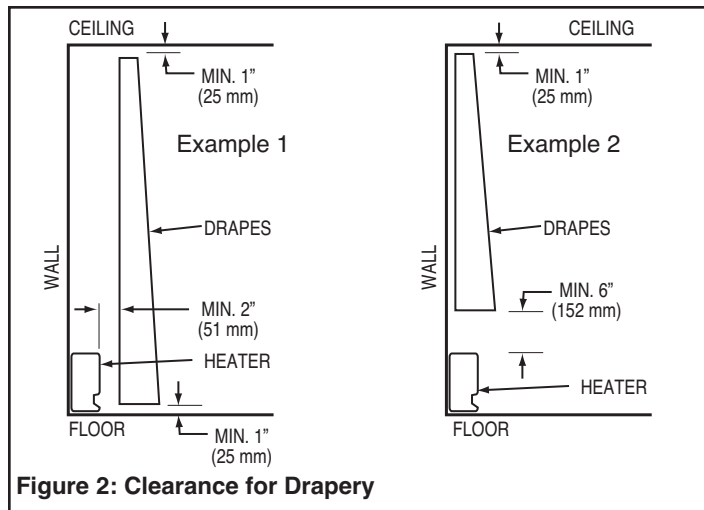
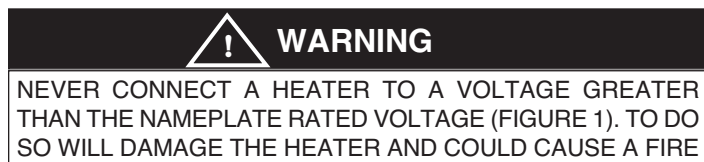

Figure 2: Clearance for Drapery

INSTALLATION

Note: Check heater nameplate for electrical ratings before beginning. Make sure voltage and amperage ratings on the heater nameplate match those of the power supply and any accessories used, see Figure 1 and Table 1.



Floors & Carpeting: Heaters may be mounted directly on any floor surface, including carpeting. Where wall-to-wall carpets are installed after the baseboard installation, the carpeting can be run up to the front and around the heater body, providing it does not obstruct air flow. (Maximum 3/4" (19mm) thick).

1. Remove wiring compartment cover at end of heater where power supply cable is to enter (Figure 3). Determine desired mounting location, position heater to wall and mark wall (or floor) at location where power supply is to enter heater.

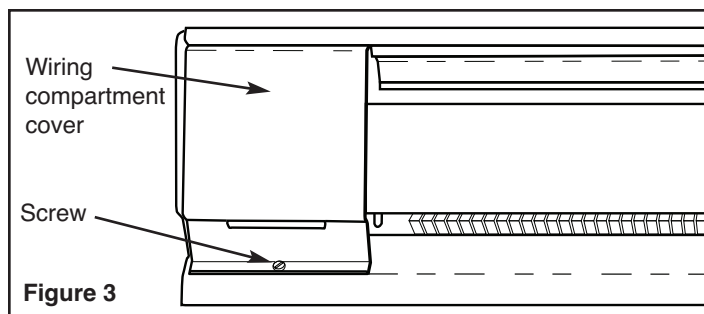

Figure 3

NOTE: Make sure the caution label with the word "TOP" is at the top of the heater. For most efficient operation locate heaters along outside wall under windows. Position heater so it can be secured to wall stud. Power cable must enter heater through built in cable clamp or one of the knockouts provided in wiring compartment.

2. Drill hole in wall (or floor) at desired location for power supply entry. Install power supply wiring to heater and thermostat location as determined by thermostat option selected. Allow approximately 10 to 12in (254mm to 305mm) of wire at heater for connections.
3. If any accessories are to be used with this heater, refer to installation instructions provided with the accessory for proper installation and wiring. Visit www.marleymep.com for instructions on some common accessories.
4. Wireway Cover - Commercial Baseboard Only
 - a. The wireway cover is a factory installed feature of Marley commercial baseboard heaters. Two cables or four individual conductors plus two ground wires may be routed through the wireway. Refer to page 2, Table 1 for wire size and current loads.
 - b. To gain access to wireway, lay heater face down and remove the screws holding the wireway from the back of the heater. Remove the knockouts in the channel areas of both terminal boxes.
 - c. Insert the plastic bushings from the parts kit (in wiring compartment) in the knockout holes.
 - d. Wire heater according to wiring diagrams in Figure 5. Reattach the wireway cover using the screws.

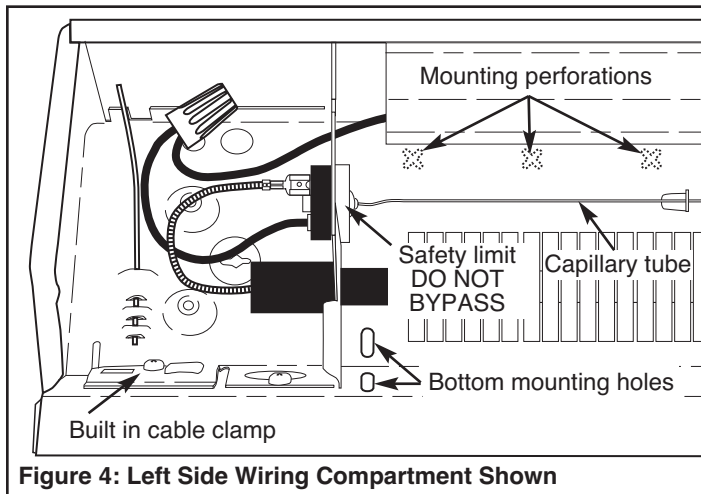

Figure 4: Left Side Wiring Compartment Shown

5. Loosen screw in built-in cable clamp (Figure 4) or remove desired knockout from heater wiring compartment. Install power cable into wiring compartment allowing at least 6 in (153mm) of cable for connection to heater. To install two power cables using the built-in cable clamp, bend tab covering second hole up and back to rear wall of wiring compartment. If built-in cable clamp is not used, install approved cable restraint (not included) in desired knockout.
6. Position heater at desired location and attach to wall using wood screws or appropriate hardware.

Note: cross stamped mounting perforations are provided in back of heater enclosure above heating element at mounting screw locations, see Figure 4.

Locate studs and drive screws into studs where possible. For heaters up to 6 feet (1.8 m) in length, one screw at each end is adequate. For longer units, an additional screw in center is required. Tighten screws and then loosen screws at least ¼ turn to allow heater to expand and contract during use. If unit is mounted above floor, two additional mounting holes are supplied at each end below the heating element (see Figure 4). Install an additional screw at each end for stability making sure to loosen each screw at least ¼ turn.



CAUTION

WHEN USING BOTTOM MOUNTING HOLES, (TO PREVENT A POSSIBLE SHOCK OR FIRE HAZARD,) MAKE SURE YOU DO NOT DRIVE THE SCREWS THROUGH OR DAMAGE THE POWER SUPPLY WIRE.

7. Connect the supply cable grounding wire to the bare copper pigtail in wiring compartment.
8. After making sure the electrical power coming to the heater is turned off at main switch panel follow the desired wiring diagram, as shown in Figure 5, to connect the power supply to the heater using approved wire nuts.



WARNING

TO PREVENT A POSSIBLE FIRE, MAKE SURE ALL WIRE CONNECTIONS ARE TIGHT.

NOTE: When accessories are installed, use wiring diagram supplied with the accessory.

9. If front cover was removed, reinstall by hooking the top edge on the support bracket(s). Then push down to latch onto the support bracket(s).
10. Replace wiring compartment cover.
11. Follow instructions accompanying thermostat for installation and wiring thermostat. Visit www.marleymep.com for typical thermostat wiring diagrams.

OPERATION

1. After the baseboard system has been completely installed, all thermostats should be turned to LOW or NO HEAT. Then turn on breakers. Wait 3 to 5 minutes and check to see that none of the heaters are operating. If operating, disconnect power and check wiring. If none are operating then turn thermostats to highest position and wait 3 to 5 minutes. Check to see that all heater(s) are operating. Should any not be operating, disconnect power and check wiring.
2. Allow entire system to operate steadily for 1/2 hour. This should remove oily residue from manufacturing. (Some smoking may occur).
3. Select the setting for comfort on all thermostats.

CLEANING

Because of the convection heating principle which depends on air circulation through the finned element, dust will collect between the fins. The heater should be cleaned regularly for maximum efficiency. Before cleaning be sure the heater is off and the element is cool. A vacuum cleaner with a brush attachment may be used for cleaning. The finish of the heater may be cleaned with a slightly damp rag if desired.

PAINTING

Painting of this baseboard is not necessary unless to match room decor. To paint, first rough up the exterior with steel wool. Paint only the exterior of the cabinet. Do not allow paint on the element and safety limit capillary tube (Figure 4). Use a high quality enamel paint.

Factory Wiring Shown

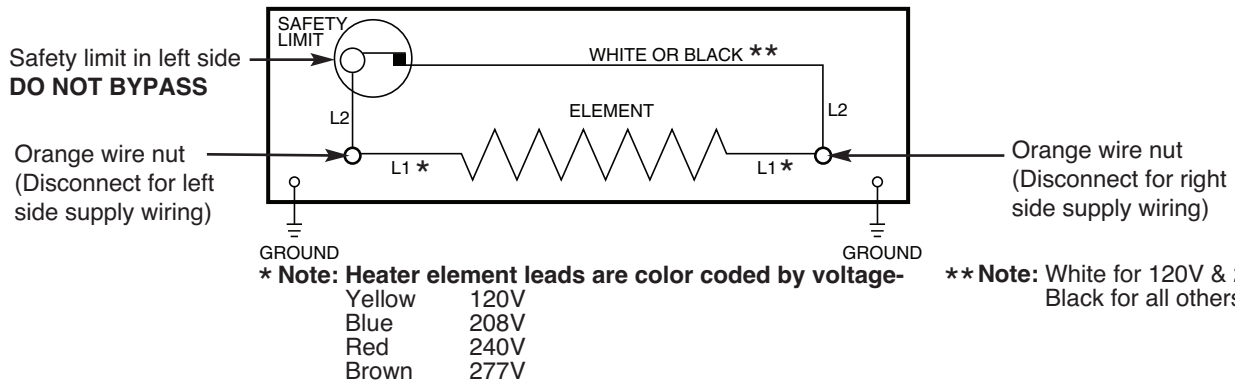

Left End Supply Wiring

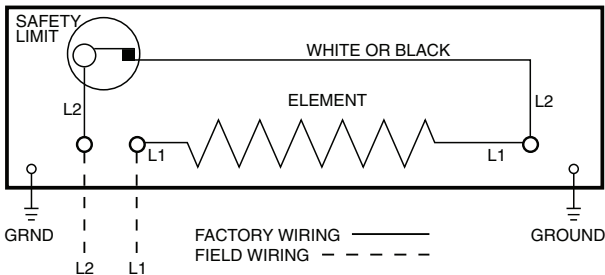

Right End Supply Wiring

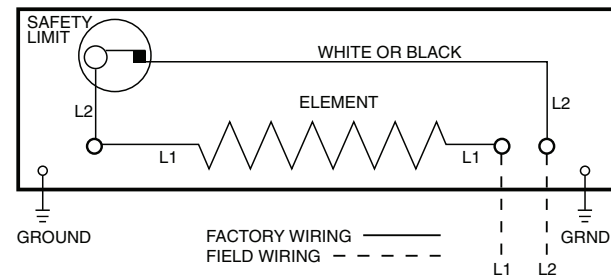

Connection For Adjacent Heaters

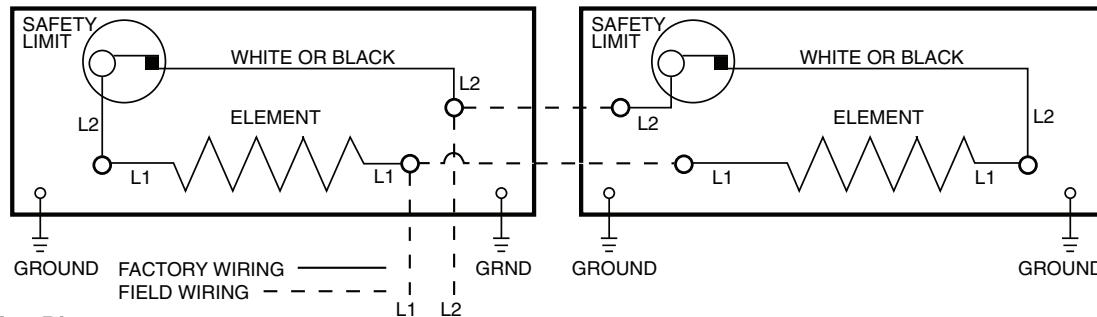

Figure 5: Wiring Diagrams

LIMITED WARRANTY

All products manufactured by Marley Engineered Products are warranted against defects in workmanship and materials for one year from date of installation, except heating elements which are warranted against defects in workmanship and materials for ten years from date of installation. This warranty does not apply to damage from accident, misuse, or alteration; nor where the connected voltage is more than 5% above the nameplate voltage; nor to equipment improperly installed or wired or maintained in violation of the product's installation instructions. All claims for warranty work must be accompanied by proof of the date of installation.

The customer shall be responsible for all costs incurred in the removal or reinstallation of products, including labor costs, and shipping costs incurred to return products to Marley Engineered Products Service Center. Within the limitations of this warranty, inoperative units should be returned to the nearest Marley authorized service center or the Marley Engineered Products Service Center, and we will repair or replace, at our option, at no charge to you with return freight paid by Marley. It is agreed that such repair or replacement is the exclusive remedy available from Marley Engineered Products.

THE ABOVE WARRANTIES ARE IN LIEU OF ALL OTHER WARRANTIES EXPRESSED OR IMPLIED, AND ALL IMPLIED WARRANTIES OF MERCHANTABILITY AND FITNESS FOR A PARTICULAR PURPOSE WHICH EXCEED THE AFORESAID EXPRESSED WARRANTIES ARE HEREBY DISCLAIMED AND EXCLUDED FROM THIS AGREEMENT. MARLEY ENGINEERED PRODUCTS SHALL NOT BE LIABLE FOR CONSEQUENTIAL DAMAGES ARISING WITH RESPECT TO THE PRODUCT, WHETHER BASED UPON NEGLIGENCE, TORT, STRICT LIABILITY, OR CONTRACT.

Some states do not allow the exclusion or limitation of incidental or consequential damages, so the above exclusion or limitation may not apply to you. This warranty gives you specific legal rights, and you may also have other rights which vary from state to state.

For the address of your nearest authorized service center, contact Marley Engineered Products in Bennettsville, SC, at 1-800-642-4328. Merchandise returned to the factory must be accompanied by a return authorization and service identification tag, both available from Marley Engineered Products. When requesting return authorization, include all catalog numbers shown on the products.

HOW TO OBTAIN WARRANTY SERVICE AND WARRANTY PARTS PLUS GENERAL INFORMATION

1. Warranty Service or Parts **1-800-642-4328**
2. Purchase Replacement Parts **1-800-654-3545**
3. General Product Information **www.marleymep.com**

Note: When obtaining service always have the following:

1. Model number of the product
2. Date of manufacture
3. Part number or description

