

SAFAVIEH LIGHTING

Assembly Instruction

CAUTION: Read instruction carefully and turn electricity off at main circuit breaker panel before beginning installation.

ITEM#: PND4006A

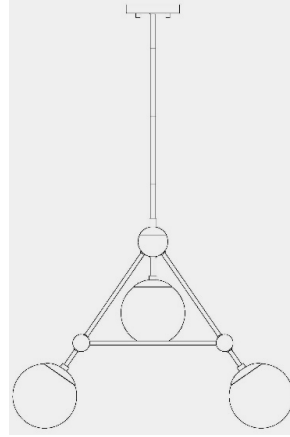

Care and Cleaning













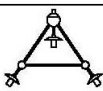

To clean the outside of the fixture, use a dry or slightly dampened clean cloth (use clean water, never a solvent) to wipe the surface of the fixture.

To clear the inside of the fixture, first disconnect power to the fixture by turning off the circuit breaker or by removing the fuse at the fuse box. Next, use a dry or slightly dampened clean cloth (use clean water, never a solvent) to wipe the interior surface of the fixture.

Do not use any cleaners with chemical, solvents or harsh abrasives. Use Only a dry soft cloth to dust or wipe carefully.

Estimated Assembly Time: 30 minutes

Part List and Hardware List

A	Wire Nut	X3		I	Tube 6"	X2	
B	Mounting Plate	X1		J	Tube 12"	X2	
C	Mounting Screw	X2		K	Fixture Body	X1	
D	Outlet Box Screw	X2		L	Metal Ring	X4	
E	Green Ground Screw	X1		N	Cap	X4	
F	Hex Nut	X2		M	Bulb	X4	
G	Canopy	X1		O	Glass Shade	X4	
H	Finial	X2					

Installation

Step 1

Attach the Mounting Plate (B) to the junction box using the Outlet Box Screw (D) on the ceiling wall.

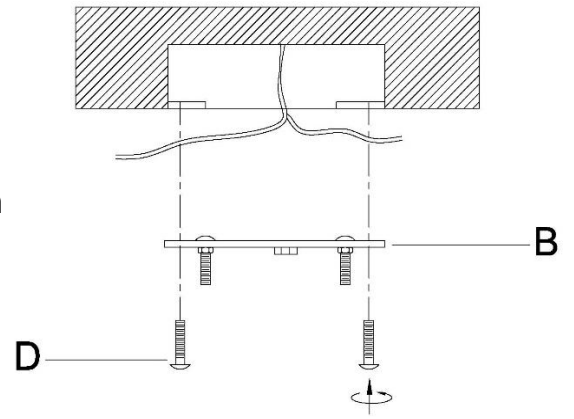

Step 2

Thread Tube (I, J) to the Fixture Body (K), then thread the Tube (I) to bottom of the Canopy (G).

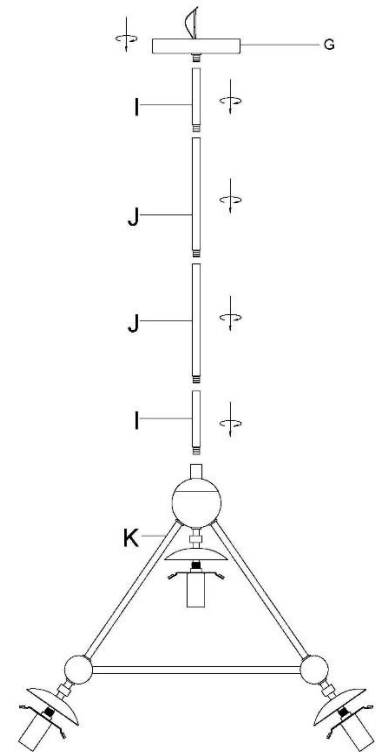

Step 3

Using the Wire Nut (A) connected the positive electrode and the negative pole of the fixture body carefully into the positive electrode and the negative pole in junction box.

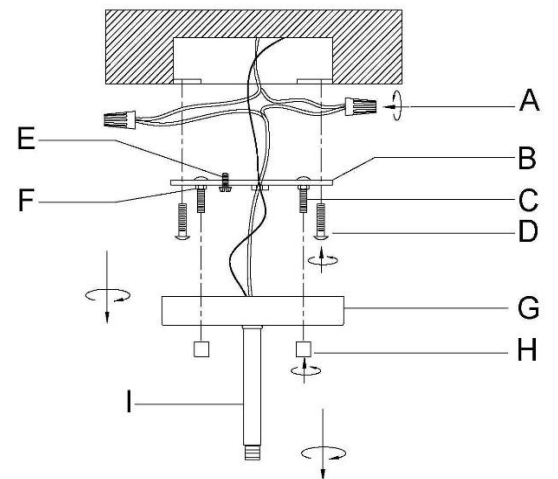

Step 4 Wire connection

Connect,Hot,Black or Red outlet Supply Wire to:	Connect,Neutral,White Outlet Supply Wire to:
Black	White
*Parallel Cord(round&smooth)	*Parallel Cord(square&ridged)
Clear,Brown,Gold or Black without Tracer(colored stripes)	Clear,Brwn,Gold or Black without Tracer(colored stripes)
Insulated Wire(not green)with copper metal conductor	Insulated Wire(not green)with Silver metal conductor

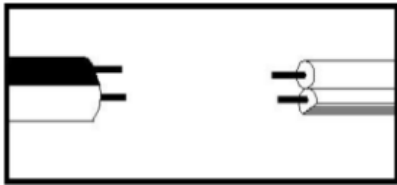

*Note: When parallel wire(SPTI&SPTII)is used. The neutral wire is square shaped and ridged and the hot wire will be round in shape and smooth.(See illustration on left)

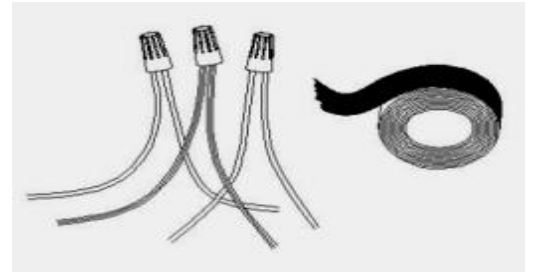

Grounding Instructions:

a) For installation in the United States: Wrap ground wire from outlet box around green ground screw on mounting bracket, no less than 2" from wire end. Tighten ground screw. If fixture is supplied with a ground wire, connect to outlet ground wire with a wire connector.

b) For installation in Canada: If fixture is supplied with ground wire, wrap ground wire around green grounding screw on mounting bracket. Tighten ground screw.

Step 5

Attach the Canopy (G) through Mounting Screw (C), secure Canopy (G) with Finial (H) to Mounting Screw (C).

Install (4) Bulbs (M) into the sockets, insert the clips into the Glass Shades (O), and then secure the Caps (N) to the Glass Shades (O) with the Metal Rings (L).

**PLEASE USE ON/OFF TYPE "B" BULB MAX 40-WATT OR CFL BULB MAX 13-WATT OR LED BULB MAX 9-WATT
THERE ARE 3PCS 25W TYPE "B" BULB IN THE BOX.**

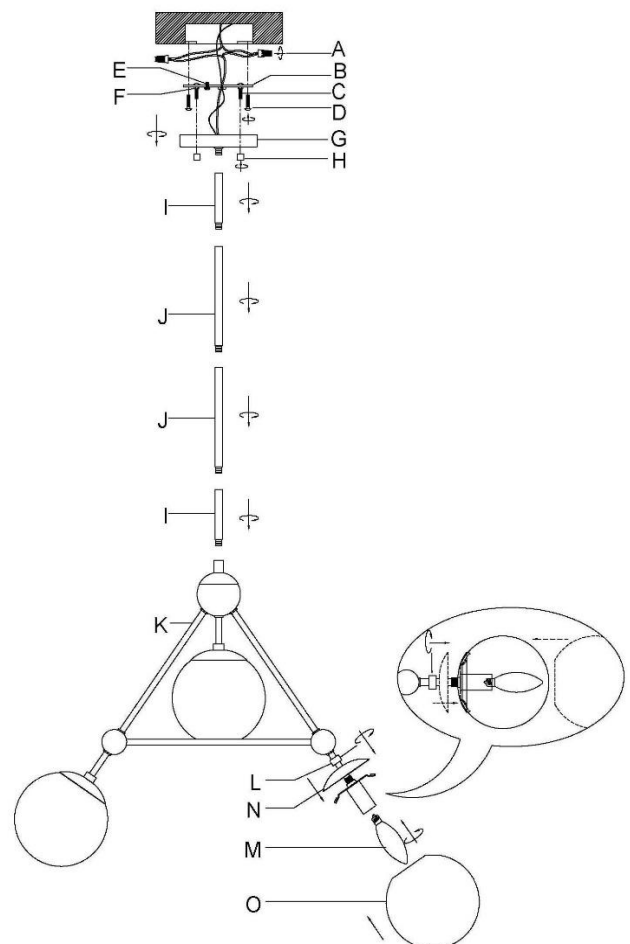

Step 6

Consult a qualified electrician to ensure correct branch circuit conductor.

ENJOY YOUR LAMP