

FOR MODELS

2646 3053****

2653 3054****

2739 3153****

2747 3060****

2753 3140****

2851 3238****

2853 3260****

2952 3660****

2953**

**MANUAL IS FOR MULTIPLE
WALK-IN TUB MODELS.
IMAGE MAY VARY FROM
ACTUAL PRODUCT.

DON'T WAIT! REGISTER NOW!

Register your product within 90 days to ensure your bathtub is recognized as an official purchase and is eligible for warranty coverage.

Mail in the completed registry card (Pg. 2) or register online at www.SWCORP.com/register.

PRODUCT REGISTRATION*

IMPORTANT: YOUR WARRANTY WILL NOT BE RECOGNIZED UNLESS THIS CARD IS FULLY COMPLETED AND RETURNED OR ONLINE REGISTRATION IS COMPLETED.

To ensure that your warranty is registered and confirmed please do one of the following:

- 1. Register online at www.SWCORP.com/register.** You will be asked to fill out the same information you would in the registration card. Registering online is fast, secure and ensures we receive your information.
- 2. Complete, cut-out and mail the registration card below.** By returning this registration card we confirm the date of purchase for your new product. This confirmation will allow us to process any warranty claims.

Mail the card to: 5701 NW 35 Avenue, Miami, FL 33142



Product Registration Card

Name Address

City State Zip

Phone Email.....

Date of Purchase..... **Order or Purchase #**..... **SKU or Model #**.....

Installer's Name Phone

I have read the Owner's Guide carefully and understand and agree that any installation, operation or maintenance of the bathtub must be done strictly in accordance with instructions and guidelines contained in the owner's manual and installation guide.

Signature..... **Date**.....

TABLE OF CONTENTS

PRODUCT REGISTRATION 2

THANK YOU FOR YOUR PURCHASE 4

SAVE THIS MANUAL! 5

UNPACKING THE UNIT 6

PRE-INSTALLATION 7

INSTALLATION PREPARATION 8

ELECTRICAL PREPARATION 9

INSTALLATION PROCEDURES 10

DRAIN CONNECTION 11

CONNECTING THE AUTO DRAIN 12

CONNECTING DOOR DRAIN 14

INSTALLATION AND EXTENSION PANELS 15

FAUCET INSTALLATION 16

OPERATING SAFETY INSTRUCTIONS 17

OPERATING INSTRUCTIONS 19

TUB CONTROLS 20

CLEANING AND MAINTENANCE 21

WARRANTY 22

RETURN POLICY 23

THANK YOU FOR YOUR PURCHASE!

The purchase of a walk-in bathtub is made out of a necessity for safety, comfort and quality of life. It is not a small investment but it pays for itself by recapturing the peace of mind and freedom you once had.

Our mission is to provide anyone with limited mobility the tools they need to once again enjoy the complete bathing experience.

To help ensure you get the most out of your investment below is list of ESSENTIAL DO's and DON'Ts that must be kept in mind during and after your bathtub's installation.

ESSENTIAL DO'S & DON'TS

DO REGISTER YOUR PRODUCT!

Register your product within 90 days to ensure your bathtub is recognized as an official purchase and is eligible for warranty coverage. *Mail the completed registry card (Pg. 2) or register online at www.SWCORP.com/register.*

DO LEVEL THE TUB USING THE BUILT-IN LEVELING FEET TO PREVENT DOOR LEAKAGE!

Every walk-in bathtub comes equipped with adjustable leveling feet. *THE LEVELING FEET MUST BE ADJUSTED TO ENSURE THE TUB IS LEVEL AGAINST THE ONSITE FLOOR/SURFACE. FAILURE TO DO SO MAY RESULT IN LEAKAGE!*

DO REPORT ANY DEFECTS, DAMAGES OR MISSING ITEMS RIGHT AWAY!

Thoroughly review the bathtub and contents of the package. Any defects or damages must be reported within 5 business days of receiving the product.

DON'T LIFT OR PULL THE BATHTUB BY THE PLUMBING!

Every walk-in bathtub is built with a steel support frame. This support frame features a set of handles which should be used to lift, push and pull the bathtub to ensure no damage is done to the tub body, components or plumbing.

DON'T LEAN OR SUPPORT YOURSELF ON THE BATHTUB DOOR!

The bathtub door's alignment is key to providing a watertight seal. Using the door to support your weight or leaving the door open for extended periods of time will compromise this alignment and possibly lead to leakage.

SAVE THIS MANUAL!

READ THESE INSTRUCTIONS COMPLETELY BEFORE INSTALLING THE PRODUCTS. FAILURE TO DO SO COULD RESULT IN AN IMPROPER INSTALLATION AND COULD VOID THE WARRANTY.

RESPONSIBILITY OF THE INSTALLER

THE INSTALLER MUST INSPECT AND WATER TEST THE PRODUCT PRIOR TO INSTALLATION TO ENSURE THE UNIT IS FREE OF DEFECT OR DAMAGE. IN THE EVENT OF A PROBLEM, THE UNIT MUST NOT BE INSTALLED. IF THE CRATE OR THE PRODUCT HAS BEEN DAMAGED DURING SHIPPING, PLEASE CALL US IMMEDIATELY.

THIS PRODUCT MUST BE INSTALLED BY A LICENSED/CERTIFIED CONTRACTOR

LICENSED PLUMBERS AND ELECTRICIANS SHOULD BE EMPLOYED TO INSURE PROPER INSTALLATION. INSTALLERS ASSUME ALL LIABILITY FOR THE CORRECT INSTALLATION PROCEDURES. ONLY ACCESSORIES AUTHORIZED BY THE MANUFACTURER SHOULD BE USED WITH THIS PRODUCT.

WARNING! WHEN USING THIS PRODUCT, BASIC PRECAUTIONS SHOULD ALWAYS BE FOLLOWED. READ AND FOLLOW ALL INSTRUCTIONS PERTAINING TO RISK OF FIRE, ELECTRICAL SHOCK, AND/OR OTHER INJURIES.

IMPORTANT SAFETY INSTRUCTIONS. INSTRUCTIONS IMPORTANTES RELATIVES A LA SECURITE.

READ AND FOLLOW ALL INSTRUCTIONS. LIRE ET SUIVRE TOUTES LES INSTRUCTIONS.

SAVE THESE INSTRUCTIONS. CONSERVER CES INSTRUCTIONS.

WARNING: RISK OF ACCIDENTAL INJURY OR DROWNING; CHILDREN SHOULD NOT USE HYDROMASSAGE BATHTUB WITHOUT ADULT SUPERVISION. **AVERTISSEMENT.** RISQUE DE BLESSURE ET DE NOYADE. NE PAS LAISSER UN ENFANT UTILISER LA CUVE A REMOUS EN L'ABSENCE D'UN ADULTE

WARNING: TO AVOID INJURY, EXERCISE CARE WHEN ENTERING OR EXITING THE HYDROMASSAGE BATHTUB. **AVERTISSEMENT.** POUR EVITER LES BLESSURES, USER DE PRUDENCE EN ENTRANT DANS LA CUVE A REMOUS ET EN LA QUITTANT.

WARNING: RISK OF ELECTRIC SHOCK; DO NOT PERMIT ELECTRIC APPLIANCES (SUCH AS A HAIR DRYER, LAMP, TELEPHONE, RADIO, OR TELEVISION) WITHIN 1.5 M OF THIS HYDROMASSAGE BATHTUB. **AVERTISSEMENT.** RISQUE DE CHOC ELECTRIQUE. NE PAS PLACER D'APPAREILS ELECTRIQUES (LUMINAIRE, TÉLÉPHONE, RADIO, TELEVISEUR, ETC.) A MOINS DE 1.5 M DE CETTE CUVE A REMOUS.

CAUTION: TEST THE GROUND FAULT CIRCUIT INTERRUPTER PROTECTING THIS APPLIANCE PERIODICALLY IN ACCORDANCE WITH THE MANUFACTURER'S INSTRUCTIONS. **ATTENTION.** VERIFIER REGULIEREMENT LE FONCTIONNEMENT DU DISJONCTEUR DE FUITE A LA TERRE CONFORMEMENT AUX INSTRUCTIONS DU FABRICANT.

UNPACKING THE UNIT

USE FRAME HANDLES TO LIFT/MOVE TUB. NEVER BY THE PLUMBING!

Never lift the walk-in bathtub by the plumbing. Doing so may result in damaging the plumbing and causing a leak.

INSPECTING THE UNIT

Immediately inspect the unit for damage even if there is no carton damage. If any damages are noted, photograph the damaged area(s) and notify us immediately. Damages must be reported within 5 business days. Once the unit is installed surface damages will be assumed to be installation related if not reported at this point.



PLACING THE UNIT

Please note that an installer(s) assumes full liability for damages to the walk-in bathtub after the unit is installed in the “cradle”/niche.

WHAT’S INSIDE

Inside you’ll should find the following:

- Walk-In Bathtub Unit
- Walk-In Bathtub Extension Kit (if applicable)
- Waste & Overflow Kit
- Sanitary Tee
- Door Drain Adaptor with 3/8” Barb
- Faucet Set (if applicable for model)
- Suction Cup Handle
- Owner’s Manual (with Registration Card)

PRE-INSTALLATION*

** All walk-in bathtubs are 100% water tested at the factory certified to be free of leaks. Transportation and mishandling may cause leaks. It is necessary to test the bathtub while there is access to all sides of the bathtub.*

TEST THE BATHTUB WHILE YOU HAVE ACCESS TO ALL SIDES AND BEFORE PERMANENTLY INSTALLED.

READ AND FOLLOW ALL INSTRUCTIONS

- Place the tub on a completely flat surface in an area where it may be drained after testing.
- Close the drain and fill the tub until it is above the highest jet. If it's a soaker fill up to normal water height level.
- Allow the water to stand in tub for 30 minutes and then inspect all plumbing and seals for leaks.
- If tub is jetted, supply electric to unit and run for 10 minutes and inspect for leaks. Inspect the unions around the pump; if leaks persist from the unions after tightening; loosen the unions and insure the O-ring is seated properly.

NOTE: IF THE PUMPS DO NOT OPERATE, CHECK THE BREAKER TO ENSURE POWER IS ON AND THE CABLE CONNECTING THE CONTROLS TO THE PUMP IS ATTACHED.

WARNING! DO NOT RUN ANY PUMPS UNLESS THE TUB IS FILLED WITH WATER TO PROPER LEVEL. DAMAGE DUE TO DRY RUNNING PUMPS IS NOT COVERED UNDER WARRANTY. FAILURE TO PERFORM THESE TESTS BEFORE INSTALLATION WILL MAKE THE INSTALLER LIABLE FOR FUTURE REPAIR COSTS.

A BAD LEVEL WILL MAKE YOUR TUB LEAK!

1. CHECK FLOOR LEVEL

2. ADJUST LEVELING FEET AS NEEDED

Clear the floor of any debris or trash and use a 5-6 foot level to determine if the floor is level. If the floor is not level, it is imperative that the bathtub's leveling feet are used to ensure the tub itself is perfectly level.

Note: it is important that all leveling feet are completely touching the floor and level for the door system to work properly.

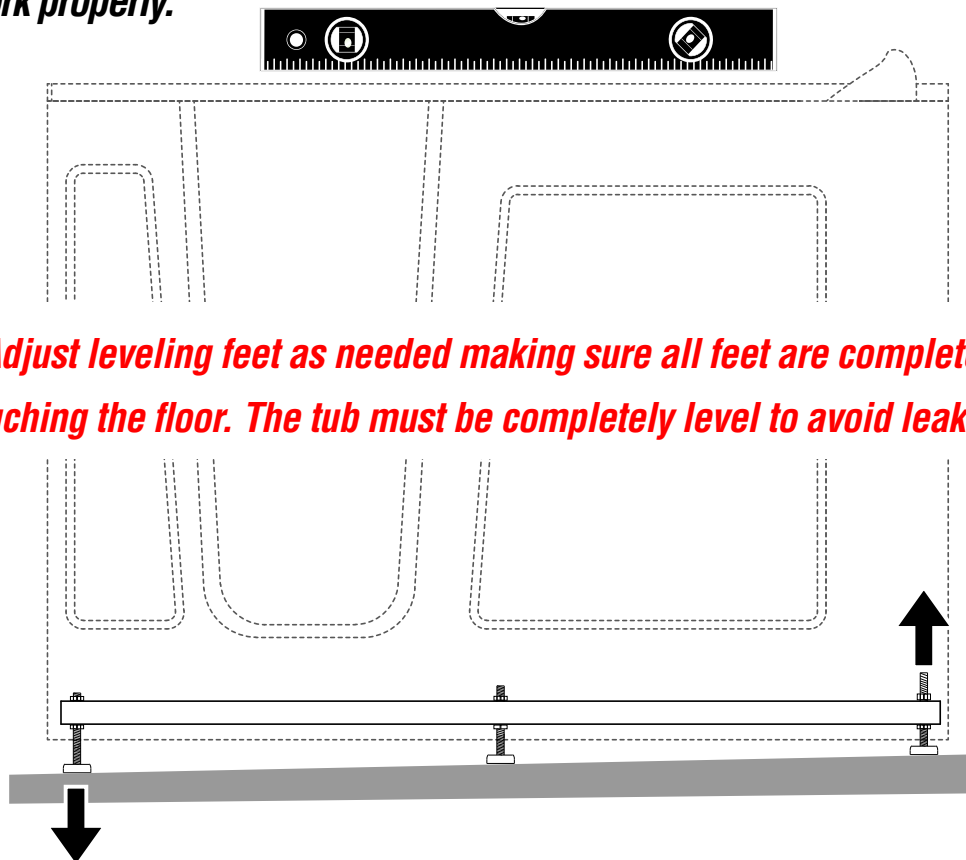

Adjust leveling feet as needed making sure all feet are completely touching the floor. The tub must be completely level to avoid leakage.

1. Check to ensure that the drain piping has been “roughed-in” at the proper location.
2. Ensure that the proper electrical service has been installed at the pump location. See electrical requirements in the manual (on following page).

ELECTRICAL PREPARATION

All electrical wiring must be installed in accordance with the National Electrical Code and with all local codes. All wiring shall be done by a qualified electrician. Run one, two or three branch circuits (as required) from the main electrical service panel to the pump area of the framing structure to provide power to the unit.

Electrical components have specific wiring requirements. Refer to the matrix below for the electrical supply requirements for the jet massage bathtub and factory installed components.

Branch circuits must be rated for 110 – 120 volts. Use 12 Gauge, 3 conductor cable for the circuits. If the length run exceeds 100 feet check with local codes for requirements. Install moisture proof junction box(s) 6” above the floor at the pump end of the framing for each circuit.

NOTE: DO NOT INSTALL THE JUNCTION BOX(S) WHERE IT CAN BE REACHED WHILE SITTING OR STANDING IN THE TUB OR TOUCHING THE FAUCETS.

AUTO DRAIN™, LIGHTS, WHIRLPOOL, AIR SPA, COMBO & HEATER ELECTRICAL REQUIREMENTS

This section lists the factory installed components of the Jet Massage and/or Air Massage Systems.

Systems	Electrical Rating Circuit 1	Dedicated Circuit
Soaker w / Auto Drain™	15 Amp GFCI	
Soaker w / Light	15 Amp GFCI	
Soaker w / Auto Drain™ w / Light	15 Amp GFCI	
Jet Massage Or Air Massage	15 Amp GFCI	
Jet Massage Or Air Massage w / Light	15 Amp GFCI	
Jet Massage Or Air Massage w/ Auto Drain™	15 Amp GFCI	
Jet Massage Or Air Massage w/ Light & Auto Drain™	15 Amp GFCI	
Jet Massage & Air Massage (Dual)	20 Amp GFCI	
Jet Massage & Air Massage (Dual) w/ Light	20 Amp GFCI	
Jet Massage & Air Massage (Dual) w/ Auto Drain™	20 Amp GFCI	
Jet Massage & Air Massage (Dual) w/ Light & Auto Drain™	20 Amp GFCI	
Whirlpool Inline Heater - Dedicated 15 Amp Circuit		15 Amp GFCI

All electrical connections must be carried out by a certified electrician in accordance with local electrical requirements and codes.

INSTALLATION PROCEDURES

WARNING! WHEN INSTALLING A JETTED WALK-IN BATHTUB, THE FOLLOWING BASIC PRECAUTIONS SHOULD BE FOLLOWED.

DANGER! RISK OF ELECTRIC SHOCK. CONNECT ONLY TO SEPARATE CIRCUIT PROTECTED BY A GROUND FAULT CIRCUIT INTERRUPTER (GFCI) ON PLUG IN UNITS.

NOTE: INSTALLATION MUST PROVIDE ACCESS FOR SERVICING PUMP/MOTOR (ALL TUBS COME WITH AN ACCESS PANEL FOR THE PUMP/MOTOR).

GENERAL GUIDE-THROUGH

- Install tub waste/overflow according to instructions (see page 11).
- After framing is a complete (see attached diagrams), set product in place to make certain the tub can be properly leveled. (Caution: If a walk-in bathtub is not resting on all leveling feet, water will not drain properly and may cause the door to leak) (see page 8).
- ***Verify the product's level by checking tub's deck surface and ensure all leveling feet are touching the ground (see page 8).***
- Electrical connection is made pre-instruction on specified models.
- After plumbing and electrical connections have been made, the tub should be cleaned of dirt and debris.
- Installation is not complete until the tub has been tested in place.

DRAIN CONNECTION

To ensure safe transit for your walk-in tub, the overflow drain components are not connected to the unit during the process of production. The following instructions are provided for installation purposes:

Your walk-in tub is supplied with a 1 1/2" drain pipe overflow.

1. The open and close valve with the turn knob should be attached to the unit at the 1 1/2" pre-drilled opening in the wall of the unit from the outside.
2. The opposite end of the overflow should be attached to the 1 1/2" pre-drilled opening in the foot well of the unit from the underside.
3. The chrome turn knob and the drain cover should be attached to the appropriate ends of the overflow drain from the inside of the unit.
4. Place the chrome cap with stem into the floor drain to close off the opening.
5. The cable attached to the turn knob of the overflow is also connected to a lever inside the floor drain which allows the drain to be opened or closed.
6. Once the components of the overflow are secured into place, turn the overflow knob to the open and closed position to ensure proper function. The cap and stem will move up and down, opening and closing the drain (Figure 1).

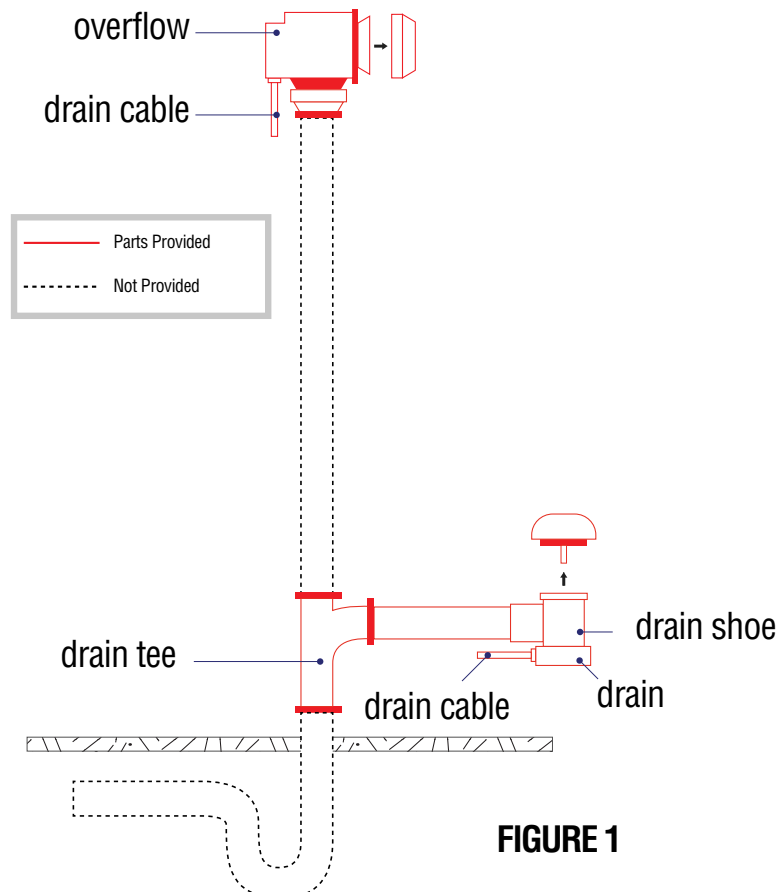

FIGURE 1

CONNECTING THE AUTO DRAIN

1. Drain System requires the connection to a minimum 1 ½ sanitary drain line.
2. Use UPC Approved PVC Glue, primer, and Schedule 40 1 ½ ' pipe.
3. Do not change or modify the location and or piping of the Back Flow Preventer.
4. The sanitary tee is installed directly above the drain tee with clearance not greater than 1”.
5. Dry fit the drain overflow assembly to the sanitary drainage pipe and check for proper fit.
6. Glue the High-Speed Auto drain Fittings, pipe and drain overflow assembly to the sanitary drainage pipe.
7. Reference figure 2 for connecting auto drain in a soaker or air jetted tub. (page 13)
8. Reference figure 3 for connecting auto drain in a hydro or dual jetted tub. (page 13)

• NOTE: WATER TIGHT INSTALLATION OF THE WASTE/ OVERFLOW IS THE INSTALLER’S RESPONSIBILITY. DRAIN LEAKAGE IS EXCLUDED FROM MEDITUB WARRANTY OF THIS PRODUCT.

WARNING: WE HAVE TAKEN RESPONSIBLE PRECAUTIONS TO ENSURE THE HIGH-SPEED AUTO DRAIN IS SUITABLE FOR RESIDENTIAL PLUMBING. IT IS THE RESPONSIBILITY OF THE INSTALLER TO INSURE THE SANITARY SYSTEM IS ACCEPTABLE FOR THE USE OF THE HIGH-SPEED AUTO DRAIN. WE DO NOT ACCEPT RESPONSIBILITY FOR DAMAGE ARISING FROM THE USE OF THE HIGH- SPEED AUTO DRAIN. *

**-Ensure compliance with local plumbing codes.*

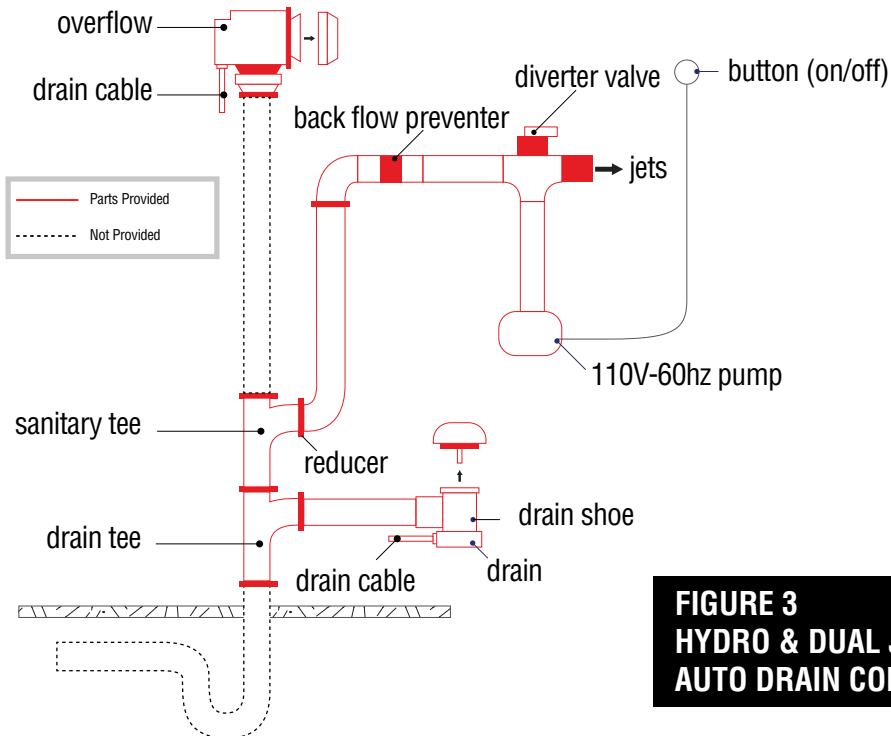
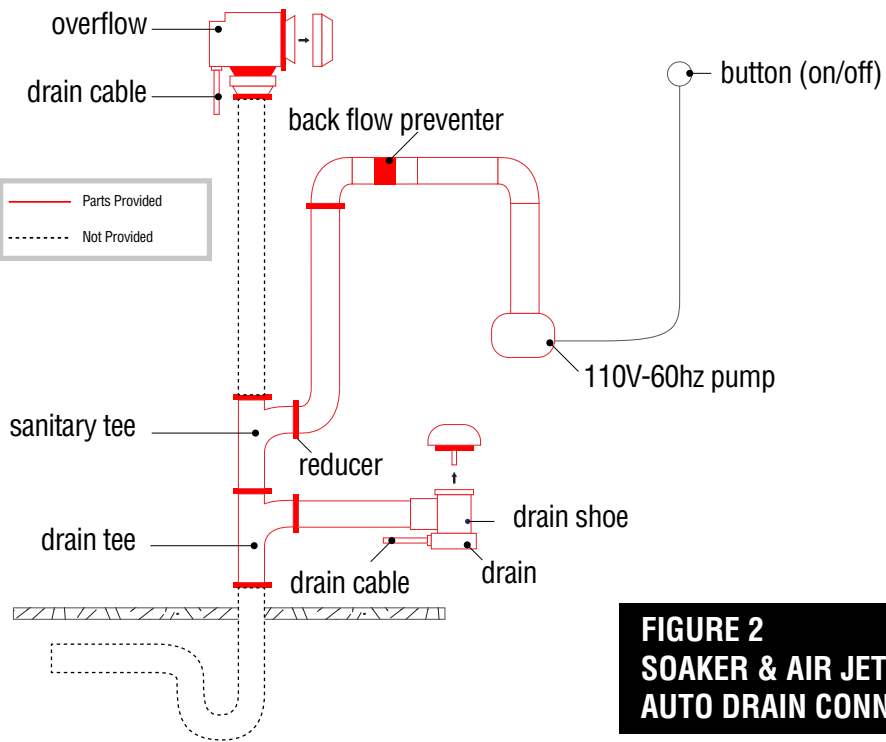

DOOR DRAIN CONNECTION

Your walk-in tub also has a door drain to remove excess water from the door after each use.

1. From the underside of the unit, a hose is connected to the door drain with a check valve. This hose and valve is to provide a one-way flow from the door drain to the main drain pipe. The check valve will constrict the water flow away from the door.
2. Insert the opposite end of the hose into the port on the main drain. Be sure the port is open before attaching the hose. Secure the hose with clamps or ties.
3. Once the hose is in place, close the door on the unit, place the handle in the locked position, and fill tub with at least 12" of water to test the connection.
4. Once the completion of the drain components are installed and have been tested for proper function, the unit can be leveled and give a final water test before installation of unit (Figure 4).

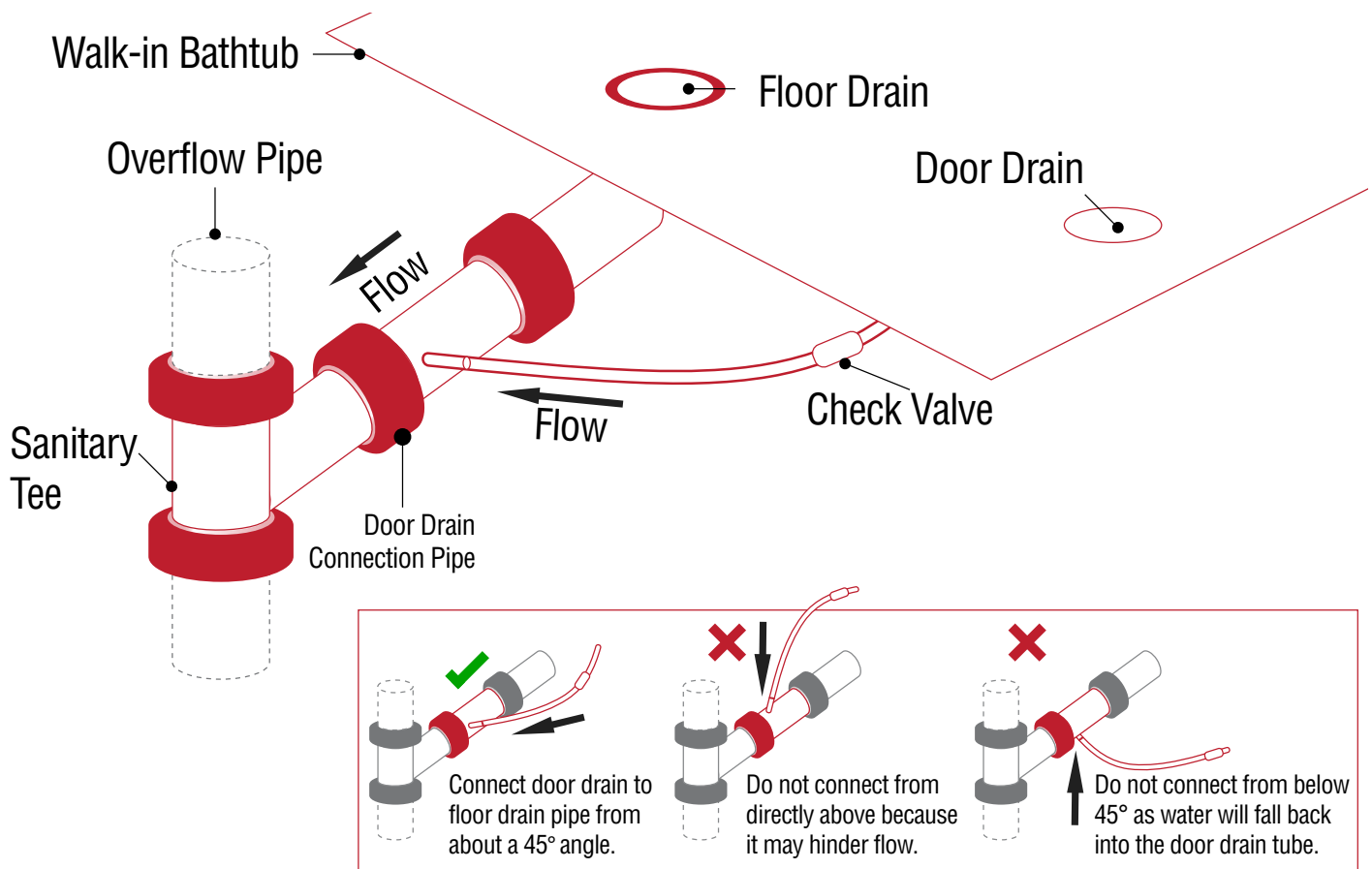
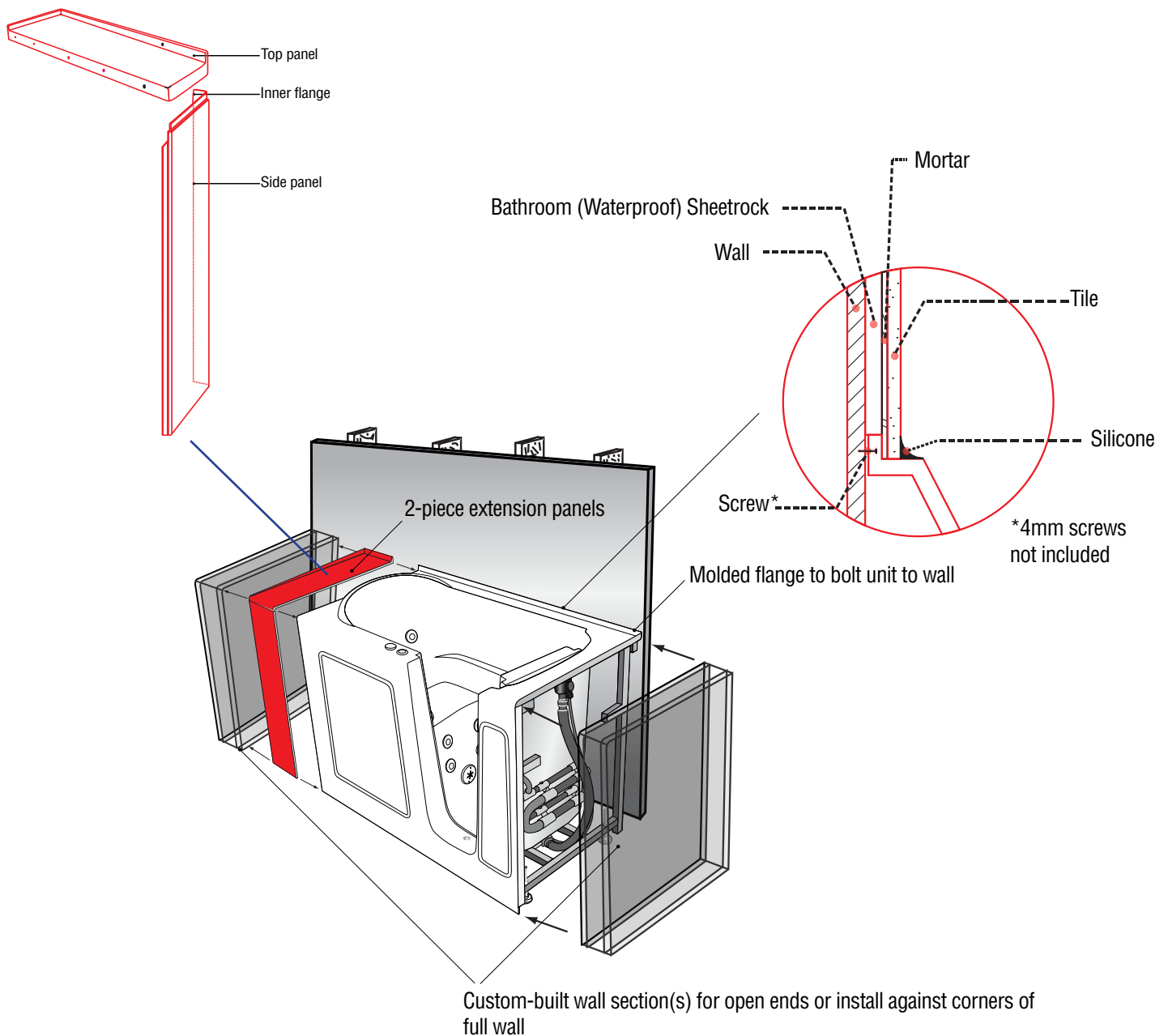

FIGURE 4

INSTALLATION AND EXTENSION PANELS

ASSEMBLY & PLACEMENT

Connect the two panels using pre-drilled holes:



INSTALLATION INSTRUCTIONS

FAUCET INSTALLATION

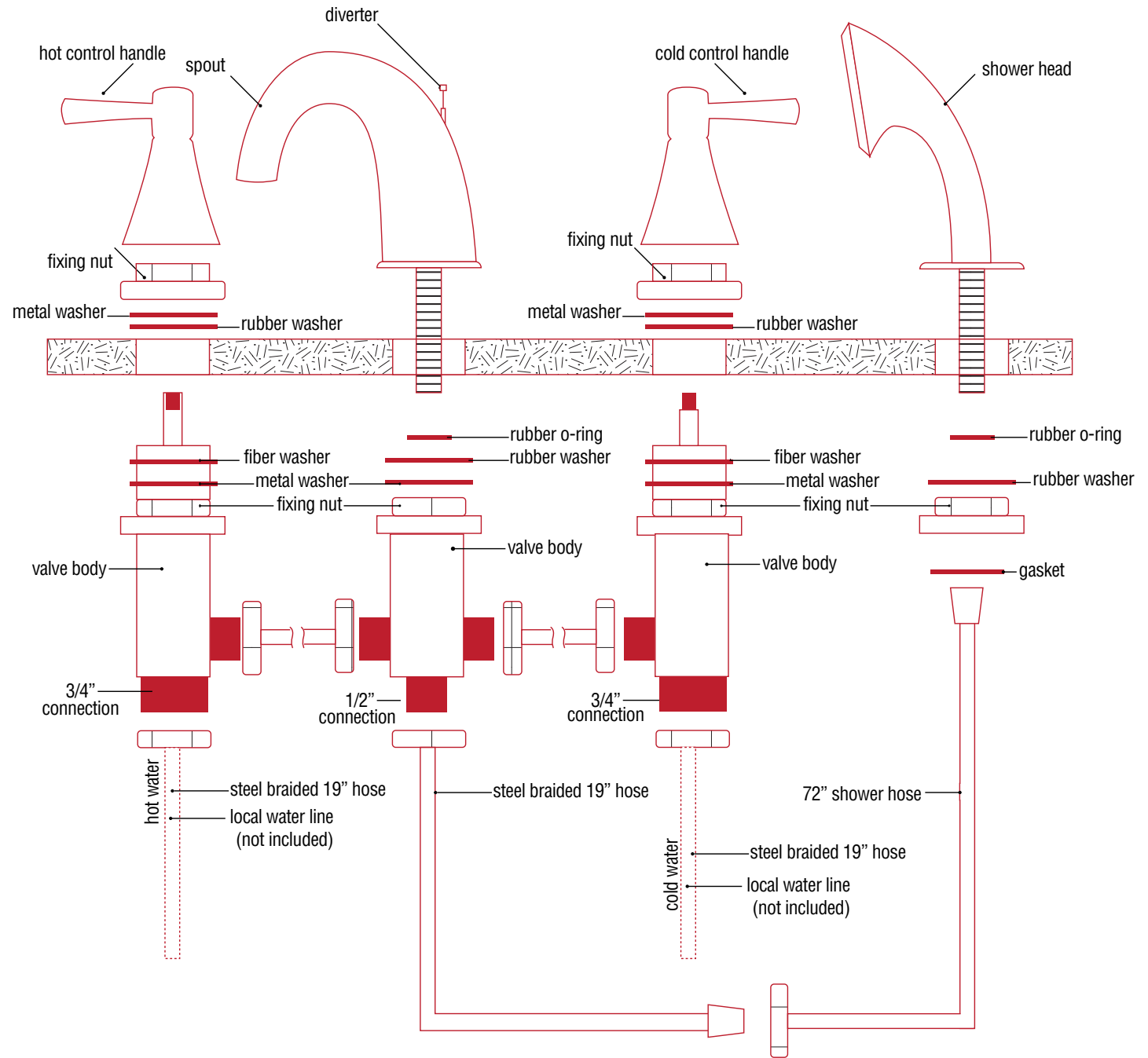

INSTALLATION INSTRUCTIONS

OPERATING SAFETY INSTRUCTIONS

INSTRUCTIONS PERTAINING TO RISK OF FIRE, ELECTRICAL SHOCK OR INJURY TO PERSONS

WARNING! RISK OF PERSONAL INJURY:

- Use this unit for its intended use as described in this manual. DO NOT use attachments not recommended by the manufacturer.
- To avoid injury, exercise caution when entering or exiting your walk-in tub.
- To reduce the risk of injury, do not permit children or persons with infirmities to use this product unless they are closely supervised at all times.
- The maximum recommended temperature is 102 F° (38.8 C °). Fifteen minutes per soak is the recommended maximum time at 102 F°, which may induce Hyperthermia which is an increase in body temperature. This can be a serious medical condition and all bath users are cautioned against lengthy immersion at high water temperatures. Should you become light-headed, dizzy, or nauseous, immediately get out of the bath and cool off.
- Risk of electric shock; do not permit electric appliances (such as a hair dryer, lamp, telephone, radio or television) within four feet of this bathtub.
- Never drop or insert any objects into any openings.
- Do not operate this unit without the guard over the suction fittings.

WARNING! RISK OF HYPERTHERMIA AND POSSIBLE DROWNING. People using medications, herbal remedies, sleep aids, and /or having adverse medical history should consult a physician before using this product.

WARNING! NO FOOD OR ALCOHOLIC BEVERAGES. Use of your bathtub immediately after meals is not recommended. Avoid alcohol consumption before or during the bathing. Alcoholic beverages can cause drowsiness or hyperthermia resulting in loss of consciousness or even drowning.

OPERATING SAFETY INSTRUCTIONS CONTINUED

The unit must be connected only to a supply circuit that is protected by a ground-fault circuit-interrupter (GFCI). Such a GFCI should be provided by the installer and should be tested on a routine basis. To test the GFCI, push the test button. The GFCI should interrupt power. Push the reset button. Power should be restored. If the GFCI fails to operate in this manner, there may be a ground current flowing, indicating the possibility of an electric shock. Do not use this massage bathtub. Disconnect the jet massage bathtub and have the problem corrected by a qualified service representative before using.

To reduce the risk of electrical shock, the dedicated electrical supply circuit(s) must be grounded. To do this, connect the third leg of the 3-conductor wiring cable to the grounding terminal of the electrical service panel and run continuously to the green grounding screw on the GFCI or electrical receptacle in the wiring compartment.

IN-LINE HEATERS

If your bathtub is equipped with an in-line heater, it will operate only when the pump is on.

NOTE: THE IN-LINE HEATER IS DESIGNED TO KEEP YOUR WATER WARMER LONGER, BUT IS NOT DESIGNED TO INCREASE THE WATER TEMPERATURE. HEAT SETTINGS ARE NOT ADJUSTABLE.

OPERATING INSTRUCTIONS

When entering the walk-in tub, be sure to close the door, placing the **handle** in the **down position**. Before activating any of the jetting controls, you must first fill the bath to a water level at least 2 inches above the highest jet placement. Do not put weight on the door when entering and exiting the tub. It is recommended to leave the door in the open position when the tub is not in use.

The pump is operated by the **hydro control button**, which starts the water flow. The blower is operated by the **air control button** which starts the air flow (see page 20).

Adjust the direction and rate of flow of the jets by moving the nozzle for direction. Turn either the outside ring or the nozzle clockwise or counterclockwise for flow (some jets adjust the flow with the outside ring and some with the nozzle). Adjust the air pressure flow of all water jets by using the **hydro jet flow control** (see page 20), which controls air-water mixture.

Our walk-in tubs equipped with the chromotherapy lights (**ordered separately**), feature a dedicated on/off switch. Pressing the switch off and back on will change the color of light (see page 20).

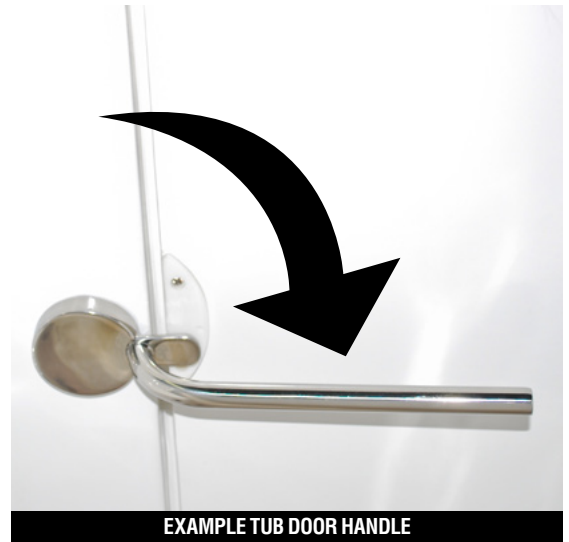

EXAMPLE TUB DOOR HANDLE

TUB CONTROLS

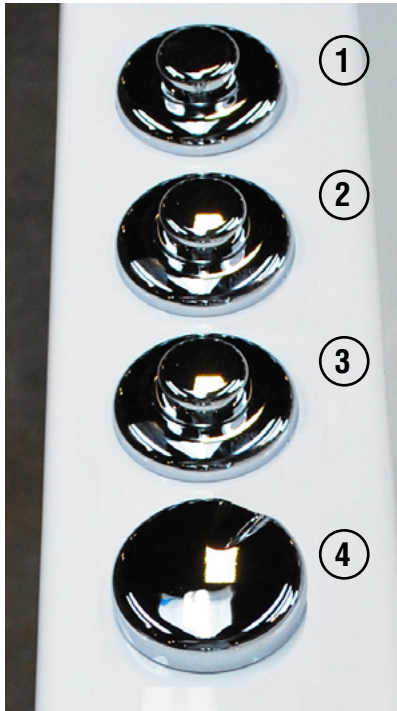

FOR TUBS WITH WATER JET OPTION.
1 HYDRO CONTROL (PUMP)

Used to turn the water jets **ON** and **OFF**.

FOR TUBS WITH AIR JET OPTION.
2 AIR CONTROL (BLOWER)

Used to turn the air jets **ON** and **OFF**.

FOR TUBS WITH CHROMATHERAPY LIGHT OPTION.
3 CHROMATHERAPY LIGHT

PRESS ONCE (when light is OFF) - Turns light ON in Auto-Cycle Mode which will slowly transition from color to color.

PRESS TWICE (when light is ON)- Turns on static, non-changing color mode. Continue to press twice to move on to the next color until you find your desired choice.

PRESS ONCE (when light is ON) - Turns off light. Resets cycle after 2 second pause.

FOR TUBS WITH WATER JET OPTION.
4 HYDRO JET FLOW CONTROL

Used to increase or decrease air pressure flowing through the water jets.

OPERATING INSTRUCTIONS



FOR TUBS WITH AUTO DRAIN OPTION.
AUTO DRAIN DIVERTER

While the HDYRO PUMP is running, use this diverter to channel the pumped water through the HYDRO JETS or down the drain.



FOR TUBS WITH AROMATHERAPY OPTION.
AROMATHERAPY CAP

Unscrew cap and insert your favorite fragrance beads to bathe in a soothing aroma scent.



FOR TUBS WITH HEATED BACKREST OPTION.
HEATED BACKREST

Used to turn heated pads **ON** and **OFF**. Will turn off after 20 minutes. **Note:** Light may blink for 2 seconds and turn off. This just indicates system is initiating. Simply press the button again to activate heating pads.

CLEANING AND MAINTENANCE

Pump and pipe circulation systems should be flushed before first use and on a monthly basis when product is under normal use.

Below are the recommended procedures for cleaning:

- Do not run whirlpool dry. Fill the tub with hot water 2-3 inches above the jets and add 2-3 teaspoons of low foaming detergent such as dishwashing machine detergent
- Turn on whirlpool system and run for 10 minutes
- Drain tub completely
- Fill tub with cold water above jets
- Turn on whirlpool system and run for 15 minutes
- Drain tub completely
- Cleaning the suction cover: Clean and remove any hair or lint from the suction cover (see image below). On a monthly basis, unscrew the suction cover and clean away any hair, lint or debris from the cover and housing, then remount the cover in place. Some suction covers are not designed to be removed; only suction covers that have screws on the cover, visible from the inside of the tub, can be removed.

WARNING! NEVER OPERATE THE UNIT WITH THE SAFETY SUCTION COVER OFF.



SUCTION COVER

WARRANTY

DON'T FORGET TO REGISTER! PRODUCT MUST BE REGISTERED WITHIN 90 DAYS OF DELIVERY DATE TO ACTIVATE WARRANTY. REGISTER AT WWW.SWCORP.COM/REGISTER OR FILL OUT AND MAIN IN THE REGISTRATION CARD ON PAGE 2 OF THIS MANUAL.

IMPORTANT! THOROUGHLY REVIEW THE BATHTUB AND CONTENTS OF THE PACKAGE. ANY DEFECTS OR DAMAGES MUST BE REPORTED WITHIN 5 BUSINESS DAYS OF RECEIVING THE PRODUCT.

This 10-year warranty is extended to the first user to be free from defects in workmanship and material under normal use and conditions for a period of **10 years** from the date of the original purchase. This warranty relates to the bathtub shell, frame and finish. The finish's warranty does not apply to fading, cracking, delaminating or blistering due to excessive wear, sun fading or scouring due to cleaning. Different warranty periods apply. The tub and all its components including motors, electronic controls, waste and overflow, fittings and all plated finishes are covered by a limited 1 year warranty, subject to verification of the defect or malfunction. All labor and repair-related services are covered within the first **90** days of purchase. This warranty is non-transferable and applies only to the original owner as stated on the original purchase order. Notification **must be** sent via certified mail to **5701 NW 35 Avenue. Miami, FL 33142**. The manufacturer will not be responsible for any water damage to any structures or any property for any reason (including but not limited to manufacturer defects or improper installation). Manufacturer will assume no responsibility for the loss of the system, inconvenience due to loss, damage to real or personal property or any other consequential damage. Manufacturer will not be liable for any incidental expenses or material charges in connection with removal or replacement of the purchased part or any part or parts of the system. Manufacturer is not responsible for failures or damage that could have been discovered, repaired, or avoided by proper inspection and testing prior to installation. This warranty shall not apply to any type of failure resulting from negligence, abuse, misuse, misapplication, improper installation, alteration or modification, chemical corrosion or improper maintenance. Scratches and surface damages must be reported within 5 days of delivery and prior to installation.

Scratches and other surface damages reported after installation will be assumed to be a result of installation and will not be covered. Every walk-in tub must be installed by a licensed plumber, electrician and/or contractor; failure to do so will hereby void the warranty. There will be a charge for replacement parts or the replacement of the entire electrical unit if the defective unit is returned for any of the reasons listed above.

NOTE: WITHIN THE LIMITED ONE YEAR WARRANTY, THERE WILL BE A PRORATED CHARGE FOR ANY ELECTRICAL AND PLATED REPLACEMENTS PARTS, INCLUDING SHIPPING AND HANDLING CHARGES.

Manufacturer reserves the sole authority to make any type of warranty changes at any time. The manufacturer will not be responsible for any warranty information that is being misrepresented by outside sources including dealers, retailers, distributors or contractors. Manufacturer does not warranty the installation, plumbing or electrical related connections, of any of our products including Walk-In Baths, shower pans or shower stalls. Improper or negligent installation of the product or other components, alteration made of, or alterations or medications to the system, may cause the product or the system to malfunction. Such problems are not covered by warranty. Manufacturer warranties the door seal for the life of the unit under normal use and conditions for the **original owner** of the tub. This warranty shall not apply to any failure resulting from negligence, abuse, misuse, misapplication, alternation, or medication or improper maintenance. Additionally, this warranty does not cover discontinued or display products. The replacement door seal will be issued to the end user however installation and repairs must be performed by a certified installer/plumber. Manufacturer will not be liable for any incidental expenses or material charges in connection with removal or replacement of the door seal.

NOTE: TO THE EXTEND PERMITTED BY LAW, ALL IMPLIED WARRANTIES INCLUDING THOSE OF MERCHANT ABILITY AND FITNESS FOR A PARTICULAR PURPOSE ARE HEREBY DISCLAIMED. THIS COMPANY AND SELLER HEREBY DISCLAIM ANY LIABILITY FOR SPECIAL, INCIDENTAL, OR CONSEQUENTIAL DAMAGES.

Some states/provinces do not allow limitations on how long an implied warranty lasts, or the exclusion or limitation special, incidental or consequential damages, so these limitations and exclusions may not apply to you. This warranty gives you specific legal rights. You may have other rights, which vary from state/province to state province. All lawsuits must be filed in Miami-Dade County, Florida. Tub units are for residential use only.

RETURN POLICY

We are committed to providing premium customer service. In the event that a product must be returned due to reasons other than defects, as mentioned in the warranty, the following procedures apply:

Requests for returns and/or exchanges must be made within **30 days** of receipt of product. The product must be in its original packaging and received at our facility in saleable condition. All returns will receive a **20% restocking fee** plus all **freight costs** of the original shipment and return shipment to us.

All requests for return must first be approved by us and have an assigned **Returned Merchandise Authorization number** (RMA#).