

IMPORTANT SAFETY RULES

Read, understand, and follow all instructions carefully before installing and using this product.

Round Metal Frame Pool

10' - 24' (305 cm - 732 cm) models



For illustrative purposes only. Accessories may not be provided with pool.

Don't forget to try these other fine Intex products: Pools, Pool Accessories, Inflatable Pools and In-Home Toys, Airbeds and Boats available at fine retailers or visit our website listed below.



IMPORTANT! DO NOT RETURN PRODUCT TO STORE

To purchase parts and accessories or to obtain non-technical assistance,
Visit www.intexcorp.com

For technical assistance and missing parts call us toll-free (for U.S. and Canadian Residents):

1-800-234-6839

Monday through Friday, 8:30am to 5:00pm Pacific Time

087-*PO-R1-1210

OWNER'S MANUAL

Warnings..... 3

Parts List & References..... 4-7

Setup Instructions..... 8-10

Pool Maintenance and Chemicals..... 11-12

Common Pool Problems..... 11

Pool Draining..... 12

Storage..... 12-13

General Aquatic Safety..... 14

Pool Safety Sign..... 15

Intex Service Center Locations..... 16

Special Introductory note:

Thanks for buying an Intex pool. Please read this manual before setting up your pool. This information will help extend the pool life and make the pool safer for your family's enjoyment. View the video included before installation. A team of 2-3 people is recommended for pool set up. Additional people will speed up the installation.

IMPORTANT SAFETY RULES

Read, Understand and Follow All Instructions Carefully Before Installing and Using this Product.

⚠ WARNING

- **Continuous and competent adult supervision of children and the disabled is required at all times.**
- Secure all doors, windows and safety barriers to prevent unauthorized, unintentional or unsupervised pool entry.
- Install a safety barrier that will eliminate access to the pool for young children and pets.
- Pool and pool accessories are to be assembled and disassembled by adults only.
- Never dive, jump or slide into an above-ground pool or any shallow body of water.
- Failure to set up pool on flat, level, compact ground or over filling could result in the pool's collapse and the possibility that a person lounging in the pool could be swept out/ejected.
- Do not lean, straddle, or exert pressure on the inflatable ring or top rim as injury or flooding could occur. Do not allow anyone to sit on, climb, or straddle the sides of the pool.
- Remove all toys and flotation devices from, in and around the pool when it is not in use. Objects in the pool attract young children.
- Keep toys, chairs, tables, or any objects that a child could climb on at least four feet (1.22 meters) away from the pool.
- Keep rescue equipment by the pool and clearly post emergency numbers at the phone closest to the pool. Examples of rescue equipment: coast guard approved ring buoy with attached rope, strong rigid pole not less than twelve feet (12') [3.66m] long.
- Never swim alone or allow others to swim alone.
- Keep your pool clean and clear. The pool floor must be visible at all times from the outside barrier of the pool.
- If swimming at night use properly installed artificial lighting to illuminate all safety signs, ladders, pool floor and walkways.
- Stay away from the pool when using alcohol or drugs/medication.
- Keep children away from pool covers to avoid entanglement, drowning, or other serious injury.
- Pool covers must be completely removed before pool use. Children and adults cannot be seen under a pool cover.
- Do not cover the pool while you or anyone else is in the pool.
- Keep the pool and pool area clean and clear to avoid slips and falls and objects that may cause injury.
- Protect all pool occupants from recreational water illnesses by keeping the pool water sanitized. Don't swallow the pool water. Practice good hygiene.
- All pools are subject to wear and deterioration. Certain types of excessive or accelerated deterioration can lead to an operation failure, and can ultimately cause the loss of large quantities of water from your pool. Therefore, it is very important that you properly maintain your pool on a regular basis.
- This pool is for outdoor use only.
- Empty and store the pool when not in use for a longer period. See storage instructions.
- All electrical components shall be installed in accordance with Article 680 of the National Electrical Code 1999 (NEC®) "Swimming Pools, Fountains and Similar Installations" or its latest approved edition.
- The installer of the vinyl liner shall affix on the original or replacement liner, or on the pool structure, all safety signs in accordance with the manufacturer's instructions. The safety signs shall be placed above the water line.

POOL BARRIERS AND COVERS ARE NOT SUBSTITUTES FOR CONTINUOUS AND COMPETENT ADULT SUPERVISION. POOL DOES NOT COME WITH A LIFEGUARD. ADULTS ARE THEREFORE REQUIRED TO ACT AS LIFEGUARDS OR WATER WATCHERS AND PROTECT THE LIVES OF ALL POOL USERS, ESPECIALLY CHILDREN, IN AND AROUND THE POOL.

FAILURE TO FOLLOW THESE WARNINGS MAY RESULT IN PROPERTY DAMAGE, SERIOUS INJURY OR DEATH.

Advisory:

Pool owners may need to comply with local or state laws relating to childproof fencing, safety barriers, lighting, and other safety requirements. Customers should contact their local building code enforcement office for further details.

SAFETY RULES

IMPORTANT SAFETY RULES

Read and follow all safety information and instructions.
Keep for future reference.
Failure to follow these warnings and instructions can result in serious injury or death to users, especially children.

⚠ WARNING

Prevent Drowning



- Children, especially children younger than five years, are at high risk of drowning.
- Drowning occurs silently and quickly and can occur in as little as 2 in. (5 cm) of water.
- Keep children in your direct sight, stay close, and actively supervise them when they are in or near this pool and when you are filling and emptying this pool.
- When searching for a missing child, check the pool first, even if child is thought to be in the house.
- Empty pool completely after each use and store the empty pool in such a way that it does not collect water from rain or any other source.

Drowning Risk:

- Keep unsupervised children from accessing the pool by installing fencing or other approved barrier around all sides of pools. State or local laws or codes may require fencing or other approved barriers. Check state or local laws and codes before setting up pool. Refer to the list of barrier recommendations and guidelines as described in CPSC Publication No. 362.
- Remove pool ladders before leaving the pool. Children as young as 2 years have climbed up ladders and into pools and drowned.
- Do not leave toys inside pool when finished using, since toys and similar items might attract a child to the pool.
- Position furniture (for example, tables, chairs) away from pool and so that children cannot climb on it to gain access to the pool.
- If a filter pump is included with the pool, locate pumps and filters in such a way that children cannot climb on them and gain access to the pool.

Diving Risk:

- Do not dive into this pool. Diving into shallow water can result in broken neck, paralysis, or death.

Electrocution Risk:

- Keep all electrical lines, radios, speakers and other electrical appliances away from the pool.
- Do not place pool near or under overhead electrical lines.

Suction Risk:

- If a drain or suction outlet cover is missing or broken, do not use the pool. Suction can cause body part entrapment, hair and jewelry entanglement, evisceration, or drowning. Repair or replace the drain or suction outlet cover before allowing the pool to be used.

First Aid:

- Keep a working phone and a list of emergency numbers near the pool.
- Become certified in cardiopulmonary resuscitation (CPR). In the event of an emergency, immediate use of CPR can make a life-saving difference.







Select an outdoor location for the pool with the following in mind:

1. The area where the pool is to be set up must be **absolutely flat and level**. Do not set up the pool on a slope or inclined surface.
2. The ground surface must be compacted and firm enough to withstand the pressure and weight of a fully set up pool. **Do Not** set up the pool on mud, sand, soft or loose soil condition, deck, platform, concrete, asphalt or any other hard surfaces.
3. The pool requires at least 4 feet of space all around pool from objects that a child could climb on to gain access to the pool.
4. Pool will kill the grass. Splash out could damage vegetation. Certain types of grass such as St. Augustine and Bermuda, may grow through the liner.
5. The area shall also facilitate drainage of the pool water after each use and/or for long term pool storage.

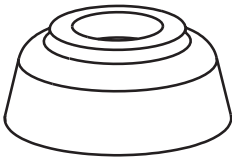
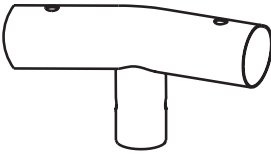
Barriers for Residential Swimming Pool Guidelines:

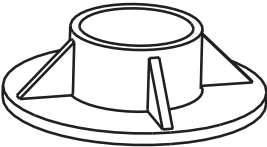
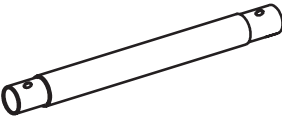
An outdoor swimming pool, including an inground, aboveground, or onground pool, hot tub, or spa, should be provided with a barrier which complies with the following:

1. The top of the barrier should be at least 48 inches above grade measured on the side of the barrier which faces away from the swimming pool. The maximum vertical clearance between grade and the bottom of the barrier should be 4 inches measured on the side of the barrier which faces away from the swimming pool. Where the top of the pool structure is above grade, such as an aboveground pool, the barrier may be at ground level, such as the pool structure, or mounted on top of the pool structure. Where the barrier is mounted on top of the pool structure, the maximum vertical clearance between the top of the pool structure and the bottom of the barrier should be 4 inches.
2. Openings in the barrier should not allow passage of a 4-inch diameter sphere.
3. Solid barriers, which do not have openings, such as a masonry or stone wall, should not contain indentations or protrusions except for normal construction tolerances and tooled masonry joints.
4. Where the barrier is composed of horizontal and vertical members and the distance between the tops of the horizontal members is less than 45 inches, the horizontal members should be located on the swimming pool side of the fence. Spacing between vertical members should not exceed 1-3/4 inches in width. Where there are decorative cutouts, spacing within the cutouts should not exceed 1-3/4 inches in width.
5. Where the barrier is composed of horizontal and vertical members and the distance between the tops of the horizontal members is 45 inches or more, spacing between vertical members should not exceed 4 inches. Where there are decorative cutouts, spacing within the cutouts should not exceed 1-3/4 inches in width.
6. Maximum mesh size for chain link fences should not exceed 1-1/4 inch square unless the fence is provided with slats fastened at the top or the bottom which reduce the openings to no more than 1-3/4 inches.
7. Where the barrier is composed of diagonal members, such as a lattice fence, the maximum opening formed by the diagonal members should be no more than 1-3/4 inches.
8. Access gates to the pool should comply with Section I, Paragraphs 1 through 7, and should be equipped to accommodate a locking device. Pedestrian access gates should open outward, away from the pool, and should be self-closing and have a self-latching device. Gates other than pedestrian access gates should have a self-latching device. Where the release mechanism of the self-latching device is located less than 54 inches from the bottom of the gate, (a) the release mechanism should be located on the pool side of the gate at least 3 inches below the top of the gate and (b) the gate and barrier should have no opening greater than 1/2 inch within 18 inches of the release mechanism.
9. Where a wall of a dwelling serves as part of the barrier, one of the following should apply:
 - (a) All doors with direct access to the pool through that wall should be equipped with an alarm which produces an audible warning when the door and its screen, if present, are opened. The alarm should sound continuously for a minimum of 30 seconds within 7 seconds after the door is opened. Alarms should meet the requirements of UL 2017 General-Purpose Signaling Devices and Systems, Section 77. The alarm should have a minimum sound pressure rating of 85 dBA at 10 feet and the sound of the alarm should be distinctive from other household sounds, such as smoke alarms, telephones, and door bells. The alarm should automatically reset under all conditions. The alarm should be equipped with manual means, such as touchpads or switches, to temporarily deactivate the alarm for a single opening of the door from either direction. Such deactivation should last for no more than 15 seconds. The deactivation touchpads or switches should be located at least 54 inches above the threshold of the door.
 - (b) The pool should be equipped with a power safety cover which complies with ASTM F1346-91 listed below.
 - (c) Other means of protection, such as self-closing doors with self-latching devices, are acceptable so long as the degree of protection afforded is not less than the protection afforded by (a) or (b) described above.
10. Where an aboveground pool structure is used as a barrier or where the barrier is mounted on top of the pool structure, and the means of access is a ladder or steps, then (a) the ladder to the pool or steps should be capable of being secured, locked or removed to prevent access, or (b) the ladder or steps should be surrounded by a barrier. When the ladder or steps are secured, locked, or removed, any opening created should not allow the passage of a 4-inch diameter sphere. Barriers should be located so as to prohibit permanent structures, equipment or similar objects from being used to climb the barriers.

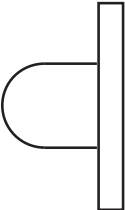
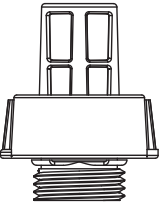
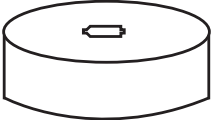
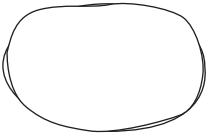
PARTS LIST		
1 	2 	3 
4 	5 	6 
7 	8 	9  * Optional
10  * Optional	11 	12 
13 	14  * Optional	

NOTE: Drawings for illustration purpose only. Actual product may vary. Not to scale.

PARTS REFERENCE

Before assembling your product, please take a few minutes to check the contents and become familiar with all the parts.

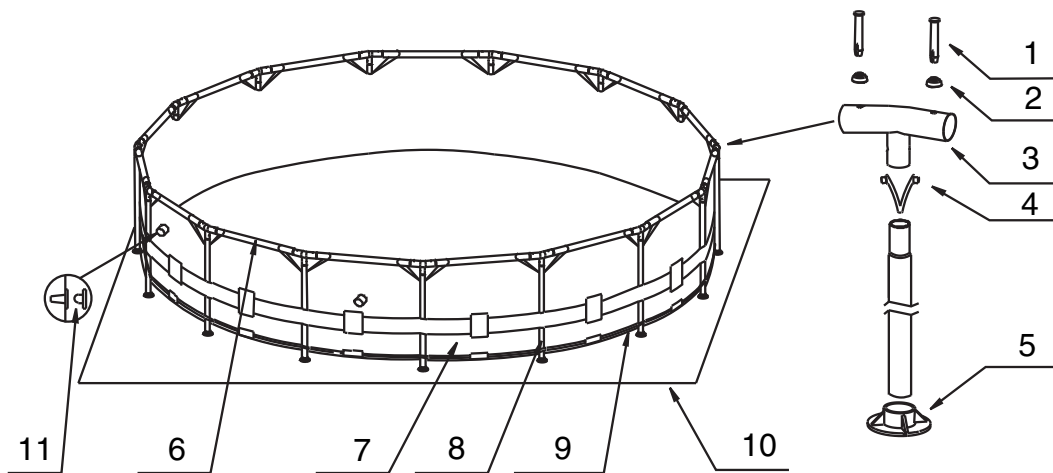

NOTE: Drawings for illustration purpose only. Actual product may vary. Not to scale.

10' (305 cm), 12' (366 cm), 13' (396 cm), 14' (427 cm), 15' (457 cm) & 16' (488 cm) models
(The number of pieces will vary depending on the pool size)

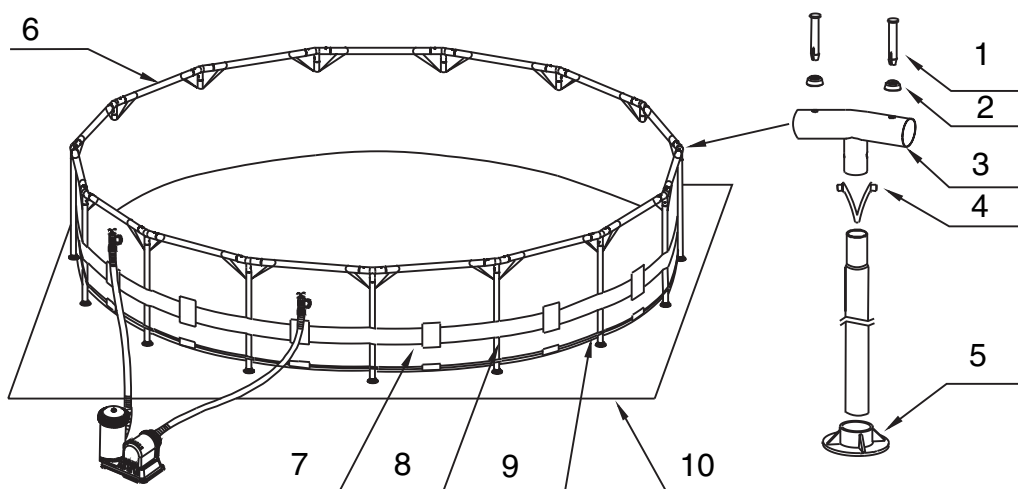

NOTE: Drawings for illustration purpose only. Actual product may vary. Not to scale.

18' (549 cm) & 24' (732 cm) models
(The number of sides may vary depending on the pool size)

PARTS REFERENCE

English

87PO

REF NO.	DESCRIPTION	POOL SIZE & QUANTITIES									
		10' (305cm)	12' (366cm)	13' (396cm)	14' (427cm)	15' (457cm)	16' (488cm)	18' (549cm)	24' (732cm)		
1	PIN (WITH 2 EXTRA)	22	26	28	30	32	34	38	50		
2	SEAL (WITH 2 EXTRA)	22	26	28	30	32	34	38	50		
3	T - JOINT	10	12	13	14	15	16	18	24		
4	SPRING PIN	10	12	13	14	15	16	18	24		
5	LEG CAP	10	12	13	14	15	16	18	24		
6	HORIZONTAL BEAM	10	12	13	14	15	16	18	24		
7	POOL LINER (DRAIN VALVE CAP INCLUDED)	1	1	1	1	1	1	1	1		
8	VERTICAL LEG (SPRING PIN INCLUDED)	10	12	13	14	15	16	18	24		
9	RESTRAINING ROPE (OPTIONAL)			1	1	1	1	1	1		
10	GROUND CLOTH (OPTIONAL)					1	1	1	1		
11	STRAINER HOLE PLUG (WITH 1 EXTRA)	3	3	3	3	3	3				
12	DRAIN CONNECTOR	1	1	1	1	1	1	1	1		
13	DRAIN VALVE CAP	1	1	1	1	1	1	2	2		
14	POOL COVER (OPTIONAL)			1	1	1	1	1	1		

PARTS REFERENCE

PARTS REFERENCE

REF NO.	DESCRIPTION	10' X 30" (305cm X 76cm)	12' X 30" (366cm X 76cm)	12' X 33" (366cm X 84cm)	12' X 36" (366cm X 91cm)	12' X 39" (366cm X 99cm)	13' X 42" (396cm X 107cm)	13' X 39" (396cm X 99cm)
		SPARE PART NO.						
1	PIN (WITH 2 EXTRA)	10426	10426	10426	10426	10426	10312	10312
2	SEAL (WITH 2 EXTRA)	10648	10648	10648	10648	10648	10648	10648
3	T - JOINT	10463	10424	10424	10424	10424	11126	11126
4	SPRING PIN	10313	10313	10313	10313	10313	10313	10313
5	LEG CAP	10576	10576	10576	10576	10576	10309	10309
6	HORIZONTAL BEAM	10618	10618	10618	10618	10618	10414	10414
7	POOL LINER (DRAIN VALVE CAP INCLUDED) <BLUE> OR POOL LINER (DRAIN VALVE CAP INCLUDED) <GREY>	10615	10616	11295	10879	11213	11141	11327
8	VERTICAL LEG (SPRING PIN INCLUDED)	10619	10619	11296	10880	11214	10589	11309
9	RESTRAINING ROPE (OPTIONAL)						10587	10587
10	GROUND CLOTH (OPTIONAL)							
11	STRAINER HOLE PLUG (WITH 1 EXTRA)	10127	10127	10127	10127	10127	10127	10127
12	DRAIN CONNECTOR	10184	10184	10184	10184	10184	10184	10184
13	DRAIN VALVE CAP	10649	10649	10649	10649	10649	10649	10649
14	POOL COVER (OPTIONAL)						11142	11142

REF NO.	DESCRIPTION	14 X 42" (427cm X 107cm)	15' X 36" (457cm X 91cm)	15' X 42" (457cm X 107cm)	15' X 48" (457cm X 122cm)	16' X 48" (488cm X 122cm)	18' X 48" (549cm X 122cm)	18' X 52" (549cm X 132cm)	24' X 52" (732cm X 132cm)
		SPARE PART NO.							
1	PIN (WITH 2 EXTRA)	10312	10312	10312	10312	10312	10312	10312	10312
2	SEAL (WITH 2 EXTRA)	10648	10648	10648	10648	10648	10648	10648	10648
3	T - JOINT	10310	10310	10310	10861	10861	10861	10862	10863
4	SPRING PIN	10313	10313	10313	10313	10313	10313	10313	10313
5	LEG CAP	10309	10309	10309	10309	10309	10309	10309	10309
6	HORIZONTAL BEAM	10414	10414	10414	10414	10414	10414	10414	10414
7	POOL LINER (DRAIN VALVE CAP INCLUDED) <BLUE> OR POOL LINER (DRAIN VALVE CAP INCLUDED) <GREY>	10987	10584	10585	10586	10764	10314	10766	10767
8	VERTICAL LEG (SPRING PIN INCLUDED)	10589	10590	10589	10864	10864	10864	10865	11043
9	RESTRAINING ROPE (OPTIONAL)	10587	10587	10587	10587	10317	10317	10317	10865
10	GROUND CLOTH (OPTIONAL)	10127	18932	18932	18932	18927	18933	18933	10420
11	STRAINER HOLE PLUG (WITH 1 EXTRA)	10184	10184	10184	10184	10127	18933	18933	18935
12	DRAIN CONNECTOR	10649	10649	10649	10184	10184	10184	10184	10184
13	DRAIN VALVE CAP	11054	18901	18901	11044	11044	11044	11044	10184
14	POOL COVER (OPTIONAL)				18901	10754	18937	18937	18929

POOL SETUP

IMPORTANT SITE SELECTION AND GROUND PREPARATION INFORMATION

WARNING

- The pool location must allow you to secure all doors, windows, and safety barriers to prevent unauthorized, unintentional or unsupervised pool entry.
- Install a safety barrier that will eliminate access to the pool for young children and pets.
- Failure to set up the pool on flat, level, compact ground and to assemble, and fill with water in accordance with the following instructions could result in the pool's collapse or the possibility that a person lounging in the pool could be swept out/ejected, resulting in serious injury or property damage.
- Risk of electric shock: connect the filter pump only to a grounding type receptacle protected by a ground-fault circuit interrupter (GFCI). To reduce risk of electric shock, do not use extension cords, timers, plug adapters or converter plugs to connect the pump to an electric supply. Always provide a properly located outlet. Locate cord where it cannot be damaged by lawn mowers, hedge trimmers, and other equipment. See the filter Pump manual for additional warnings and instructions.

Select an outdoor location for the pool with the following requirements in mind:

1. The area where the pool is to be set up must be **absolutely flat and level**.
Do not set up the pool on a slope or inclined surface.
2. The ground surface must be compacted and firm enough to withstand the pressure and weight of a fully set up pool. **Do not** set up the pool on mud, sand, soft or loose soil conditions.
3. **Do not** set up the pool on a deck, balcony or platform.
4. The pool requires at least 4 feet of space all around pool from objects that a child could climb on to gain access to the pool.
5. The chlorinated poolwater could damage the surrounding vegetation. Certain types of grass such as St. Augustine and Bermuda, may grow through the liner. Grass growing through the liner it is not a manufacture defect and is not covered under warranty.

POOL SETUP (continued)

You may have purchased this pool with the Intex Krystal Clear™ filter pump. The pump has its own separate set of installation instructions. First assemble your pool unit and then set up the filter pump.

Estimated assembly time 30-60 minutes. (Note the assembly time is only approximate and individual assembly experience may vary.)

1. Liner preparation

- Find a flat, level location that is free and clear of stones, branches or other sharp objects that may puncture the pool liner or cause injury.
- Open the carton containing the liner, joints, legs, etc., very carefully as this carton can be used to store the pool during the winter months or when not in use.

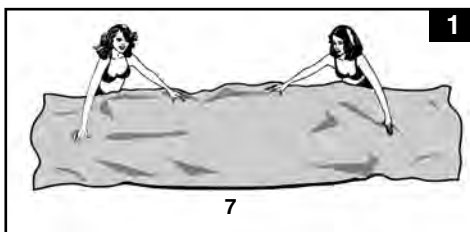

- Take out the ground cloth (10) (optional) and spread it over the cleared area. Then take out the liner (7) and spread it out over the ground cloth, with the drain valve directed towards the draining area. Place the drain valve away from the house. Allow the sun to warm up the liner before inserting the beams (6) into the sleeve openings.

IMPORTANT: Always set up the pool unit with at least 2 persons. Do not drag the liner across the ground as this can cause liner damage and pool leakage (see drawing 1).

- During the setup of this pool liner, point the hose connections or openings in the direction of the electric power source. The outer edge of the pool should be within reach of the pump's electrical connection.

2. Frame assembly

- The frame pool's legs (8) and beams (6) fall into two groups. The larger diameters are the horizontal beams that are slid (pushed) into the sleeve openings at the top of the liner. The smaller diameters are the vertical legs. Both these legs and beams fit into the T-joints (3).

- Starting at any location, but always working in the same direction, push the horizontal beam into the sleeve. Once the beam is centered take one of the T-joints and using the connection pin (1), attach the joint to one end of the beam by inserting the pin through the seal (2) and in the pre-drilled holes. Repeat this procedure in a circular fashion until all the beams and joints have been connected (see drawing 2.1).

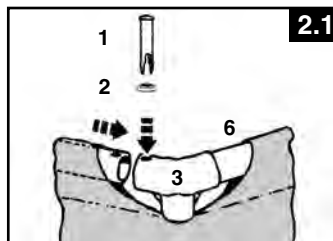

The last joint connection may be difficult to complete. You can do it though, if you first simultaneously raise the last joint and beam more than 2 inches (5 cm). Now insert the beam into the joint while lowering the pieces into position. The beam will easily slide into the joint (see drawing 2.2). Ensure that the last joint is fully connected before proceeding to connecting the legs.

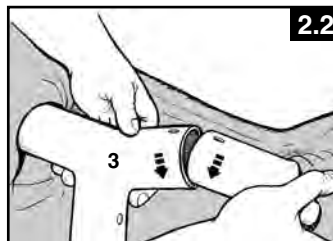

POOL SETUP (continued)

- Next slide the vertical legs into the belt loop located in the middle of the pool liner. The bottom of the leg should be inside the white restraining rope (9) (optional) located near the liner's bottom edge. Exceptions are the 10' (305cm) and 12' (366cm) size pools. Carefully slide the leg into the belt loop and place the leg's bottom inside the rope and then insert the top of the leg into the bottom of the joint. Snap this leg into joint's holes by aligning the holes and the spring-loaded pin. Attach the leg's end cap (5) to the bottom of the leg (see drawings 3.1 & 3.2).

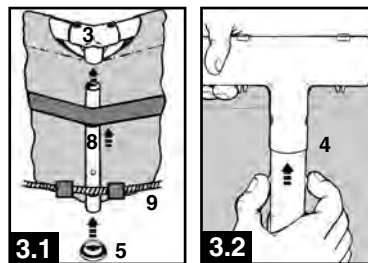

- Upon connecting the last leg, grab hold of the frame pool's top beams in 2 – 3 locations. Shake the pool to be sure that all the joints, legs and beams fit into each other. Ensure that all pins are in position by pushing them downwards through the holes (see drawing 4.1).

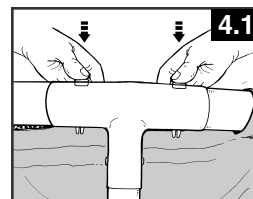

- Pull gently, in an outward direction, the bottom of each leg; making sure the leg is inside the restraining rope. The leg is to end up in an upright vertical position.

3. Filling of the pool

- The following applies to pool liners **with** hose connectors (16' (488 cm) & below pools). If the pool was purchased **without** a filter pump, insert two of the three plugs (11) into the black filter pump outlets. Do this from the inside of the pool so that water will not run out when filling it.

If the pool was purchased **with** a filter pump, read the Krystal Clear™ Filter Pump Manual first and **then** proceed to next installation step.

- Before filling the pool with water, ensure that the drain plug inside the pool is closed and that the drain cap on the outside is screwed on tightly. Fill the pool with no more than 1 inch (2.5 cm) of water. Check to see whether the water is level. **IMPORTANT: If the water in the pool flows to one side, the pool is not completely level. Setting up the pool on unlevel ground will cause the pool to tilt resulting in the sidewall material bulging and a potential collapse of the pool. If the pool is not completely level, you must drain the pool, level the area or move the pool to a different area that is level, and re-fill the pool, following the above directions.**

- Smooth out the bottom liner wrinkles (from inside the pool) by pushing out where the pool floor and pool sides meet. Or, (from outside pool) reach under the side of the pool, grasp the pool floor and pull in an outward direction. If the ground cloth is causing the wrinkles, have 2 adults pull from opposite sides to remove all wrinkles. Use the properly assembled pool ladder when entering or exiting the pool during this process.

- Fill the pool with water up to just below the sleeve line. (see drawing 4.2).

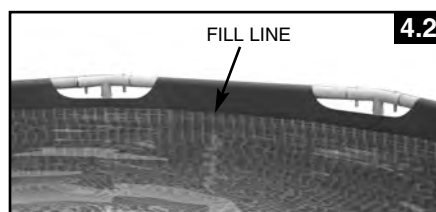

4. Posting aquatic safety signs

Select a highly visible area near the pool to post the Danger No Diving or Jumping sign included later in this manual.

IMPORTANT

Before allowing anyone to use the pool, hold a family meeting. Establish a set of rules that include, at a minimum, the important safety rules and general aquatic safety information in this manual. Review these rules on a regular basis and with all users of the pool, including guests.

POOL MAINTENANCE & CHEMICALS

⚠ WARNING

REMEMBER TO

- Protect all pool occupants from possible water-related illnesses by keeping the pool water clean and sanitized. Do not swallow the pool water. Always practice good hygiene.
- Keep your pool clean and clear. The pool floor must be visible at all times from the outside barrier of the pool.
- Keep children away from pool covers to avoid entanglement, drowning, or other serious injury.

Water maintenance

The maintenance of a proper water balance through appropriate use of sanitizers is the single most important factor in maximizing the life and appearance of the liner as well as ensuring clean, healthy and safe water. Proper technique is important for water testing and treating the pool water. See your pool professional for chemical, test kits and testing procedures. Be sure to read and follow the written instructions from the chemical manufacturer.

1. Never let chlorine come in contact with the liner if it is not completely dissolved. Dissolve granular or tablet chlorine first in a bucket of water, then add it to the pool water. Likewise with liquid chlorine; mix it immediately and thoroughly with the pool water.
2. Never mix chemicals together. Add the chemicals to the pool water separately. Thoroughly dissolve each chemical before adding another one to the water.
3. An Intex pool skimmer and an Intex pool vacuum are available to assist in maintaining clean pool water. See your pool dealer for these pool accessories.
4. Do not use a pressure washer to clean the pool.

TROUBLESHOOTING

PROBLEM	DESCRIPTION	CAUSE	REMEDY
ALGAE	<ul style="list-style-type: none"> • Greenish water. • Green or black spots on pool liner. • Pool liner is slippery and/or has a bad odor. 	<ul style="list-style-type: none"> • Chlorine and pH levels need adjustment. 	<ul style="list-style-type: none"> • Super chlorinate with shock treatment. Correct pH to your pool store's recommended level. • Vacuum pool bottom. • Maintain proper chlorine level.
COLORED WATER	<ul style="list-style-type: none"> • Water turns blue, brown, or black when first treated with chlorine. 	<ul style="list-style-type: none"> • Copper, iron or manganese in water being oxidized by the added chlorine. 	<ul style="list-style-type: none"> • Adjust pH to recommended level. • Run filter until water is clear. • Replace cartridge frequently.
SUSPENDED MATTER IN WATER	<ul style="list-style-type: none"> • Water is cloudy or milky. 	<ul style="list-style-type: none"> • "Hard water" caused by pH level being too high. • Chlorine content is low. • Foreign matter in water. 	<ul style="list-style-type: none"> • Correct the pH level. Check with your pool dealer for advice. • Check for proper chlorine level. • Clean or replace your filter cartridge.
CHRONIC LOW WATER LEVEL	<ul style="list-style-type: none"> • Level is lower than on previous day. 	<ul style="list-style-type: none"> • Rip or hole in pool liner or hoses. Tighten caps. 	<ul style="list-style-type: none"> • Repair with patch kit. • Finger tighten all caps. • Replace the hoses.
SEDIMENT ON POOL BOTTOM	<ul style="list-style-type: none"> • Dirt or sand on pool floor. 	<ul style="list-style-type: none"> • Heavy use, getting in and out of pool. 	<ul style="list-style-type: none"> • Use Intex pool vacuum to clean bottom of pool.
SURFACE DEBRIS	<ul style="list-style-type: none"> • Leaves, insects etc. 	<ul style="list-style-type: none"> • Pool too close to trees. 	<ul style="list-style-type: none"> • Use Intex pool skimmer.

POOL MAINTENANCE & DRAINAGE



CAUTION

ALWAYS FOLLOW THE CHEMICAL MANUFACTURER'S DIRECTIONS, AND THE HEALTH AND HAZARD WARNINGS.

Do not add chemicals if the pool is occupied. This can cause skin or eye irritation. Concentrated chlorine solutions can damage the pool liner. In no event is Intex Recreation Corp., Intex Development Co. Ltd., their related companies, authorized agents and service centers, retailers or employees liable to the buyer or any other party for costs associated with the loss of pool water, chemicals or water damage. **Keep spare filter cartridges on hand. Replace cartridges every two weeks. We recommend that a Krystal Clear™ Intex Filter Pump be used with all of our above-ground-pools. To purchase an Intex Filter Pump or other accessories see your local retailer, visit our website or call the Intex Consumer Services Department at the number below and have your Visa or Mastercard ready.**

www.intexcorp.com

1-800-234-6839

Consumer Service 8:30 am to 5:00 pm PT (Mon.-Fri.)

EXCESSIVE RAIN: To avoid damage to the pool and over filling, immediately drain rain water that causes the water level to be higher than the maximum.

How to Drain Your Pool and Long Term Storage

1. Check local regulations for specific directions regarding disposal of swimming pool water.
2. Check to make sure that the drain plug inside the pool is plugged in place.
3. Remove the cap from the drain valve on the outside pool wall.
4. Attach the female end of the garden hose to the drain connector (12).
5. Place the other end of the hose in an area where the water can be safely drained away from the house and other nearby structures.
6. Attach the drain connector to the drain valve. **NOTE: The drain connector will push the drain plug open inside the pool and water will start to drain immediately.**
7. When the water stops draining, start lifting the pool from the side opposite the drain, leading any remaining water to the drain and emptying the pool completely.
8. Disconnect hose and adapter when finished.
9. Re-insert drain plug in drain valve on inside of pool for storage.
10. Replace drain cap on outside of pool.
11. Reverse set up instructions to disassemble the pool, and remove all connecting parts.
12. Be sure that the pool and all parts are completely dry before storage. Air dry the liner in the sun for an hour before folding (see drawing 5). Sprinkle some talcum powder to prevent the vinyl from sticking together and to absorb any residual moisture.
13. Create a square shape. Starting at one side, fold one-sixth of liner in on itself twice. Do the same on the opposite side (see drawing 6.1 & 6.2).
14. Once you have created two opposing folded sides, simply fold one over the other like closing a book (see drawing 7.1 & 7.2).
15. Fold the two long ends to the middle (see drawing 8).
16. Fold one over the other like closing a book and finally compact the liner (see drawing 9).
17. Store the liner and accessories in a dry, temperature controlled, between 32 degrees Fahrenheit (0 degrees Celsius) and 104 degrees Fahrenheit (40 degrees Celsius), storage location.
18. The original packing can be used for storage.

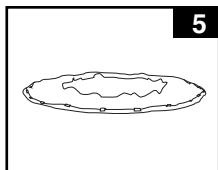

5

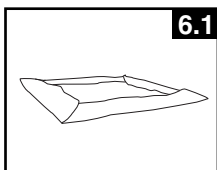

6.1

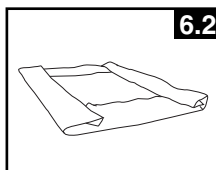

6.2

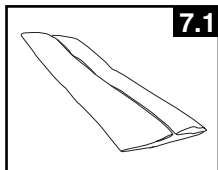

7.1

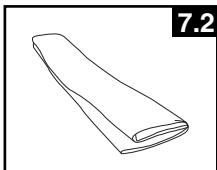

7.2

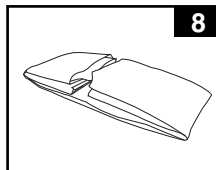

8

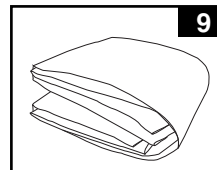

9

STORAGE

WINTER PREPARATIONS

Winterizing your Above Ground Pool

After usage, you can easily empty and store away your pool in a safe place. Some pool owners, however, choose to leave their pool up all year round. In cold areas, where freezing temperatures occur, there can be a risk of ice damage to your pool. We therefore recommend you drain, disassemble and properly store the pool, when the temperature drops below 32 degrees Fahrenheit (0 degrees Celsius). Also see the section "How To Drain Your Pool".

Should you choose to leave your pool out, prepare it as follows:

1. Clean the pool water thoroughly. If the type is an Easy Set Pool or an Oval Frame Pool, make sure that the top ring is properly inflated.
2. Remove the skimmer (if applicable) or any accessories attached to the threaded strainer connector. Replace strainer grid if necessary. Be sure all accessories parts are clean and completely dry before storage.
3. Plug the Inlet and Outlet fitting from the inside of the pool with the plug provided (sizes 16' and below). Close the Inlet and Outlet Plunger Valve (sizes 17' and above).
4. Remove the ladder (if applicable) and store in a safe place. Be sure the ladder is completely dry before storage.
5. Remove the hoses that connect the pump and filter to the pool.
6. Add the appropriate chemicals for the winter period. Consult your local pool dealer as to which chemicals you should use and how to use them. This can vary greatly by region.
7. Cover pool with Intex Pool Cover. **IMPORTANT NOTE: INTEX POOL COVER IS NOT A SAFETY COVER.**
8. Clean and drain the pump, filter housing and hoses. Remove and discard the old filter cartridge. Keep a spare cartridge for the next season.
9. Bring pump and filter parts indoors and store in a safe and dry area, preferably between 32 degrees Fahrenheit (0 degrees Celsius) and 104 degrees Fahrenheit (40 degrees Celsius).

STORAGE

GENERAL AQUATIC SAFETY

Water recreation is both fun and therapeutic. However, it involves inherent risks of injury and death. To reduce your risk of injury, read and follow all product, package and package insert warnings and instructions. Remember, however, that product warnings, instructions and safety guidelines cover some common risks of water recreation, but do not cover all risks and dangers.

For additional safeguards, also familiarize yourself with the following general guidelines as well as guidelines provided by nationally recognized Safety Organizations:

- Demand constant supervision. A competent adult should be appointed as a "lifeguard" or water watcher, especially when children are in and around the pool.
- Learn to swim.
- Take the time to learn CPR and first aid.
- Instruct anyone who is supervising pool users about potential pool hazards and about the use of protective devices such as locked doors, barriers, etc.
- Instruct all pool users, including children what to do in case of an emergency.
- Always use common sense and good judgement when enjoying any water activity.
- Supervise, supervise, supervise.

For additional information on safety, please visit

- The Association of Pool and Spa Professionals: The Sensible Way to Enjoy Your Aboveground/Onground Swimming Pool www.nspi.org
- American Academy of Pediatrics: Pool Safety for Children www.aap.org
- Red Cross www.redcross.org
- Safe Kids www.safekids.org
- Home Safety Council: Safety Guide www.homesafetycouncil.org
- Toy Industry Association: Toy Safety www.toy-tia.org

SAFETY IN YOUR POOL

Safe swimming depends on constant attention to the rules. The "NO DIVING" sign within this manual can be posted near your pool to help keep everyone alert to the danger. You may also wish to copy and laminate the sign for protection from the elements.

POST THIS WARNING NEAR YOUR POOL

WARNING

NO DIVING OR JUMPING SHALLOW WATER

DIVING MAY RESULT IN PERMANENT INJURY OR DEATH

- Be Safe. Swim with a friend.
- Children must be accompanied by an adult.
- Don't swim when using alcohol or drugs.
- Be familiar with the pool before swimming.
- No running, jumping, or horseplay in or around pool.
- No glass in pool area.



TO AVOID SERIOUS INJURY ALL POOL USERS MUST KNOW AND FOLLOW THESE SAFETY RULES.

COUNTRIES/REGIONS**SERVICE CENTER LOCATIONS**

- UNITED STATES
- CANADA

INTEX RECREATION CORP.
 1665 Hughes Way
 Long Beach, CA 90801
 Tel: 1-800-234-6839
 Fax: 310-549-2900
 Website: www.intexcorp.com (U.S./Canada only)
 Consumer Service Hours: 8:30 am to 5:00 pm
 Pacific Time, Mon. thru Fri. only.

- MEXICO

KAY INTERNACIONAL, S.A. DE C.V.
 SAN JERONIMO # 550- INT.501 Y 502. COL.
 JARDINES DEL PEDREGAL. C.P. 01900
 MÉXICO D.F.
 Tel: 01-800-347-4020 (Collect Call)
 Tel: 55-9172-8035
 Fax: 55-9172-8047
 E-mail: servicenter@kayinternacional.com
 Website: www.intexmexico.com.mx

- PANAMA
- PARAGUAY
- ECUADOR
- HONDURAS
- EL SALVADOR
- NICARAGUA

**SUPRO MUNDIAL S.A./
 PRODUCTOS SUPERIORES S.A.**
 Boulevard Andrews, Albrook,
 Panama, Rep. of Panama
 Tel: 507-300-3800
 Fax: 507-300-3813
 E-mail: suproadmin@supropanama.com

- COSTA RICA
- DOMINICAN REPUBLIC
- GUATEMALA
- COLOMBIA
- VENEZUELA

CENTURY USA, LLC
 4731 W. Atlantic Ave., Suite B-3
 Delray Beach, FL 33445, USA
 Tel: 561-495-0648
 Fax: 561-495-4782
 E-mail: sales@centuryusa.com

- MIDDLE EAST REGION
 REGION

FIRST GROUP INTERNATIONAL
 AL MOOSA GROUP BUILDING, 1ST FLOOR,
 OFFICE 102 & 103, UMM HURAIR ROAD,
 KARAMA, DUBAI, UAE
 TEL: 00971-4-800INTEX(46839) / +971-4-3373322
 FAX: 00971-4-3375115
 E-mail: intex@firstgroupinternational.com
 Website: www.firstgroupinternational.com

- ASIA

INTEX DEVELOPMENT CO. LTD.
 9th Floor,
 Dah Sing Financial Centre
 108 Gloucester Road,
 Wanchai, Hong Kong
 Tel: 852-28270000
 Fax: 852-23118200
 E-mail: xmservicesupport@intexcorp.com.cn
 Website: www.intexdevelopment.com

For answers to most frequently asked questions, please visit www.intexcorp.com.
 Non U.S. Residents, please visit www.intexdevelopment.com.

English

®
INTEX

For Residents of the U.S. & Canada:

INTEX RECREATION CORP.

Attn: Consumer Service

1665 Hughes Way

Long Beach, CA 90801

Phone: 1-800-234-6839

Fax: (310) 549-2900

Consumer Service Hours:

8:30 am to 5:00 pm Pacific time

Monday thru Friday only

Website: www.intexcorp.com

***For Residents outside of the U.S. and Canada:
Please refer to the Service Center Locations***

©2011 Intex Marketing Ltd. - Intex Development Co. Ltd.
- Intex Trading Ltd. - Intex Recreation Corp.

All rights reserved/Tous droits réservés/Todos los

derechos reservados/Alle Rechte vorbehalten.

Printed in China/Imprimé en Chine/Impreso en

China/Gedruckt in China.

®™ Trademarks used in some countries of the world under
license from/®™ Marques utilisées dans certains pays sous
licence de/Marcas registradas utilizadas en algunos países
del mundo bajo licencia de/Warenzeichen verwendet in
einigen Ländern der Welt in Lizenz von/Intex Marketing Ltd.
to/à/a/an Intex Trading Ltd., Intex Development Co. Ltd.,
G.P.O Box 28829, Hong Kong & Intex Recreation Corp.,
P.O. Box 1440, Long Beach, CA 90801 • Distributed in the
European Union by/Distribué dans l'Union Européenne
par/Distribuido en la unión Europea por/Vertrieb in der
Europäischen Union durch/Intex Trading B.V., P.O. Box nr.
1075 - 4700 BB Roosendaal - The Netherlands

**INTEX®**