



REFRIGERATOR
Use and Care Guide

Model No.:
WHR31TS4E

CUSTOMER SERVICE NUMBER

In the U.S. 1-855-666-4477

KEEP THIS GUIDE FOR FUTURE REFERENCE!
Warrantor: Zhongshan Galanz Consumer
Electric Appliances Co., Ltd, Guangdong 528428

®/™ ©2020 Whirlpool. All rights reserved. Manufactured under license by Galanz-Zhongshan Galanz Consumer Electric Appliances Co., Ltd., Guangdong, China. Limited warranty provided by manufacturer.

To ensure proper use of this appliance and for your safety, please read the following instructions completely before operating this appliance.

TABLE OF CONTENTS

Refrigerator safety	1
Important safety instructions.....	1
Disposal of the refrigerator.....	2
Grounding instructions	2
Location requirements	3
Installation instructions.....	3
Operating instructions.....	4
Parts and features.....	5
Specifications.....	6
Cleaning.....	7
Defrosting.....	7
Power Failure.....	8
Vacation.....	8
Moving the refrigerator.....	9
Reversing the door.....	10
Replacement of interior light	11
Troubleshooting tips.....	12
Assistance.....	14
Limited warranty.....	14

REFRIGERATOR SAFETY

Your safety and the safety of others are very important.

We have provided many important safety messages in this manual and on your appliance. Always read and obey all safety messages.



This is the safety alert symbol.

This symbol alerts you to potential hazards that can kill or hurt you and others.

All safety messages will follow the safety alert symbol and either the word “DANGER” or “WARNING.”

These words mean:

! DANGER

You can be killed or seriously injured if you don't immediately follow instructions.

! WARNING

You can be killed or seriously injured if you don't follow instructions.

All safety messages will tell you what the potential hazard is, tell you how to reduce the chance of injury, and tell you what can happen if the instructions are not followed.

IMPORTANT SAFETY INSTRUCTIONS

When using electrical appliances, basic safety precautions should always be followed to reduce the risk of explosion, fire, electrical shock, and/or injury to persons, including the following:
Read all instructions before using the appliance.

1. This appliance must be grounded. Connect only to properly grounded outlet. See Important Grounding Instructions on page 3.
2. Install or locate this refrigerator only in accordance with the provided Installation Instructions.
3. To protect against electric shock, do not place cord, plug, or refrigerator in water or other liquid.
4. The refrigerant of this product is R600a, which is flammable. Make sure not to damage the cooling system during the transportation and installation.
5. Please note that servicing shall be done by factory authorized service personnel, so as to minimize the risk of possible ignition due to incorrect parts or improper service.

SAVE THESE INSTRUCTIONS

DISPOSAL OF THE REFRIGERATOR

WARNING

Suffocation Hazard
Remove door from your old refrigerator.
Failure to do so can result in death or brain damage.

Before you throw away your old refrigerator:

1. Take off the doors.
2. Leave the shelf racks in place so that children may not easily climb inside.

Refrigerants

All refrigeration products contain refrigerants, which under federal law must be removed prior to product disposal. If you are getting rid of an old refrigeration product, check with a qualified disposal company for instructions.

GROUNDING INSTRUCTIONS

WARNING



Electrical Shock Hazard
Plug into a grounded 3 prong outlet.
Do not remove ground prong.
Do not use an adapter.
Do not use an extension cord.
Failure to follow these instructions can result in death, fire, or electrical shock.

This appliance must be grounded due to the event of an electrical short circuit. This appliance is equipped with a grounded wire and a grounded plug. Refrigerator must be plugged into a properly installed grounded 3 prong outlet.

Consult a qualified electrician or service technician if the grounding instructions are not completely understood or if doubt exists as to whether the appliance is properly grounded.

Three-pronged
(grounding) plug

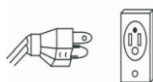

Properly polarized and
grounded outlet

LOCATION REQUIREMENTS

WARNING



Explosion Hazard
Keep flammable materials and vapors, such as gasoline, away from refrigerator.
Failure to do so can result in death, explosion, or fire.

1. It is recommended not to install the refrigerator near an oven, radiator, or other heat source.
2. Do not install in a location where the temperature will fall below 55 °F (13 °C). For best performance, do not install the refrigerator behind a cabinet door.
3. The refrigerator should be located on a firm, flat surface that is strong enough to support the refrigerator when it is fully loaded.
4. Leave a minimum of 1/2" (1.27 cm) between each side of the appliance and the wall. The top and back of the appliance should have a minimum 1 1/2" (3.81 cm) clearance. This allows for proper air circulation. This appliance is intended to be free-standing and should not be built-in or placed in a recessed area.
5. The refrigerator legs must be adjusted during installation in order to function properly. The leveling legs on the front corners can be adjusted by turning clockwise to raise the appliance, and counter-clockwise to lower it. Be sure to have the appliance sloped slightly backward to ensure that the door closes tightly.
6. Do not put the unit in a place where it is subjected to sunlight.
7. Do not put the unit in a place where the ambient temperature is more than 90 °F (32 °C).

INSTALLATION INSTRUCTIONS

WARNING

Excessive Weight Hazard
Use two or more people to move and install refrigerator.
Failure to do so can result in back or other injury.

Before using the refrigerator for the first time, remove all of the packing materials, including the foam base and adhesive tape holding accessories in place.

OPERATING INSTRUCTIONS

⚠ WARNING



Electrical Shock Hazard
Plug into a grounded 3 prong outlet.
Do not remove ground prong.
Do not use an adapter.
Do not use an extension cord.
Failure to follow these instructions can result in death, fire, or electrical shock.

1. Allow refrigerator to stand upright for 4 hours before using.
2. Plug refrigerator into a grounded 3 prong outlet. (See "Grounding instructions").
3. The temperature of refrigerator can be controlled manually by the knob. Setting "OFF" means no cooling, but does not shut off the power of the refrigerator. Setting "MAX" is the coolest possible temperature setting. Normally "MED" setting is advised. If you want the temperature warmer, please turn the knob to "MIN".
4. Food should be kept in sealed containers to prevent odors or drying.
5. Hot food should be cooled down before placing into the appliance to prevent Increase in interior temperature and power consumption. Placing food inside too soon will impact the performance.
6. It is recommended not to open the door frequently to minimize the power consumption.

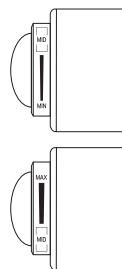

PARTS AND FEATURES

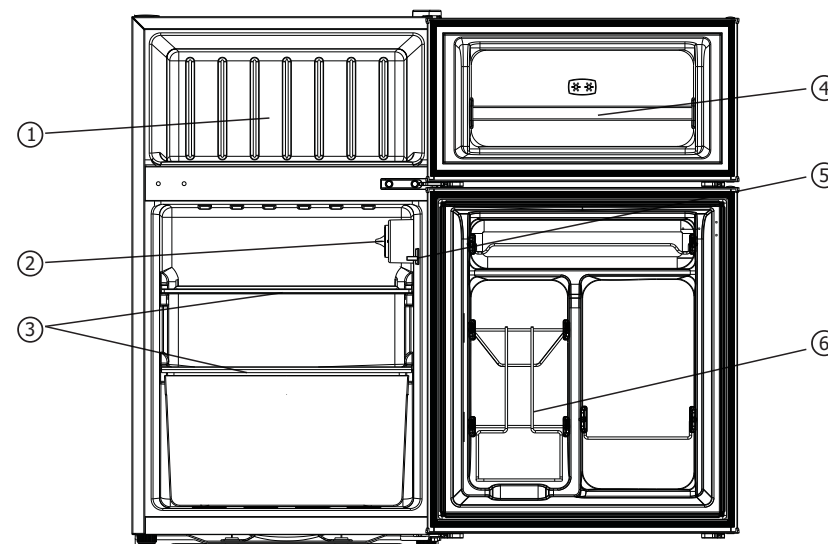

- ① Freezer compartment
- ② Lamp and temperature control knob
- ③ Glass shelf
- ④ Rod
- ⑤ Lamp switch
- ⑥ Steel tube

SPECIFICATIONS

Model	WHR31TS4E	
Electric shock protection type	I	
Capacity (cu.ft)	3.1	
Voltage (V)	120	
Frequency (Hz)	60	
Current (A)	0.8	
Sound [dB]	≤ 42	
Energy Consumption (kwh/24h)	0.88	
Refrigerant	R600a/0.85oz	
Net weight (lbs)	52.9	
Interior temperature (F)	32~46.4	
Dimension (Inches)	Width	19.13
	Depth	21.10
	Height	32.79

CLEANING



Interior

- Clean the interior of the appliance with a mixture of warm water and baking soda, use about 1-2 tablespoons per quart of water.
- Use a sponge or soft cloth and make sure to wipe excess moisture out before cleaning around the controls.
- Rinse thoroughly with warm water and dry with a clean soft cloth.

Exterior

Clean the exterior surface with warm water and mild detergent. Rinse thoroughly and dry with a clean, soft cloth.

Door Gasket

The door gasket must be kept clean to ensure a proper seal. Make sure to clean the gasket frequently with the method as described above for exterior cleaning.

DEFROSTING

Frost build-up on the walls of the freezer section will increase energy consumption and reduce the efficiency of the appliance. Defrost the freezer section whenever the frost reaches a thickness of 1/4" (0.64 cm).

1. Remove food and ice cube tray from the refrigerator and freezer compartment.
2. If the model has a drip tray, be sure to place it under the freezer compartment to collect water. It may be necessary to empty the drip tray during the defrosting process.

⚠ WARNING



Electrical Shock Hazard

**Disconnect power before cleaning.
Replace all parts and panels before operating.
Failure to do so can result in death or electrical shock.**

3. Turn the unit off and unplug it from the outlet.
4. The defrosting process can take several hours. Open the door to speed up the process.
5. When defrosting is completed, wipe the compartment with a soft cloth to remove any remaining water.
6. Reset the refrigerator temperature, following the operating instructions on page 4.

IMPORTANT: Do not use sharp or pointed objects to remove frost or ice from the surfaces of the freezer compartment. This can cause damage to the compartment walls and cooling coils, and will void the warranty.

POWER FAILURE

When a power failure occurs, the refrigerator can normally keep food cool for several hours. Do not put additional food into the appliance during a power failure, and avoid opening the door. Disconnect the plug from the outlet, and reconnect when the power has been restored. Always inspect for, and discard any spoiled or thawed food in the refrigerator or freezer before resuming use of the appliance.

VACATION

Before leaving on any vacation, remove food that could spoil while you are gone. If you plan to be gone for an extended period of time, it's recommended that all of the food should be removed from the appliance and it should be turned off and unplugged from the outlet. Clean the interior according to the directions provided in the Cleaning section of this manual, and leave the door open.

MOVING THE REFRIGERATOR

⚠ WARNING

Excessive Weight Hazard
Use two or more people to move and install refrigerator.
Failure to do so can result in back or other injury.

1. Turn off the refrigerator and unplug from the outlet.
2. Remove all food and securely tape down all loose items inside.
3. Tape the door shut.
4. Do not lift or pull the door or door handle during transportation.
5. When moving, the appliance can not be tilted over 45 degrees as possible damage to the sealed system could occur.
6. Take care to avoid strong vibration or impact to the appliance.

REVERSING THE DOOR

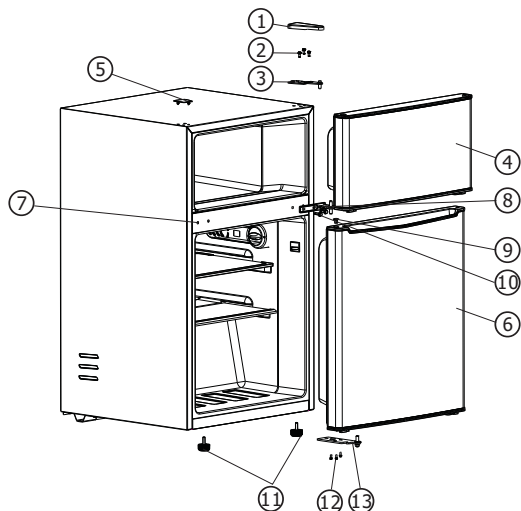

- ① Top hinge cover
- ② Top hinge screw
- ③ Top hinge
- ④ Freezer Door
- ⑤ Cabinet plugs
- ⑥ Refrigerator Door
- ⑦ Middle plug
- ⑧ Middle Hinge
- ⑨ Refrigerator Door Plug
- ⑩ Middle Hinge Screws
- ⑪ Leveling Legs
- ⑫ Bottom Hinge Screws
- ⑬ Bottom Hinge

NOTE: Do not tilt the appliance over 45 degree when reversing the door as possible damage to the sealed system may occur.

1. Remove top hinge cover and 3 top hinge screws which are below it. Then remove top hinge.
2. Remove Freezer Door
3. Remove 2 cabinet plugs and 1 door handle plug.
4. Remove middle hinge screws and middle hinge
5. Remove the refrigerator door.
6. Remove right and left leveling legs.
7. Remove 3 bottom hinge screws and the bottom hinge.
8. Install the bottom hinge on the other side of the leveling legs with 3 bottom hinge screws.
9. Install right and left leveling legs. There are two holes below the refrigerator to fit the two leveling legs.
10. Install the refrigerator door.
11. Install the middle hinge on the other side.
12. Install freezer door and fix the top hinge with 3 top hinge screws and fix the top hinge cover.
13. Adjust the leveling legs.

REPLACEMENT OF INTERIOR LIGHT

Uninstall the cover and replace the light with a screwing light (120V/10W). Refer to the illustrations and instructions below:

1. Move the lamp cover 1.2 - 2 (3.05 - 5.08 cm) according to arrow point direction.

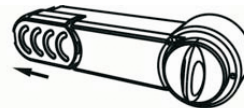

2. Take out the lamp cover.

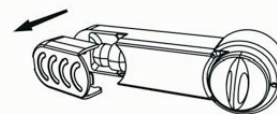

3. Rotate and take out the bulb in counterclockwise direction.

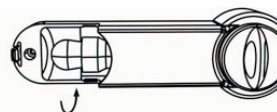

4. Replace bulb and reinstall lamp cover.

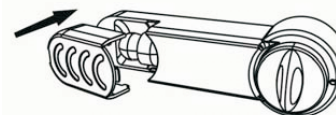

TROUBLESHOOTING TIPS

⚠ WARNING



Electrical Shock Hazard
Plug into a grounded 3 prong outlet.
Do not remove ground prong.
Do not use an adapter.
Do not use an extension cord.
Failure to follow these instructions can result in death, fire, or electrical shock.

Problem	Possible Cause	What to do
Refrigerator does not operate	•Not plugged in tightly	•Unplug, wait 10 seconds, then plug in again
	•Tripped circuit breaker or blown fuse	•Replace fuse or reset circuit breaker
	•Problem with electrical outlet	•Consult with a qualified electrician
Refrigerator seems too warm/food does not seem to cool	•Temperature setting may be too warm	•Lower the temperature setting
	•Door opened too frequently	•This is normal
	•Door not closed tightly	•Check to make sure that nothing inside the Refrigerator is causing the door to not close
	•Warm weather	•This is normal

Problem	Possible Cause	What to do
Compressor runs too long, or cycles on and off frequently	•Hot weather	•This is normal
	•Door opened too frequently	•This is normal
	•Door not closed tightly	•Make sure that nothing inside the refrigerator is causing the door to not close
	•Temperature control set at coldest setting	•Adjust temperature to a warmer setting
	•Large amounts of food placed in refrigerator	•This is normal
Moisture forms on the outside of the appliance	•This is normal during periods of high humidity	•Wipe the surface dry using a soft cloth
	•The door is slightly open	•Close the door tightly
Moisture forms on the inside of the appliance	•This is normal during periods of high humidity	•This is normal
	•Door is opened too long or too frequently	•This is normal
Vibration noise	•Refrigerator is on an uneven surface	•Adjust the leveling legs
	•Refrigerator is touching the wall	•Move the refrigerator away from the wall

The following are normal conditions that can be encountered during the operation of this appliance:

- The flow of refrigerant through the coils can cause a noise.
- The sides of the appliance may become warm as a result of the cooling function.

Assistance

Before calling for assistance or service, please check "Troubleshooting". It may save you the cost of a service call. If you still need help, follow the instructions below. When calling, please know the purchase date and the complete model and serial number of your appliance. This information will help us to better respond to your request.

For parts replacement

If you need to order replacement parts, we recommend that you only use factory specified replacement parts. Factory specified replacement parts will fit and work correctly because they are made with the same precision used to build every new refrigerator.

To locate factory specified replacement parts in the area, call us or the nearest designated service center.

In the U.S.A.

toll free: 1-855-666-4477.

Limited Warranty

This warranty applies to products purchased and used in the U.S. This is the only express warranty for this product and is in lieu of any other warranty.

This product is warranted to be free from defects in material and workmanship for a period of one (1) year from the date of original purchase, except as noted below. During this period, we will repair or replace this product at our option.

This warranty extends only to the original consumer purchaser and does not cover a defect resulting from abuse, misuse, neglect including failure to clean product regularly in accordance with manufacturer's instructions, use for commercial purposes, or any use not in conformity with the printed directions.

This warranty is provided by Galanz-Zhongshan Galanz Consumer Electric Appliances Co.,Ltd.

We exclude all claims for special, incidental, and consequential damages caused by breach of express or implied warranty. All liability is limited to the amount of the purchase price. **Every implied warranty, including any statutory warranty of merchantability or fitness for a particular purpose, is disclaimed except to the extent prohibited by law, in which case such warranty is limited to the duration of this written warranty.** This warranty gives you specific legal rights. You may have other legal rights that vary depending on where you live. Some states do not allow limitations on implied warranties or special, incidental, or consequential damages, so the foregoing limitations may not apply to you.

If you have a claim under this warranty, please call our CUSTOMER SERVICE NUMBER: 1-855-666-4477. For faster service please have model number and serial number ready for operator to assist you.