

# GREEN CARBON WATER CONDITIONER

CHLORINE & CHLORAMINES REMOVAL SYSTEM

## INSTALLATION INSTRUCTION & OWNER'S MANUAL Ver 2.0



**APEC WATER**

 [www.FreeDrinkingWater.com](http://www.FreeDrinkingWater.com)

All Rights Reserved © APEC Water Systems

**Please keep this Owner's Manual for future reference.**

It contains helpful information on how to maintain and care for your APEC Green Carbon Water Conditioner.

*Thank you for choosing APEC Green Carbon Premium Water System.*

Please read and become familiar with instructions and parts needed before proceeding with the installation.

Copyright:

This manual is copyrighted by APEC Inc. Under the copyright laws, this manual may not be reproduced in any form, in whole or part, without the prior written consent of APEC Inc. Manual print ver 2.0, 2018 Jun.

# Parts List for Green Carbon Conditioning System Installation Kit (2 packages):

## Package #1: Media tank and filter system installation kit.



Bypass Valve  
**X 1**

### V3007-02LF kit includes:



Brass Sweat Adapter Kit  
**X 2**



1" Quick Connect  
**X 2**



Plastic Split Rings  
**X 2**



Rubber O-rings  
**X 2**

### V3007 kit includes:



Elbow Solvent Kit  
**X 2**



1" Quick Connect  
**X 2**



Plastic Split Rings  
**X 2**



Rubber O-rings  
**X 2**

## Green Carbon Sytem Media Flush kit:



1 each 1" Dura Coupling  
FPT PVC Adapter (D2466)



1 each 1" MPT x 3/4" FPT  
PVC Dura Bushing (D2464)



1 each 3/4" FHT x 3/4" MPT x 1/2" FPTB  
Garden Hose Brass Adapter (A-679)

## Media tank:



Tank with In/Out Valve  
**X 1**

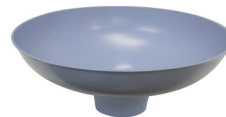

Funnel  
**X 1**

## Package #2: Water treatment system media.

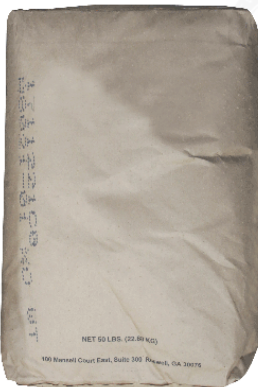

Water Treatment Media

The media weight varies from 27.5 lbs. to 55 lbs., depending on the system model.

## Product Operation and Specifications

### Rated Service Flow (GPM):

- GreenCarbon- 10 8-10 GPM
- GreenCarbon- 15 10-15 GPM

### Rated Capacity (Gallons):

- Holds 9.1 Gallons in the GreenCarbon- 10 Tank
- Holds 16.7 Gallons in the GreenCarbon-15 Tank

### Minimum Working Pressure (PSIG): 25 PSI

### Operating Temperatures: 36-120 Degrees Fahrenheit

### pH Range: 7-11 pH

**Plumbers Notice:** If this of any other system is installed in a metal (conductive) plumbing system, i.e. copper or galvanized metal, the plastic components of the system will interrupt the continuity of the plumbing system. As a result any errant electricity from improperly grounded appliances downstream or potential galvanic activity in the plumbing system can no longer ground through contiguous metal plumbing.

Older homes may have been built in accordance with building codes from decades ago some of which actually encouraged the grounding of electrical appliances through the plumbing system. Consequently, we highly recommend either the installation of a by-pass consisting of the same material as the existing plumbing, or a grounded "jumper wire" bridging the equipment and reestablishing the contiguous conductive nature of the plumbing system. Please ensure that your installation of the system comply with applicable state and local regulations.

**Well Water Locations:** Installation of this system will be after any and all well equipment, i.e. Well pump, Bladder tank, Pressure tank, etc.

## Preparing tank for installation instructions. Please follow installation steps below:

### **Safety Instructions IMPORTANT!**

- Wear proper eye protection (ex. tightly fitting safety goggles), face mask, hand gloves, protective clothing, etc when installing water treatment media into tank for installation.
- Wash your hands and face after installation.
- Please Keep out of reach of children.

Step 1. Unscrew in/out valve from the top of the tank. (See Figure. 1) (Counterclockwise)

Step 2. Place the funnel on the top of tank, and pour all of the media into the tank. (See Figure. 2)

Step 3. Once all of the media is installed, please remove the funnel and tube cover.  
**Very important (See Figure. 3)**

Step 4. Obtain the in/out valve and verify the o-ring is properly in place. (See Figure. 4A)

Step 5. Screw the in/out valve tightly onto the top of the tank. (See Figure. 4B) (Clockwise)



Figure. 1



Figure. 2

**Your tank media is properly installed. Great job! Please continue with system installation on next page.**



Figure. 3



Figure. 4A



Figure. 4B

## System Installation:

This is an overview for the system installation.

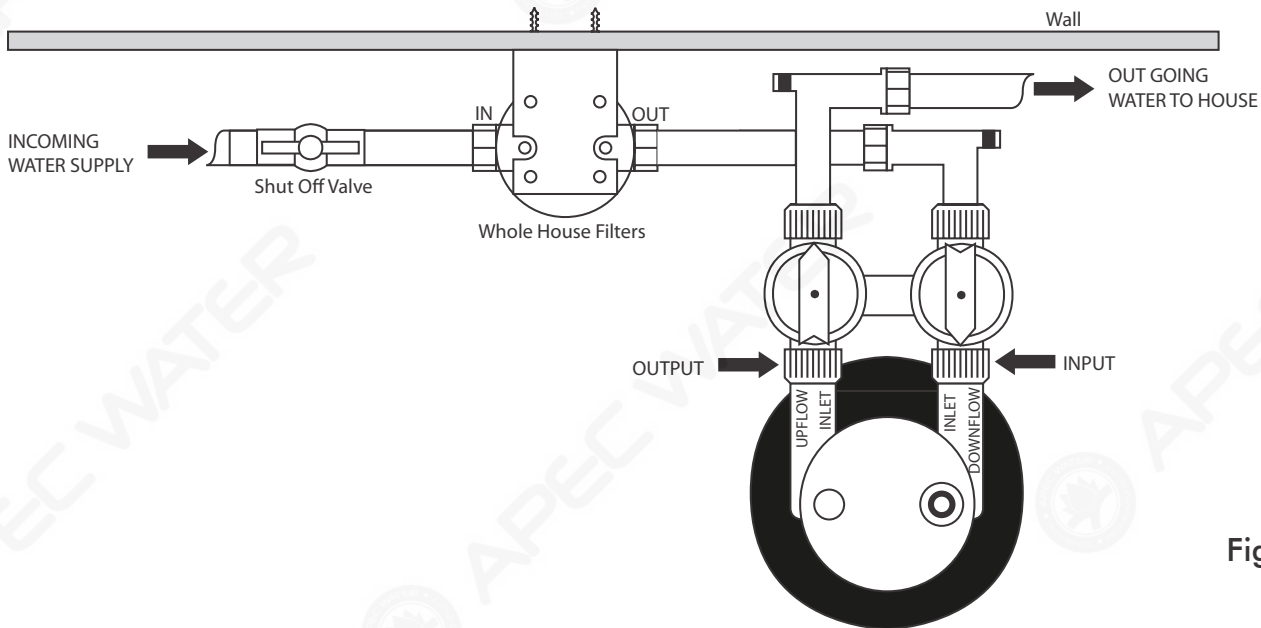

Figure. 1

1. Turn off water supply where it enters the building.
2. Install a shut off valve (if needed) then install the Whole House Sediment Filter in the vertical position. Make sure the flow direction is correct. Plumbing pipes are not designed to support the weight of the filter. Use a mounting bracket to secure the Whole House Sediment Filter to the wall. Be sure to remove the plastic wrap on the filter before installing the filter. (See installation guide for Whole House Water Filter for more detailed information).

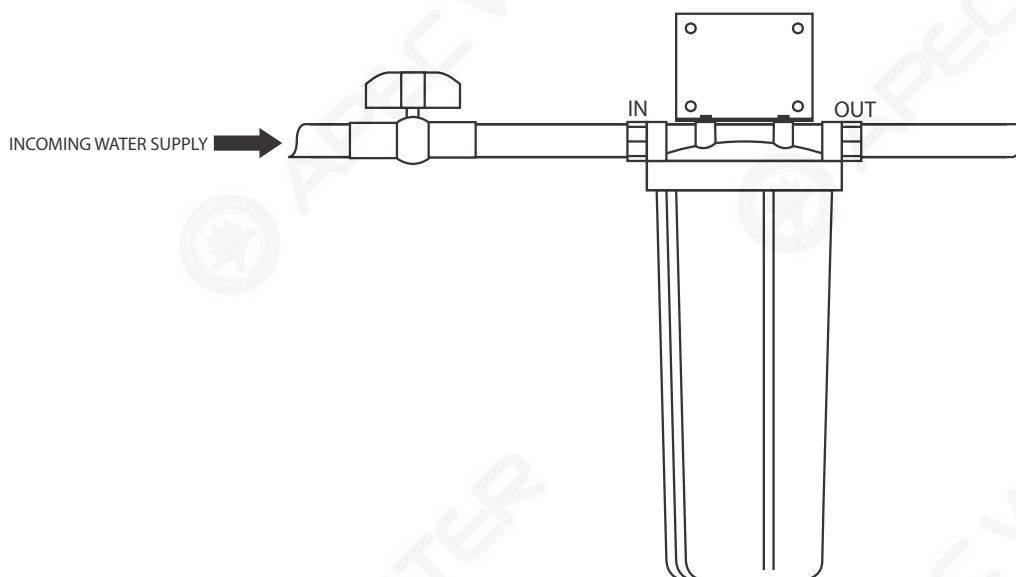



Figure. 2

## Flushing the Carbon in the Carbon Tank:

Use provided parts V3007, D2466, D2464, A-679.

Once the media tank is installed on the main water pipe, you must **Flush Out** the Carbon media for 10-15 minutes or until the water runs clear. To flush the media turn the Bypass Valve to Normal Operation Mode. (See figure. 3). Once the bypass valve is open, find the outside garden hose faucets that are located nearest the Green Carbon Tank and open the faucets all the way to flush the system.

**Note:** Some homes may have a separate line for the home and garden. If this is the case, attach a garden hose to the **UP-Flow Side** of the control head. (See Figure. 3). Turn the Bypass Valve to Normal Operation Mode, and let the water run out of the garden hose for 10-15 minutes or until the water runs clear. Once the carbon flush is complete, attach the **UP-Flow Inlet** to the main water line going into the home.

 **Caution:** Failure to completely flush the media prior to use may result in carbon blocking the top basket and reducing water flow in the home. It may also fill up your kitchen sink, bathtub with black carbon fines.

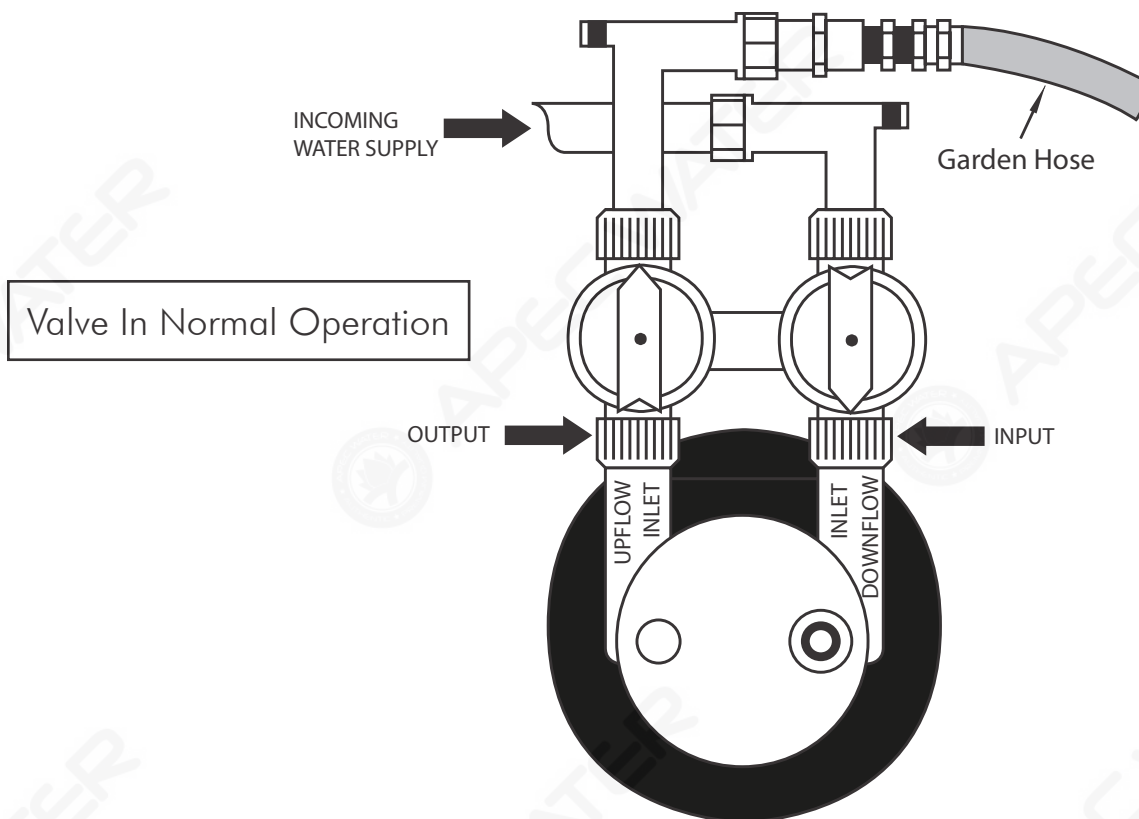

Figure. 3



## Carbon Tank Installation

1. The bypass valve comes complete with O-rings, split rings and black quick connector nuts. Install the bypass valve by pressing the valve onto the head of the tank and hand tighten both black quick connect nuts.
2. When running the piping for the Green Carbon Water Conditioner, connect the incoming water supply to the **DOWN-FLOW INLET (Input)** side. Connect the water supply line going into the house to the **UP-FLOW INLET (Output)** side. (See Figure. 4)

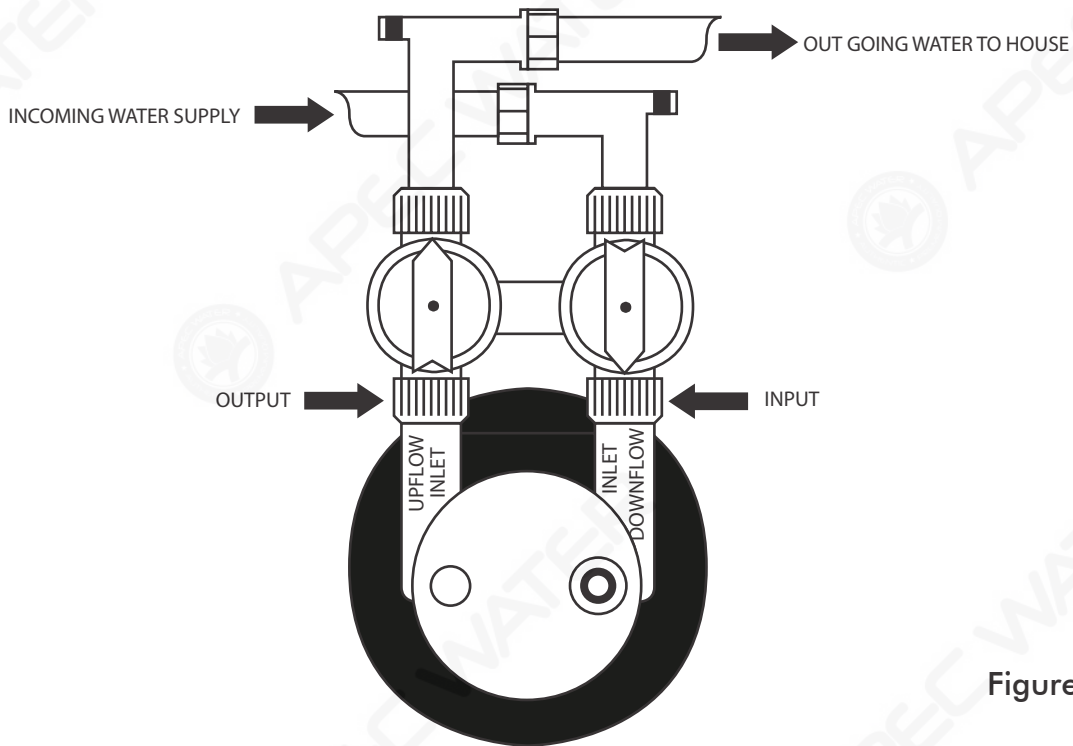

Figure. 4

3. Use the appropriate fitting connection to the bypass valve. Brass Sweat Adapter Kit (V3007-02 ) for copper piping. (Follow the instructions supplied with the fittings for assemble).
  - a. **Important:** If soldering connections are used, do not install the O-rings, split rings and black quick connect fittings and piping. Allow solvent cements to set before installing the black quick connector nut, split ring and O-rings.
  - b. **Important:** If PVC solvent connections are used, use solvent cements and primers to connect fittings and piping. Allow solvent cements to set before installing the black quick connector nut, split ring and O-rings.

## Bypass Valve Operation Mode

**Normal Operation Mode:** Water flows through the Bypass Valve and into the Green Carbon Conditioner supplying treated water into the house. (See Figure 5)

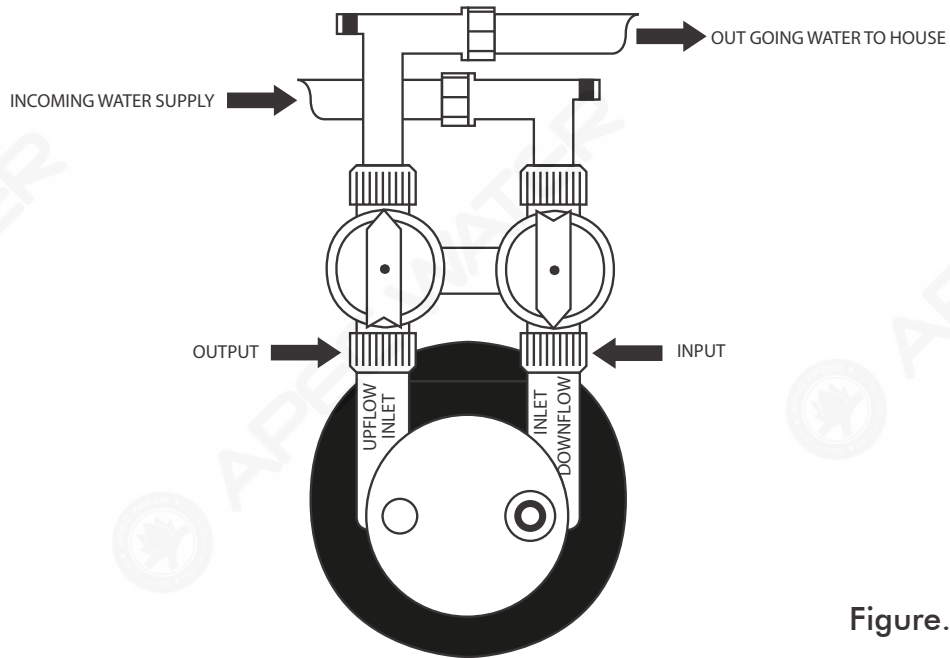

Figure. 5

**Bypass Operation Mode:** Water flows through the Bypass Valve without entering the Green Carbon Conditioner and the water entering the house is untreated. (See Figure 6)

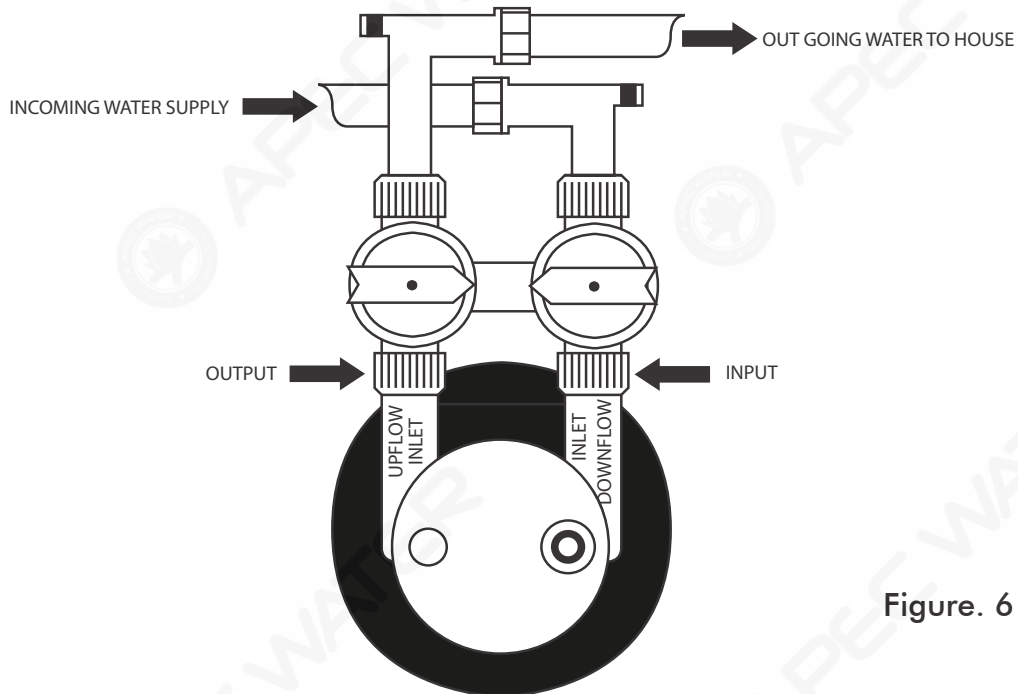

Figure. 6

## Carbon Conditioner Overview

1. During the carbon flush, the pressure can start to drop off. If this happen, turn off the water and let the tank sit about 30 minutes to allow the carbon to settle down off of the basket inside the tank. Pressure drop can occur as there is air trapped in the carbon bed that needs to be released from the tank. If the pressure continues to drop after 30 minutes, let the system stand for 72 hours. After 72 hours, slowly turn the water supply back on and continue the carbon wash.
2. Even after the carbon flush, you may notice that the water to your home may be gray. This is normal with all carbon filters and this will slowly fade away. The carbon inside the tank may still have air pockets, and can turn the water gray with carbon dust. The carbon dust is completely harmless.
3. The pleated sediment pre filter provided can be rinsed out and reused. Depending on the amount of sediment present in your water supply, it is recommend to check the pre filter every 6-12 months. If you notice a pressure loss, the sediment filter can be clogged and needs to be rinsed out. After 1-2 rinses of the sediment filter it is recommend to replace the entire sediment pre filter.
4. After the installation of the Green Carbon Conditioner, **CHECK FOR LEAKS**. If you notice water leaking at the control head, turn the head to tighten it up. The tank head is hand tighten, do not over tighten the head. Do not over tighten any of the fitting during installation. All fittings should be hand tightened with the exception of the pre-filter housing.
5. The bottom of the tank is round, and uses the tank stand to stand the tank upright. If the tank leans to one side simply raise the tank in the air and set it on the ground until the tank stands vertical. You should do this before filling the tank with water, as the tank will be heavy when filled with water.
6. After installation the arrows on the bypass valve may be pointing in different directions than shown in our diagrams. If this is the case simply pull up on the Red Arrows and turn them around.
7. Once the installation is complete, remove the protective film around the Stainless Steel tank jacket.

**\*\*\*\* END OF INSTALLATION MANUAL \*\*\*\***

## WARRANTY POLICY

For a period of ten years from the date of original purchase, APEC will replace any part of the filter housing, tank heads, and the bypass valves that APEC finds to be defective in operation due to faulty materials or workmanship with the exception of the replaceable media, which shall be prorated. The customer pays only for shipping. Service schedule depends on local input water quality.

Damage to any part of this Green Carbon Water Conditioner because of misuse, misapplication, negligence, alteration, accident, installation or operation contrary to our instructions, incompatibility with accessories not installed by APEC, or damage caused by freezing, flood, fire, or Act of God, is not covered by this warranty. In all such cases, regular charges will apply. This warranty is void if the unit is not operated under normal operating conditions as the unit is intended for.

We assume no warranty liability in connection with this carbon conditioner other than specified herein. This warranty is in lieu of all other warranties, expressed or implied, including warranties of fitness for a particular purpose. We do not authorize any person or representative to assume for us any other obligations on the sale of this water softener.

This warranty becomes effective when the system is installed correctly and used properly. This carbon conditioner unit has been inspected and approved at our factory. Through this warranty we are demonstrating our confidence in APEC products.



**Advanced Purification Engineering Corp.**

1320 S Johnson Drive  
City of Industry, CA 91745

*For questions or comments please visit our website at:*

**[www.FreeDrinkingWater.com](http://www.FreeDrinkingWater.com)**

*For technical support contact us at:*

**Techsupport@freedrinkingwater.com**  
**1-800-880-4808**