

Features

- Left centered drain.
- Removable drain cover.
- Three tile-in flanges.
- Complements traditional and contemporary bathroom designs.
- 60" (1524 mm) x 34" (864 mm) x 4" (102 mm)

Material

- Cast iron with Safeguard® finish.

Installation

- Alcove installation.

Required Accessories

K-9157 Drain Cover

or

K-9159 Drain Cover



Codes/Standards







ASME A112.19.1/CSA B45.2

KOHLER® Lifetime Limited Warranty for Cast Iron Components

See website for detailed warranty information.

Available Color/Finishes

Color tiles intended for reference only.

Color	Code	Description
	0	White
	96	Biscuit
	47	Almond
	NY	Dune
	95	Ice™ Grey
	G9	Sandbar

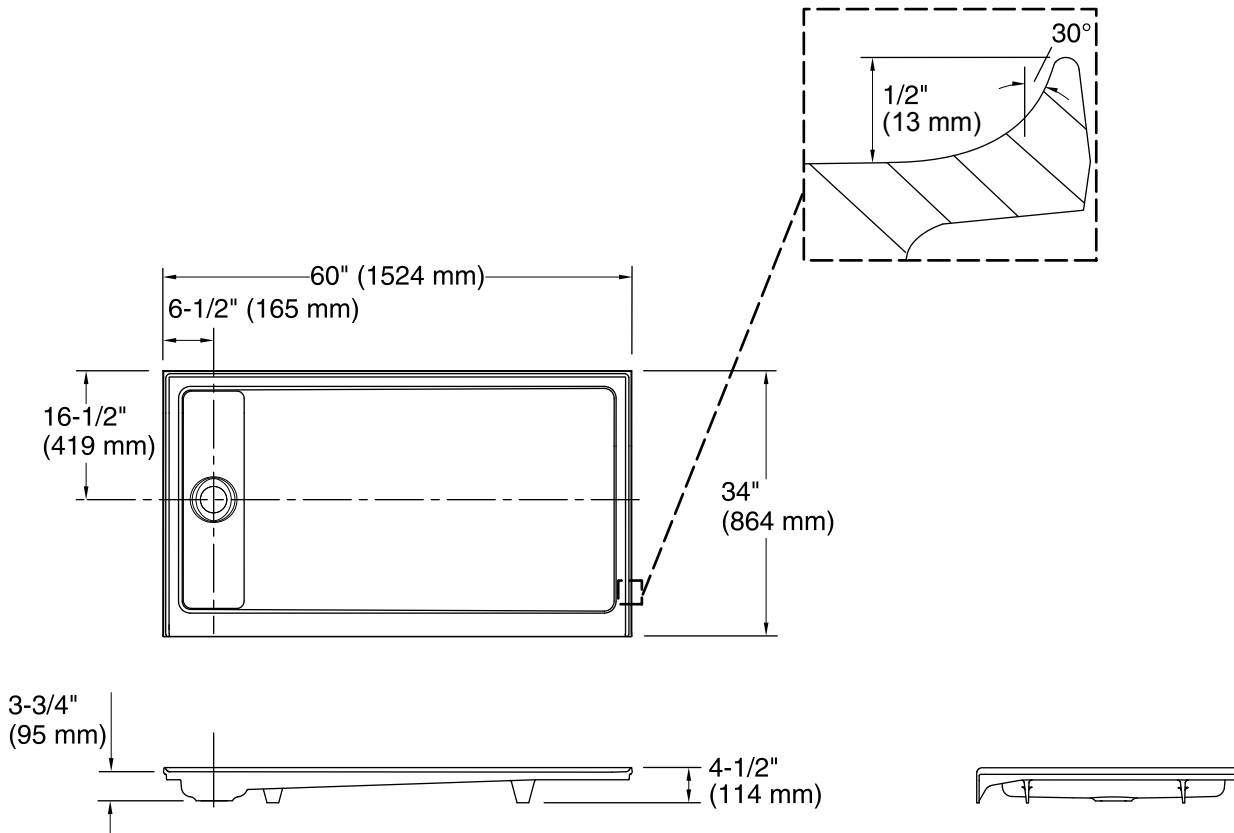

Technical Information

All product dimensions are nominal.

Installation: 3-Wall Alcove

Drain location: Left

Weight: 193 lbs (87.5 kg)

Notes

Install this product according to the installation guide.

The dimensions are applicable for this product only and should not be used to fabricate substitute bases for shower enclosures.

The K-1657/K-1663 or K-1708/K-1647-PC steam generator/control kit are designed for use with this product. Kohler Co. shall not be responsible for problems encountered due to the installation and use of other manufacturer's steam generators.