

Limited Warranty Statements

1. Warranty

LockeyUSA "LDS" warrants the Product to be free from defects in material and workmanship for a period of 12-months from the original date of purchase.

If you discover a defect in the Product covered by the warranty, we will repair or replace the item using new or refurbished components.

2. Exclusions

The warranty covers defects in manufacturing and/or workmanship discovered while using Product as recommended by LDS rather than those caused by acts of God, misuse, abuse, installation errors or unauthorized modifications.

3. Limited Liability

LDS will not be held liable for incidental or consequential losses or damages caused by any act of God, misuse, abuse or unauthorized modification of Product.

4. Reminder

Service requirement shall be subject to the presentation of this warranty card and defective parts to the manufacturer, LDS. The warranty card will not be reissued if lost.

Product: E-DIGITAL ELECTRONIC KNOB & LEVER LOCK

Purchase Date: _____

Name & Address of Distributor: _____

Send warranty forms to:
 LockeyUSA Warranty Department
 PO Box 543 | Mt. Pleasant, Michigan | 48858
 www.lockeyusa.com



E-DIGITAL ELECTRONIC LOCK SERIES

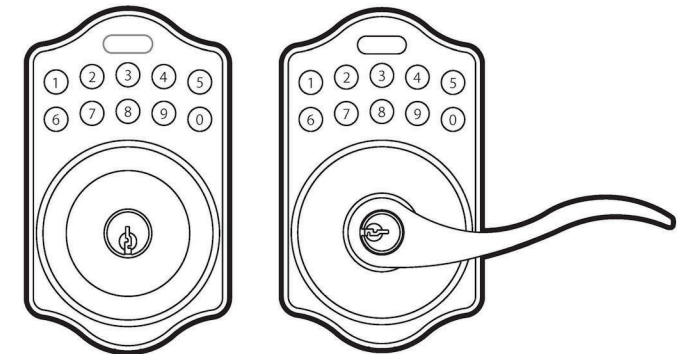

USER MANUAL



Attention : Do not use power tools

E-DIGITAL ELECTRONIC KNOB & LEVER INSTALLATION INSTRUCTION

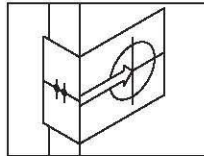

The BACKSET is the distance between the center of cross bore and edge bore of the door. Adjustable latch fits both BACKSET of 2-3/8" (60mm) and 2-3/4" (70mm). Please follow the steps shown below for BACKSET adjustment.

- The backset shown on the left is 60mm (2-3/8").
- Pull the cam toward right to extend the backset to 70mm (2-3/4").
- The backset shown in figure C is 70mm (2-3/4"). Pulling the cam back to left will return the backset to 60mm (2-3/8").

Note : The shape of cam should be square.

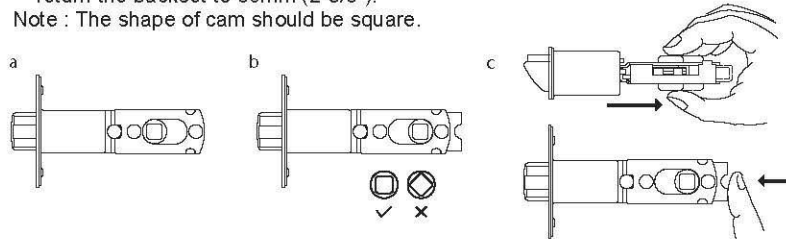

Please Note: If you have a pre-drilled bore or are replacing an existing lock, remove all existing hardware and strike, and skip to Step 3.

1. Mark The Door With Template

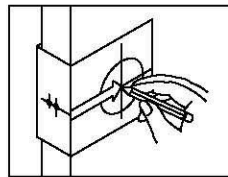

Select the height and backset as desired on the door face ; use the TEMPLATE as an indication to mark the center of the circle on the door face and the center of the door edge.

2. Drill Holes

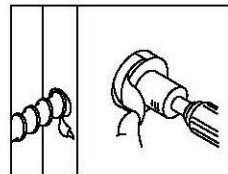

Using the marks as a guide to drill a hole $\varnothing 2-1/8"$ (54mm) through the door face for the lockset, then a hole of $\varnothing 1"$ (25.4mm) for latch.

1

3. Identify Door Handing

Face the door from outside, the door is left handed if the hinge is on the left-hand side of the door, whereas the door is right handed if the hinge is on the right-hand side of the door.

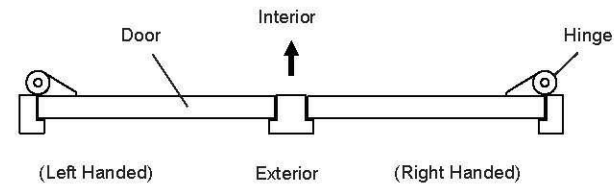

4. Install Latch

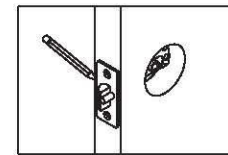

- Insert the latch and lay the faceplate against the door edge. Use a pencil to mark it's perimeter, then take out the latch.

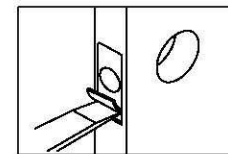

- Chisel out the portion you've marked with pencil to about 4mm (5/32") deep. Score the area within the borders as clearly and precisely as possible. Ensure the plate can fit flush with the door edge surface.

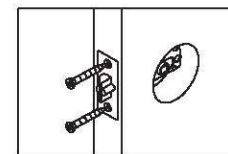

- Insert the latch and tighten it with screws. Be sure the holes for thru-bolts (next to the adjustable cam) are horizontally aligned.

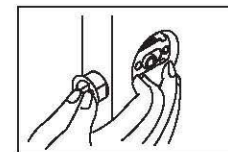

- It is not necessary to chisel the door edge for the faceplate installation if you use a drive-in latch. (not incld) You may install it into the edge bore directly, making sure the bevel faces the outside assembly.

2

5. Install Strike

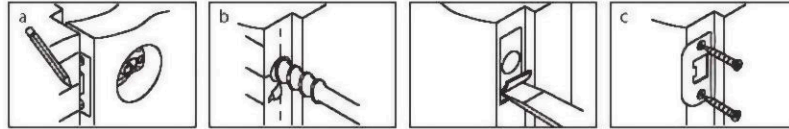

- Half-close the door to lay the latchbolt against the door frame. Mark the position of faceplate as an indication. Place the strike against the door frame and mark its perimeter. Be sure the center of strike is perfectly aligned with the center of faceplate.
- Drill a $\varnothing 25.4\text{mm}$ (1") hole with 13mm (1/2") depth on the center of strike outline. Then use the chisel to scrape out the door frame for 1.6mm (1/16") deep within your pencil mark. Ensure to chisel deep enough to allow the strike to lay flush with the frame surface.
- Insert the strike and tighten it with screws.
Note : please use "tapping screws" for metal door.

6. Install Keypad Assembly

- Place the leverset/knobset against keypad with tailpiece in vertical position inserted through cam of the latch.

PLEASE NOTE: Tailpiece MUST be in VERTICAL position.

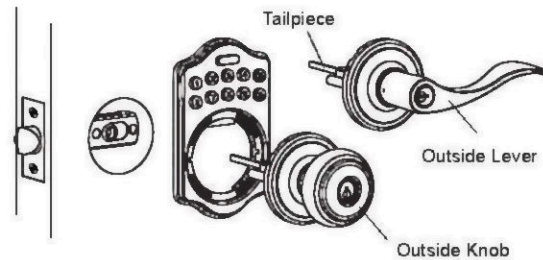
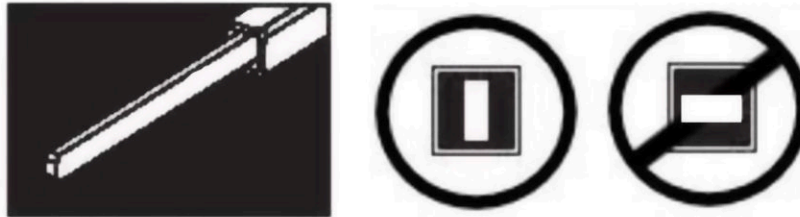

3

- Pass the IC wire over the latch to the interior side of door. Do **NOT** pinch wire.

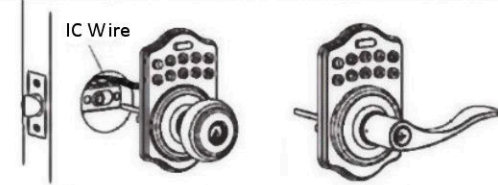

7. Install Inside Mounting Plate

Pass the IC wire through the wire hole on the mounting plate and fix the mounting plate with screws. If outside lock assembly is lopsided, please loosen the screws to adjust its position and tighten the screws again.

*****Please Note: Do NOT pinch IC wire*****

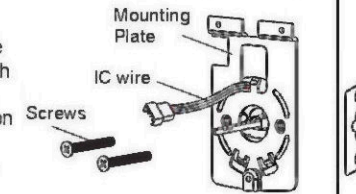

8. Install Receiver Module

- Remove the battery cover (push it up and pull it out).
- Connect the IC wire and ensure the turn piece is horizontal, so that the tailpiece is able to engaged with the inside lever/knob. Then attach receiver module to the door with screws. It's optional to use the attached wood screw.
(Wood screw only for wood door)

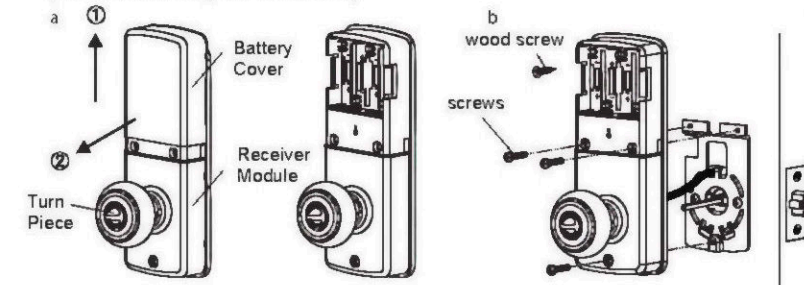

- Insert 4 (AA) 1.5V alkaline batteries and put the battery cover back to the receiver module.

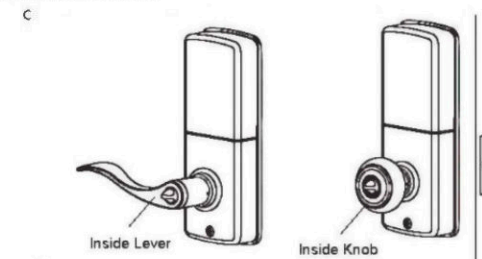

4

9. Change Lever Handing

- a. Be sure the levers are unlocked.
Insert the provided pin wrench into the small hole on the neck of lever and apply pressure to depress the catch and pull out the lever from the stem.
Follow the same steps to remove interior lever and exchange the position of inside and outside levers.

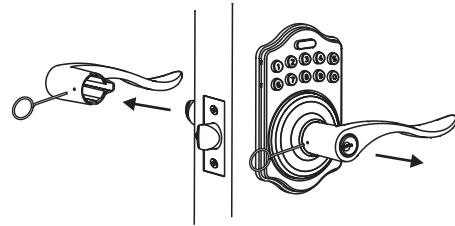

- b. Remove the cylinder from lever and insert it into opposite lever.
Then install the levers and make sure the small hole on the neck of lever aligns over the catch perfectly. Rotate the levers to see if it operates well.

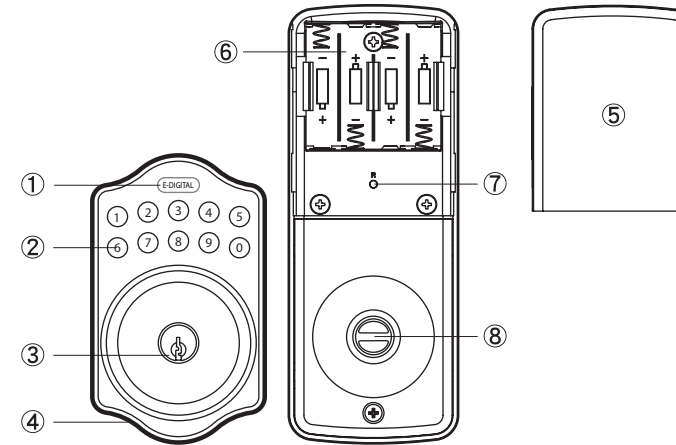
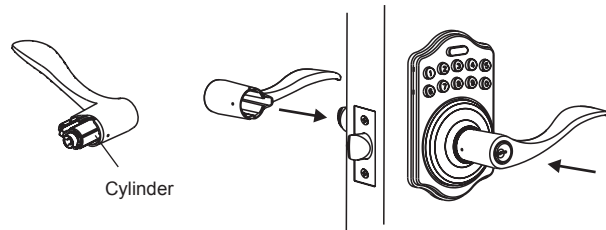

- ① **Programming Button**
Programming Button is for entering codes, clearing errors and setting function.
It's also a lock button.
- ② **Number Buttons**
Input the user codes, each user code is 4-10 digits in length.
- ③ **Cylinder**
Lock/Unlock the lockset from exterior.
- ④ **Gasket**
Prevent water permeating into lockset.
- ⑤ **Battery Lid**
Slide the lid to change the batteries.
- ⑥ **Battery Holder**
Four AA (1.5V) Alkaline batteries.
- ⑦ **R Button (Reset)**
Restore default setting.
- ⑧ **Turn-Button**
Lock/Unlock the lockset from interior.

Specification/Function

1. Power

6V - Requires four AA (1.5V) Alkaline batteries.

2. Low Battery

2-1 The batteries should be changed immediately when you see button 1 flashing in red and hear 10 rapid beep sounds when pressing programming button.

2-2 All settings are retained in the memory and will not be effected even if the battery is completely dead.

2-3 The lock can still be operated by key if the lock is without power.

3. Illuminated Indicator

3-1 Button 1 flashes green once for successful operation.

3-2 Button 1 flashes in green twice for successful programming.

3-3 Button 1 flashes in red 3-times when there is an operation error.

3-4 Button 1 flashes in red 5-times for code input errors. the system will shut down for system protection after 5 incorrect entries (Refer to #16).

3-5 Button 1 flashes in orange 3-times when system has been restored to default setting.

3-6 Button 1 flashes in orange slowly while in programming mode.

4. Audible Indicator

4-1 1 beep sound indicates a successful operation.

4-2 2 long beep sounds indicate successful programming.

4-3 3 beep sounds indicate an operation error.

4-4 3 long beep sounds indicate that the system has been restored to default settings.

4-5 5 beep sounds indicate code input error. System will shut down after 5 incorrect entries. (Refer to #16)

4-6 10 rapid beep sounds indicate that the batteries are low. Change batteries immediately.

5. Programming Code

5-1 The preset Programming Code is 0000. Please change Programming Code after first operation.

5-2 Programming Code is only for function setting. You cannot unlock the lockset by entering Programming Code.

5-3 Programming Code must be 4-10 digits.

5-4 If necessary, Programming Code can be changed at any time.

6. User Codes

6-1 The preset User Code is 1234. Please delete it and create a new User Code during first operation.

6-2 Up to 6 sets of User Codes can be saved at one time.

6-3 User Codes are only used to unlock the lockset.

6-4 User Codes must be 4-10 digits.

6-5 User Codes can be added or deleted at any time.

7. Deleting Individual User Codes

7-1 User Codes can be deleted individually. You can reset the same number code even if it has been deleted previously.

7-2 Programming Code is needed when deleting individual User Codes.

8. Deleting All User Codes At Once

8-1 All User Codes can be deleted at once. You can still reset and use the same User Codes even if you have deleted them previously.

8-2 Auto-locking and Keypad locking functions will be invalid after deleting all User Codes and the lock will only be operational with the key. These functions will be restored with the creation of new User Codes.

8-3 Programming Code is needed when deleting all User Codes.

9. Temporarily Disabling All User Codes

9-1 Auto-locking and Keypad locking function will be invalid when User Codes are temporarily disabled. The lock can only be operated by key during this time.

9-2 Repeat the programming steps to restore the auto-locking and keypad locking functions once User Codes are restored.

10. Creating Disposable User Codes

10-1 Disposable User Codes are invalid after one use.

10-2 You can reset the same numbers as User Codes.

10-3 Programming Code is needed when creating Disposable User Codes.

11. Restoring Preset Factory Codes

11-1 You can restore the Preset Factory Code by pressing the "R" button on the interior of the receiver module. Used when you forget your Programming Code or you want to cancel all previously created settings.

11-2 After system restore, the Programming Code will be "0000" and the User Code will be "1234".

12. Unlocking the Lockset

The lockset can be unlocked by key, by entering the User Code and E-Digital button on the keypad or with the turnpiece on the interior of the door.

13. Locking the Lockset

The lockset can be locked by key, by pressing the Programming Button "E-Digital" on the keypad or with the turnpiece on the interior of the door.

14. Activating/Deactivating the Auto-Locking Function

- 14-1 The lockset will automatically lock itself within 10-99 seconds when this function is programmed.
- 14-2 The function is not preset and must be programmed to operate.
- 14-3 The preset delay-time is 30-seconds. The delay-time can be adjusted as needed.
- 14-4 The same programming steps are used to both activate and deactivate the auto-locking function.

15. Turn Mute On/Off

- 15-1 Beep sounds will be heard when pressing keypad, and for programming and operating errors.
- 15-2 LED Illumination will still function while in Mute. The warning alarm will not function while muted, and it is recommended not to Mute device unless necessary.
- 15-3 The normal operating sounds of the motor cannot be muted.

16. Code Protection Function

The system will shut down when incorrect codes are entered more than 5-times. The system will be restored after 45-seconds of inactivity.

17. Illumination

The LED Keypad will light up when pressing any button to ensure ease of operation in the dark.

User Code & Function Setup

1. The lockset **must** be in the unlocked position while programming.
2. Change default Programming Code "0000" and User Code "1234" before function setup.
3. LED flashes orange slowly while programming. LED flashes green twice with two long beeps when input is correct. LED flashes red three times with three beeps when incorrect. You will need to wait 6-seconds or press programming button when incorrect input is entered. After 6-seconds system operations will be restored.
4. Each programming step should be completed within 6-seconds.
5. You can lock/unlock the product with both the key and the keypad. Please refer to the programming table on the following page for function setup instructions.

IMPORTANT

1. The use of alkaline batteries is recommended to stabilize the power supply.
2. Do **not** mix battery brands or mix alkaline batteries with regular zinc-oxide batteries.
3. Do **not** use any chemical liquid or lubricating oil with additives to clean the lock body. Use of these products could damage the product's surface and/or mainboard.
4. If there is any problem with the product, please contact LockeyUSA "LDS".

Function Programming

Programming Code (PC)

NOTE: LOCK MUST BE IN UNLOCKED POSITION TO PROGRAM

USER Code (UC)

Add New User Codes (Refer to #6)



Remark :

Up to 6 sets of User Codes can be saved. User Code should be 4-10 digits in length.

Delete Existing User Codes (Refer to #7)



Delete All User Codes (Refer to #8)



Remark : Auto-locking and Keypad locking function will be disabled when User Codes are deleted. The lock can only be operated by the key during this time.

Change Programming Code (Refer to #5)



Turn Autolock On/Off (Refer to #14)



Remark : The preset delay-time is 30 seconds, you can change the time by following the instructions below.

Repeat the steps to cancel the Auto-locking function.

Set Autolock Time Delay (Refer to #14)



Remark: 10-99 seconds delay-time available.

11

Programming Code (PC)

USER Code (UC)

Turn Mute On/Off (Refer to #15)



Remark : Repeat same steps to turn sound On/Off.

LED illumination is still functioning when it's in mute, but there will be no warning alarm.

Enable/Disable All User Codes (Refer to #9)



Remark : Auto-locking and Keypad locking function will not work when User Codes are disabled. The lock can only be operated with the key during this time. Repeat the steps to enable the User Codes again.

Create Disposable User Codes (Refer to #10)



Remark : Disposable user code is no longer valid once it's been used.

Restore All Preset Factory Settings (Refer to #11)

Press **(R)** on the interior of the receiver module.

Remark: Press and hold button for more than 5-seconds. The restoration will be complete after you hear 3 long beeps.

PLEASE NOTE: LOCK MUST BE IN UNLOCKED POSITION TO SUCCESSFULLY COMPLETE PROGRAMMING FUNCTIONS.

Visit www.LockeyUSA.com for additional product information.

12