

Stackable Individual Locker 24"

Please read and save these instructions. Read through this owner's manual carefully before using product. Protect yourself and others by observing all safety information, warnings, and cautions. Failure to comply with instructions could result in personal injury and/or damage to product or property. Please retain instructions for future reference.

Stackable Individual Locker 24"

REF. #	Parts Description & Qty	PART #
A	1 Frame and Door Assembly	MK037
B	1 Left Side Panel	CB672
C	1 Right Side Panel	CB706
D	1 Back Panel	HB385
E	1 Bottom Panel	CB108
F	1 Top Assembly	DB085
G	3 Hooks	GJ000101
H	2 Corner Protectors	FZJLK001
I	1 Number Plate assembly	TH00151
	1 Number Plate	
	2 M3*5 Screws	
	2 M3*2.5 Nuts	
J	24 M5*10 Screws	LS051003
K	24 M5*3 Nuts	LMKBC001
L	1 Outer Hexagon Wrench	BSKL0501

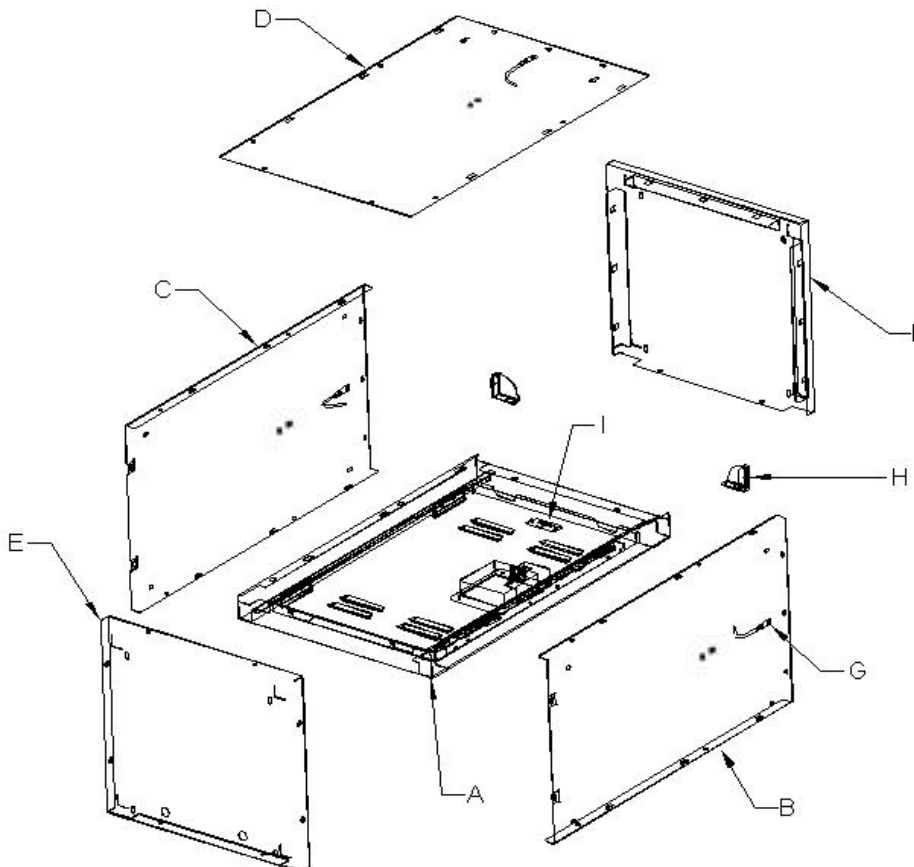
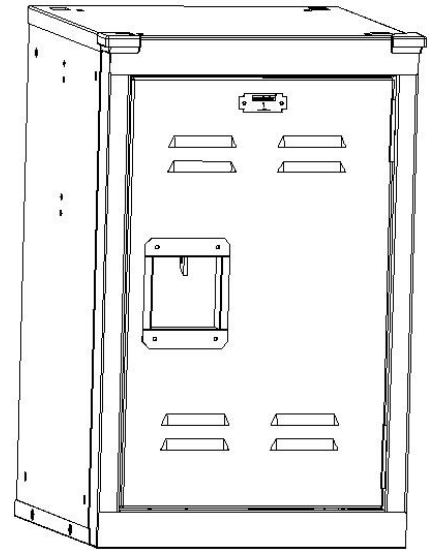

Stackable Individual Locker 24"

Installation

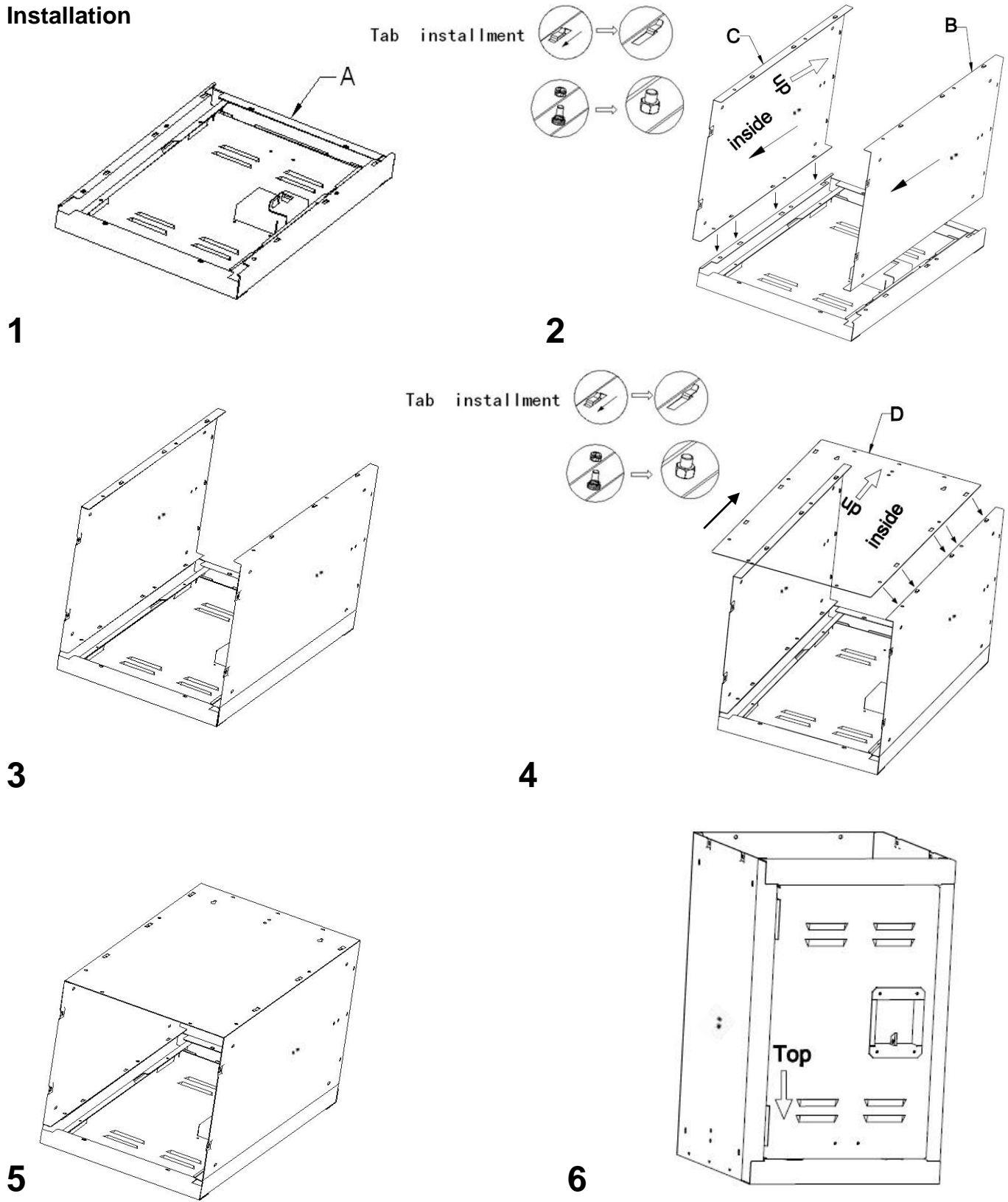

Stackable Individual Locker 24"

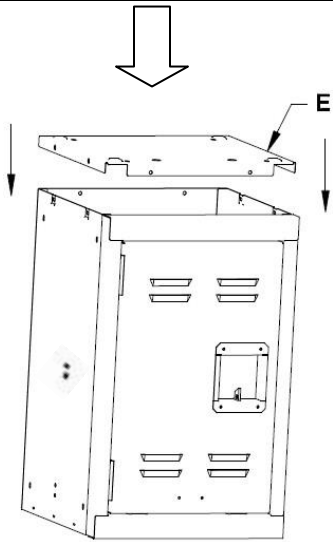

7

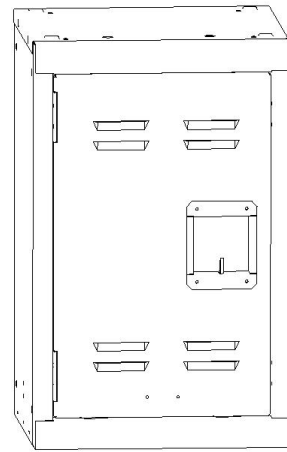

8

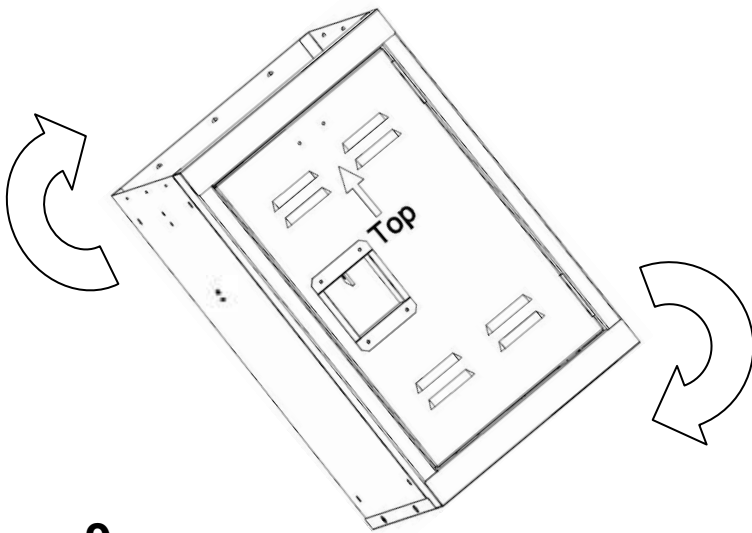

9

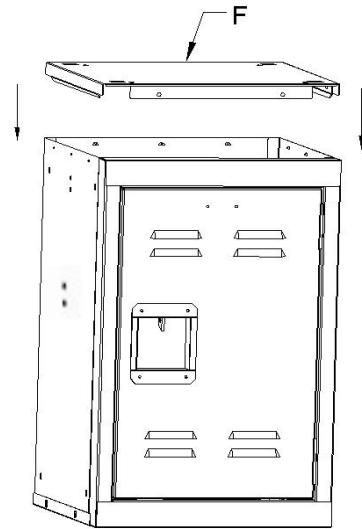

10

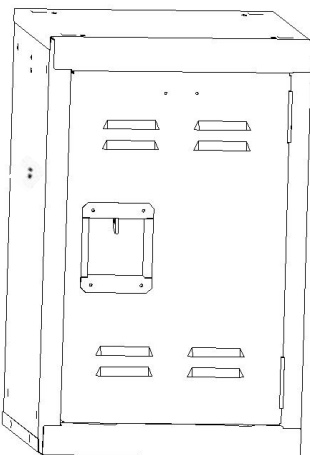

11

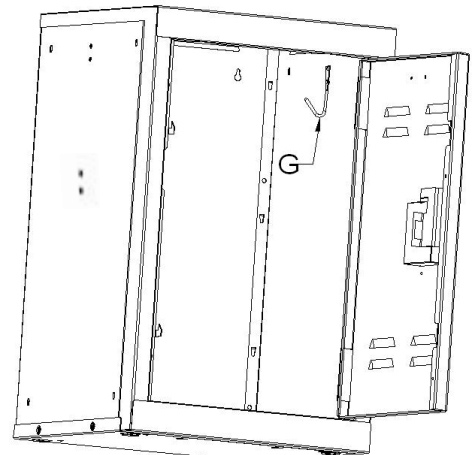

12

Stackable Individual Locker 24"



picture 1

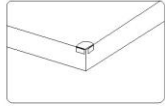

picture 2

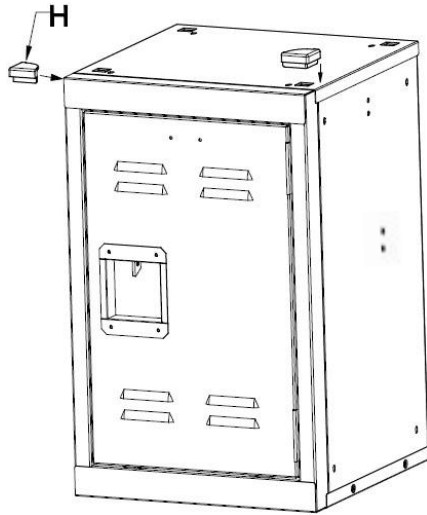
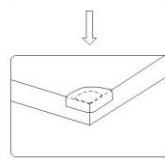

13

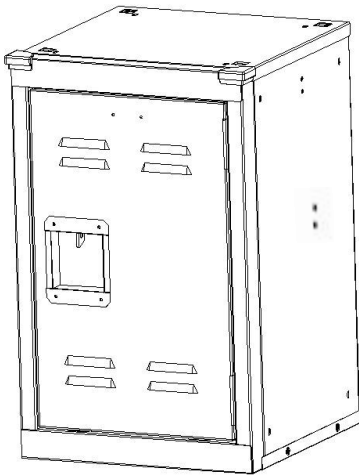

14

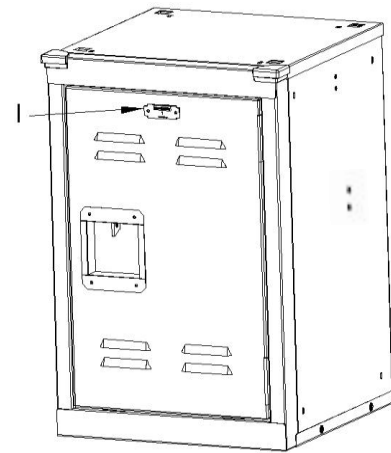

15

Stackable Individual Locker 24”

Written Instructions

1. Lay door frame horizontally on a clean flat surface. (Step 1)
2. Insert left and right panel horizontally, use 4 screws to secure.(Step 2-3)
3. Install the back panel horizontally, use 4 screws to secure. (Step 4-5)
4. Assemble bottom with 8 screws. (Step 6-8)
5. Assemble top with 2 screws. (Step 9-11)s
6. Install the 3 hooks (2 screws per hook). (Step 12)
7. 1) Clean the surface and apply 3M double sided tape to the two front corners. (picture 1)
2) Apply corner protectors and press firmly. (picture2) (Step 13-14)
8. Install number plate with two screws. (Step 15)

★★★ Safety warning

- A. Choking hazard. Keep small parts away from small children.
- B. Mind fingers when closing door.