

HARDWARE IDENTIFIER

TEAR OUT THIS PAGE

Illustrations on this page are to-scale for identification of hardware during assembly. **Tear out this page for quick reference.** Simply lay the hardware directly on top of the illustrations below to verify you're using the correct parts.

10 Bushing: Hex Head
3/8" x 1/2" (x2)
1001301

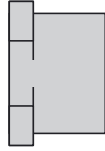

11 Nut: Nylon Lock
3/8" (x4)
B-4820

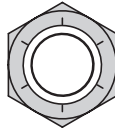

12 Nut: Nylon Lock
5/16" (x2)
B-4786

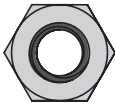

13 Nut: Hex Head
5/16" (x14)
30M1000P



17 Spring
(x1)
B-6300

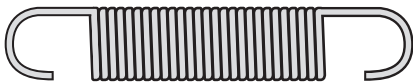

19 Bolt: Hex Head
3/8 x 1 1/4"
(x2)
2M1220P

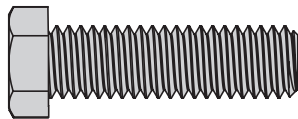

21 Bolt: Hex Head 3/8 x 3" (x2)
2M1248P



22 Grip: Flat
(for Handle)
(x1)
R-1882

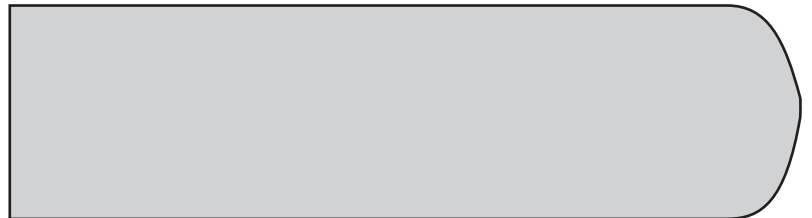

23 Drill Bit (x1)
1018992

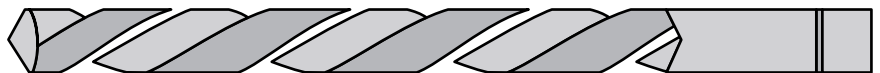

Exterior circumferences of the washers can vary. These dimensions are a measurement of the internal diameter of the washer.

14 Washer: Flat
3/8" (x2)
45M1313P

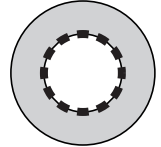

15 Washer: Lock
5/16" (x14)
40M1000P

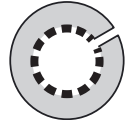

16 Washer: Flat
5/16" (x8)
45M1111P

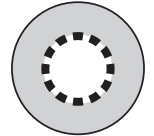

18 Bolt: Carriage
5/16 x 1" (x8)
11M1016P

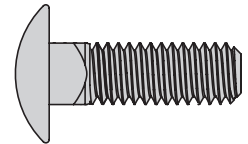

20 Screw:
Round Head
5/16 x 1" (x8)
20M1020P

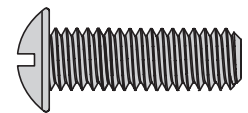

PARTS

REF	DESCRIPTION	Part#	QTY
1	Rocker Base Plate	1018681	1
2	Pivot Arm; Left	1018698	1
3	Pivot Arm; Right	1018697	1
4	Drilling Template; Pivot Arms	1018696	1
5	Pivot Bracket; Rear	1018684	2
6	A-Frame Support Bracket	1018687	1
7	Rocker Motion Bracket	1018682	1
8	Rocker Handle	1018881	1
9	Label; * "1. Release"	1018836	1

**not illustrated*

Hardware Bag (1018946)

10	Bushing, 3/8" x 1/2"	1001301	2
11	Nut; Nylon Lock, 3/8"	B-4820	4
12	Nut; Nylon Lock, 5/16"	B-4786	2
13	Nut; Hex Head, 5/16"	30M1000P	14
14	Washer; Flat, 3/8"	45M1313P	2
15	Washer; Lock, 5/16"	40M1000P	14
16	Washer; Flat, 5/16"	45M1111P	8
17	Spring	B-6300	1
18	Bolt; Carriage, 5/16" x 1"	11M1016P	8
19	Bolt; Hex Head, 3/8" x 1 1/4"	2M1220P	2
20	Screw; Round Head, 5/16" x 1"	20M1020P	8
21	Bolt; Hex Head, 3/8" x 3"	2M1248P	2
22	Grip, Flat	R-1882	1
23	Drill Bit	1018992	1

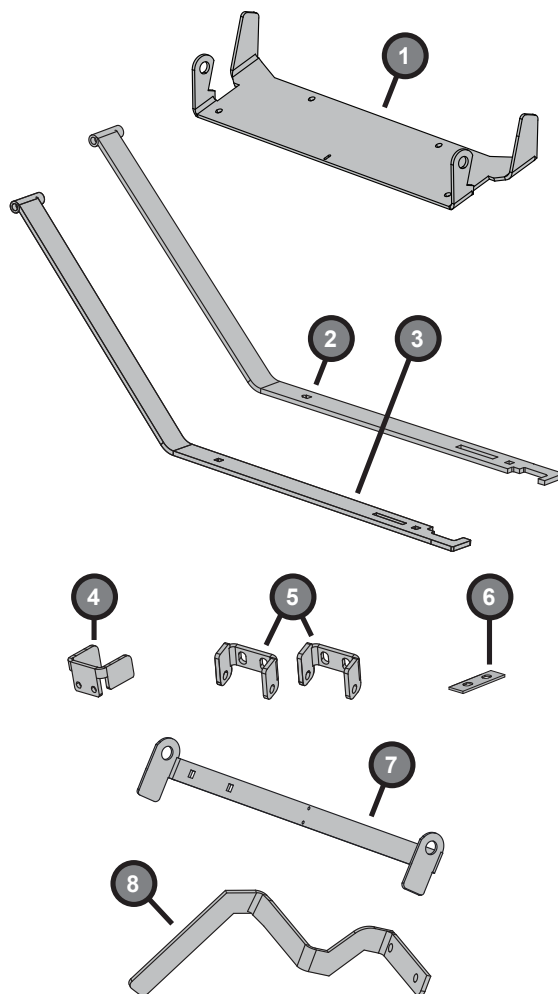

REQUIRED TOOLS FOR ASSEMBLY



- 1/2" Wrench
- 9/16" Wrench & Ratchet
- Flathead Screwdriver
- Drill (5/16" Bit included with kit)
- Gloves

If you have any installation questions, are missing parts or need replacement parts, don't go back to the store! Please contact our Customer Service department:



Call, Toll-Free: **877-728-8224**



Chat online: **www.brinly.com**



Email: **customerservice@brinly.com**