

Features

- No faucet holes.
- Includes cutout templates.
- Single basin.
- Includes 1 sink rack.

Material

- KOHLER Neoroc material.

Installation

- Under-mount installation.
- Strainer not included.

Recommended Accessories

K-9000 P-Trap
K-8801 Sink Strainer
K-8799 Sink Strainer

Components

Additional included component/s: K-5658.



ADA

Codes/Standards





CSA B45.5/IAPMO Z124
ADA
ICC/ANSI A117.1

KOHLER® Neoroc® Sinks Lifetime Limited Warranty

See website for detailed warranty information.

Available Color/Finishes

Color tiles intended for reference only.

Color	Code	Description
	CM1	Neoroc® Matte Black
	CM2	Neoroc® Matte Brown
	CM3	Matte Toupe
	CM4	Matte Grey

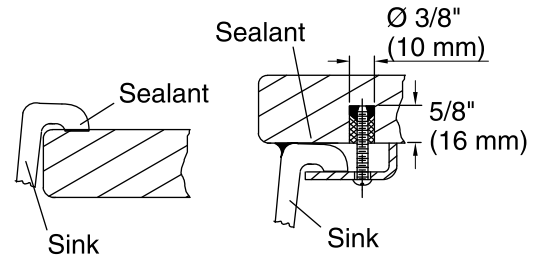
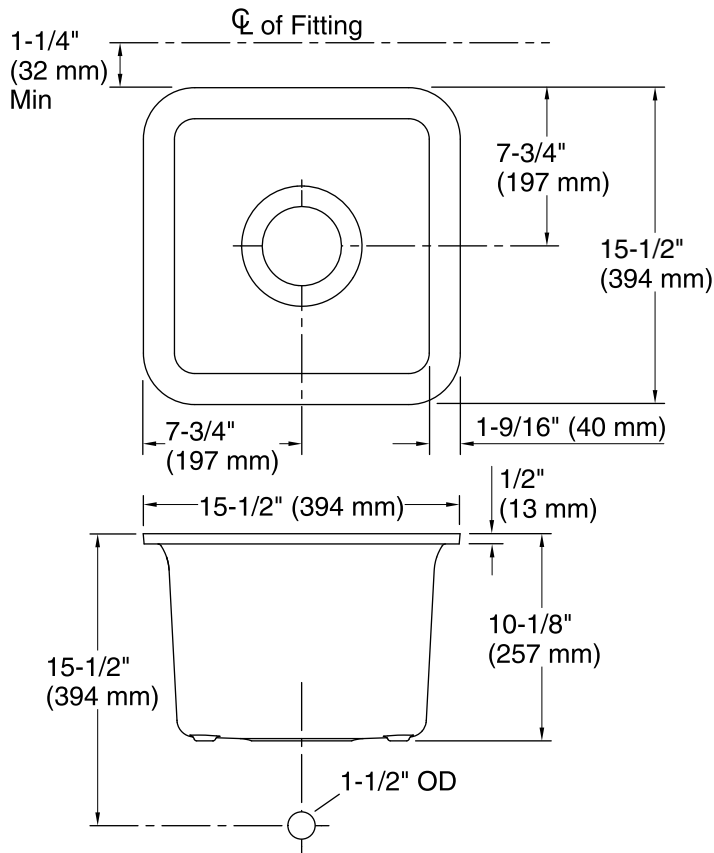

Top-Mount Installation

Under-Mount Installation

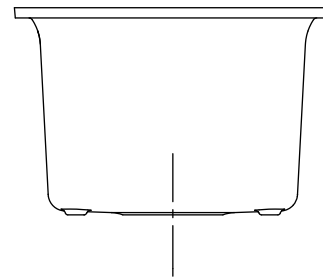

Technical Information

All product dimensions are nominal.

Installation:	Under-mount
Bowl area:	Length: 13-9/16" (344 mm) Width: 13-9/16" (344 mm) Bowl depth: 9-1/2" (241 mm) Water depth: 9-1/2" (241 mm)
Template:	1257826-7, required, included

Notes

Install this product according to the installation instructions.

ADA compliant when installed to the specific requirements of these regulations.