

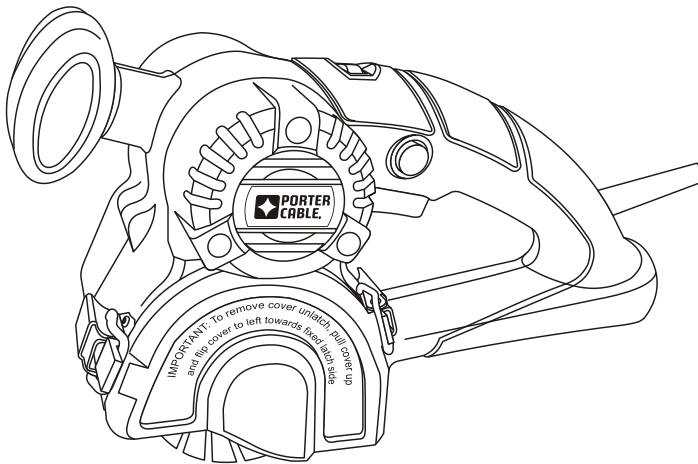

# 4" RESTORER

Model # PXRA2676

## Owner's Manual



PRODUCT SPECIFICATIONS	
Rating:	120 V, 60 Hz AC
Amperes:	3.5 A
Speed:	1,000 – 3,200 RPM (no load)
Sanding roller size:	2 <sup>13</sup> / <sub>16</sub> " (72mm) diameter 4" (100mm) wide
Weight:	4 lb. 8 oz. (2.0 kg)
<b>Need Assistance?</b> Call our toll free customer support line: (888) 848-5175	
<ul style="list-style-type: none"><li>• Technical questions</li><li>• Replacement parts</li><li>• Parts missing from package</li></ul>	

# TABLE OF CONTENTS

Product specifications .....	1
Table of contents .....	2
General safety warnings .....	3-4
Eye, ear & lung protection .....	3-4
Electrical safety .....	4
Power tool safety .....	5-6
General safety rules .....	5
Work area .....	5
Electrical safety .....	5
Personal safety .....	5-6
Power tool use and care .....	6
Service .....	6
Specific safety rules .....	7
Guidelines for extension cords .....	8
Symbols .....	9
Know your restorer .....	10
Assembly and operating .....	11-14
Changing sanding sleeve on roller .....	11
Variable speed control .....	11-12
ON/OFF trigger switch .....	12
Lock-on button .....	12
Sanding .....	13-14
Cleaning the tool .....	14
Maintenance .....	15
Exploded view .....	16
Parts list .....	17-18
Warranty .....	18

## GENERAL SAFETY WARNINGS



**WARNING:** Before using this tool or any of its accessories, read this manual and follow all Safety Rules and Operating Instructions. The important precautions, safeguards and instructions appearing in this manual are not meant to cover all possible situations. It must be understood that common sense and caution are factors which cannot be built into the product.

This instruction manual includes the following:

- General Safety Rules
- Specific Safety Rules and Symbols
- Functional Description
- Assembly
- Operation
- Maintenance
- Accessories

### EYE, EAR & LUNG PROTECTION



**ALWAYS WEAR EYE PROTECTION THAT CONFORMS WITH CAN/CSA STANDARD Z94.3 or ANSI SAFETY STANDARD Z87.1**

FLYING DEBRIS can cause permanent eye damage. Prescription eyeglasses ARE NOT a replacement for proper eye protection.



**WARNING:** Non-compliant eyewear can cause serious injury if broken during the operation of a power tool.



**WARNING:** Use hearing protection, particularly during extended periods of operation of the tool, or if the operation is noisy.

**SAVE THESE INSTRUCTIONS FOR REFERENCE**

## GENERAL SAFETY WARNINGS



**WEAR A DUST MASK THAT IS DESIGNED TO BE USED WHEN OPERATING A POWER TOOL IN A DUSTY ENVIRONMENT.**



**WARNING:** Dust that is created by power sanding, sawing, grinding, drilling, and other construction activities may contain chemicals that are known to cause cancer, birth defects, or other genetic abnormalities. These chemicals include:

- Lead from lead-based paints
- Crystalline silica from bricks, cement, and other masonry products
- Arsenic and chromium from chemically treated lumber

The level of risk from exposure to these chemicals varies, according to how often this type of work is performed. In order to reduce exposure to these chemicals, work in a well-ventilated area, and use approved safety equipment, such as a dust mask that is specifically designed to filter out microscopic particles.

## ELECTRICAL SAFETY



**WARNING: To avoid electrical hazards, fire hazards or damage to the tool, use proper circuit protection.**

This tool is wired at the factory for 120 V AC operation. It must be connected to a 120 V AC, 15 A circuit that is protected by a time-delayed fuse or circuit breaker. To avoid shock or fire, replace power cord immediately if it is worn, cut or damaged in any way.

**SAVE THESE INSTRUCTIONS FOR REFERENCE**

# POWER TOOL SAFETY



**▲ WARNING: Read all safety warnings and instructions.** Failure to follow the warnings and instructions may result in electric shock, fire and/or serious injury.

Save all warnings and instructions for future reference.

## WORK AREA SAFETY

**Keep work area clean and well lit.** Cluttered or dark areas invite accidents.

**Do not operate power tools in explosive atmospheres, such as in the presence of flammable liquids, gases or dust.** Power tools create sparks which may ignite the dust or fumes.

**Keep children and bystanders away while operating a power tool.** Distractions can cause you to lose control.

## ELECTRICAL SAFETY

**Power tool plugs must match the outlet. Never modify the plug in any way. Do not use any adapter plugs with earthed (grounded) power tools.** Unmodified plugs and matching outlets will reduce risk of electric shock.

**Avoid body contact with earthed or grounded surfaces such as pipes, radiators, ranges and refrigerators.** There is an increased risk of electric shock if your body is earthed or grounded.

**Do not expose power tools to rain or wet conditions.** Water entering a power tool will increase the risk of electric shock.

**Do not abuse the cord. Never use the cord for carrying, pulling or unplugging the power tool. Keep the cord away from heat, oil, sharp edges or moving parts.** Damaged or entangled cords increase the risk of electric shock.

**When operating a power tool outdoors, use an extension cord suitable for outdoor use.** Use of a cord suitable for outdoor use reduces the risk of electric shock.

**If operating a power tool in a damp location is unavoidable, use a residual current device (RCD) protected supply.** Use of a ground fault circuit interrupter (GFCI) reduces the risk of electric shock.

## PERSONAL SAFETY

**Stay alert, watch what you are doing and use common sense when operating a power tool. Do not use a power tool while you are tired or under the influence of drugs, alcohol or medication.** A moment of inattention while operating power tools may result in serious personal injury.

**Use personal protective equipment. Always wear eye protection.** Protective equipment such as dust mask, non-skid safety shoes, hard hat, or hearing protection used for appropriate conditions will reduce personal injuries.

**Prevent unintentional starting. Ensure the switch is in the off-position before connecting to power source and/or battery pack, picking up or carrying the tool.** Carrying power tools with your finger on the switch or energizing power tools that have the switch on invites accidents.

**Remove any adjusting key or wrench before turning the power tool on.** A wrench or a key left attached to a rotating part of the power tool may result in personal injury.

**Do not overreach. Keep proper footing and balance at all times.** This enables better control of the power tool in unexpected situations.

**Dress properly. Do not wear loose clothing or jewelry. Keep your hair, clothing and gloves away from moving parts.** Loose clothes, jewelry or long hair can be caught in moving parts.

**SAVE THESE INSTRUCTIONS FOR REFERENCE**

# POWER TOOL SAFETY

*Personal safety – cont'd*

**If devices are provided for the connection of dust extraction and collection facilities, ensure these are connected and properly used.** Use of dust collection can reduce dust-related hazards.

## POWER TOOL USE AND CARE

**Do not force the power tool. Use the correct power tool for your application.** The correct power tool will do the job better and safer at the rate for which it was designed.

**Do not use the power tool if the switch does not turn it on and off.** Any power tool that cannot be controlled with the switch is dangerous and must be repaired.

**Disconnect the plug from the power source and/or the battery pack from the power tool before making any adjustments, changing accessories, or storing power tools.** Such preventive safety measures reduce the risk of starting the power tool accidentally.

**Store idle power tools out of the reach of children and do not allow persons unfamiliar with the power tool or these instructions to operate the power tool.** Power tools are dangerous in the hands of untrained users.

**Maintain power tools. Check for misalignment or binding of moving parts, breakage of parts and any other condition that may affect the power tool's operation. If damaged, have the power tool repaired before use.** Many accidents are caused by poorly maintained power tools.

**Keep cutting tools sharp and clean.** Properly maintained cutting tools with sharp cutting edges are less likely to bind and are easier to control.

**Use the power tool, accessories and tool bits etc. in accordance with these instructions, taking into account the working conditions and the work to be performed.** Use of the power tool for operations different from those intended could result in a hazardous situation.

**Hold power tool by insulated gripping surfaces, because the abrasive sleeve may contact its own cord.** Cutting a "live" wire may make exposed metal parts of the tool "live" and could give the operator an electric shock.

## SERVICE

**Have your power tool serviced by a qualified repair person using only identical replacement parts.** This will ensure that the safety of the power tool is maintained.

**SAVE THESE INSTRUCTIONS FOR REFERENCE**

## SPECIFIC SAFETY RULES

**⚠ WARNING:** Know your Restorer. Do not plug in the Restorer until you have read and understand this Instruction Manual. Learn the tool's applications and limitations, as well as the specific potential hazards related to this tool. Following this rule will reduce the risk of electric shock, fire, or serious injury.



Always wear eye protection. Any power tool can throw foreign objects into your eyes and cause permanent eye damage. ALWAYS wear safety goggles (not glasses) that comply with CAN/CSA Standard Z94.3 or ANSI safety standard Z87.1. Everyday glasses have only impact resistant lenses. They ARE NOT safety glasses.

**⚠ WARNING:** Glasses or goggles not in compliance with ANSI Z87.1 could cause serious injury when they break.

**⚠ WARNING:** Always use a dust mask when sanding or stripping paint.

**⚠ WARNING:** Always use hearing protection when using this tool, particularly during extended periods of operation.

**⚠ WARNING:** Always unplug the tool from the power source before changing the roller, sanding cylinder, accessory and when cleaning the tool.

**⚠ WARNING:**  **FIRE HAZARD:** Never use this tool near explosive atmosphere or combustible materials. If the sandpaper hits a nail or any ferrous metal, a spark could cause an explosion of fire.

**⚠ WARNING:**  **FIRE HAZARD:** Collected sanding dust from sanding coatings such as polyurethane, linseed oil etc. can self-ignite. To reduce the risk, clear dust frequently from the sanding drum area and from the surrounding work area. Strictly follow the cleaning instructions in the Owner's Manual and coating manufacturer's instructions.

**⚠ WARNING:** Always use safety goggles and a dust mask when using compressed air to remove sanding dust from the tool.

**⚠ WARNING:** Make sure the roller has come to a full stop before taking your hands off the tool. If the roller is still moving, the tool may move erratically and either damage the workpiece or cause injury to the user.

Always place the Restorer on its "nose" (balanced between the front handle and the roller housing) when the tool is turned OFF and when storing the tool. This will prevent inadvertent loss of control if the tool is accidentally turned ON. It will also avoid the roller from developing a flat spot if the tool is stored for long periods of time with weight on the roller.

Always use two hands when operating the Restorer. One hand should be used on the front handle and the other hand should be placed on the rear handle to operate the switches. Using both hands will provide better control over the tool.

Do not wear gloves, neckties or loose clothing.

Secure the workpiece. Use clamps or a vise to hold the work when practical. It is safer than using your hand and it frees both hands to operate the tool.

Do not use this tool on material too small to be securely held.

Make sure there are no nails or foreign objects in the part of the workpiece to be sanded or cleaned.

Always keep hands out of the path of the roller. Avoid awkward hand positions where a sudden slip could cause your hand to move into the path of the roller.

**SAVE THESE INSTRUCTIONS FOR REFERENCE**

# GUIDELINES FOR EXTENSION CORDS

**Make sure your extension cord is the proper size.** When using an extension cord, be sure to use one heavy enough to carry the current the tool will draw. An undersized cord will cause a drop in line voltage resulting in loss of power and overheating. The table at right shows the correct size to use according to cord length and nameplate ampere rating. If in doubt, use the next heavier gauge. The smaller the gauge number the heavier the cord.

**Be sure your extension cord is properly wired and in good condition.** Always replace a damaged extension cord or have it repaired by a qualified electrician before using it. Protect your extension cord from sharp objects, excessive heat and damp or wet areas.

**Use a separate electrical circuit for your power tools.** This circuit must not be less than 14 gauge wire and should be protected with either a 15A time delay fuse or circuit breaker. Before connecting the power tool to the power source, make sure the switch is in the OFF position and the power source is the same as indicated on the nameplate. Running at lower voltage will damage the motor.

**⚠ WARNING: Repair or replace damaged or worn extension cords immediately.**

**Select the appropriate extension cord gauge and length using the chart at right.**

**When operating a power tool outdoors, use an outdoor extension cord marked “W-A” or “W”.** These cords are rated for outdoor use and reduce the risk of electric shock.

**⚠ WARNING: Keep the extension cord clear of the working area. Position the cord so it will not get caught on the workpiece, tools or any other obstructions while you are working with the power tool.**





<b>MINIMUM GAUGE (AWG) EXTENSION CORDS (120 V use only)</b>					
Ampere rating		Total length in feet			
More than	Not more than	7.5 m (25')	15 m (50')	30 m (100')	45 m (150')
0	6	18	16	16	14
6	10	18	16	14	12
10	12	16	16	14	12
12	16	14	12	Not Applicable	













**SAVE THESE INSTRUCTIONS FOR REFERENCE**



# SYMBOLS

**▲ WARNING:** Some of the following symbols may appear on the Restorer. Study these symbols and learn their meaning. Proper interpretation of these symbols will allow for more efficient and safer operation of this tool.

V	Volts
A	Amperes
Hz	Hertz
W	Watts
kW	Kilowatts
μF	Microfarads
L	Liters
kg	Kilograms
H	Hours
N/cm <sup>2</sup>	Newtons per square centimeter
Pa	Pascals
OPM	Oscillations per minute
Min	Minutes
S	Seconds
 or a.c.	Alternating current
	Three-phase alternating current
	Three-phase alternating current with neutral
	Direct current

$n_0$	No load speed
	Alternating or direct current
	Class II construction
	Splash-proof construction
	Watertight construction
	Protective grounding at grounding terminal, Class I tools
.../min	Revolutions or reciprocations per minute
∅	Diameter
0	Off position
	Directional arrow
	Warning symbol
	Wear your safety glasses
	Wear a dust mask
	Wear hearing protection
	Fire hazard
	Read all instructions



This symbol designates that this tool Conforms to UL Std. 60745-1, 60745-2-4 and is Certified to CAN/CSA Std.C22.2 No. 60745-1, 60745-2-4 by ETL Testing Laboratories, Inc.

# KNOW YOUR RESTORER

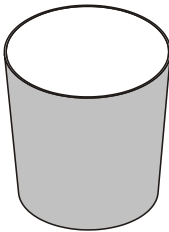
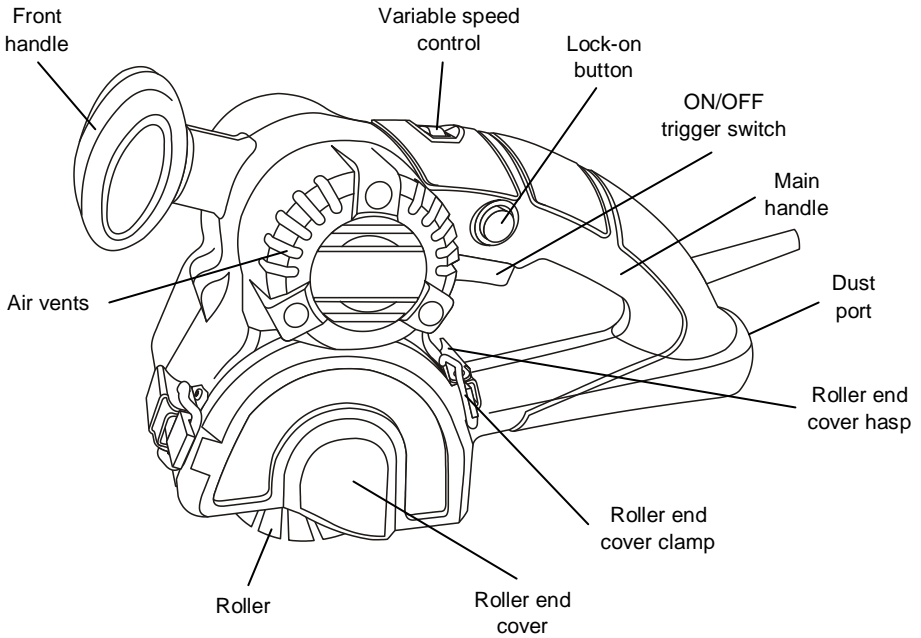

Coarse sanding sleeve (2)

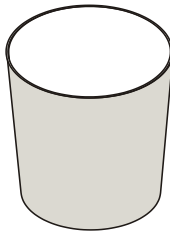

Medium sanding sleeve (2)

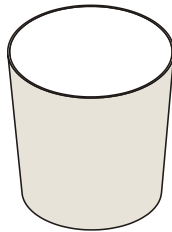

Fine sanding sleeve (2)

# ASSEMBLY AND OPERATING

## CHANGING SANDING SLEEVE ON ROLLER

**⚠ WARNING:** Remove the plug from the power source before installing or removing a sanding roller.

1. Lift the two roller end cover hasps (1) away from the main housing (2) (Fig. 1).

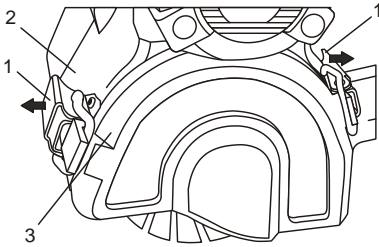

Fig. 1

2. Release the RIGHT hasp from the roller end cover (3).
3. Pull the cover out from the main housing and flip it toward the front of the tool using the LEFT hasp as a hinge (Fig 2).
4. Slide the roller (4) off the roller shaft (5).

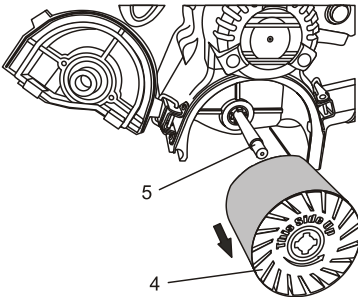

Fig. 2

5. Remove the old sanding sleeve and slide the new sanding sleeve (6) onto the roller (4) (Fig. 3).  
**NOTE:** Rotate the roller sleeve counter-clockwise as you slide the roller sleeve fully onto the roller. Make sure it is centered on the roller and is not overhanging one end of the roller.

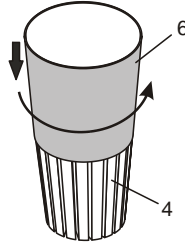

Fig. 3

6. Slide the roller onto the roller shaft (Fig. 4).  
**NOTE:** The roller can only be installed one way. When properly installed, the directional arrow (7) on the end of the roller will be visible.

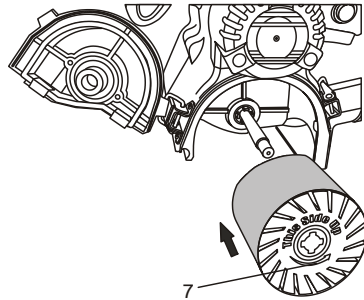

Fig. 4

7. Reinstall the roller end cover and fasten it in place with the two roller end cover hasps.  
**CAUTION:** Make sure the roller end cover is properly seated onto the main housing and the hasps snap into place.

## VARIABLE SPEED CONTROL

The variable speed control (1) can be rotated to change the speed at which the roller will rotate (Fig. 5). Rotate the speed control to the LEFT (#1) for slowest speed and to the right (MAX) for the fastest speed.

**NOTE:** See "SANDING" section of this manual for recommended speeds.

# ASSEMBLY AND OPERATING

## VARIABLE SPEED CONTROL – cont'd

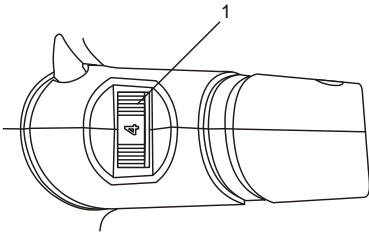

Fig. 5

## ON/OFF TRIGGER SWITCH

The ON/OFF trigger switch (1) is a single function switch (Fig. 6). To turn the tool ON, squeeze the trigger. To turn the tool OFF, release the trigger.

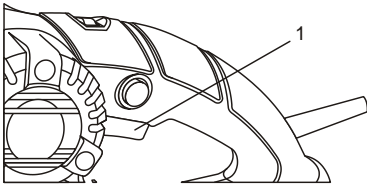

Fig. 6

## LOCK-ON BUTTON

The lock-on button (2) is used to lock the ON/OFF trigger switch in the ON position (Fig. 7). Locking the trigger switch in the ON position will reduce hand fatigue when operating the tool for extended periods of time.

1. To lock the trigger switch in the ON position, squeeze the trigger (1) to turn the tool ON.
2. While squeezing the trigger, press the lock-on button (2) into the handle.
3. While holding the lock-on button into the handle, release the trigger. At this point, the tool will remain running.
4. To release the lock-on button to turn the tool OFF, squeeze and then release the trigger. The trigger switch will then turn OFF.

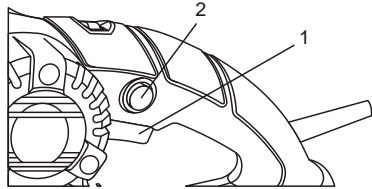

Fig. 7

**⚠ WARNING:** Be sure the lock button is not depressed by cycling the ON/OFF switch several times or by depressing and releasing the switch several times before plugging in your restorer. Damage to your tool or personal injury may result.

### **⚠ WARNING**

For safety reasons, the operator must read the sections of this Owner's Manual entitled "GENERAL SAFETY WARNINGS", "POWER TOOL SAFETY", "SPECIFIC SAFETY RULES", "GUIDELINES FOR EXTENSION CORDS" and "SYMBOLS" before using this Restorer.

Verify the following every time the Restorer is used:

1. There are no flammable or explosive materials in the work area.
2. Restorer cord is not damaged.
3. Safety glasses and dust mask are being worn.
4. Hearing protection is being worn.
5. Sanding sleeve is the correct type for the job.
6. Sanding sleeve is in good condition and is properly installed.

Failure to observe these safety rules will significantly increase the risk of injury.

# ASSEMBLY AND OPERATING

## SANDING

This tool can be used to sand rough material or to remove paint, varnish or other finishes.

**▲ WARNING:** Always use safety glasses, dust mask and hearing protection when operating this tool. Failure to wear these protective devices may cause serious injuries.

**▲ WARNING:** Never use this tool near flammable materials. A spark from sanding hidden fasteners could ignite flammable materials.

**▲ WARNING:** An unsecured workpiece could be thrown toward the operator causing injury.

**▲ WARNING:** Clamp or otherwise secure your workpiece to prevent it from moving under the Restorer while being sanded.

**▲ WARNING:** Always use two hands to operate this tool. One hand should be on the front handle and the other on the rear handle. Failure to use two hands may cause the tool to be difficult to control and possibly cause serious injury to the operator.

Do NOT cover the cooling vents in the tool. This will cause the tool to overheat and damage the tool.

Before starting any sanding project, you should practice sanding on a scrap workpiece similar to the item to be sanded. This will allow you to get the "feel" of the tool and also establish the grit of the sanding sleeve and tool speed to best suit the type of material being sanded.

In general, removing heavier finishes and when sanding rough surfaces, a coarser sanding sleeve and slower tool speeds are recommended. Slower speeds will reduce the heat created while sanding and reduce the tendency of the sanding sleeve to become clogged. For sanding smoother surfaces without finishes, finer sanding sleeves and higher tool speeds are recommended.

To begin sanding, install the appropriate sanding sleeve, set the tool speed and squeeze the trigger switch to turn the tool ON.

**NOTE:** The sanding sleeve should NOT be in contact with the workpiece until it has reached its operating speed.

Once the tool has reached its operating speed, hold onto the tool with both hands and carefully bring the sanding sleeve into contact with the workpiece.

**NOTE:** When the sanding sleeve contacts the workpiece, the tool will tend to be pulled forward away from you. Make sure you have a firm grip on the tool with **both** hands.

**DO NOT FORCE THE RESTORER.** The weight of the Restorer usually provides adequate pressure. Let the Restorer and the sandpaper do the work. Applying added pressure will slow the motor, increase the wear on the sanding sleeve and greatly reduce the tool speed. Motor damage may occur if excessive downward pressure is applied. It will also create an inferior finish on sanded work. Any finish or resin on wood will soften from the frictional heat, causing the sanding sleeve to become clogged very quickly. Do not sand in one spot as the sanding sleeve will remove too much material, making the surface uneven.

When sanding wood, always move the Restorer forward and backward with the grain (Fig. 8). Sanding across the grain will not leave a smooth surface.

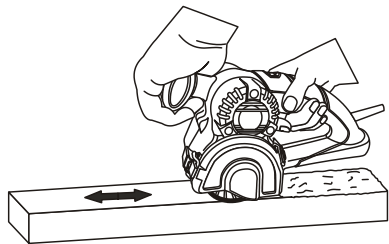

**Fig. 8**

# ASSEMBLY AND OPERATING

## SANDING – cont'd

Always keep the tool "moving" when the sanding sleeve is in contact with the workpiece. This is particularly important when sanding wood or other soft materials. Failure to keep the tool "moving" will result in gouges in the workpiece.

Do not allow sanding dust to accumulate in the tool. Stop and clean out all loose sanding dust at regular intervals to prevent unnecessary buildup that will cause the tool to be inefficient and to guard against overheating. Refer to "CLEANING THE TOOL" for details.

Always place the Restorer on its "nose" (balanced between the front handle and the roller housing) when the tool is turned OFF and when storing the tool (Fig. 9). This will prevent inadvertent loss of control if the tool is accidentally turned ON. It will also prevent the roller from developing a flat spot if the tool is stored for long periods of time with weight on the roller.

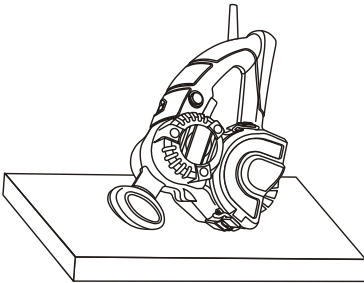

Fig. 9

## CLEANING THE TOOL

It is important to keep the tool as clean as possible to reduce the risk of fire and to produce the best possible sanding results.

**▲ WARNING:** Always remove the plug from the power source before removing the sanding roller and before cleaning the tool.

**▲ WARNING:** Always wear safety goggles and a dust mask when using compressed air to remove sanding dust from the tool.

**▲ WARNING:** Do not at any time allow brake fluids, gasoline, petroleum-based products, penetrating oils, etc. to come in contact with plastic parts. They contain chemicals that can damage, weaken or destroy plastic.

1. Unlatch the roller end cover (Fig. 1).
2. Remove the roller from the tool.
3. Remove the sanding sleeve from the roller.
4. Use compressed air to blow all the loose sanding dust from the:
  - roller housing,
  - roller end cover,
  - slots in the roller, and
  - dust chute in the back of the rear handle.

**NOTE:** If compressed air is not available, use a soft DRY long bristled brush to remove the sanding dust.

Use a clean, dry cloth to remove sanding dust from the other tool components.

**NOTE:** Do **NOT** use any solvents or water on the cloth.

# MAINTENANCE

## GENERAL

**⚠ WARNING: When servicing, use only identical replacement parts. Use of any other replacement parts may create a hazard or cause product damage.**

DO NOT use solvents when cleaning plastic parts. Most plastics are susceptible to damage from various types of commercial solvents and may be damaged by their use. Use a clean cloth to remove dirt, dust, oil, grease, etc.

**⚠ WARNING: Do not at any time allow brake fluids, gasoline, petroleum-based products, penetrating oils, etc. to come in contact with plastic parts. They contain chemicals that can damage, weaken or destroy plastic.**

DO NOT abuse power tools. Abusive practices can damage the tool as well as the workpiece.

**⚠ WARNING: DO NOT attempt to modify tools or create accessories not recommended. Any such alteration or modification is misuse and could result in a hazardous condition leading to possible serious injury. It will also void the warranty.**

It has been found that electric tools are subjected to accelerated wear and possible premature failure when they are used on fiberglass boats and automotive parts, wallboard, spackling compounds or plaster. The chips and grindings from these materials are highly abrasive to electric tool parts such as bearings, brushes, commutators, etc. Consequently, it is not recommended that this tool be used for extended work on any fiberglass material, wallboard, spackling compounds or plaster. During any use on these materials it is extremely important that the tool is cleaned frequently by blowing the dust out of the tool with an air jet. See "CLEANING THE TOOL" section of this manual for details.

**⚠ WARNING: Always wear safety goggles or safety glasses with side shields during all sanding operations. It is critical that you also wear safety goggles or safety glasses with side shields and a dust mask while blowing dust out of the Restorer with an air jet. Failure to take these safety precautions could result in permanent eye or lung damage.**

## LUBRICATION

All of the bearings in this restorer are lubricated with a sufficient amount of high grade lubricant for the life of the unit under normal conditions. Therefore, no further lubrication is required.

# EXPLODED VIEW

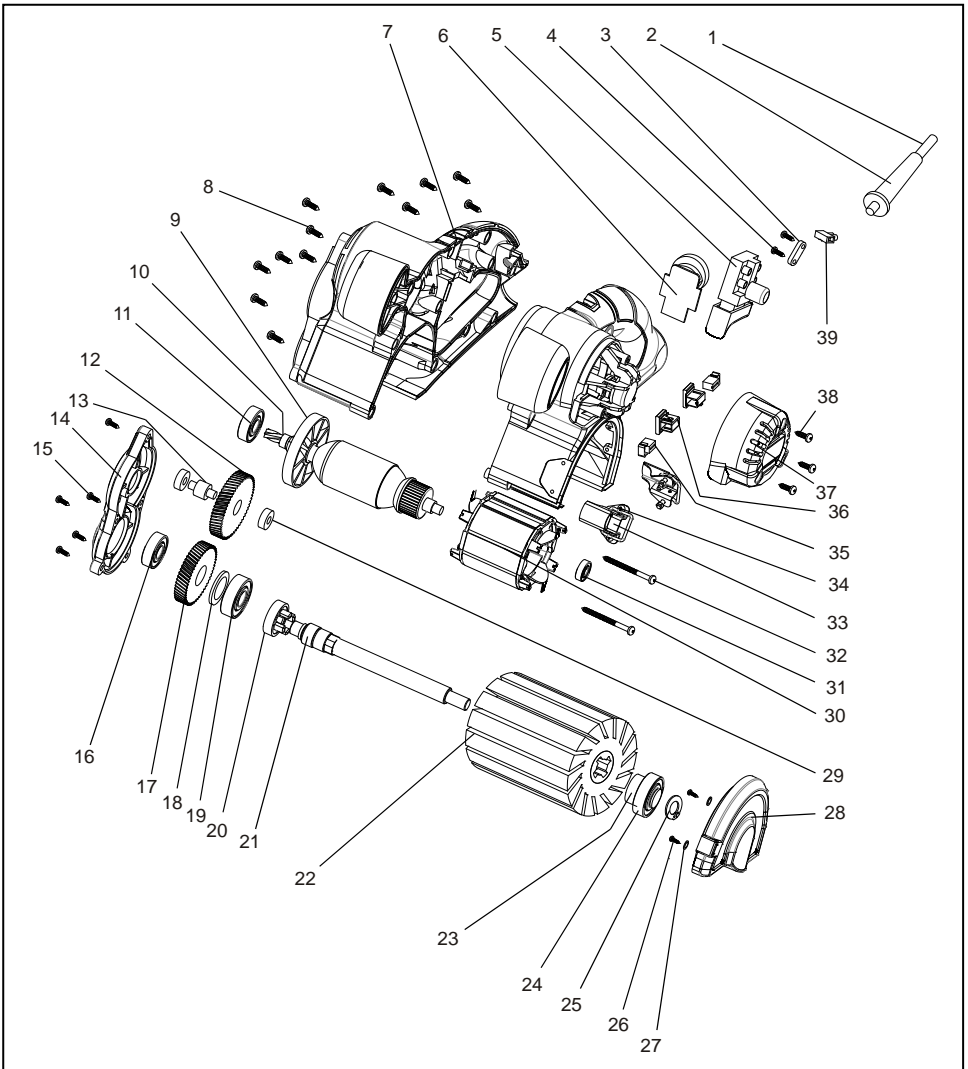



# PARTS LIST

**▲ WARNING:** When servicing, use only original equipment replacement parts. The use of any other parts may create a safety hazard or cause damage to the Restorer.

**▲ WARNING:** To assure SAFETY and RELIABILITY of repairs, maintenance and accessories, the use of any accessory not recommended for use with this tool could be hazardous. Recommended accessories for use with your tool are available from your local dealer or authorized service center. If you need assistance regarding accessories, please call the toll-free helpline at 1-866-349-8665 (Monday through Friday 9:00am – 5:00pm Eastern Time).

Any attempt to repair or replace electrical parts on this Restorer may create a safety hazard unless repairs are performed by a qualified technician. For more information, call the toll-free helpline, at 1-866-349-8665 (Monday through Friday 9:00am – 5:00pm Eastern Time).

**Always order by PART NUMBER, not by key number.**

Key #	Part #	Part Name	Quantity
1	1190030064	Cord & plug	1
2	3140010054	Cord sleeve	1
3	4030010099	Tapping screw ST3.9x14	2
4	2030050002	Strain relief	1
5	1061260001	Switch	1
6	1130010248	Circuit board	1
7	3011300001	Housing	1
8	4030010106	Tapping screw ST3.9X19	12
9	3150010116	Fan	1
10	1010310001	Rotor	1
11	4010010054	Bearing 6000 2RS	1
12	2040080048	Transmission gear	1
13	2040040116	Gear shaft	1
14	3150070101	Gear cover	1
15	4030010099	Tapping screw ST3.9X14	5
16	4010010043	Bearing 6000 Z	1
17	2040080049	Output gear	1
18	2030170007	bearing washer	1
19	4010010086	Bearing 6002 Z	1
20	2040310051	Coupling sleeve	1
21	2040040117	Output shaft	1
22	6300010003	Roller	2
23	2040310052	Quick coupling sleeve	2
24	4010010084	Bearing 6002 2RS	2
25	4100020010	Spring washer $\Phi$ 14	1
26	4030010180	Tapping screw ST3.9X10	2
27	2030020269	Bearing washer	2
28	3160010073	Rear cover	1
29	4010010042	Bearing 696	2
30	1020310001	Stator	1
31	4010010053	Bearing 607 2RS	1
32	4030010169	Tapping screw ST3.9X55	2
33	2030030281	Hasp	2

# PARTS LIST

Key #	Part #	Part Name	Quantity
34	4030010008	Tapping screw ST2.5X8	4
35	1230010146	Carbon brush	2
36	2030070053	Brush holder	2
37	3160010072	Motor cover	1
38	4030010106	Tapping screw ST3.9X19	3
39	1250010002	Terminal block	1

## THREE YEAR LIMITED WARRANTY

**PORTER-CABLE** will repair, without charge, any defects due to faulty materials or workmanship for three years from the date of purchase. This warranty does not cover part failure due to normal wear or tool abuse. For further detail of warranty coverage and warranty repair information, visit [www.portercable.com](http://www.portercable.com) or call (888) 848-5175. This warranty does not apply to accessories or damage caused where repairs have been made or attempted by others. This warranty gives you specific legal rights and you may have other rights which vary in certain states or provinces.

In addition to the warranty, PORTER-CABLE tools are covered by our:

**1 YEAR FREE SERVICE:** PORTER-CABLE will maintain the tool and replace worn parts caused by normal use, for free, any time during the first year after purchase.

**90 DAY MONEY BACK GUARANTEE:** If you are not completely satisfied with the performance of your PORTER-CABLE Power Tool, Laser, or Nailer for any reason, you can return it within 90 days from the date of purchase with a receipt for a full refund – no questions asked.

To register your tool for warranty service, visit our website at [www.portercable.com](http://www.portercable.com).

**LATIN AMERICA:** This warranty does not apply to products sold in Latin America. For products sold in Latin America, see country specific warranty information contained in the packaging, call the local company or see website for warranty information.