



Item # 741 609  
Model #176-411-7D-V2

## USE AND CARE GUIDE

---

### Oak Cliff 7-Piece Patio Dining Set with Chili Cushions (Table)



Questions, problems, missing parts? Before returning to the store,  
call Hampton Bay Customer Service  
8.00 a.m. - 7.00 p.m. EST, Monday - Friday,  
9.00 a.m. - 6.00 p.m. EST, Saturday

**1-855-HD-HAMPTON**

**HAMPTONBAY.COM**

---

**THANK YOU**

*We appreciate the trust and confidence you have placed in Hampton Bay through the purchase of this 7-piece set . We strive to continually create quality products designed to enhance your home. Visit us online to see our full line of products available for your home improvement needs. Thank you for choosing Hampton Bay!*

# Table of Contents

Table of Contents.....	2	Pre-Assembly.....	3
Safety Information.....	2	Planning Assembly.....	3
Warranty.....	2	Hardware Included.....	3
2 Year Frame Limited Warranty.....	2	Package Contents.....	4
What Is Covered ..	2	Assembly .....	5
What Is Not Covered ..	2		
Care Instructions.....	2		

# Safety Information



**CAUTION:** Please keep children out of the assembly area during assembly .



**WARNING:** Do not stand or sit on the table. Do not put heavy objects on the table.



**CAUTION:** Use the table on flat ground only.

# Warranty

## TWO YEAR FRAME LIMITED WARRANTY

### WHAT IS COVERED

We warrant the frame to be free of manufacturing defects to the original purchaser for two years.

### WHAT IS NOT COVERED

It remains the customer's responsibility for freight and packaging charges to and from our service center. This warranty does not cover commercial use, hardware, acts of nature, fire, freezing and abusive use. In addition, purchased parts are not covered under this warranty. We reserve the right to make substitutions with similar merchandise, if the model in question is no longer in production.

# Care Instructions

Before using, wipe with a clean, dry cloth. Do not use bleach or solvents. Treat frame with one step liquid wax for maximum protection against UV light and salty, damp air. When not in use, store furniture in a cool, dry place. If your set includes cushions, they may be cleaned by hand with a mild solution of soap and water. Rinse cushion thoroughly and allow to drip dry. Do not machine wash or tumble dry, as cushions may shrink. Do not use bleach or solvents on fabrics. When cleaning the tabletop make sure to use a soft, clean cloth that doesn't bleed color as well.

You may contact our customer service department with any questions by phone at 1-855-HD-HAMPTON or visit [www.hamptonbay.com](http://www.hamptonbay.com).

# Pre-Assembly

## PLANNING ASSEMBLY

It will take two people about 10 minutes to complete the assembly process.

## HARDWARE INCLUDED



**NOTE:** Hardware not shown to actual size.

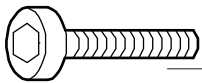

AA

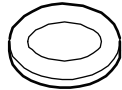

BB



CC

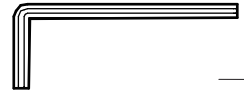

DD

Part	Description	Quantity
AA	Bolt (M6x15)	12
BB	Washer	12
CC	Bolt cap	12
DD	Hex wrench	1

# Pre-Assembly (continued)

## PACKAGE CONTENTS

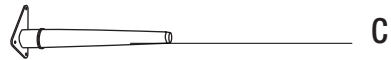
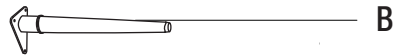
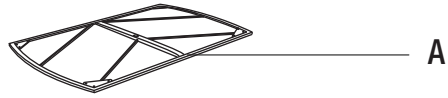

Part	Description	Quantity
A	Table top	1
B	Table leg	2
C	Table leg	2

# Assembly

## 1 Attaching the table legs

- Place the table top (A) upside down on a flat, smooth surface.
- Align the table legs (B and C) to the table top (A).
- Secure the table legs (B and C) to the table top (A) with washers (BB) and bolts (AA) using the hex wrench (DD).
- Fully tighten all bolts (AA) once all bolts (AA) are in place. Cover all bolts with bolt caps (CC).

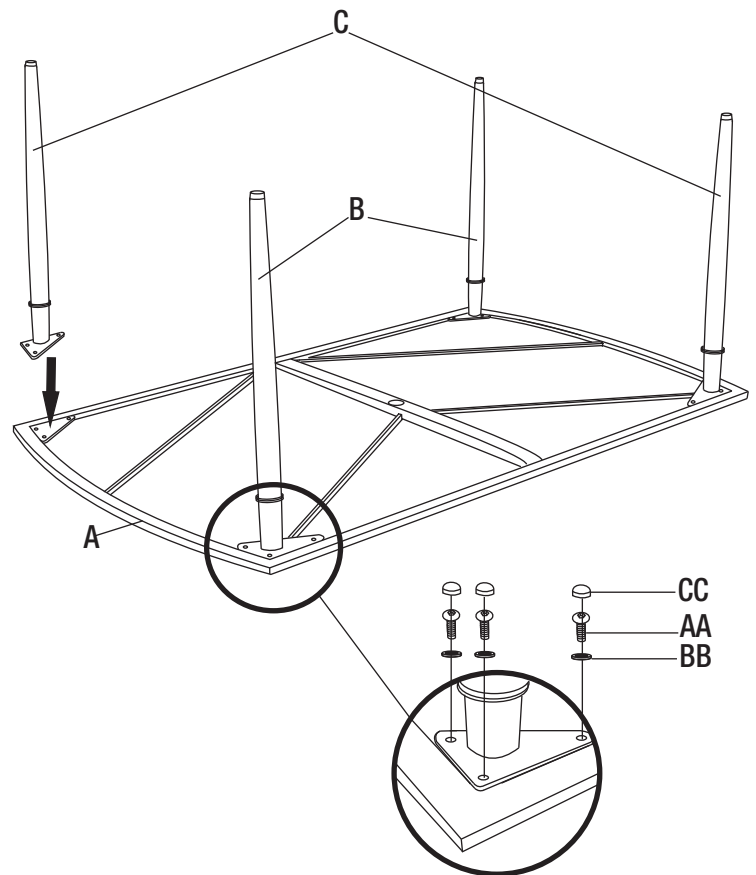

## 2 Stabilizing the table

- Turn the table upright.
- Level the table with glides at the bottom of the table legs.



**IMPORTANT:** Please always have an umbrella base ready if you plan to set an umbrella in the center of the table.



**CAUTION:** You must remove the umbrella from the table when not in use. Failure to do so may result in damage to the table top. This type of damage is not considered under the limited warranty.



Questions, problems, missing parts? Before returning to the store,  
call Hampton Bay Customer Service  
8.00 a.m. - 7.00 p.m. EST, Monday - Friday,  
9.00 a.m. - 6.00 p.m. EST, Saturday

**1-855-HD-HAMPTON**

**HAMPTONBAY.COM**

Retain this manual for future use.