

# INSTALLATION INSTRUCTIONS

## Preview Installation Order

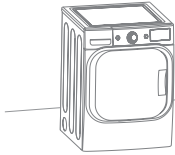

Checking and choosing the proper location



Leveling the dryer

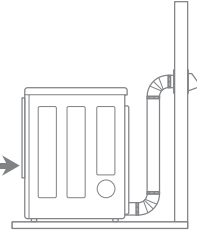

Venting the dryer

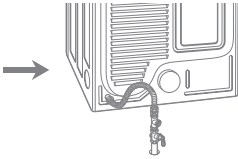

Connecting gas dryers

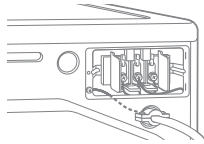

Connecting electric dryers

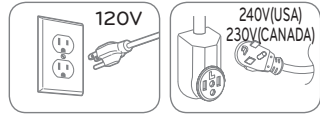

Plugging in the power cord and grounding

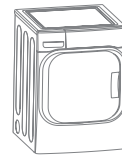

Exhaust check test  
(Refer to page 30.)

Test run

## Installation Location Requirements

### ⚠ WARNING

**Read all installation instructions completely before installing and operating your dryer!** It is important that you review this entire manual before installing and using your dryer. Detailed instructions concerning electrical connections, gas connections, and exhaust requirements are provided on the following pages.

- A location that allows for proper exhaust installation. A gas dryer must be exhausted to the outdoors. See **Venting the dryer**.
- A sturdy floor to support the total dryer weight of 200 lbs (90.7 kg). The combined weight of a companion appliance should also be considered.
- A grounded electrical outlet located within 2 ft. (61 cm) of either side of the dryer. See **Connecting electric dryers**.
- No other fuel-burning appliance can be installed in the same closet as a dryer.

Do not operate your dryer at temperatures below 45°F (7°C). At lower temperatures, the dryer might not shut off at the end of an automatic cycle. This can result in longer drying times. The dryer must not be installed or stored in an area where it will be exposed to water and/or weather. Check code requirements. Some codes limit, or do not permit, installation of the dryer in garages, closets, mobile homes or sleeping quarters. Contact your local building inspector.

### ! NOTE

- A level floor with a maximum slope of 1 inch (2.5 cm) under entire dryer. If slope is greater than 1 inch (2.5 cm), install the Extended Dryer Feet Kit. Clothes may not tumble properly, and automatic sensor cycles may not operate correctly if dryer is not level.
- For a garage installation, you will need to place the dryer at least 18 inches (46 cm) above the floor. If using a pedestal, you will need 18 inches (46 cm) to the bottom of the dryer.

## Clearances

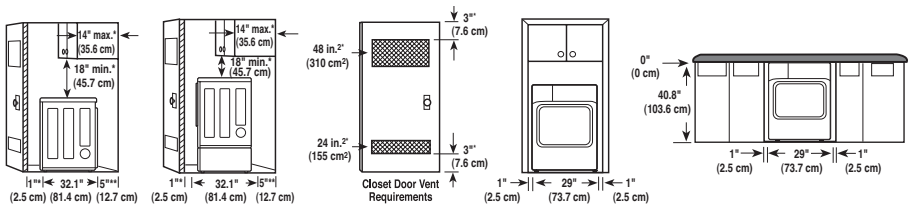

### Installation Spacing For Recessed Area Or Closet Installation

The following spacing dimensions are recommended for this dryer. This dryer has been tested for spacing of 1 inches (2.54cm) clearance on the sides and rear. Recommended spacing should be considered for the following reasons:

- Additional spacing should be considered for ease of installation and servicing.
- Additional clearances might be required for wall, door and floor moldings.
- Additional spacing should be considered on all sides of the dryer to reduce noise transfer.
- For closet installation, with a door, minimum ventilation openings in the top and bottom of the door are required. Louvered doors with equivalent ventilation openings are acceptable.
- Companion appliance spacing should also be considered.

### ! NOTE

There should be at least a little space around the dryer (or any other appliance) to eliminate the transfer of vibration from one to the other. Too much vibration, it could cause them to make noise or touch each other causing paint damage and making even more noise.

## Installation location requirements (Cont.)

### **⚠ WARNING**

**Read all installation instructions completely before installing and operating your dryer!** It is important that you review this entire manual before installing and using your dryer. Detailed instructions concerning electrical connections, gas connections, and exhaust requirements are provided on the following pages.

- A location that allows for proper exhaust installation.
  - A gas dryer must be exhausted to the outdoors. See **Venting Requirements(P.20)**.
- A sturdy floor to support the total dryer weight of 200 lbs (90.7 kg). The combined weight of a companion appliance should also be considered.
- A grounded electrical outlet located within 2 ft. (61 cm) of either side of the dryer. See **Electrical Requirements(P.24)**.
- No other fuel-burning appliance can be installed in the same closet as a dryer.

Do not operate your dryer at temperatures below 45°F (7°C). At lower temperatures, the dryer might not shut off at the end of an automatic cycle. This can result in longer drying times. The dryer must not be installed or stored in an area where it will be exposed to water and/or weather. Check code requirements. Some codes limit, or do not permit, installation of the dryer in garages, closets, mobile homes or sleeping quarters. Contact your local building inspector.

## Clearances (Space for Using the Dryer.)

If the duct is installed in the wall.

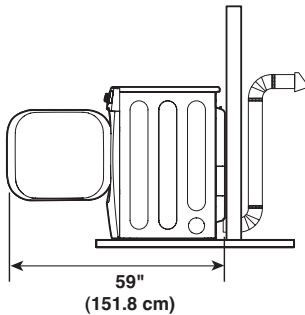

If the duct isn't installed in the wall.

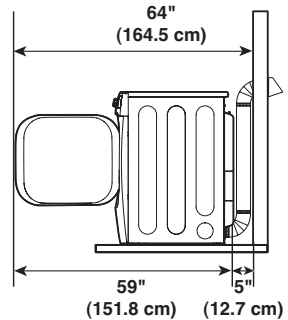

## Installation with optional pedestal base or stacking kit

### RECOMMENDED INSTALLATION SPACING FOR CABINET INSTALLATION

- For cabinet installation with a door, minimum ventilation openings in the top of the cabinet are required.

\*Required spacing

\*\*For side or bottom venting,  
2 inches (5.1 cm) spacing is allowed.

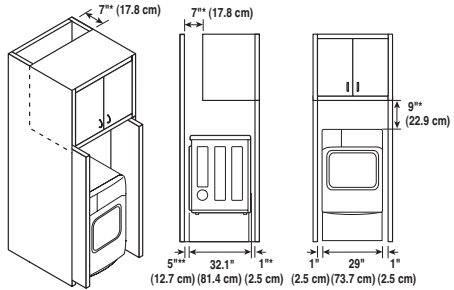

### CLOSET VENTILATION REQUIREMENTS

Closets with doors must have both an upper and lower vent to prevent heat and moisture buildup in the closet. One upper vent opening with a minimum opening of 48 sq. in. (310 cm<sup>2</sup>) must be installed no lower than 6 feet above the floor. One lower vent opening with a minimum opening of 24 sq. in. (155 cm<sup>2</sup>) must be installed no more than one foot above the floor. One example shown uses vent grilles in the door.

### RECOMMENDED INSTALLATION SPACING FOR RECESSED OR CLOSET INSTALLATION, WITH STACKED WASHER AND DRYER

- The dimensions shown are for the recommended spacing.

\*Required spacing

\*\*For side or bottom venting,  
2 inches (5.1 cm) spacing is allowed.

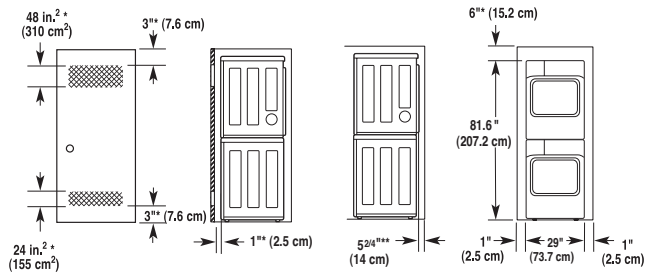

## Leveling the dryer

### ⚠ WARNING

- **To reduce the risk of injury to persons, adhere to all industry recommended safety procedures including the use of long sleeved gloves and safety glasses.**

Failure to follow this warning can cause serious injury or death.

- **The appliances are heavy. Two or more people are required when installing the dryer.** Failure to follow this warning can cause serious injury or death.

To ensure that the dryer provides optimal drying performance, it must be level. To minimize vibration, noise, and unwanted movement, the floor must be a perfectly level, solid surface.

### ! NOTE

Adjust the leveling feet only as far as necessary to level the dryer. Extending the leveling feet more than necessary can cause the dryer to vibrate.

1. Position the dryer in the final location. Place a level across the top of the dryer.

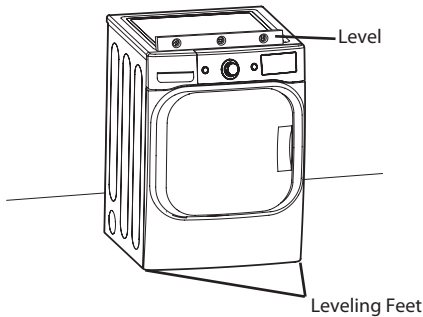

- All four leveling feet must rest solidly on the floor. Gently push on the top corners of the dryer to make sure that the dryer does not rock from corner to corner.

If you are installing the dryer on the optional pedestal, you must use the leveling feet on the pedestal to level the dryer. The dryer leveling feet should be fully retracted.

2. Use an adjustable wrench to turn the leveling feet. Turn clockwise to raise the dryer or counterclockwise to lower it. Raise or lower the leveling feet until dryer is level from side to side and front to back.

Make sure that all 4 leveling feet are in firm contact with the floor.

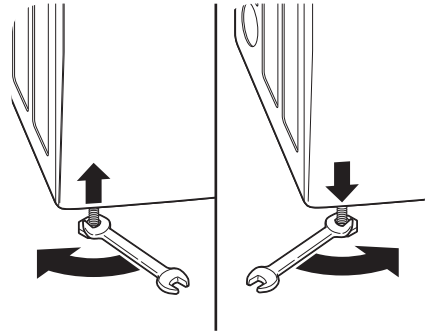

## To remove the door

### ⚠ WARNING

- To avoid damage to the dryer or the door, support the door with a stool or box that fits under the door, or have an assistant support the weight of the door.
- Always reverse the door BEFORE stacking the dryer on top of the washer.
- Avoid dropping the door to avoid damage to the door or the floor.

THE DRYER DOOR IS VERY LARGE AND HEAVY. Failure to follow the instructions below can result in damage to the dryer, property damage or injury to persons.

1. Open the door to reverse.

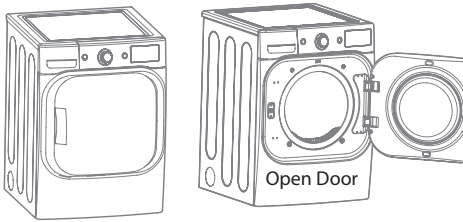

2. Check screws to remove (Left 6, Right 4).

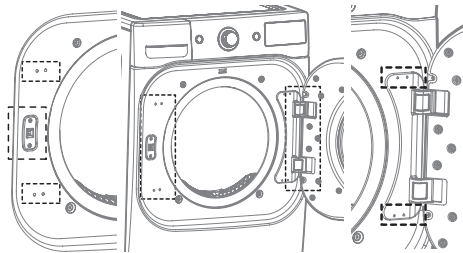

3. Remove four dummy screws by driver.

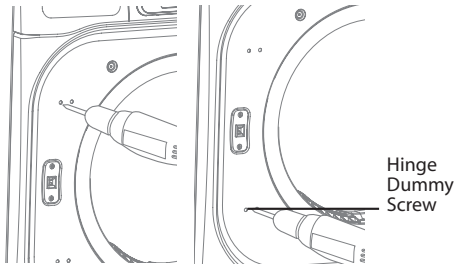

4. Remove two screws and disassembly Latch.

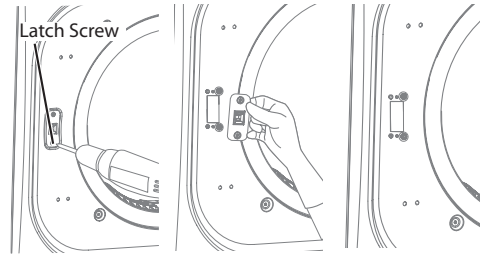

5. Hold on the hinge while remove 2 screws of hinge (to prevent door dropping).

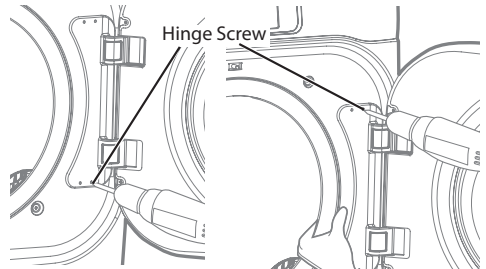

6. Remove door from cabinet cover.

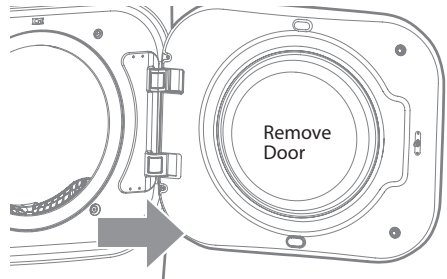

## To install the door

### ⚠ WARNING

- To avoid damage to the dryer or the door, support the door with a stool or box that fits under the door, or have an assistant support the weight of the door.
- Always reverse the door BEFORE stacking the dryer on top of the washer.
- Avoid dropping the door to avoid damage to the door or the floor.

THE DRYER DOOR IS VERY LARGE AND HEAVY. Failure to follow the instructions below can result in damage to the dryer, property damage or injury to persons.

1. Move door to left side and insert a hinge to hinge hole.

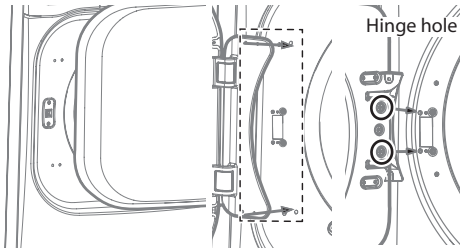

2. Hold on hinge while screw down a hinge (to prevent door dropping).

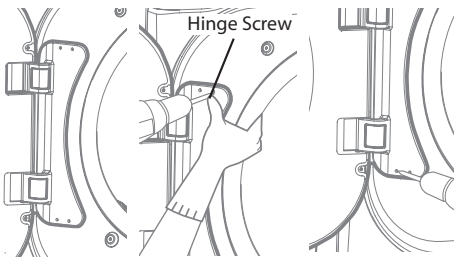

3. Insert latch to right side and install screws.

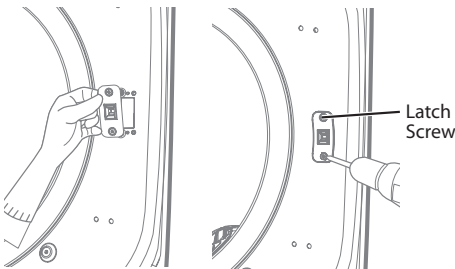

4. Screw down four dummy screws right side.

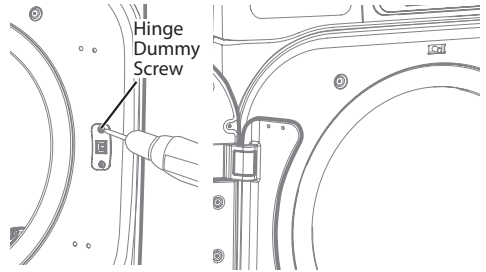

5. Check that the door closes and latches properly.

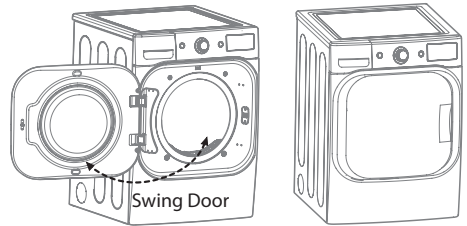

## Installing the Side Vent Kit

### **⚠️ WARNING**

- Use a heavy metal vent.
- Do not use plastic or thin foil duct.
- Clean old ducts before installing this dryer.
- To reduce the risk of injury to persons, adhere to all industry recommended safety procedures including the use of long sleeved gloves and safety glasses.
- Failure to follow all of the safety warnings in this manual could result in property damage, injury to persons, or death.

Your new dryer is shipped to vent to the rear. It can also be configured to vent to the bottom or side (right-side venting is not available on gas models).

An adapter kit, part number **383EEL9001B**, may be purchased from your LG retailer. This kit contains the necessary duct components to change the dryer vent location.

1. Remove the rear exhaust duct retaining screw. Pull out the exhaust duct.

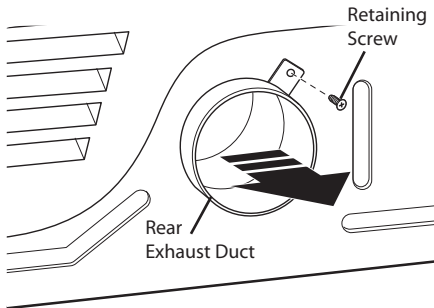

#### **Option 1: Side Venting**

2. Press the tabs on the knockout and carefully remove the knockout for the desired vent opening (right-side venting is not available on gas models). Press the adapter duct onto the blower housing and secure to the base of the dryer as shown.

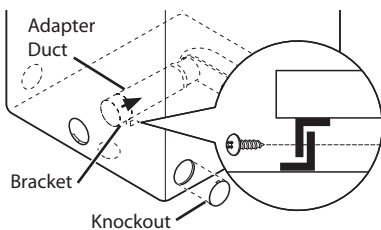

3. Preassemble a 4 inches (10.2 cm) elbow to the next 4-inches (10.2 cm) duct section, and secure all joints with duct tape. Be sure that the male end of the elbow faces AWAY from the dryer. Insert the elbow/duct assembly through the side opening and press it onto the adapter duct. Secure in place with duct tape. Be sure that the male end of the duct protrudes 1½ inches (3.8 cm) to connect the remaining ductwork. Attach cover plate to the back of the dryer with included screw.

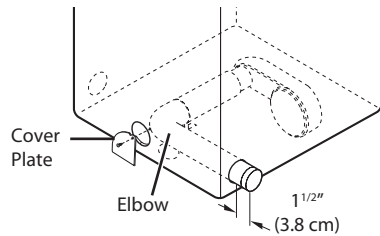

#### **Option 2: Bottom Venting**

2. Press the adapter duct onto the blower housing and secure to the base of the dryer as shown.

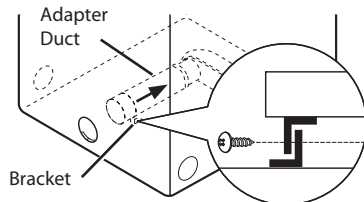

3. Insert the 4 inches (10.2 cm) elbow through the rear opening and press it onto the adapter duct. Be sure that the male end of the elbow faces down through hole in the bottom of the dryer. Secure in place with duct tape. Attach the cover plate to the back of the dryer with included screw.

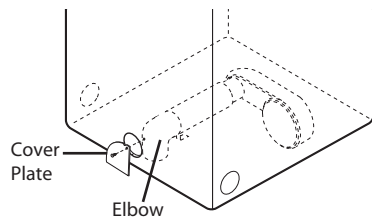



## Venting the Dryer

### WARNING

To reduce the risk of fire, electric shock, or injury to persons when using this appliance, follow basic precautions, including the following:

- **Do not crush or collapse ductwork.** Failure to follow these instructions can result in fire or death.
- **Do not allow ductwork to rest on or contact sharp objects.** Failure to follow these instructions can result in fire or death.
- **If connecting to existing ductwork, make sure it is suitable and clean before installing the dryer.** Failure to follow these instructions can result in fire or death.
- **Venting must conform to local building codes.** Failure to follow these instructions can result in fire or death.
- **Gas dryers MUST exhaust to the outdoors.** Failure to follow these instructions can result in fire or death.
- **Use only 4-inch (10.2 cm) rigid or flexible metal ductwork inside the dryer cabinet and for venting outside.** Failure to follow these instructions can result in fire or death.
- **To reduce the risk of fire, combustion, or accumulation of combustible gases, DO NOT exhaust dryer air into an enclosed and unventilated area, such as an attic, wall, ceiling, crawl space, chimney, gas vent, or concealed space of a building.** Failure to follow these instructions can result in fire or death.
- **To reduce the risk of fire, DO NOT exhaust the dryer with plastic or thin foil ducting.** Failure to follow these instructions can result in fire or death.
- **The exhaust duct must be 4 inches (10.2 cm) in diameter with no obstructions. The exhaust duct should be kept as short as possible. Make sure to clean any old ducts before installing your new dryer.** Failure to follow these instructions can result in fire or death.
- **Rigid or semirigid metal ducting is recommended for use between the dryer and the wall. In special installations when it is impossible to make a connection with the above recommendations, a UL-listed flexible metal transition duct may be used between the dryer and wall connection only. The use of this ducting will affect drying time.** Failure to follow these instructions can result in fire or death.
- **DO NOT use sheet metal screws or other fasteners which extend into the duct that could catch lint and reduce the efficiency of the exhaust system. Secure all joints with duct tape.** Failure to follow these instructions can result in fire or death.
- **To maximize operating results, please observe the duct length limitations noted in the chart next page.** Failure to follow these instructions can result in fire or death.
- **Ductwork is not provided with the dryer. You should obtain the necessary ductwork locally. The end cap should have hinged dampers to prevent backdraft when the dryer is not in use.** Failure to follow these instructions can result in fire or death.
- **The total length of flexible metal duct shall not exceed 8 ft. (2.4 m)**
- **In Canada, that only those foil-type flexible ducts, if any, specifically identified for use with the appliance by the manufacturer shall be used.** In the United States, that only those foil-type flexible ducts, if any, specifically identified for use with the appliance by the manufacturer and that comply with the Outline for Clothes Dryer Transition Duct, Subject 2158A, shall be used.

## Venting the Dryer (cont.)

### Ductwork

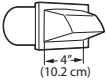
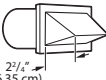
Wall Cap Type	Number Of 90° Elbows	Maximum Length Of 4-inch Diameter Rigid Metal Duct
 	0	65 ft. (19.8 m)
	1	55 ft. (16.8 m)
	2	47 ft. (14.3 m)
	3	36 ft. (11.0 m)
	4	28 ft. (8.5 m)
Use only for short run installations 	0	55 ft. (16.8 m)
	1	47 ft. (14.3 m)
	2	41 ft. (12.5 m)
	3	30 ft. (9.1 m)
	4	22 ft. (6.7 m)

### Correct Venting

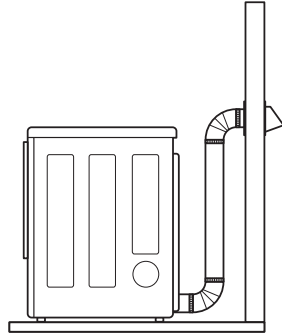

### Incorrect Venting

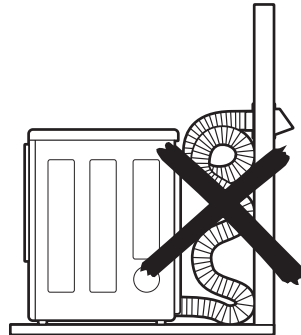

#### NOTE

Deduct 6 ft. (1.8 m) for each additional elbow. It is not recommended to use more than four 90° elbows.

### Routing and Connecting Ductwork

#### NOTE

Follow the guidelines below to maximize drying performance and reduce lint buildup and condensation in the ductwork. Ductwork and fittings are NOT included and must be purchased separately.

- Use 4-inch (10.2 cm) diameter rigid or semirigid metal ductwork.
- The exhaust duct run should be as short as possible.
- Use as few elbow joints as possible.
- The male end of each section of exhaust duct must point away from the dryer.
- Use duct tape on all duct joints.
- Insulate ductwork that runs through unheated areas in order to reduce condensation and lint buildup on duct surfaces.
- Incorrect or inadequate exhaust systems are not covered by the dryer warranty. Failures or poor performance caused by such exhaust systems will not be covered by the dryer warranty.

## Connecting Gas Dryers

### WARNING

To reduce the risk of fire, electric shock, or injury to persons when using this appliance, follow basic precautions, including the following:

- **Gas supply requirements:**  
As shipped from the factory, this dryer is configured for use with natural gas. It can be converted for use with LP (Liquefied Propane) gas. Gas pressure must not exceed 13 inches of water column.
- **A qualified service or gas company technician must connect the dryer to the gas service.**  
Failure to do so can result in fire, explosion, or death.
- **Isolate the dryer from the gas supply system by closing its individual manual shutoff valve during any pressure testing of the gas supply.** Failure to do so can result in fire, explosion, or death.
- **Supply line requirements:**  
Your laundry room must have a rigid gas supply line to your dryer. In the United States, an individual manual shutoff valve **MUST** be installed within at least 6 ft. (1.8 m) of the dryer, in accordance with the National Fuel Gas Code ANSI Z223.1 or Canadian gas installation code CSA B149.1. A  $\frac{1}{8}$  - inch NPT pipe plug must be installed. Failure to do so can result in fire, explosion, death.
- **If using a rigid pipe, the rigid pipe should be  $\frac{1}{2}$  - inch IPS. If acceptable under local codes and ordinances and when acceptable to your gas supplier,  $\frac{3}{8}$  - inch approved tubing may be used where lengths are less than 20 ft. (6.1 m). Larger tubing should be used for lengths in excess of 20 ft. (6.1 m). Failure to do so can result in fire, explosion, or death.**
- **Connect the dryer to the type of gas shown on the nameplate.** Failure to do so can result in fire, explosion, or death.
- **To prevent contamination of the gas valve, purge the gas supply of air and sediment before connecting the gas supply to the dryer. Before tightening the connection between the gas supply and the dryer, purge remaining air until the odor of gas is detected.** Failure to do so can result in fire, explosion, or death.
- **DO NOT use an open flame to inspect for gas leaks. Use a noncorrosive leak-detection fluid.** Failure to do so can result in fire, explosion, or death.
- **Use only a new AGA- or CSA-certified gas supply line with flexible stainless steel connectors.** Failure to do so can result in fire, explosion, or death.
- **Securely tighten all gas connections.** Failure to do so can result in fire, explosion, or death.
- **DO NOT attempt any disassembly of the dryer; any disassembly requires the attention and tools of an authorized and qualified service person or company.** Failure to do so can result in fire, explosion, or death.
- **Use a pipe-joint compound that is insoluble in Liquefied Petroleum (LP) gas on all pipe threads.** Failure to do so can result in fire, explosion, or death.

#### *Electrical requirements for gas models only*

### WARNING

To reduce the risk of fire, electric shock, or injury to persons when using this appliance, follow basic precautions, including the following:

- **Do not, under any circumstances, cut or remove the third (ground) prong from the power cord.** Failure to follow this warning can result in fire, explosion, or death.
- **For personal safety, this dryer must be properly grounded.** Failure to follow this warning can result in fire, explosion, or death.
- **The power cord of this dryer is equipped with a 3-prong (grounding) plug which mates with a standard 3-prong (grounding) wall outlet to minimize the possibility of electric shock hazard from this appliance.** Failure to follow this warning can result in fire, explosion, or death.
- **This dryer must be plugged into a 60 Hz, 120 VAC, grounded outlet protected by a 15-ampere fuse or circuit breaker.** Failure to follow this warning can result in fire, explosion, or death.
- **Where a standard 2-prong wall outlet is encountered, it is your personal responsibility and obligation to have it replaced with a properly grounded 3-prong wall outlet.** Failure to follow this warning can result in fire, explosion, or death.

## Connecting Gas Dryers (cont.)

### ⚠️ WARNING

To reduce the risk of fire, electric shock, or injury to persons when using this appliance, follow basic precautions, including the following:

- **Installation and service must be performed by a qualified installer, service agency, or the gas supplier.** Failure to do so can result in fire, explosion, or death.
- **Use only a new stainless steel flexible connector and a new AGA-certified connector.** Failure to do so can result in fire, explosion, or death.
- **A gas shutoff valve must be installed within 6 ft. (1.8 m) of the dryer.** Failure to do so can result in fire, explosion, or death.
- **The dryer is configured for Natural Gas when shipped from the factory. Make sure that the dryer is equipped with the correct burner orifice for the type of gas being used (Natural Gas or Liquefied Petroleum).** Failure to do so can result in fire, explosion, or death.
- **If necessary, the correct orifice (For the LP orifice kit, order part number 383EEL3002D) should be installed by a qualified technician and the change should be noted on the dryer.** Failure to do so can result in fire, explosion, or death.
- **All connections must be in accordance with local codes and regulations.** Failure to do so can result in fire, explosion, or death.
- **Gas dryers MUST exhaust to the outdoors.** Failure to do so can result in fire, explosion, or death.

### Connecting the gas supply

1. Make sure that the gas supply to the laundry room is turned OFF. Confirm that the type of gas available in your laundry room is appropriate for the dryer. The dryer is prepared for Natural Gas with a  $\frac{3}{8}$ -inch NPT gas connection.
2. Remove the shipping cap from the gas connection at the back of the dryer. Be careful not to damage the threads of the gas connector when removing the shipping cap.
3. Connect the dryer to your laundry room's gas supply using a new flexible stainless steel connector with a  $\frac{3}{8}$ -inch NPT fitting.
4. Securely tighten all connections between the dryer and your laundry room's gas supply. Turn on your laundry room's gas supply and check all pipe connections (both internal and external) for gas leaks with a noncorrosive leak-detection fluid.

### Electrical connection

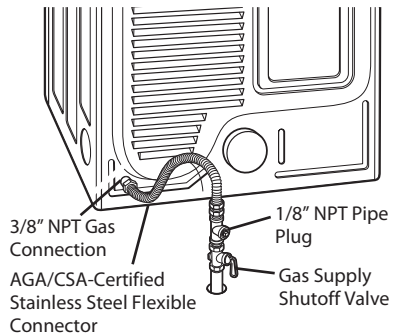
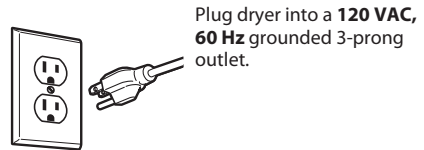

### High-altitude installations

The BTU rating of this dryer is AGA-certified for elevations below 10,000 feet.

If your gas dryer is being installed at an elevation above 10,000 feet, it must be derated by a qualified technician or gas supplier.

## Connecting Electric Dryers

### WARNING

To help prevent fire, electric shock, serious injury, or death, the wiring and grounding must conform to the latest edition of the National Electrical Code, ANSI/NFPA 70 and all applicable local regulations. Please contact a qualified electrician to check your home's wiring and fuses to ensure that your home has adequate electrical power to operate the dryer.

#### *Electrical requirements for electric models only*

### WARNING

To reduce the risk of fire, electric shock, or injury to persons when using this appliance, follow basic precautions, including the following:

- **This dryer must be connected to a grounded metal, permanent wiring system, or an equipment-grounding conductor must be run with the circuit conductors and connected to the equipment-grounding terminal or lead on the dryer.** Failure to do so can result in fire, explosion, or death.
- **The dryer has its own terminal block that must be connected to a separate 240 VAC, 60-Hertz, single-phase circuit, fused at 30 amperes (the circuit must be fused on both sides of the line). ELECTRICAL SERVICE FOR THE DRYER SHOULD BE OF THE MAXIMUM RATE VOLTAGE LISTED ON THE NAMEPLATE. DO NOT CONNECT DRYER TO 110-, 115-, OR 120-VOLT CIRCUIT.** Failure to follow these instructions can result in fire, explosion, or death.
- **If branch circuit to dryer is 15 ft. (4.5 m) or less in length, use UL (Underwriters Laboratories) listed No.-10 AWG wire (copper wire only), or as required by local codes. If over 15 ft. (4.5 m), use UL-listed No.-8 AWG wire (copper wire only), or as required by local codes. Allow sufficient slack in wiring so dryer can be moved from its normal location when necessary.** Failure to do so can result in fire, explosion, or death.
- **The power cord (pigtail) connection between wall receptacle and dryer terminal block IS NOT supplied with dryer. Type of pigtail and gauge of wire must conform to local codes and with instructions on the following pages.** Failure to follow these instructions can result in fire, explosion, or death.
- **A 4-wire connection is required for all mobile and manufactured home installations, as well as all new construction after January 1, 1996. A 4-wire connection must be used where local codes do not permit grounding through the neutral wire.** Failure to do so can result in fire, explosion, or death.

### WARNING

To reduce the risk of fire, electric shock, or injury to persons when using this appliance, follow basic precautions, including the following:

- **Do not modify the plug and internal wire provided with the dryer.**
- **The dryer should be connected to 4-hole outlet.**
- **If it does not fit the outlet, a proper outlet will need to be installed by a qualified electrician.**

### WARNING

To reduce the risk of fire, electric shock, or injury to persons when using this appliance, follow basic precautions, including the following:

- **Any installation in a manufactured or mobile home must comply with the Manufactured Home Construction and Safety Standards Title 24 CFR, Part 3280 or Standard CAN/ CSA Z240 MH and local codes and ordinances.**
- **A 4-wire connection is required for all mobile and manufactured home installations, as well as all new construction after January 1, 1996.** Failure to do so can result in fire, explosion, or death.

## Connecting Electric Dryers (cont.) USA only

### **⚠️ WARNING**

• Connect the power cord to the terminal block. Connect each power cord wire to the terminal block screw that has the same colored wire. For example, connect the black power cord wire to the terminal block screw with the black wire. Failure to follow these instructions may result in a short, overload, fire or death.

• Grounding through the neutral conductor is prohibited for: (1) new branch-circuit installations, (2) mobile homes, (3) recreational vehicles, and (4) areas where local codes prohibit grounding through the neutral conductor.



**Four-wire connection for electric dryers:  
Power cord**

- A 4-wire connection is required for all mobile and manufactured home installations, as well as all new construction after January 1, 1996.
- A UL-listed strain relief is required.

1. Remove the terminal block access cover on the upper back of the dryer. Install a UL-listed strain relief into the power cord through-hole; then thread a UL-listed, **30 A, 240 V, 4-wire, #10 AWG-minimum copper** conductor power cord through the strain relief.

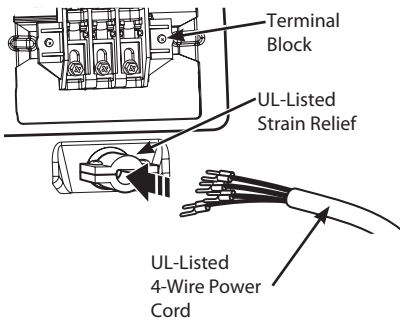

- Use a **30 A, 240 V, UL-listed power cord with #10 AWG-minimum copper** conductor and closed loop or forked terminals with upturned ends.
2. Transfer the dryer's ground wire from behind the green ground screw to the center screw of the terminal block. Attach the two hot leads of the power cord to the outer terminal block screws. Attach the white neutral wire to the center terminal block screw. Attach the power cord ground wire to the green ground screw. **TIGHTEN ALL SCREWS SECURELY.** Reinstall the terminal block access cover.

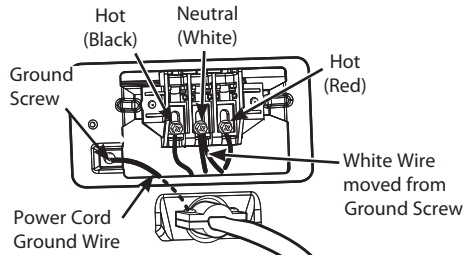

## Connecting Electric Dryers (cont.)

### USA only

#### **⚠️ WARNING**

• **Connect the power cord to the terminal block. Connect each power cord wire to the terminal block screw that has the same colored wire. For example, connect the black power cord wire to the terminal block screw with the black wire.**

**Failure to follow these instructions may result in a short, overload, fire or death.**

• **Grounding through the neutral conductor is prohibited for: (1) new branch-circuit installations, (2) mobile homes, (3) recreational vehicles, and (4) areas where local codes prohibit grounding through the neutral conductor.**

#### **Four-wire connection for electric dryers: Direct wire**

• A 4-wire connection is required for all mobile and manufactured home installations, as well as all new construction after January 1, 1996.

• A UL-listed strain relief is required.

1. Remove 5 inches (12.7 cm) of the outer covering from the wire. Remove 5 inches of insulation from the ground wire. Cut off approximately 1½ inches (3.8 cm) from the other three wires and strip 1 inch (2.5 cm) insulation from each wire. Bend the ends of the three shorter wires into a hook shape.

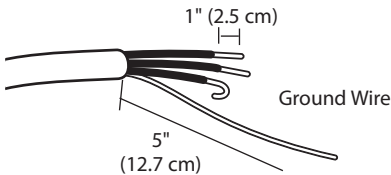

2. Remove the terminal block access cover on the upper back of the dryer. Install a UL-listed strain relief into the power cord through-hole; then thread the power cable prepared in Step 1 through the strain relief.

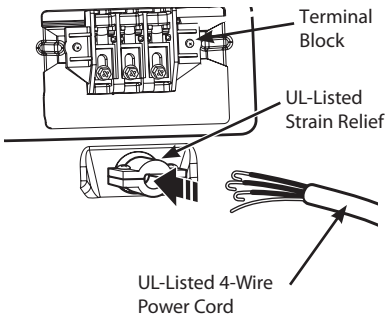

- Use UL-listed **4-wire #10 AWG-minimum copper** conductor cable.
  - Allow at least 5 ft. (1.5 m) length to allow for removal and reinstallation of the dryer.
3. Transfer the dryer's ground wire from behind the green ground screw to the center screw of the terminal block. Attach the two hot leads of the power cable to the outer terminal block screws. Attach the white neutral wire to the center terminal block screw. Attach the power cable ground wire to the green ground screw. **TIGHTEN ALL SCREWS SECURELY.** Reinstall the terminal block access cover.

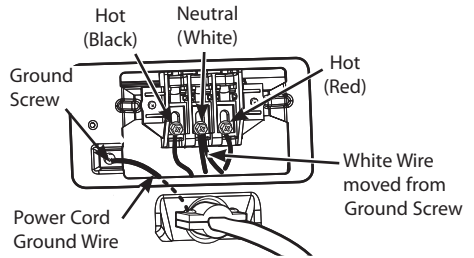

## Connecting Electric Dryers (cont.)

### USA only

#### **⚠ WARNING**

• Connect the power cord to the terminal block. Connect each power cord wire to the terminal block screw that has the same colored wire. For example, connect the black power cord wire to the terminal block screw with the black wire. Failure to follow these instructions may result in a short, overload, fire or death.

• Grounding through the neutral conductor is prohibited for: (1) new branch-circuit installations, (2) mobile homes, (3) recreational vehicles, and (4) areas where local codes prohibit grounding through the neutral conductor.



**Three-wire connection for electric dryers: Power cord**

- A 3-wire connection is NOT permitted on new construction after January 1, 1996.
- A UL-listed strain relief is required.

1. Remove the terminal block access cover on the upper back of the dryer. Install a UL-listed strain relief into the power cord through-hole; then thread a UL-listed, **30 A, 240 V, 3-wire, #10 AWG-minimum copper** conductor power cord through the strain relief.

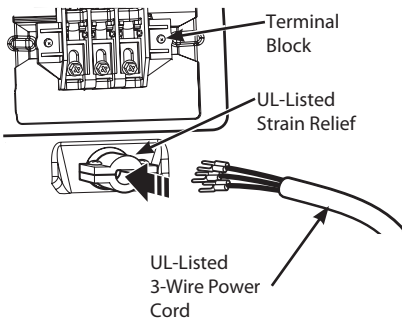

• Use a **30 A, 240 V, UL-listed power cord with #10 AWG-minimum copper** conductor and closed loop or forked terminals with upturned ends.

2. Attach the two hot leads of the power cord to the outer terminal block screws. Attach the neutral wire to the center terminal block screw. Connect the external ground (if required by local codes) to the green ground screw. **TIGHTEN ALL SCREWS SECURELY.** Reinstall the terminal block access cover.

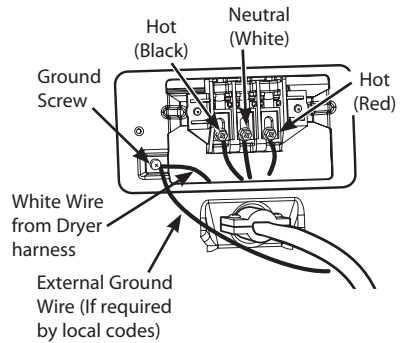



## Connecting Electric Dryers (cont.)

### USA only

#### **⚠️ WARNING**

• **Connect the power cord to the terminal block. Connect each power cord wire to the terminal block screw that has the same colored wire. For example, connect the black power cord wire to the terminal block screw with the black wire. Failure to follow these instructions may result in a short, overload, fire or death.**

• **Grounding through the neutral conductor is prohibited for: (1) new branch-circuit installations, (2) mobile homes, (3) recreational vehicles, and (4) areas where local codes prohibit grounding through the neutral conductor.**

#### **Three-wire connection for electric dryers: Direct wire**

- A 3-wire connection is NOT permitted on new construction after January 1, 1996.
  - A UL-listed strain relief is required.
1. Remove 3½ inches (8.9 cm) of the outer covering from the wire. Strip 1 inch (2.5 cm) insulation from each wire. Bend the ends of the three wires into a hook shape.

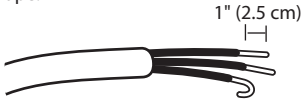

2. Remove the terminal block access cover on the upper back of the dryer. Install a UL-listed strain relief into the power cord through-hole; then thread the power cable prepared in Step 1 through the strain relief.

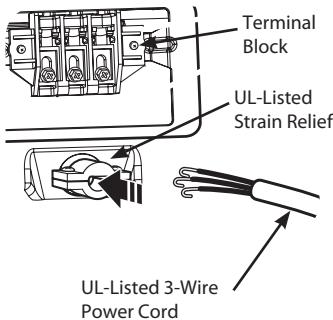

- Use UL-listed **3-wire #10 AWG-minimum copper** conductor cable.
  - Allow at least 5 ft. (1.5 m) length to allow for removal and reinstallation of the dryer.
3. Attach the two hot leads of the power cord to the outer terminal block screws. Attach the neutral wire to the center terminal block screw. Connect the external ground (if required by local codes) to the green ground screw. **TIGHTEN ALL SCREWS SECURELY.** Reinstall the terminal block access cover.

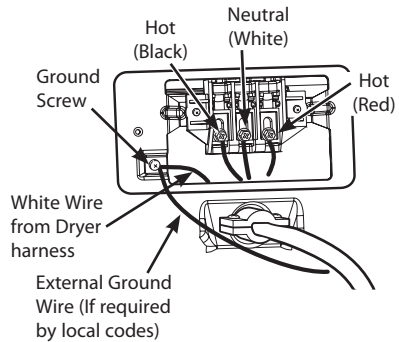

## Special Requirements for Manufactured or Mobile Homes

Any installation in a manufactured or mobile home must comply with the Manufactured Home Construction and Safety Standards Title 24 CFR, Part 3280 or Standard CAN/CSA Z240 MH and local codes and ordinances. If you are uncertain whether your proposed installation will comply with these standards, please contact a service and installation professional for assistance.

- A gas dryer must be permanently attached to the floor.
- The electrical connection for an electric dryer must be a 4-wire connection. More detailed information concerning the electrical connection is provided in the section Connecting Electric Dryers.
- To reduce the risk of combustion and fire, the dryer must be vented to the outside.
- DO NOT vent the dryer under a manufactured home or mobile home.
- Electric dryers may be vented to the outside using the back, left, right, or bottom panel.
- Gas dryers may be vented to the outside using the back, left, or bottom panel. Gas dryers may not be vented to the outside using the right side panel because of the burner housing.
- The dryer exhaust duct must be affixed securely to the manufactured or mobile home structure, and the exhaust duct must be made of a material that will resist fire and combustion. It is recommended that you use a rigid or flexible metal duct.
- DO NOT connect the dryer exhaust duct to any other duct, vent, chimney, or other exhaust duct.
- Make sure the dryer has adequate access to outside fresh air to ensure proper operation. The opening for outside fresh air must be at least 25 in<sup>2</sup> (163 cm<sup>2</sup>).
- It is important that the clearance of the duct from any combustible construction be at least 2 inches (5 cm), and when venting the dryer to the outdoors, the dryer can be installed with a clearance of 1 inch (2.5 cm) at the sides and back of the dryer.
- Please be aware that venting materials are not supplied with the dryer. You should obtain the venting materials necessary for proper installation.

## Final Installation Check

Once you have completed the installation of the dryer and it is in its final location, confirm proper operation with the following tests and Installation Test (Duct Check) on the following page.

### Testing dryer heating

#### GAS MODELS

Close the dryer door, press the On/Off button to turn the dryer on, and start the dryer on a heat setting. When the dryer starts, the igniter should ignite the main burner.

#### NOTE

If all air is not purged from the gas line, the gas igniter may turn off before the main burner ignites. If this happens, the igniter will reattempt gas ignition after approximately two minutes.

#### ELECTRIC MODELS

Close the dryer door, press the On/Off button to turn the dryer on, and start the dryer on a heat setting. The exhaust air should be warm after the dryer has been operating for 3 minutes.

#### Checking airflow

Effective dryer operation requires proper airflow. The adequacy of the airflow can be measured by evaluating the static pressure. Static pressure in the exhaust duct can be measured with a manometer, placed on the exhaust duct approximately 2 ft. (60.9 cm) from the dryer. Static pressure in the exhaust duct should not exceed 0.6 inches (1.5 cm). The dryer should be checked while the dryer is running with no load.

#### Checking levelness

Once the dryer is in its final location, recheck the dryer to be sure it is level. Make sure it is level front to back and side to side, and that all 4 leveling feet are firmly on the floor.

## Installation Test (Exhaust check)

Once you have completed the installation of the dryer, use this test to make sure the condition of the exhaust system is adequate for proper operation of the dryer. This test should be performed to alert you to any serious problems in the exhaust system of your home.

- Your dryer features Flow Sense™, an innovative sensing system that automatically detects blockages and restrictions in dryer ductwork. Keeping ductwork clean of lint buildup and free of restrictions allows clothes to dry faster and reduces energy use.

### NOTE

The dryer should be cool before starting this test. If the dryer was warmed up during installation, run the Air Dry cycle for a few minutes to reduce the interior temperature.

### To activate the installation test:

#### 1. Remove the literature, and then close the door.

Do not load anything in the drum for this test, as it may affect the accuracy of the results.

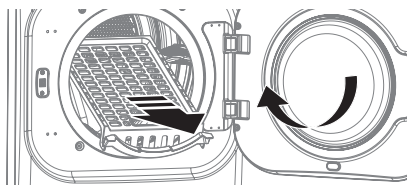

#### 2. Press and hold the Temp. Control and Signal buttons and then press the Power button.

This button sequence activates the installation test. The code **1n5** will display if the activation is successful.

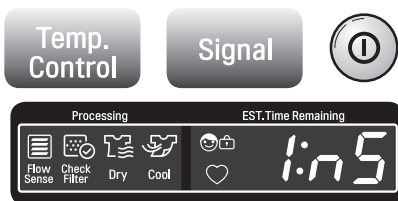

#### 3. Press Start/Pause button.

The dryer will start the test, which will last about two minutes. The heat will be turned on and the temperatures in the drum will be measured.



#### 4. Check the display for results.

During the test cycle, monitor the Flow Sense™ display on the control panel. If no bars are displayed, when the cycle ends, the exhaust system is adequate. If the exhaust system is severely restricted, the display will show four bars. Other problems may also be shown with error codes. Refer to the next page for error code details and solutions.



No Bars: Ok



Four Bars: Restricted

Four bars indicates that the exhaust system is severely restricted. Have the system checked immediately, as performance will be poor.

#### 5. End of cycle.

At the end of the test cycle, **End** will display. The test cycle will end and the dryer will shut off automatically after a short delay.

