

**OWNER'S MANUAL  
& INSTALLATION  
INSTRUCTIONS**

*Do Not Discard,  
Retain for Future Reference*

**Motorized**  
***EasyShade***<sup>®</sup>

**WARNING:**  
**FAILURE TO FOLLOW THESE  
INSTRUCTIONS COULD RESULT  
IN PERSONAL INJURY!**

For Technical Support visit us at <http://ownerscorner.sunsetter.com>,  
e-mail at [contactus@sunsetter.com](mailto:contactus@sunsetter.com) or call Toll Free 800-670-7071 • Fax 877-224-4944

# Motorized EasyShade®

## Owner's Manual & Installation Instruction

### Motorized EasyShade® Schematic View

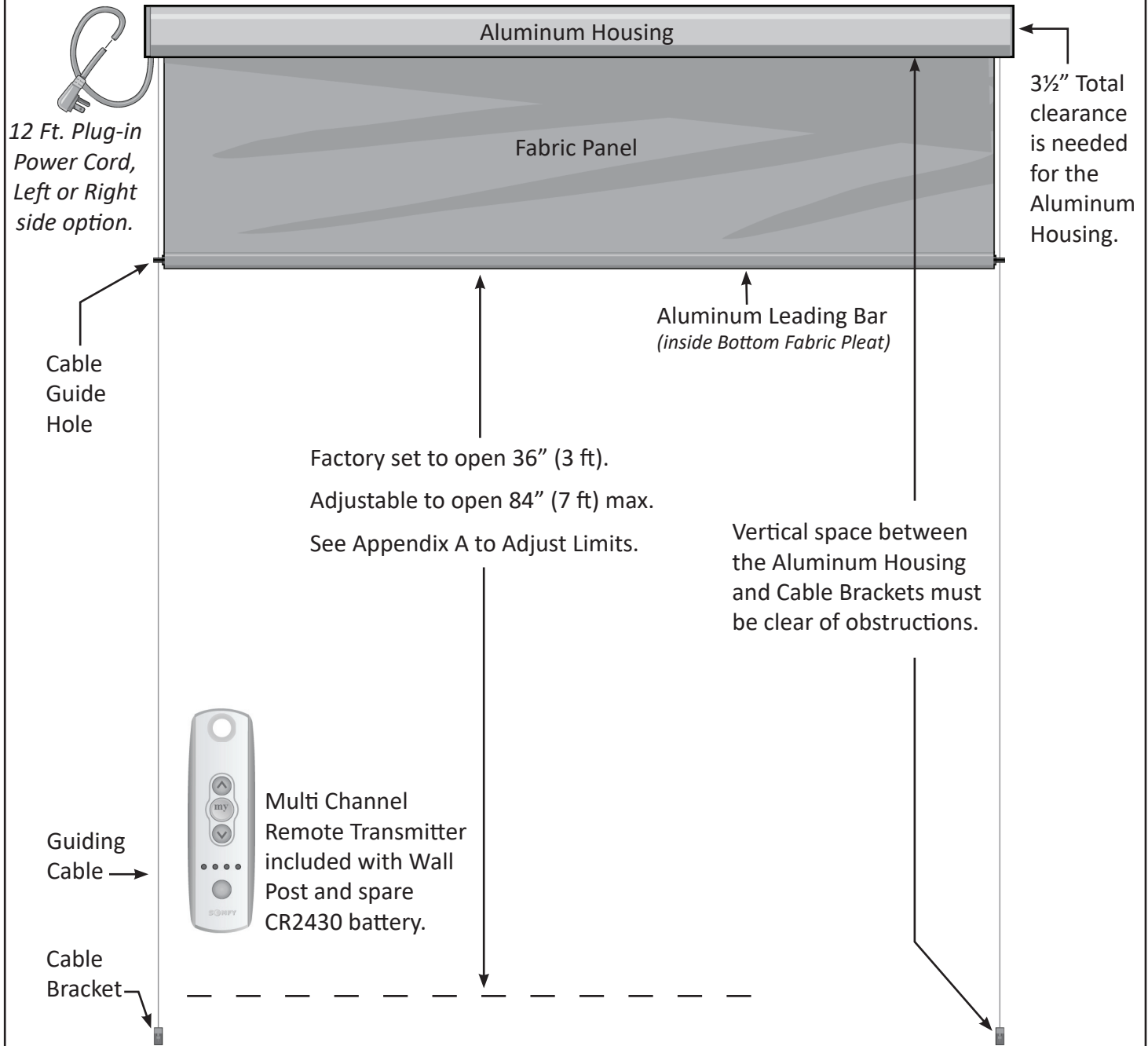

**Note:** The Fabric Panel width is 3" less than the EasyShade width (measured at the Aluminum Housing).

Figure 1

# READ ME FIRST

## Congratulations

You have just purchased a Motorized EasyShade. The EasyShade saves you energy by stopping the glare and the heat before it can enter your home, yet still lets you enjoy your view, all at the touch of a button.

## Customer Support

Our technical experts are available from **8 am - 10 pm EST** daily via email [contactus@sunsetter.com](mailto:contactus@sunsetter.com) or call us at **800-670-7071** should you require assistance. We also invite you to visit the Owner's Corner at <http://ownerscorner.sunsetter.com> for additional information on your Motorized EasyShade. You may need to register your purchase by calling **800-670-7071**. Please be prepared to provide the size (width) of the EasyShade, Motor side (left or right), color of Housing, color of Fabric Panel, and Date of Purchase.

## Factory Limit Settings

The **Up and Down stop limits** on the EasyShade motor were set at the factory to stop 36" from the Housing. This will allow for completion of the installation process, where you will be instructed to adjust the Down Position Limit to a maximum 84".

## Remote Transmitter

EasyShades are programmed to **operate on Channel 1** of the Multi Channel Remote Transmitter provided with the EasyShade. The EasyShade can be operated on any individual channel or multiple channels, and more than one EasyShade can be operated on the same channel. See **Appendix C** for Programming Instructions for the Multi Channel Remote Transmitter.

# TABLE OF CONTENTS

Motorized EasyShade Schematic View (Figure 1) . . . . .	Inside Front Cover
Tools Needed . . . . .	2
Parts Supplied (Figure 2) . . . . .	2
Pre-Installation Note . . . . .	2
Installation . . . . .	3
Vertical Mounting (Figure 3) . . . . .	3
Horizontal Mounting (Figure 4) . . . . .	3
Operating the EasyShade . . . . .	6
Remote Transmitters are unique. . . . .	7
Troubleshooting - Installation . . . . .	8
Troubleshooting - Appearance . . . . .	9
Troubleshooting - Operation . . . . .	9
Troubleshooting - Operation (Additional Motor Troubleshooting) . . . . .	11
Appendix A - Adjusting the Up and Down Position Limits of the EasyShade Motor . . . . .	12
Appendix B - Reset All Communications between the Motor and Remote Transmitter. . . . .	13
Appendix C - Programming Instructions - Multi Channel Remote Transmitter. . . . .	14
5-Year Limited Manufacturer's Warranty . . . . .	15

**\*Helper Needed\***

**Tools Needed:** Electric Drill, 1/8" Drill Bit, Pencil, 3/16" Open End Wrench, Phillips Screwdriver, Tape Measure and Level.

**Parts Supplied:** Motorized EasyShade Assembly, Mounting Brackets, #8 x 1- 1/2" Round-Head Screws, 1/8" Allen Wrench (for Mounting Bracket Set Screws), Two (2) Cable Guide Brackets, Two (2) Cable Guide Stops, 5/64" Allen Wrench (for Cable Guide Stop Set Screws), #8 x 1- 1/2" Flat-Head Screws, and One (1) Multi Channel Remote Transmitter with Wall Mounting Post and Spare CR-2430 Battery.

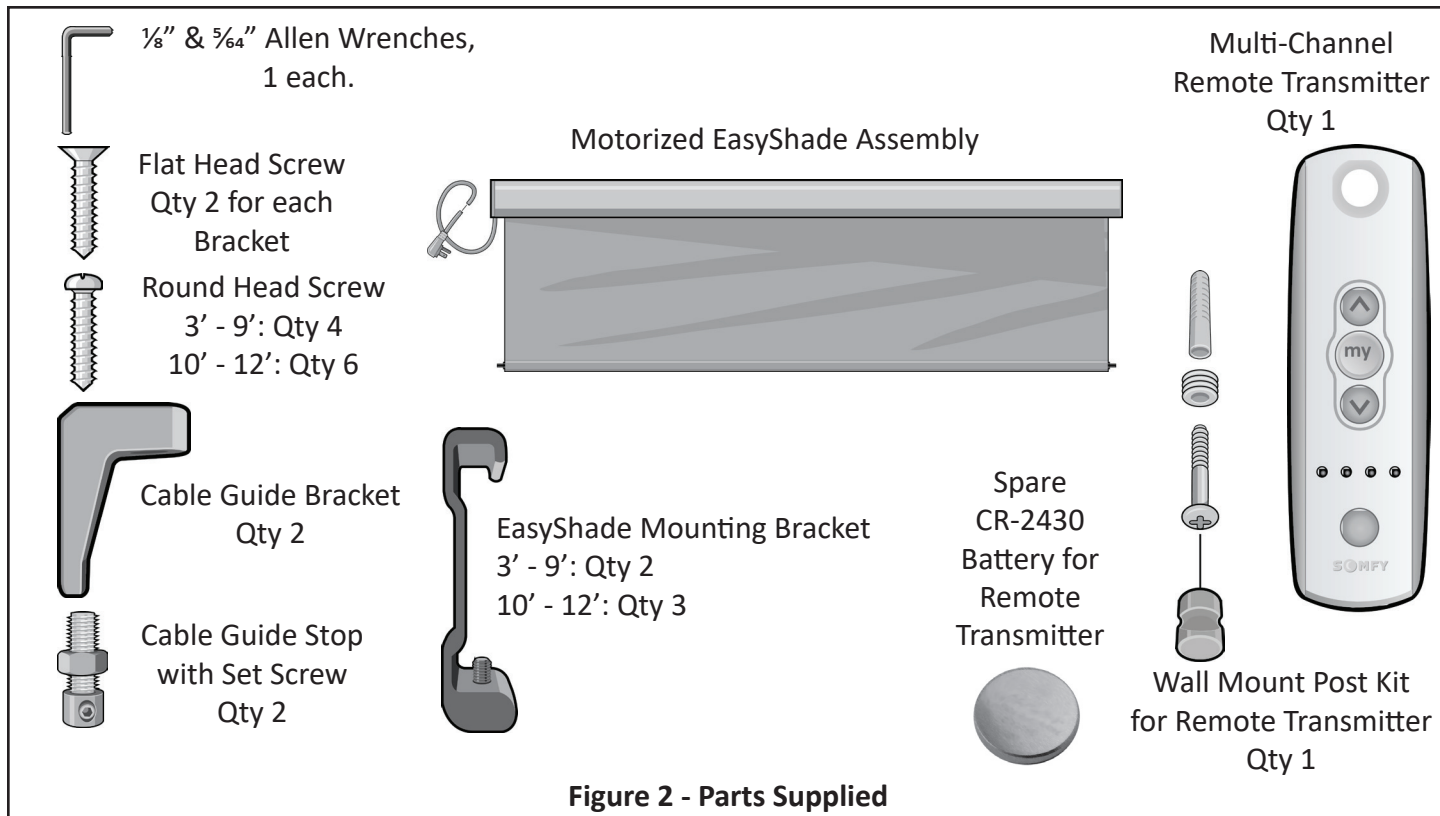

**WARNING: FAILURE TO FOLLOW THESE INSTRUCTIONS CAN RESULT IN PERSONAL INJURY! PLEASE READ THESE INSTRUCTIONS IN ITS ENTIRETY BEFORE ATTEMPTING TO COMPLETE THIS INSTALLATION.**

**PRE-INSTALLATION NOTE**

**Note:** Prior to installing your Motorized EasyShade, please review Figure 1 (Motorized EasyShade Schematic View) then inspect to ensure that there are no obstructions on your wall surface, such as light fixtures or door handles, that would interfere with or block the Fabric Panel as it is extended. For proper operation you must ensure that the Aluminum Housing and Cable Guide Brackets are mounted on the same vertical plane or surface.

The Motorized EasyShade can be installed with the Mounting Brackets on a wall (Vertical Surface, see Figure 3) or on the underside of a structure (Horizontal Surface, see Figure 4). For all models, the two Mounting Brackets should be installed no more than 10" from each end of the Aluminum Housing. For the 10' to 12' models, the third Mounting Bracket should be installed at the mid point between the two End Brackets.

The Aluminum Housing and Mounting Brackets require 3 1/2" of clear, unobstructed space along the mounting surface of the wall or underside of the structure / soffit.

Vertical space between the Aluminum housing and the lower location of the Cable Guide Bracket must be clear of obstructions to allow the Fabric Panel to freely extend.

# INSTALLATION

## MOUNT EASYSHADE® HOUSING TO HOUSE

1. Determine the desired location for the Mounting Brackets, making sure they are plumb and level. Mark the two hole locations with a pencil, for the Bracket. Drill holes with a  $\frac{1}{8}$ " bit, approximately 1- $\frac{1}{2}$ " deep, at both hole locations. Repeat for the Mounting Bracket on the other side, and the center mounting location on 10' to 12' models.

**Note:** Aluminum Housing and Cable Brackets need to be mounted on the same Vertical Surface. If mounted to siding, it may be necessary to shim the Brackets to create a flat mounting surface.

### INSTALL VERTICAL MOUNTING BRACKET

2a. For mounting on a wall (**Vertical Surface**), secure each Bracket with two #8 x 1- $\frac{1}{2}$ " Round Head Screws.

**Note the orientation of the Bracket;** the end with the Set Screw should be at the bottom.

See **Figure 3**.

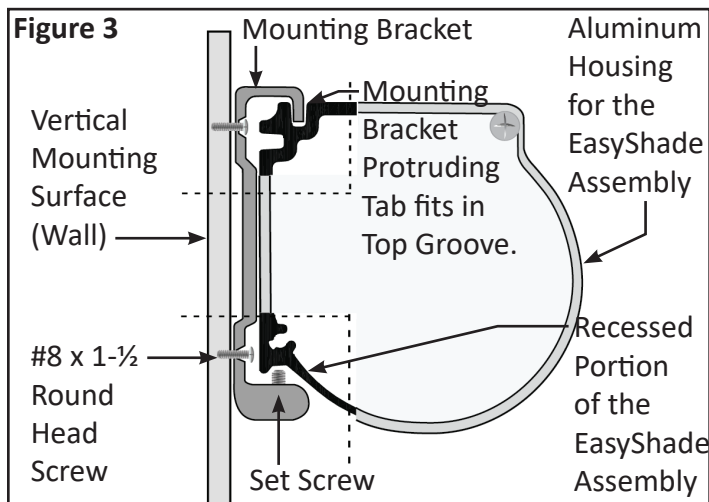

### INSTALL HORIZONTAL MOUNTING BRACKET

2b. For mounting on an underside structure or soffit (**Horizontal Surface**), secure each Bracket with two (2) #8 x 1- $\frac{1}{2}$ " Round Head Screws. **Note the orientation**

**of the Bracket;** the end with the Set Screw should face toward you as you face your Mounting Location.

See **Figure 4**.

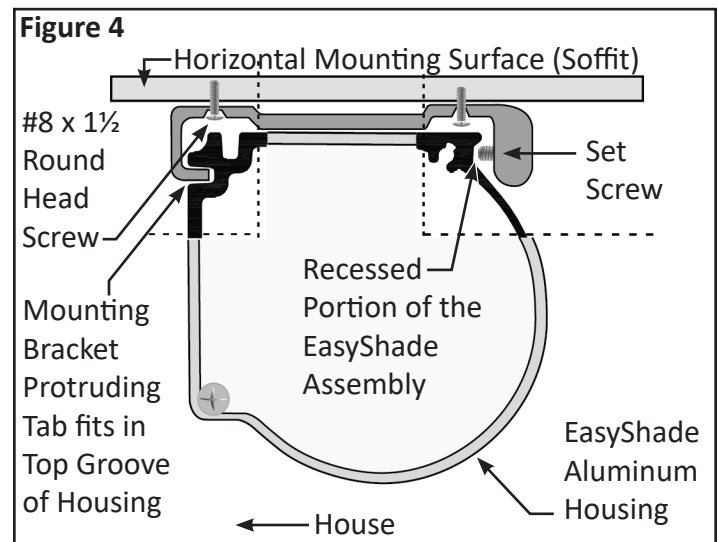

### INSTALL EASYSHADE® INTO BRACKETS

3. With your helper, lift the EasyShade Assembly up to the installed Mounting Brackets and insert the Top Groove of the EasyShade Assembly onto the Protruding Tab of the Mounting Brackets (see **Figure 3** and **4**). While maintaining upward pressure to keep the Top Groove of the EasyShade Assembly on the Tab of the Mounting Brackets, press the EasyShade Assembly toward the Mounting Bracket and be sure the Set Screw is aligned in the Recessed Portion of the EasyShade Assembly. See **Figure 5**.

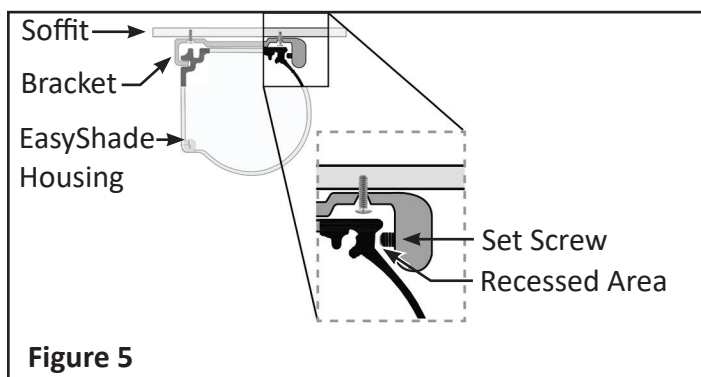

4. Using the 1/8" Allen wrench (supplied), tighten the Set Screw in each Mounting Bracket until the EasyShade Assembly is secure. See **Figure 6**.

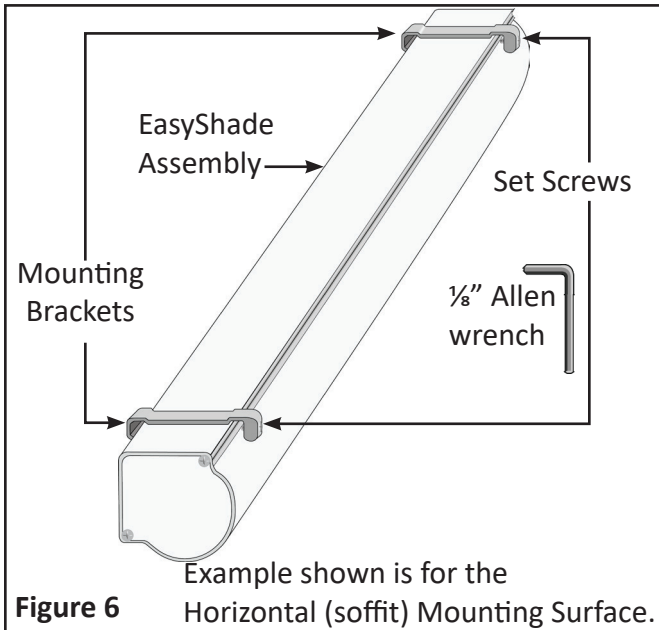

**Note:** The Up and Down Stop Limits on the EasyShade Motor were set at the factory prior to shipment. The Down Stop Limit was set for a 36 inch extension. This will allow for completion of the installation process.

5. Plug the Motorized EasyShade into a GFI electrical outlet.

6. Extend (lower) your EasyShade using the **DOWN** Button on your Remote Transmitter (see **Figure 7**). The Fabric Panel will extend down 36", then stop.

**Note:** If the EasyShade does not respond when you press the **DOWN** Button on the Remote Transmitter, check to see if the first Channel Selector Light on the Remote Transmitter blinks on and off when you press the **DOWN** Button (see **Figure 8**). If one of the other Channel Lights comes on, press the Channel Selector Button until you have switched to the first Channel. See **Figure 8**.

7. Unplug the EasyShade, after the Fabric Panel has been extended to the factory-set 36" position.

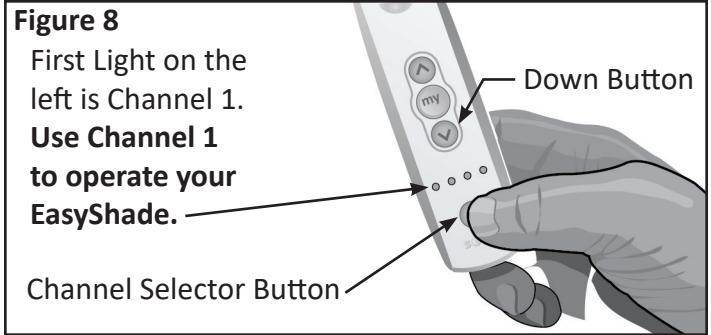
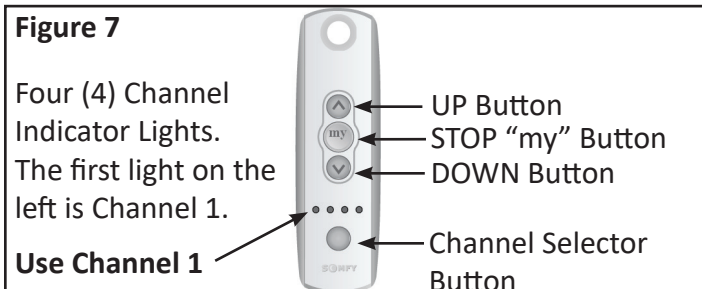

**CAUTION:** The installation procedure for the Motorized EasyShade includes the use of Cable Guides to stabilize the extended Fabric Panel during normal use. If your application does not permit the installation of the necessary Cable Guides or you do not plan to install them, you must use additional care to prevent damage to your product. While we do not recommend installing the Motorized EasyShade without the supplied Cable Guides, some customers may determine that their application does not have a vertical surface to install the supplied Cable Guides as instructed.

8. Unroll the Vinyl Coated Guide Cables located at each end of the Aluminum Housing Assembly, and allow them to hang flat against the Mounting Surface. See **Figure 9**.

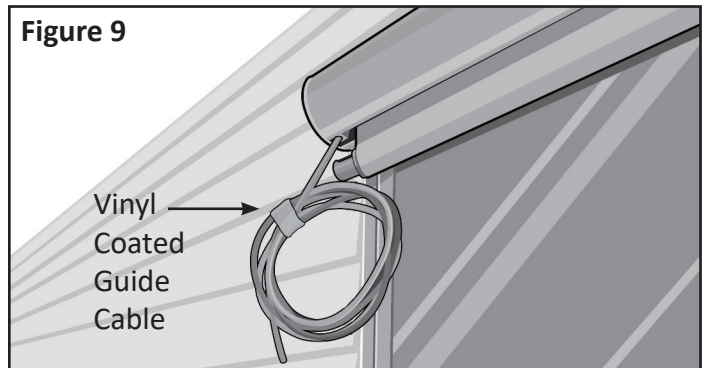

9. Insert the Vinyl Coated Guide Cable, located at each end of the Aluminum Housing Assembly, through the Guide Holes at each end of the Leading Bar, at the bottom of the EasyShade Fabric Panel. See **Figure 10**.

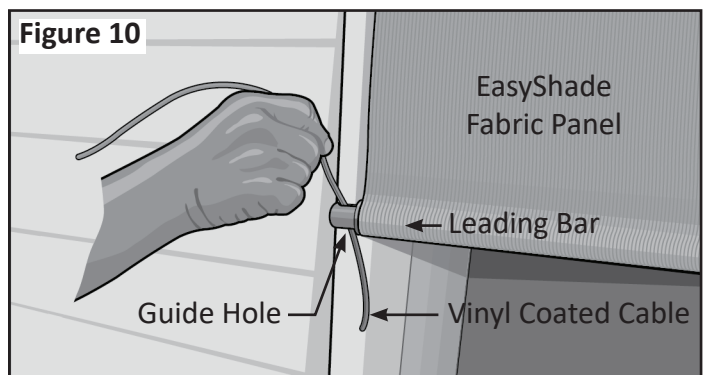



**10.** Determine how far down your EasyShade will be extended (this is limited to the length of the Vinyl Coated Cable, but you can not exceed 84" from the bottom of the EasyShade Housing). Mark a Horizontal Line on the wall below each end of the EasyShade Housing Assembly. See **Figure 11**.

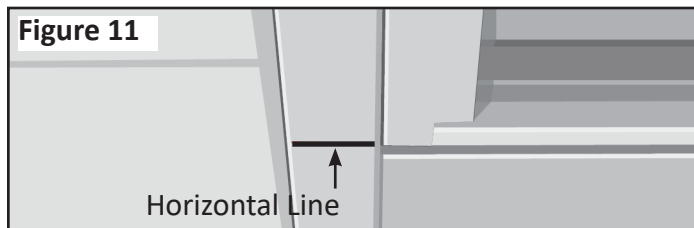

**11.** Using the Vinyl Coated Cable as a guide, ensure (using a level) the Cable is straight and plumb and mark a Vertical Line (see **Figure 12**) where it crosses the Horizontal Line made in **Step 10**. Cable Guide Brackets must be mounted on the same vertical plane as the EasyShade Aluminum Housing.

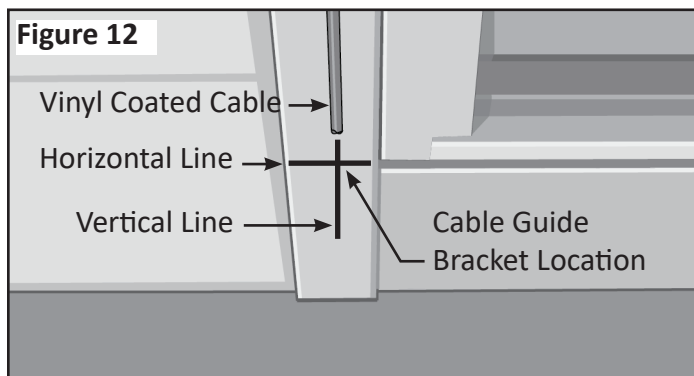

**12.** Locate the Cable Guide Brackets and Cable Guide Stops in your Hardware Package.

**13.** Align the top of the Cable Guide Brackets below the Horizontal Line and centered on the Vertical Lines as shown in **Figure 13**. Ensure the Bracket is plumb and on the same vertical plane as the Aluminum Housing above, then mark both screw hole locations. Remove the Bracket and pre-drill both screw hole locations with a 1/8" drill bit. Repeat for the other side of the EasyShade.

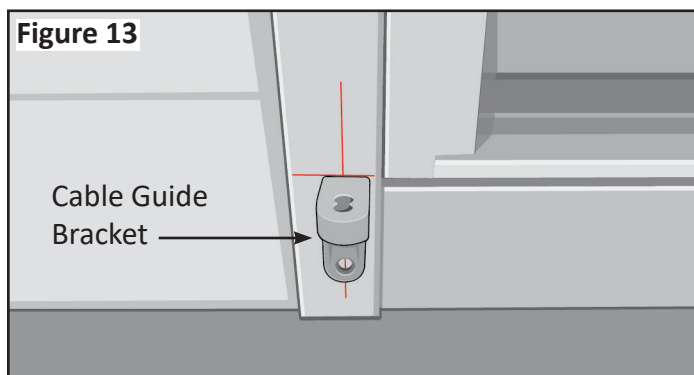

**14.** Place the Cable Guide Bracket over the pre-drilled holes and secure in place with the #8 x 1-1/2 Flat Head Screws.

**15.** Place the lower end of one of the Vinyl Coated Cables through the hole in the Cable Guide Bracket you just installed. From the bottom, slide one of the Cable Guide Stops onto the Vinyl Coated Cable and secure in place with the supplied 5/64" Allen Wrench. Repeat for the other side of the EasyShade. See **Figure 14**.

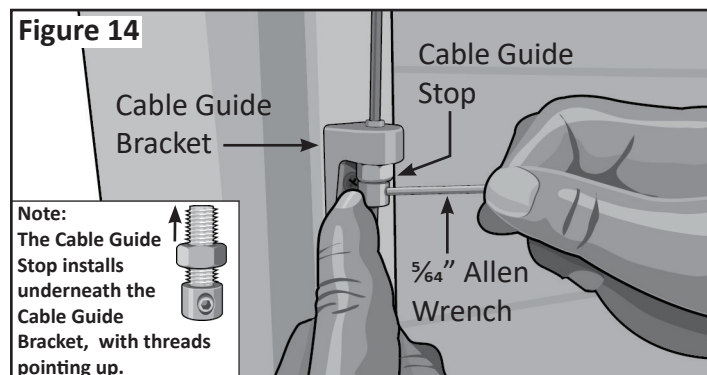

**16.** Ensure the Vinyl Coated Cables are tight. Adjust Cable Tension by turning the Cable Stop Nut counter clockwise, using a 7/16" Open End Wrench. See **Figure 15**.

**Note: Do not over tighten the Cable.**

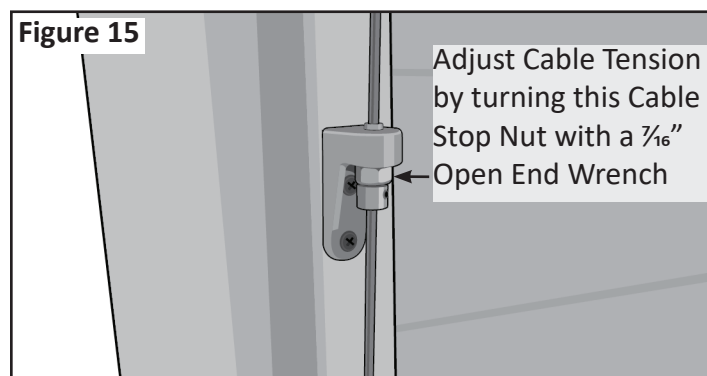

**17.** Trim off excess Vinyl Coated Cable extending from the bottom of the Cable Guide Stops, if desired. Leave one inch of cable below the Cable Guide Stop. See **Figure 16**.

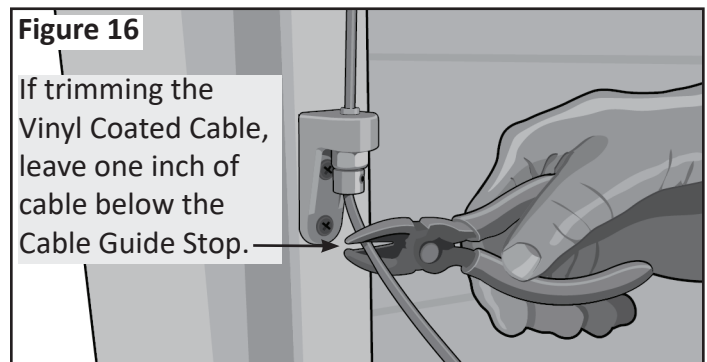

## Operating the EasyShade®



**Note:** The Fabric Panel is preset to stop 36" from the Housing. This position can be changed to lower the Fabric Panel as much as 84" from the Housing.



18. Plug the Motorized EasyShade into a GFI outlet.



19. Press and release the **UP**  button on your Remote Transmitter to retract the EasyShade.

See **Figure 17**.

20. Press and release the **DOWN**  button on your Remote Transmitter to extend the EasyShade to the current "factory setting." **Let the EasyShade stop on its own.** See **Figure 17**.

21. Press and hold the **UP**  and **DOWN**  buttons on the Remote Transmitter, **simultaneously**, until the EasyShade jogs or moves, then release the buttons. See **Figure 17**.



**Note:** The EasyShade is temporarily in Programming Mode. The **UP**  and **DOWN**  buttons on the Remote Transmitter must be pressed and held to reposition the EasyShade. When either button is released, the Fabric Panel will stop moving.

22. Press the **DOWN**  or **UP**  buttons, individually, to adjust the new **Down** stop limit to the position marked in **Step 10**. See **Figure 11**.

**CAUTION:** Do not let the EasyShade extend more than 84" from the Housing. See **Figure 18**.

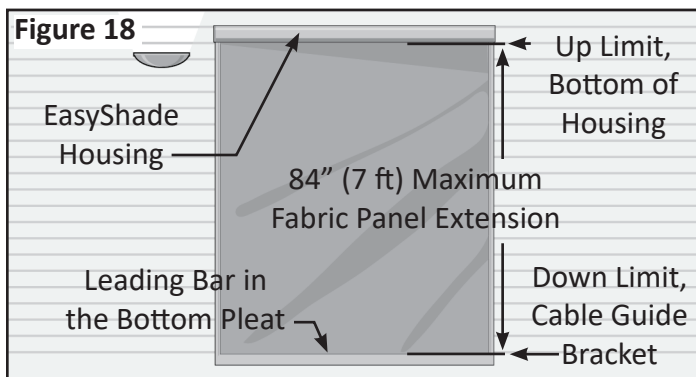
23. Press and hold the **STOP (my)**  button on the Remote Transmitter until the EasyShade jogs, then release. Your new **Down** limit position is set and Programming Mode ends. The **UP** and **DOWN** buttons now return to work in "one-touch" User mode.



24. Test the operation of your EasyShade by using the **UP**  and **DOWN**  buttons on the Remote Transmitter.

24a. Press and release the **UP**  button. The EasyShade will roll up into the EasyShade Housing and stop on its own. The **Up** stop limit should stop the EasyShade automatically, before the Leading Bar in the Bottom Pleat of the Fabric Panel reaches the Housing. See **Appendix A** to adjust the UP stop limit.

24b. Press and release the **DOWN**  button. The EasyShade will unroll from the EasyShade Housing and stop on its own. The **Down** stop limit should stop the EasyShade automatically, before the Leading Bar in the Bottom Pleat of the Fabric Panel reaches the physical limit of the Cable Guide Bracket. See **Appendix A** to adjust the DOWN stop limit.

25. A Wall Mount Post Kit has been provided for the Remote Transmitter. See **Figure 2**. Position the Wall Mount in a safe location, protected from weather.

**CAUTION:** Do not leave your Motorized EasyShade extended during windy conditions, as the uncontrolled movement of the extended EasyShade Fabric Panel could cause damage to the product and surrounding items. Simply retract the Motorized EasyShade by pressing the **UP**  Button on the Remote Transmitter.

**CAUTION:** Do not permit the hand-held Remote Transmitter to get wet as this can affect its proper operation. It is recommended to keep the Remote Transmitter indoors when the EasyShade is not in use or if rain is expected.

**CAUTION:** The installation procedure for the Motorized EasyShade includes the use of Cable Guides to stabilize the extended Fabric Panel during normal use. If your application does not permit the installation of the necessary Cable Guides or you do not plan to install them, you must use additional care to prevent damage to your product. While we do not recommend installing the Motorized EasyShade without the supplied Cable Guides, some customers may determine that their application does not have a vertical surface to install the supplied Cable Guides as instructed.

**Note:** During an electrical outage, you will not have the ability to operate your Motorized EasyShade.

"Congratulations, your installation is complete."



## Remote Transmitters are Unique

Your Motorized EasyShade is programmed to, and packaged with a specific Remote Transmitter and work together as a matched set. If you own more than one Motorized EasyShade, it is recommended to keep the Remote Transmitter that came with that Motorized EasyShade with that specific Motorized EasyShade. It helps to mark them.

Each Remote Transmitter and each Channel of each Remote Transmitter (see **Figure 20**) has its own unique ID.

It is recommended to **use Channel 1** (the first light from the left) of the Remote Transmitter to control the Motorized EasyShade. Channel 1 of each Remote Transmitter is unique from Channel 1 of every other Remote Transmitter. See **Figure 19**.

To control multiple EasyShades with one or more Remote Transmitter or Channel, or to mix and match Remote Transmitters with more than one Motorized EasyShade, see **Appendix C**.

**Figure 19**

Each LED light represents a separate Channel with its own unique ID, which operates as a unique Remote Transmitter.

**Channel 1** is the first light on the left.



Channel Selector Button

Press and release; the active Channel LED will blink.

Press while the active Channel LED blinks, next Channel selected and blinks.

Each Motorized EasyShade is programmed to work on Channel 1 of the Multi Channel Remote Transmitter included in that particular package. Channel 1 of each Remote Transmitter is unique.

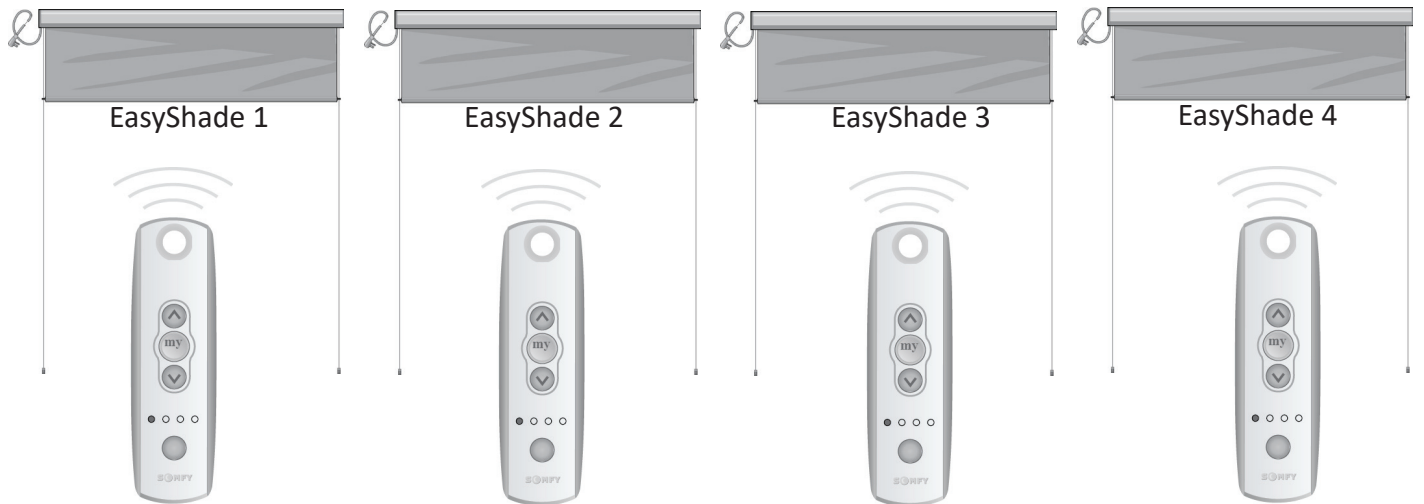

Remote Transmitter 1  
set to Channel 1 works  
only with EasyShade 1







Remote Transmitter 2  
set to Channel 1 works  
only with EasyShade 2

Remote Transmitter 3  
set to Channel 1 works  
only with EasyShade 3

Remote Transmitter 4  
set to Channel 1 works  
only with EasyShade 4

To program multiple EasyShades for individual or multiple Remote Transmitters, see **Appendix C**.

# TROUBLESHOOTING

Installation	
Problem	Solution
<p>Can I “hard-wire” the Motorized EasyShade motor into my home?</p>	<p>The manufacturer cannot be responsible for any changes in the electrical configuration of the Motorized EasyShade.</p> <p>Have your electrician contact Somfy (the motor manufacturer) directly, via their website at <a href="http://www.somfy.com">http://www.somfy.com</a> for more information.</p> <p><b>Note: Some maintenance procedures such as resetting communication between the Remote Transmitter and the Motor (see Appendix B) require power to be interrupted. Therefore, hard-wiring the Motorized EasyShade can interfere with this procedure.</b></p>
<p>Once installation is complete, my Motorized EasyShade will not function.</p>	<ol style="list-style-type: none"> <li>1. Use the <b>Remote Transmitter on Channel 1</b> that came with this Motorized EasyShade. Each Remote Transmitter is uniquely different. For details, see <b>Page 7</b>.</li> <li>2. The Remote Transmitter should be set to work on Channel 1 (one). Press the <b>UP</b>  or <b>DOWN</b>  button on the Remote Transmitter that came with that EasyShade. The first Channel Indicator Light from the left should blink. If not, move to the correct Channel by pressing the Channel Select Button. For more information, see <b>Figure 19</b>.</li> <li>3. Test the power receptacle by plugging in a small appliance.</li> <li>4. Visually inspect the Power Cord for possible damage.</li> <li>5. Listen to the motor. Press the <b>UP</b>  or <b>DOWN</b>  button on the Remote Transmitter and listen for the sound of the motor turning.             <ol style="list-style-type: none"> <li>a. If the motor turns, the problem could be mechanical with the Fabric Panel. The motor may turn, but the Fabric Panel may be stuck inside the Housing. Try tugging on the Leading Bar in the bottom Pleat of the Fabric Panel, see if it unrolls from inside of the EasyShade Housing.</li> <li>b. If the motor does not turn, the problem could be related to the Remote Transmitter. Go to <b>Step 6</b>.</li> </ol> </li> <li>6. Perform self test on the Remote Transmitter:             <ol style="list-style-type: none"> <li>a. Press and hold the <b>UP</b>  or <b>DOWN</b>  button for 5 to 10 seconds. If the LED light blinks for at least 5 seconds, the Remote Transmitter works.</li> <li>b. If the LED does not blink, remove and replace the battery with a new <b>Lithium CR2430</b> battery. To replace the battery, see the battery replacement instructions under Operation, on <b>Page 9</b>.</li> <li>c. If the Remote Transmitter got wet, it may need to be replaced.</li> </ol> </li> <li>7. In extreme cold conditions, verify the EasyShade Fabric Panel is not “frozen” inside the housing.             <ol style="list-style-type: none"> <li>a. A light tug on the Leading Bar in the bottom Pleat of the Fabric Panel may overcome slight freezing conditions.</li> </ol> </li> </ol>

## TROUBLESHOOTING

### Appearance



Problem	Solution
Fabric rolls up unevenly or pulls to one side when the Motorized EasyShade is being closed.	<ol style="list-style-type: none"> <li>1. Check the Aluminum Housing to ensure it is mounted level on the mounting surface.</li> <li>2. It is necessary to have the Guiding Cables completely plumb, up and down. Both the Aluminum Housing and the Cable Brackets must be installed on the same vertical surface or plane, in order for the Fabric to open and close smoothly and evenly. Please check to ensure the Guiding Cable is plumb front to back and left to right. You may need to move the Cable Brackets or shim them to ensure they are located on the same vertical plane.</li> </ol>
Short lines appear in the Fabric Panel.	Very slight lines in the fabric may be noticed near the top of the Fabric Panel. These are caused by clips required to secure the Fabric Panel to the internal Roller Bar. This is normal and should diminish over time, under warm conditions. This may be more pronounced under cool conditions.
Fabric appears folded or pleated as it extends from the EasyShade Housing.	<p>Check the Fabric to ensure it extends freely from the Housing, when the DOWN button is pressed. If the Fabric remains in the Housing while the Motor turns in the DOWN position, the Fabric can get “pleated” in the Housing. To fix this:</p> <ol style="list-style-type: none"> <li>1. Ensure the Fabric does not stick inside the Housing, which can occur in wintry, freezing conditions.</li> <li>2. Move the Closed position so the sewn hem at the bottom of the Fabric, where the Aluminum Leading Bar is located, is just below the opening of the Aluminum Housing where the Fabric rolls out.</li> </ol>

### Operation

Problem	Solution
<p>Remote Transmitter fails to Open or Close the EasyShade.</p> <p>(Remote Transmitter should be set to <b>Channel 1</b>. See Figure 19.)</p>	<ol style="list-style-type: none"> <li>1. Verify the GFI electrical outlet is in proper working order.</li> <li>2. Test the Remote Transmitter (<b>Channel 1</b>) for proper operation; press each button on the front of the Remote Transmitter, holding for 5 to 10 seconds. The LED light should blink for at least 5 seconds. If this fails, replace the Remote Transmitter’s Battery with a new Lithium <b>CR2430</b>.</li> <li>3. If power is good and the Remote Transmitter is good, try Additional Motor Troubleshooting on <b>Page 11</b>.</li> </ol>
<p>Battery Replacement Instructions for Remote Transmitter.</p> <p><u>Note:</u> Replace the Battery if the red light on the Remote Transmitter does not flash when the Up, Down, or “my” button is held down for 5 seconds.</p>	<ol style="list-style-type: none"> <li>1. <b>Remove and replace the Remote Transmitter’s Battery</b> with a new Lithium <b>CR2430</b>.               <ol style="list-style-type: none"> <li>a. Remove the small Phillips screw on the back of the Remote Transmitter,</li> <li>b. Remove back cover,</li> <li>c. Replace the old battery (be sure to note the battery orientation),</li> <li>d. Reinstall the cover with the Phillips screw.</li> </ol> </li> <li>2. If the Remote Transmitter got wet,               <ol style="list-style-type: none"> <li>a. Remove the back cover to allow it to dry out completely,</li> <li>b. Once completely dry, replace the back cover and try again.</li> </ol> </li> </ol> <p><b>Note:</b> An All Weather Remote Transmitter is available for purchase.</p>

## TROUBLESHOOTING

### Operation (continued)

Problem	Solution
My Motorized EasyShade retracts but will not fully close into the Aluminum Housing.	Adjust the Up Limit on your EasyShade motor. See <b>Appendix A</b> , Adjusting the Up and Down Position Limits of the Motor.  If the Fabric Panel has been replaced, new Up and Down Position Limits may need to be set for the Motor. If so, see <b>Appendix B</b> , Programming the EasyShade's Stop Position Settings.
Fabric is stuck inside the Aluminum Housing	In extreme cold conditions, verify the EasyShade Fabric Panel is not "frozen" inside the housing.  A light tug on the Leading Bar in the bottom Pleat of the Fabric Panel may overcome slight freezing conditions.
My Motorized EasyShade rolls out and keeps going and the Fabric Panel begins to sag.	If the Motor stops on its own at a programmed Stop Position, then adjust the Down position stop limit according to instructions in <b>Appendix A</b> .  If the Motor will not stop on its own and you must press the "my" button to stop the motor, then set new Up and Down Stop Position Limits according to instructions in <b>Appendix B</b> .
Can I program multiple Motorized EasyShades to operate on one master Remote Transmitter?	Yes. Each channel on the Remote Transmitter can control one or more Motorized EasyShades.  See <b>Appendix C, Programming Instructions - Multi Channel Remote Transmitter</b> .
Can I use more than one Remote Transmitter to control one Motorized EasyShade?	See <b>Appendix C, Programming Instructions - Multi Channel Remote Transmitter</b> , to mix and match multiple Motorized EasyShades with multiple Multi Channel Remote Transmitters.  It is recommended to always unplug all Motorized EasyShades except the one you are currently programming, to simplify the process.
What if I lose my Remote Transmitter or it becomes damaged?  Do I need to reprogram my motor?	The original Remote Transmitter shipped with your Motorized EasyShade can be easily replaced. Please call Customer Service at <b>800-670-7071</b> to purchase a replacement.  The Programmed Up and Down Stop Limits are permanently stored in the Motor. These settings do not need to be reset or changed due the addition or removal of Remote Transmitters.  Instructions for replacing the Remote Transmitter are included with the replacement Remote Transmitter.
The Motorized EasyShade only operates while the <b>UP</b>  or <b>DOWN</b>  button is being pressed.	The Motor is in Programming Mode. Complete the Programming procedure:  <ol style="list-style-type: none"> <li>1. Unplug the Motor, for 2 seconds, then plug it back in.</li> <li>2. Press and Hold the UP and DOWN buttons until the Motor jogs.</li> <li>3. Press and Hold the PROGRAMMING button (inside the small opening on the rear of the Remote Transmitter) until the Motor jogs.</li> <li>4. Test operation by pressing and releasing the UP or DOWN button.</li> </ol> If the problem persists, please call Customer Service for assistance at <b>800-670-7071</b> .

# TROUBLESHOOTING

## Operation (continued)

### ADDITIONAL MOTOR TROUBLESHOOTING

**Problems:**

EasyShade / Motor Does Not Respond to Remote Transmitter

(Plug/Outlet has power and Remote Transmitter passes Self Test<sup>1</sup> as described at bottom of this page.)

or

EasyShade / Motor only runs while holding down the **UP** or **DOWN** button on the Remote.

**Solution:**

1. Unplug Motor,
2. Wait two seconds,
3. Plug in Motor,
4. If the **Motor DOES jog**, go to **Group A**.
5. If the **Motor DOES NOT jog**, go to **Group B**.

**GROUP A**

1. Press and Hold the **UP** and **DOWN** buttons together, on the Remote Transmitter.
2. Hold until Motor jogs or moves.
3. Press and Hold the **PROGRAMMING** button.
4. Hold until Motor jogs or moves a little bit.
5. Test for normal operation.

**GROUP B**

1. Press and Hold the **UP** and **DOWN** buttons together, on the Remote Transmitter.
2. Hold until Motor jogs or moves.
3. Perform **Steps 9 - 18** in **Appendix B**.
4. Test for normal operation.

If **GROUP A** or **B** (above) does not fix the problem, then . . .

Perform **Steps 1 - 18** in **Appendix B**, or call Technical Support **800-670-7071**.

**<sup>1</sup>Self Test the Remote Transmitter;**

1. Press each button (**Up, Down, my**) on the front of the Remote Transmitter, one at a time.
2. Hold each button for 5 to 10 seconds.
3. LED light should blink for at least 5 seconds, then stop blinking.
4. If Steps 1 - 3 work, the Remote Transmitter is good.
5. If this fails, replace the Remote Transmitter's Battery with a new Lithium **CR2430**.

## APPENDIX A



### Adjusting the Up and Down Stop Position for the Motorized EasyShade®

Follow these instructions to change the position where the EasyShade stops. This is for both the Up and the Down stop positions. See Figure 20.

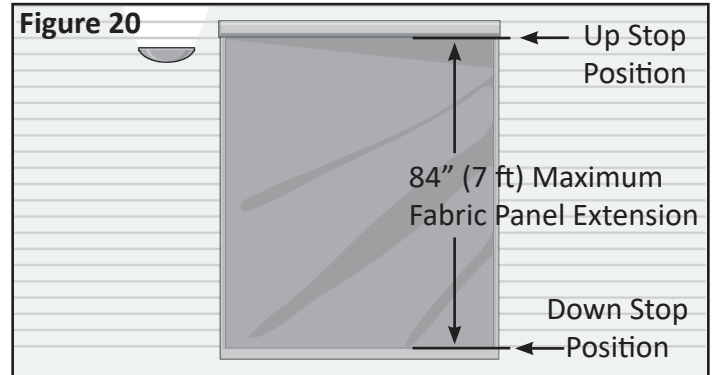

**Note:** Do Not exceed the 84" Down Stop Position Limit as this will cause the Fabric Panel to roll up backwards in the housing. See Figure 20.



#### To Change the Up Stop Position:

1. Move the EasyShade to its current Up (see **Figure 21**) position and **let it stop on its own**.
2. Press and hold the (UP)  and (DOWN)  buttons (see **Figure 23**) simultaneously until the EasyShade jogs or moves, then release.
3. Adjust to a new Up stop position.
4. Press and hold the (MY)  button until the EasyShade jogs or moves, then release.
5. Check the new Up position.

#### To Change the Down Stop Position:

1. Move the EasyShade to its current Down (see **Figure 22**) position and **let it stop on its own**.
2. Press and hold the (UP)  and (DOWN)  buttons (see **Figure 23**) simultaneously until the EasyShade jogs or moves, then release.
3. Adjust to a new Down stop position.
4. Press and hold the (MY)  button until the EasyShade jogs or moves, then release.
5. Check the new Down position.

**Note:** Every EasyShade is programmed to work on Channel 1 (see **Figure 24**) of the specific Remote Transmitter shipped with that Motorized EasyShade. For more information, see Page 7.

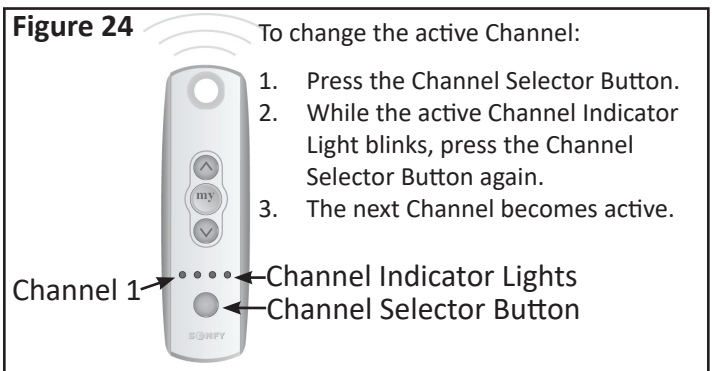
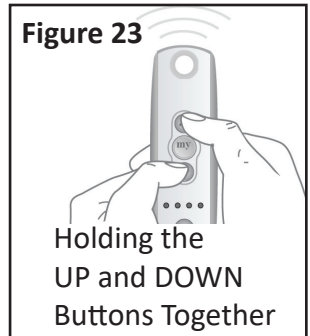
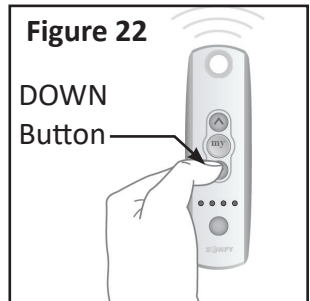
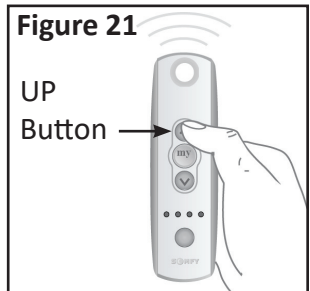



## APPENDIX B

### Reset All Communications Between the Motor and Remote Transmitter

This procedure describes the actions needed to reset the communication between the Motor and the primary Remote Transmitter used to control your Motorized EasyShade.

This procedure programs the EasyShade Motor to accept commands from one primary Remote Transmitter. This procedure overwrites the factory set **Up** and **Down** positions with new **Up** and **Down** positions.

**Note:** To **ONLY** change the Up and Down preset positions, follow the basic procedure in Appendix A.

**Tools needed:** A pen or similar pointing device is needed to press and hold the Programming Button.

**WARNING: ALL STEPS MUST BE FOLLOWED EXACTLY AND COMPLETELY**

Front View



Figure 25

#### **PREPARE MOTOR - See Figures 25 & 26**

1. Read these instructions **FIRST**, completely and thoroughly.
2. Press and Hold the **my** button; the red LED light will blink for at least 5 seconds, then release.
3. Disconnect Power (at the Wall outlet) for 5 full seconds.
4. Connect Power (at the Wall outlet) for 10 full seconds.
5. Disconnect (at the Wall outlet) Power for 5 full seconds.
6. Connect Power (at the Wall outlet). Your EasyShade should move then stop on its own.
7. Press and hold the **Programming** button for **ten seconds, watching for two separate jogs back and forth, several seconds apart.**

**Note:** A single jog is a quick two-direction movement of the motor.

8. Press and Hold the **UP** and **DOWN** buttons together until your EasyShade jogs.

**Note:** The EasyShade now moves **ONLY** while holding down the **UP** or **DOWN** button.

#### **SET PROPER DIRECTION OF MOTOR ROTATION**

9. Press the **DOWN** button to check the direction of the motor.  
The Solar Screen should roll out of the Aluminum Housing, from the side closest to the house.
10. If the direction is incorrect, change direction by holding the **my** button until the motor jogs.  
Press the **DOWN** button again to check for the correct direction of the motor rotation.

#### **SET THE UP AND DOWN POSITIONS**

11. Move the EasyShade to the desired **UP** position.
12. Press and Hold the **my** and **DOWN** buttons together, release when the EasyShade begins to move.
13. Press the **my** button to **Stop** the EasyShade at the desired **Down** setting.
14. Make desired adjustments to the **Down** position.
15. Press and Hold the **my** and **UP** buttons together; release them when the EasyShade begins to **move Up**. **Let the EasyShade stop on its own** at the **UP** position set in step 11.
16. Press and Hold the **my** button, release when the Motor jogs. This step stores the **Up** and **Down** position limits.
17. **Press and Hold the Programming button, wait for jog.** This exits the Programming Mode.
18. Process complete. Test the **Up** and **Down** stop position limits.

**Note:** If steps 8-15 fail, **unplug the Power, plug back in, then begin again from step 8. If that fails to help, go to Advanced Motor Troubleshooting on Page 11.**

Rear View



Figure 26

### Add/Delete a Remote Transmitter

To **ADD** an additional Remote Transmitter for controlling this particular EasyShade.

- Press the Programming button on the back of the Remote Transmitter that was supplied with the EasyShade until the motor “jogs.”
- On the additional Remote Transmitter, press the Programming button until the motor “jogs,” then release.

To **DELETE** a Control Device, repeat the two steps listed above; the additional Control Device is removed.

# APPENDIX C

## PROGRAMMING INSTRUCTIONS - MULTI CHANNEL REMOTE TRANSMITTER

**Note:** Each EasyShade operates on Channel 1 of the Remote that came with it.

Every Channel on every Remote Transmitter is different, but you can mix and match them.

### How to use the Multi Channel Remote Transmitter (see Figure 27):

- To identify the currently selected Channel, press and release the Channel Selector Button once. The currently selected Channel Indicator Light will blink.
- To select the next Channel, press and release the Channel Selector Button while the Channel Indicator Light blinks. The next Channel is selected and that Channel Indicator Light blinks. All 4 lights blinking means Channel 5 is selected.

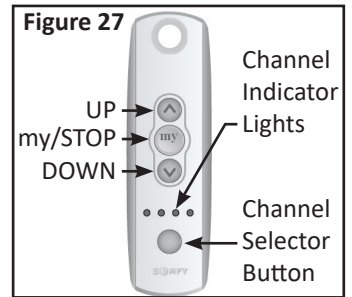

### How to program the EasyShade to work with any Channel (see Figures 28, 29 & 30):

One EasyShade can run on any Channel. See Figure 28.

Add each Channel to the EasyShade, using STEP 1, then STEP 2 in Figure 30.



Figure 28

One Channel can run multiple EasyShades. See Figure 29.

Add that Channel to each EasyShade, using STEP 1, then STEP 2 in Figure 30.

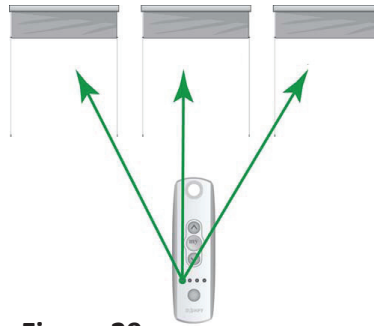
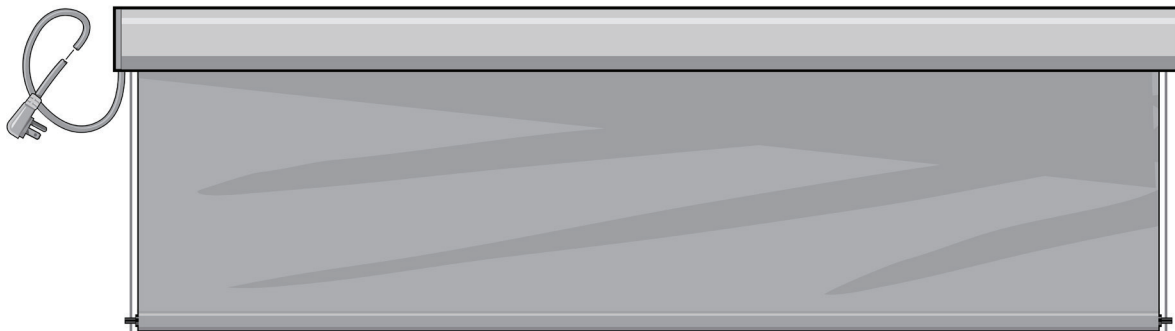

Figure 29

Unwanted Channels can be removed from an EasyShade using STEP 1, then STEP 2 in Figure 30.

**Figure 30 Note:** It is recommended all EasyShades be unplugged from the power source except for the one EasyShade being programmed. This simplifies the process and reduces errors.



#### STEP 1

Select a Channel that **currently controls** the EasyShade being programmed.

Hold the Programming button on this remote until the EasyShade jogs or moves a little bit.

Programming button

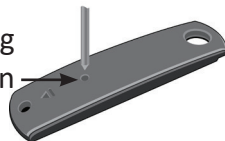

#### STEP 2

Select a Channel to **ADD to, or DELETE from** the EasyShade being programmed.

Hold the Programming button on this remote until the EasyShade jogs or moves a little bit.

Programming button

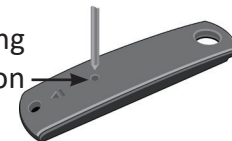

# 5-Year Limited Manufacturer's Warranty for EasyShade®

## A. WHO GIVES THIS WARRANTY?

SunSetter Products, 184 Charles Street, Malden, MA 02148.

## B. WHO IS ENTITLED TO THIS WARRANTY?

This Warranty applies only to the original purchaser who paid for the product and may not be assigned or transferred to subsequent owners. This Warranty applies only to products purchased and installed in the US.

## C. WHAT ARE THE RESPONSIBILITIES OF SUNSETTER PRODUCTS UNDER THIS WARRANTY?

Subject to the terms and conditions set forth herein, SunSetter Products will furnish replacements for parts found by SunSetter Products to be defective in design, manufacture or assembly, under each specific component or product warranty as set forth below.

## D. WHAT ARE THE RESPONSIBILITIES OF THE ORIGINAL PURCHASER UNDER THE WARRANTY?

1. Before any claims may be made under this Warranty, the original purchaser must have paid in full for the product covered under the Warranty, according to the terms and conditions of the pay-plan defined in the original order. **IF THE PURCHASER HAS FAILED TO MAKE FULL PAYMENTS ACCORDING TO THE SPECIFIC PAY PLAN FOR THE PRODUCT, THIS WARRANTY SHALL BE NULLIFIED AND SUNSETTER PRODUCTS SHALL BE RELIEVED FROM ANY RESPONSIBILITY OR LIABILITY UNDER THIS WARRANTY.** The purchaser agrees and acknowledges that this Warranty agreement constitutes an executory contract.

2. The purchaser must use care in installation, maintenance, operation, use, and storage of the product in accordance with the instructions contained with the product. **ANY FAILURE TO INSTALL,**

**MAINTAIN, OPERATE, USE AND STORE THE PRODUCT IN ACCORDANCE WITH THE INSTRUCTIONS CONTAINED WITH THE PRODUCT WILL NULLIFY THIS WARRANTY AND RELIEVE SUNSETTER PRODUCTS FROM ANY RESPONSIBILITY OR LIABILITY UNDER THIS WARRANTY.**

3. Promptly notify SunSetter Products of any claims.

4. The purchaser may be required to provide a photograph of any defective parts. The purchaser may also be required to pay a deposit until the defective parts are returned to SunSetter Products for inspection. The purchaser must obtain a return authorization form from SunSetter Products' customer service department prior to the return of any merchandise and after having received such authorization, return the part or product, freight prepaid, to SunSetter Products.

## E. WHAT IS COVERED UNDER THIS WARRANTY?

1. The following components of the EasyShade are covered under this Warranty, subject to the limitations set forth below. **These components have up to five (5) year limited (prorated) warranty, against manufacturer's defects as outlined below:**

(a) Should the purchaser promptly notify SunSetter Products of such defects within one year (12 months) from the date of the original purchase, the defective component will be replaced at no charge.

(b) After one year but within the warranty period as listed below for each component from the date of the original purchase, a defective component will be replaced upon the purchaser's payment of the prorated amount based on full retail price of the specific components and the number of months from the date of the original purchase till the claim date as percent of the total number of months during the warranty period.

*(Continued on next page.)*

## 2. Covered Components:

**STRUCTURAL COMPONENTS AND GEAR MECHANISM OR ELECTRIC MOTOR** (whichever applies to your model) are **warranted for five (5) years** not to fail under normal conditions if maintained, operated, used, and stored in accordance with the instructions contained with the product.

**VINYL MESH** is **warranted for five (5) years** against:

(a) Excessive fading under normal conditions if maintained, operated, used, and stored in accordance with the instructions contained with the product.

(b) Mildew on vinyl mesh. Mildew will not form on the mesh itself, but may form on dirt and dust that have not been removed from it. The purchaser must clean the vinyl mesh periodically with water and mild soap to prevent dirt from accumulating.

(c) Excessive cracking or peeling under normal conditions if maintained, operated, used, and stored in accordance with the instructions contained with the product.

**SOLAR PANEL ASSEMBLY (solar-powered model)** is **warranted for three (3) years** not to fail under normal conditions if maintained, operated, used, and stored in accordance with the instructions contained with the product.

**BATTERY PACK (solar-powered model)** is **warranted for three (3) years** not to fail under normal conditions if maintained, operated, used, and stored in accordance with the instructions contained with the product.

## F. WHAT IS NOT COVERED UNDER THIS WARRANTY?

1. Any failure or damage of the components that results from any intentional or negligent actions by the purchaser or by any other person is not covered by this Warranty.

2. It is the responsibility of the purchaser to securely fasten the EasyShade to studs, joists, headers or other structural members. Any failure or damage that results from the EasyShade falling from its installed position is not covered by this Warranty.

3. Labor charges connected with installation of replacement parts are not covered by this Warranty.

4. Freight expenses for shipping damaged or replacement parts are not covered by this Warranty and must be paid by the purchaser.

## G. GENERAL PROVISIONS AND LIMITATIONS

1. THE WARRANTY GRANTED HEREIN IS THE EXCLUSIVE REMEDY FOR THE PURCHASER. SUNSETTER PRODUCTS MAKES NO OTHER WARRANTIES TO THE PURCHASER, EXPRESS, STATUTORY, IMPLIED OR OTHERWISE AND ALL IMPLIED WARRANTIES, INCLUDING WITHOUT LIMITATIONS, IMPLIED WARRANTIES OF MERCHANTABILITY AND FITNESS FOR A PARTICULAR PURPOSE, ARE HEREBY DISCLAIMED.

2. TO THE EXTENT PERMITTED BY LAW, SUNSETTER PRODUCTS SHALL HAVE NO LIABILITY TO THE PURCHASER OR ANY OTHER PERSON FOR INCIDENTAL, SPECIAL, CONSEQUENTIAL, INDIRECT OR SIMILAR DAMAGES OF ANY KIND OR NATURE WHATSOEVER, WHETHER ARISING OUT OF BREACH OF WARRANTY OR OTHER BREACH OF CONTRACT, NEGLIGENCE OR OTHER TORT, OR OTHERWISE, EVEN IF SUNSETTER PRODUCTS SHALL HAVE BEEN ADVISED OF THE POSSIBILITY OR LIKELIHOOD OF SUCH POTENTIAL LOSS OR DAMAGE. IN NO EVENT SHALL SUNSETTER PRODUCTS BE LIABLE FOR LOSS OF PROFITS AND/OR WAGES.

3. Some states do not allow limitations on how long an implied warranty lasts, or do not allow the exclusion or limitation of incidental or consequential damages, so the above limitations may not apply to you.

4. This warranty gives you specific rights, and you may have other rights, which vary from state to state.

**A place for your notes:**

**A place for your notes:**