

en-us Use and Care Manual, Installation Instructions

Dryer
WTG86402UC



Welcome to Your New Dryer!

Congratulations on your selection of a new Bosch dryer for your laundry needs. We are confident you will enjoy the superior performance and reliability.

Please do not hesitate to contact our Customer Service department if you have any questions or comments about your new dryer.

Thank you for choosing Bosch.

Visit our web site at www.bosch-home.com for more information and to view a selection of our products.

Table of contents

Important information	4
Purchase information	4
Customer service	4
Your dryer is intended for	5
Importance and meaning of symbols	5
IMPORTANT SAFETY INSTRUCTIONS	6
Introduction to your new dryer	7
Standard features and helpful information	7
Special features	7
Environmentally friendly use of your dryer	7
Dimensions and clearances required	8
Installation for best performance	8
Appliance dimensions	8
Length of power cord and drain hose	8
Minimum clearances	9
Installation Instructions	10
Introduction	10
Before installing the dryer	11
Waste disposal	11
Parts provided with your dryer	11
Accessories for your appliance	12
Installation - step by step	12
Electrical Connections	14
Leveling the dryer	16
Check heating system	16
Preparing to transport the dryer - step by step	16
Reversing the door - step by step	17
Getting to know your appliance	19
Control panel	19
Operating Instructions	20
Your new dryer	20
Before using the dryer for the first time	21
Temporary disconnection of the dryer	21
Using the program selector to choose a drying cycle	21
Program selection	22
Selecting program settings and additional options	22
Loading the laundry	23
Starting the program	23
Indicator of program sequence	24
Childproof lock	24
Selecting a different program	24
Cancel program	24
Program end	24
Removing laundry/switching the appliance off	24
Signal	24
Laundry	25
Preparing the laundry	25
Sorting the laundry	25

Drying tips	25
Program selection table	26
Default Program and Option settings	27
Dry Level	27
Time Dry	27
Finish in	27
Additional Program Option settings	27
Wrinkle Block	27
Low Heat	27
Spin speed	27
Cleaning and care	28
Cleaning the housing and control panel	28
Cleaning the lint filter	28
Cleaning the heat exchanger	29
Cleaning the moisture sensors	30
Cleaning the lint filter area	30
Maintenance of drain hose	30
Troubleshooting	31
Introduction	31
General Troubleshooting	31
STATEMENT OF LIMITED PRODUCT WARRANTY ...	33
Bosch Clothes Dryer	33

Additional information on products, accessories, replacement parts and services can be found at www.bosch-home.com and in the online shop www.bosch-eshop.com

Questions?
1-800-944-2904
www.bosch-home.com
1901 Main Street, Suite 600
Irvine, CA 92614
We look forward to hearing from you!

Important information

Purchase information

Please take a moment to record the following basic information about the purchase of your new Bosch dryer. This information will be helpful in the event you need to contact Customer Service or would like to order accessories or replacement parts for your dryer.

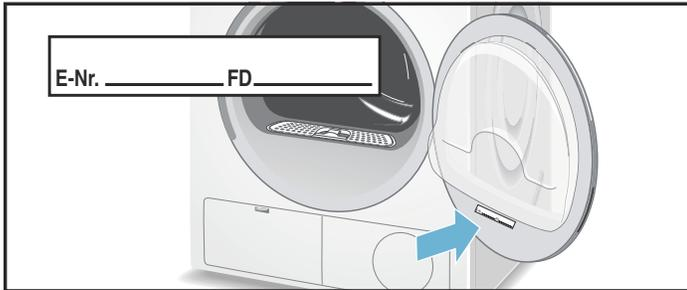

The **E-Nr.** (model number) and the **FD** (serial) number are found on the rating plate label.

The model number includes the slash and a two digit number (eg: "/01"). Please be sure to include the final 2 digit number when filling in your model number. This helps make sure any parts you may need are correctly matched to your specific machine.

Date of Purchase: ___/___/___

Where Purchased: _____

E-Nr. : _____ / _____ (ex: WTG86402UC/01)

FD : _____ - _____ (ex: FD 9304|90007, provides production date)

The manufacturer reserves the right to make changes in the product or manual without notification.

Customer service

Your dryer does not require any special care other than the maintenance and care mentioned in this manual. If you have a problem with your dryer, please consult → *Troubleshooting; Page 31.*

This may save you money. If a technician comes out to advise you of information that is in the Troubleshooting table you may be charged, even if your dryer is still under warranty.

If problems persist and service becomes necessary, contact your dealer, installer or an authorized service center. Do not attempt to repair the appliance yourself. Any work performed by unauthorized personnel may void the warranty.

If you are having a problem with your dryer and are not pleased with the service you have received, please follow these steps:

1. Contact your installer or the Authorized Service Provider in your area and explain to them why you are not satisfied. This will usually correct the problem.
2. If after working with your installer or service technician the problem still has not been resolved to your satisfaction, please let us know either by writing to us at:

BSH Home Appliances
1901 Main Street, Suite 600
Irvine, CA 92614

or calling us at:
1-800-944-2904

When writing or calling please have the following information available:

- E-Nr. (model number, example: WTG86402UC/01)
- FD (serial number, example: 9304|90007)
- Date of Original Purchase (receipt required)
- Date Problem Occurred
- Explanation of Problem

If writing, please also include a daytime telephone number and a copy of the sales invoice.

When calling Customer Service, please be ready to provide the model number **E-Nr.** and **FD** number. This information will help provide the best support for your dryer.

Additional information is available at our website:
www.bosch-home.com

Your dryer is intended for

- Only household use and in a non-commercial environment.
- Household use only for drying washable textiles.
- Children must not do any laundry without supervision.
- Keep pets away from the dryer.
- Recommended operating conditions:
Ambient temperature: 41-95°F / 5-35°C
Relative humidity: under 95%
- Installation by qualified installers.
- Installation in accordance with all regulatory requirements; if in doubt have the appliance installed by a specialist familiar with these requirements.

Read the use and set-up instructions and all other information included with the dryer and act accordingly.

Keep documents for future use.

Importance and meaning of symbols

Important safety information is contained in this manual and on the warning labels located on your dryer.

Standard symbols and headings are used to identify areas where you should take precautions to avoid injury or damage. Please take a moment to become familiar with each of these symbols and what they mean before proceeding.

▲ WARNING

This indicates that death or serious injuries may occur as a result of non-observance of this warning.

▲ CAUTION

This indicates that minor or moderate injuries may occur as a result of non-observance of this warning.

NOTICE: This indicates that damage to the appliance or property may occur as a result of non-observance of this warning.

Tip: This symbol is used to draw the user's attention to important matters.

IMPORTANT SAFETY INSTRUCTIONS

READ AND SAVE THESE INSTRUCTIONS

WARNING

When properly cared for, your new appliance has been designed to be safe and reliable. Read all instructions before using the appliance. These precautions will reduce the risk of burns, electric shock, fire, and injury to persons. When using laundry appliances, basic safety precautions must be followed, including those in the following pages.

Examine the appliance after unpacking it. In the event of transport damage, do not plug it in.

WARNING

TO REDUCE THE RISK OF FIRE, ELECTRIC SHOCK, SERIOUS INJURY OR DEATH WHEN USING YOUR DRYER, FOLLOW BASIC PRECAUTIONS INCLUDING THE FOLLOWING

- Bosch dryers are provided with an Use and Care Manual with Installation Instructions. Read and understand all instructions before using the dryer.
- Do not dry articles that have been previously cleaned, washed, soaked, or spotted with gasoline, dry cleaning solvents, other flammable or explosive substances as they give off vapors that could ignite or explode.
- Before the appliance is removed from service or discarded, remove the door (to the drying compartment) to prevent children from playing or hiding inside. Also remove the power cord/plug.
- Do not allow anyone to climb, lean or hang on any part of the dryer including any protruding components such as the appliance door or a pullout shelf.
- Do not reach into the appliance if the drum is moving.
- Do not tamper with the controls.
- Do not repair or replace any part of the appliance or attempt any service unless specifically recommended in the user maintenance instructions or in published user-repair instructions that you understand and have the skills to carry out.
- Do not use fabric softeners or products to eliminate static unless recommended by the manufacturer or the fabric softener or product.
- Always unplug the dryer from the power supply before attempting any service. Disconnect the power cord by grasping the plug, not the cord.
- To reduce the risk of fire, clothes, cleaning rags, mop heads and the like which have traces of any flammable substance, such as vegetable oil, cooking oil, petroleum based oils or distillates, waxes, fats, etc., must not be placed in the dryer. These items may contain some flammable substance(s) even after washing, which may smoke or catch fire by itself.
- Do not place items exposed to cooking oils in your dryer. Items contaminated with cooking oils may contribute to a chemical reaction that could cause a load to catch fire.
- Do not use heat to dry articles containing foam rubber

(may be labeled latex foam) or similarly textured rubber-like materials or equivalent. Foam rubber materials can ignite by spontaneous combustion.

- Keep flammable materials and vapors, such as gasoline, away from the dryer.
 - Clean lint filter before or after each load.
 - Do not install or store this appliance where it will be exposed to the weather. Hoses and internal parts may be damaged if exposed to freezing temperatures.
 - Do not use the dryer if it has a worn power cord or loose plug.
 - The dryer must only be used for its intended purpose.
 - Always follow the fabric care instructions recommended by the clothing manufacturer.
 - Do not operate the dryer if parts are missing or broken.
 - Do not sit on top of the dryer.
 - To reduce the risk of fire or electrical shock, DO NOT use an extension cord or an adapter to connect the dryer to the electrical power supply.
 - Use the integrated socket only for listed appliances.
 - Always check pockets and remove any objects. Cigarette lighters are particularly hazardous.
 - Do not operate the dryer if any guards and/or panels have been removed.
 - Do not bypass any safety devices.
 - Do not operate this dryer until you are sure that:
 - All services connected to the dryer (power, drain, etc.) have been installed according to the Installation Instructions.
 - Installation and grounding are in compliance with all local regulations and/or other applicable regulations and requirements.
 - Failure to install, maintain and/or operate the dryer according to the manufacturer's instructions may result in injury and/or damage.
 - To avoid floor damage and mold growth, do not let spills or splashout cause standing water around or under the appliance.
 - See the Installation Instructions section in this manual for grounding requirements.
→ *Electrical Connections; Page 14*
 - The IMPORTANT SAFEGUARDS and WARNINGS presented in this manual do not cover all possible conditions that may occur. Common sense, caution and care must be exercised when installing, maintaining or operating the dryer.
 - Always contact your dealer, distributor, service agent or the manufacturer about any problems or conditions that you do not understand.
 - Follow the Safety Information in the INSTALLATION INSTRUCTIONS and the OPERATING INSTRUCTIONS.
-

⚠ **IMPORTANT SAFETY INSTRUCTIONS**

READ AND SAVE THESE INSTRUCTIONS

WARNING

WARNINGS FOR CHILDREN

- Do not allow children to play on or in the appliance. Close supervision of children is necessary when the appliance is used near children.
- Make sure to utilize all child lock/safety features of your appliance, and be sure to turn the appliance **Off** when not in use.
- Appliances are not intended for use by children, however when children become old enough to operate the appliance, it is the responsibility of the parents or legal guardians to ensure they are instructed in safe practices by qualified persons.

- Keep all laundry aids (including detergents, bleach, fabric softeners, etc.) out of the reach of children.
-

WARNING

STATE OF CALIFORNIA PROPOSITION 65 WARNINGS

This product contains chemicals known to the State of California to cause cancer, birth defects or other reproductive harm.

SAVE THESE INSTRUCTIONS!

Keep These Instructions for Future Reference.

In case of change of ownership, manual should be conveyed with the dryer.

Introduction to your new dryer

⚠ **WARNING**

RISK OF FIRE, ELECTRIC SHOCK OR INJURY

To reduce the risk of fire, electric shock or injury to persons, read the IMPORTANT SAFETY INSTRUCTIONS of this manual before installing or operating this appliance.

→ *IMPORTANT SAFETY INSTRUCTIONS; Page 6*

About this manual

These operating and installation instructions apply to more than one model of dryer. Illustrations used may show details that differ from your particular model.

Read your user manual. It contains valuable information about safety, installation and operation of your new appliance.

This can save you time, make it easier to correctly install and use your dryer, and improve your overall satisfaction with your new appliance.

Standard features and helpful information

Thank you for choosing Bosch for your laundry appliance needs.

Please read and follow the use and care, important safety instructions and troubleshooting information contained in this manual. Please retain this manual for future reference.

→ *Troubleshooting; Page 31*

This dryer complies with UL 2158 Electric Clothes Dryers.

Standard features

- Sensor controlled auto cycles.
- 17.7 lb (8 kg) large drum capacity (for regular cotton loads).
- Large door opening, 180° opening angle.

Quality tested

Each dryer which leaves our factory has undergone a thorough performance test and is in full working condition.

Web Site

Visit our web site at www.bosch-home.com for more information and to view a selection of our products.

Special features

- A distinctive feature of your dryer is low energy consumption.
- Bosch dryers feature advanced operation philosophy, customized drying programs and a solid touch and feel making them a user-friendly household assistant.
- Bosch load sensing feature controls power consumption for each cycle based on the amount and type of laundry. This automatic feature optimizes energy efficiency.

Environmentally friendly use of your dryer

Your new Bosch dryer is designed to use energy in a highly efficient way to help reduce operating costs, conserve resources and protect the environment.

To save energy, money and time, Bosch recommends the following:

- **Spin the laundry thoroughly**

Before drying, spin the laundry thoroughly in the washing machine. Use the highest possible spin speed for the type of laundry. Higher spin speeds reduce the drying time and the energy consumption.

- **Use optimum load**
Utilize the maximum amount of laundry for the appropriate cycle. However, do not exceed recommended loads.
- **Clean filter**
Clean the lint filter before or after each drying process.
→ *Cleaning the lint filter; Page 28*

- **Air inlet on the dryer**
Do not cover or allow any articles/items to restrict the air inlet on the front of the dryer.
- **Energy-saving mode**
The display panel lighting goes out after a few minutes and **Start/Pause** flashes. To activate the display, touch any button.
Energy-saving mode is not activated if a program is running.

Dimensions and clearances required

Installation for best performance

▲ CAUTION

DO NOT INSTALL THE DRYER:

- outdoors,
- in an environment with dripping water,
- near flammable materials,
- in rooms which are at risk of frost,
- in rooms which may contain gas or other fuels,
- on carpets.

The dryer should be installed in an open area with no restrictions to ambient air for the best drying results. Space allowances to fully open the door should also be considered.

Do not operate the dryer at temperatures above 95°F (35°C) or below 41°F (5°C). Low temperatures affect the drying process and may prolong the drying times.

The installation surface (floor) must be level and structurally sound. Using the bubble level and the height-adjustable feet installed on the appliance, level the appliance side to side and front to back.

Appliance dimensions

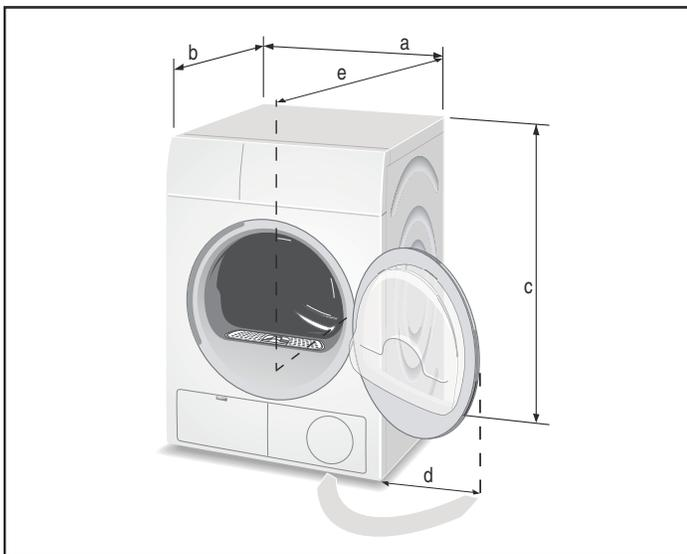

Label	Dimension	U.S. Inches	Metric cm
a	Width	23.6	60
b	Depth (to front of door)	25	63.5
c	Height (minimum)	33.2	84.3
	Height (maximum)	34	86.4
d	Side clearance (door open 180°)	16	40.6
e	Depth (door open 90°)	42.9	109

Length of power cord and drain hose

	To Left*		To Right*	
	U.S. Inches	Metric cm	U.S. Inches	Metric cm
Power Cord	42	106.7	60	152.4
Drain Hose	76	193	55	139.7

* Facing the front of the dryer

Minimum clearances

Closet: Stacked

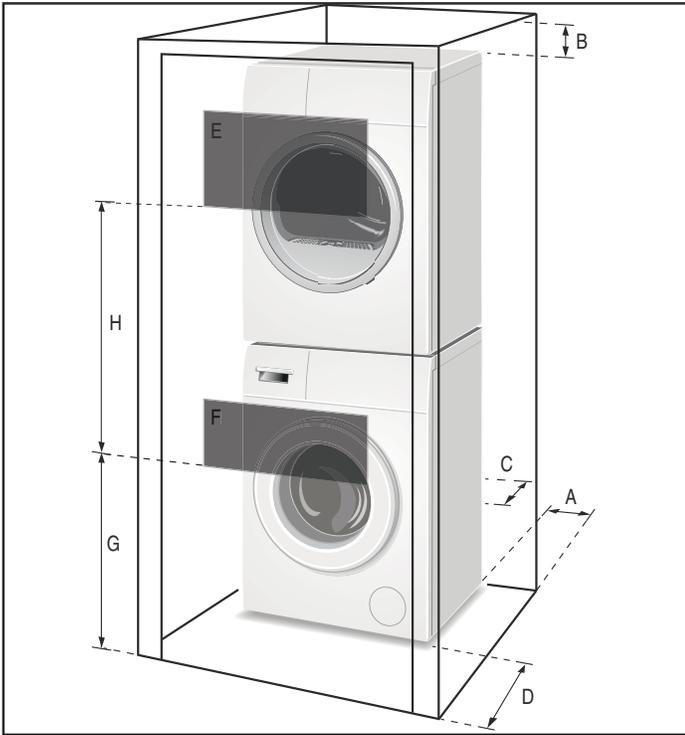

Closet: Stand alone (shown) or Side by Side

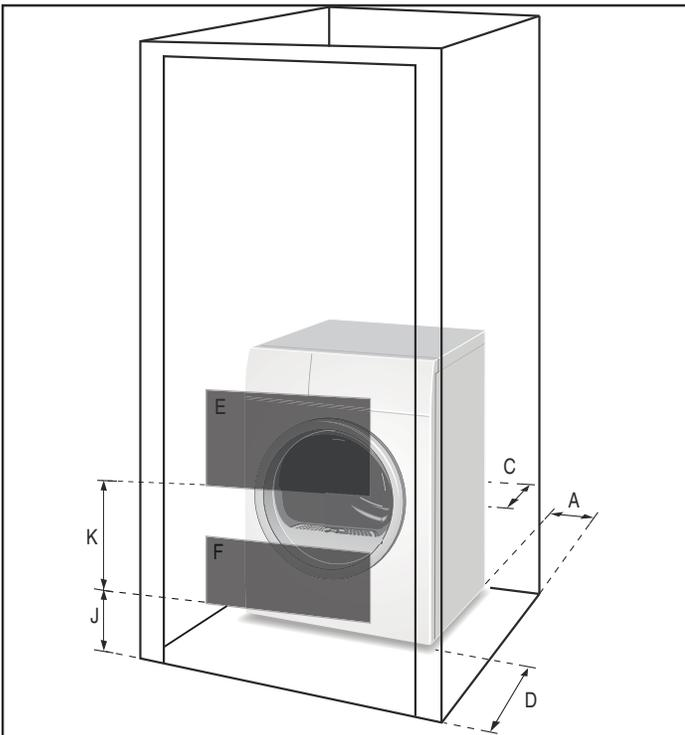

Label	Dimension	U.S. Inches	Metric cm
A	Both Sides	0.6	1.5
B	Top	6.3	16
C	Rear	2.5	6.2
D	Front	2.4	6

Label	Dimension	U.S. Inches	Metric cm
-------	-----------	-------------	-----------

E & F are minimum area size!			
E	Top Vent	63 sq.	404 sq.
F	Bottom Vent	63 sq.	404 sq.
Vent spacing is actual (not minimum dimensions)			
G		37	94
H		26	66
J		3	7.6
K		29	73.6

Under counter (Preferred)

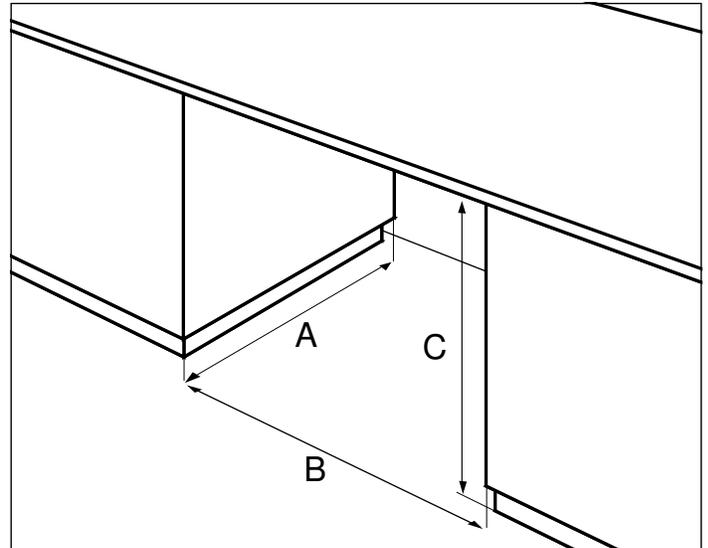

Front of the appliance fully open.
No doors or coverings.

Minimum opening dimensions

A	28 in.	71.1 cm
B	23.8 in.	60.5 cm
C	35.5 in.	90.2 cm

Under counter (Less Desirable)

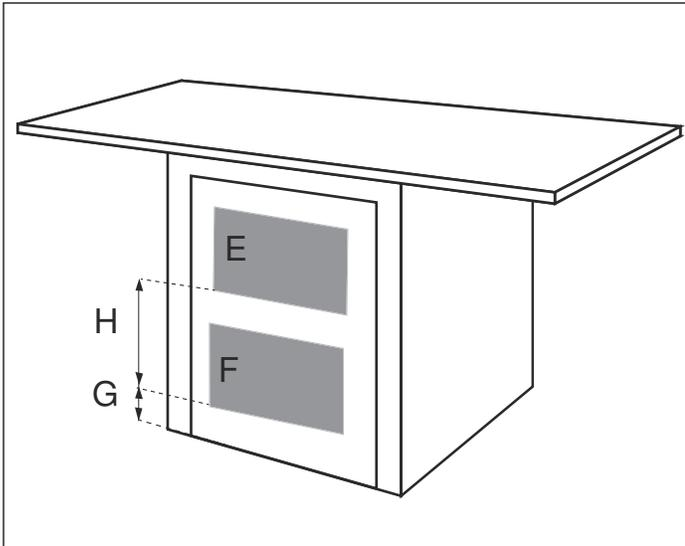

If front of the appliance is covered ventilation openings must be installed.

E & F are minimum area sizes

E	63 sq.in.	404 sq. cm
---	-----------	------------

F	63 sq.in.	404 sq. cm
---	-----------	------------

G & H**actual spacing dimensions for min. open area sizes**

G	3 in.	7.6 cm
---	-------	--------

H	14 in.	35.6 cm
---	--------	---------

Installation Instructions

READ AND SAVE THESE INSTRUCTIONS

Introduction

Read these installation instructions completely and carefully before starting to install your new dryer. The information contained can save you time and effort and will help to ensure optimum performance of your new dryer. Be sure to observe all warnings and cautions.

WARNING

▲ WARNING

RISK OF FIRE, ELECTRIC SHOCK OR INJURY TO PERSONS

- To reduce the risk of fire, electric shock or injury to persons, read the Important Safety Instructions at the beginning of this manual before installing or operating this appliance.
 - To reduce the risk of severe injury or death, follow all installation instruction.
 - Clothes dryer installation must be performed by a qualified installer, according to these instructions and according to all local codes.
 - In addition to the installation and safety information in this manual, the local water and electric authorities (services) may have special requirements that must be followed.
 - Install the clothes dryer according to the manufacturer's instructions and local codes.
-

▲ CAUTION

- Dryer is heavy. Do not lift it by yourself, use additional help and care when lifting and positioning.
 - If in doubt, have the appliance installed by an authorized technician.
 - Take care to not damage the appliance. Do not hold on to protruding parts (e.g. door) when lifting. Do not push against the appliance door glass due to risk of damage.
 - Do not install the appliance outdoors or in an area exposed to freezing conditions.
 - If freezing conditions exist where appliance is located all drain water must be removed from hoses, sumps, pumps, etc.
 - Hidden surfaces may have sharp edges. During service use caution when reaching inside the dryer housing.
-

These installation instructions are intended for use by qualified installers. In addition to these instructions, the installation must comply with:

- for the United States - National Electrical Code, ANSI/NFPA70 - and latest editions of the State and Municipal and/or local regulations.
- for Canada - Canadian Electrical Code C22.1 - and the latest editions of the Provincial, Municipal and/or local regulations.

Before installing the dryer

Unpacking the appliance

⚠ CAUTION

Remove the appliance packaging carefully to prevent damage to the surfaces.

After removing the packaging, immediately remove any objects from the drum.

Check the dryer for transportation damage. Do not connect the utilities (power or drain) to a dryer which is visibly damaged. If in doubt, contact your dealer.

Waste disposal

Disposal of Packaging Materials

After unpacking your new appliance dispose of the protective packaging materials in an environmentally friendly way. Ask your dealer or inquire with your local authority regarding currently acceptable means of disposal.

⚠ WARNING

WARNINGS FOR CHILDREN

Do not let children play with packaging and associated parts to avoid risk of choking or suffocation.

Disposal of Your Old Appliance

Your old appliance can be recycled if it is no longer to be used. Prior to disposing of your old appliance observe the following precautions to reduce safety risks.

⚠ WARNING

TO AVOID RISK OF INJURY OR DEATH, DO THE FOLLOWING

- after unplugging the old appliance, remove the electric power cord and dispose of properly.
- remove the door or permanently disable the door lock to prevent children from being locked inside.

Parts provided with your dryer

Back side of the dryer

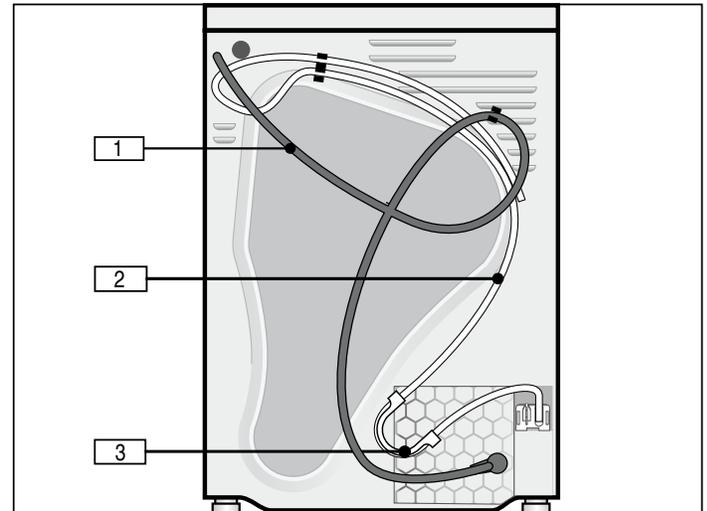

1 power cord with plug

2 drain hose connected to the dryer

3 elbow to form the hose to fit the drain

Dryer drum contents

A literature pack and drain hose pack are shipped in the dryer drum. Be sure to remove these items before using the dryer.

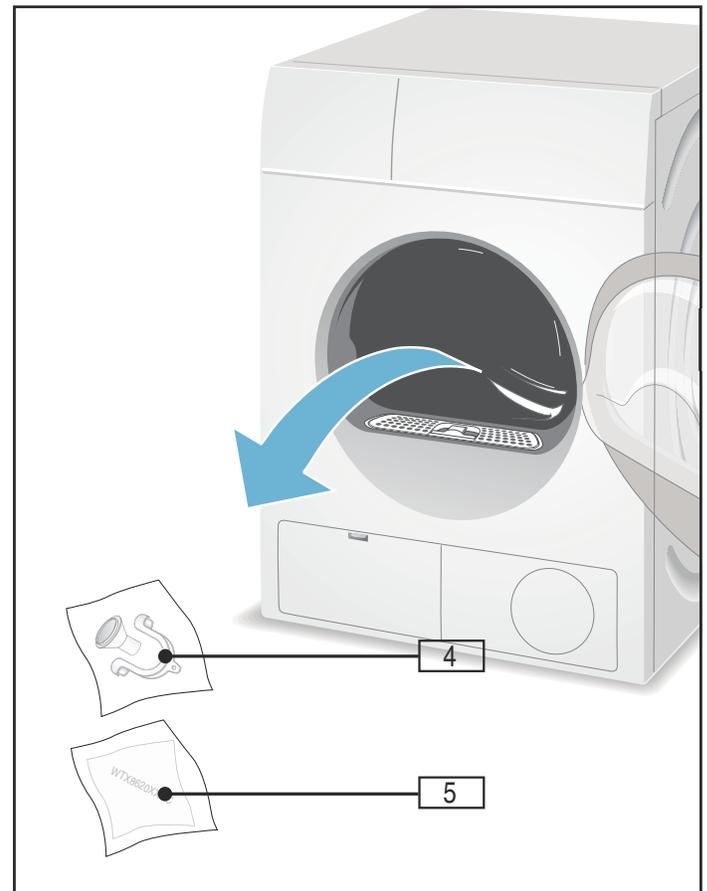

- 4 drain hose pack contents:
 - (2) plastic ties for securing drain hose
 - plastic connector
 - summary of drain hose installation instructions
- 5 literature pack contents:
 - User manual
 - Warranty

NOTICE: If any parts are missing please notify your dealer immediately.

Accessories for your appliance

Pedestal

The dryer can be mounted on a special pedestal for easier loading and unloading.

Pedestal item number: **WMZ 20500**

Stacking kits

The dryer can be stacked on a Bosch washer of the same dimensions to save space.

Stacking kit without a shelf: **WTZ20410**

Stacking kit with a shelf: **WTZ11400**

Drying rack

A drying rack placed inside the dryer for drying wool items, shoes, etc. is available.

Drying rack item number: **WMZ20600**

Accessories can be purchased from customer service or your local dealer.

→ *Customer service; Page 4*

Installation - step by step

1. Unpack the dryer.
2. Remove all objects from the dryer drum.
3. Check the dryer for visible damage.
4. Position the dryer near the installation location.

5. Disconnect the power cord and drain hose from their clips on the back of the dryer.

⚠ CAUTION

Do not disconnect the drain hose from the sump/pump connection at the bottom of the dryer.

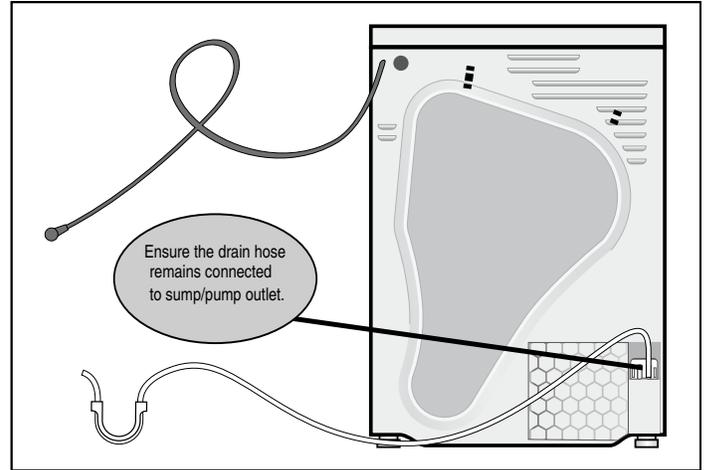

NOTICE: Do not reuse an old or different drain hose. Only use the drain hose included with the dryer.

6. Connect the outlet end of the drain hose to a standpipe or other drain inlet. Examples are shown below.

⚠ CAUTION

APPLIANCE DAMAGE COULD OCCUR IF DRAIN WATER FLOWS BACK INTO THE APPLIANCE
In all drain conditions, scenarios, or connections you must ensure:

- The drain water from the hose is free flowing and not obstructed allowing adequate water flow.
 - Drain opening is not sealed in any way and ventilated enough not to cause a back siphon.
 - The end of the drain hose does not protrude into the pumped out or standing water.
 - Be sure to follow all local codes and regulations in draining the condensate water to a suitable drain.
-

Examples of connections:

- Plumbing box or Standpipe connection:
For most plumbing box installations (with adjacent washer) the plastic elbow supplied with the dryer will not be used and must be removed from the dryer drain hose.
1. Fasten the dryer drain hose to the washer drain/elbow as shown in picture "A". Secure with plastic ties supplied.

⚠ CAUTION

Do not over tighten plastic ties pinching or causing a restriction in the drain hose.

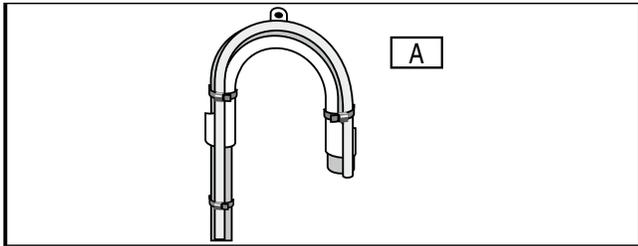

2. Place drain hose assembly into standpipe as shown in picture "B".

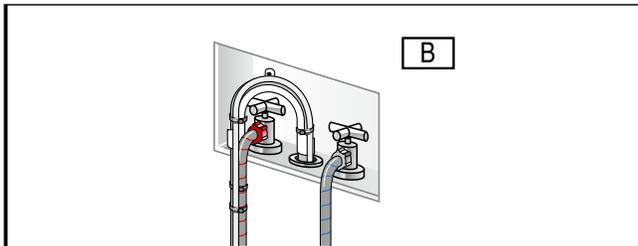

- Sink/Basin or Floor drain:
If using the elbow supplied on the hose re-position elbow closer to the drain end of hose and fasten with the plastic ties as shown in picture "C".

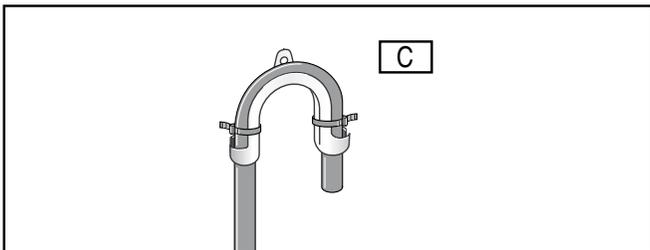

Secure hose and/or elbow as shown below. Sink "D" or floor "E".

NOTICE: Examples shown are for reference only. Not all fittings, connectors, nuts, brackets, ties, etc. are supplied to accommodate every application.

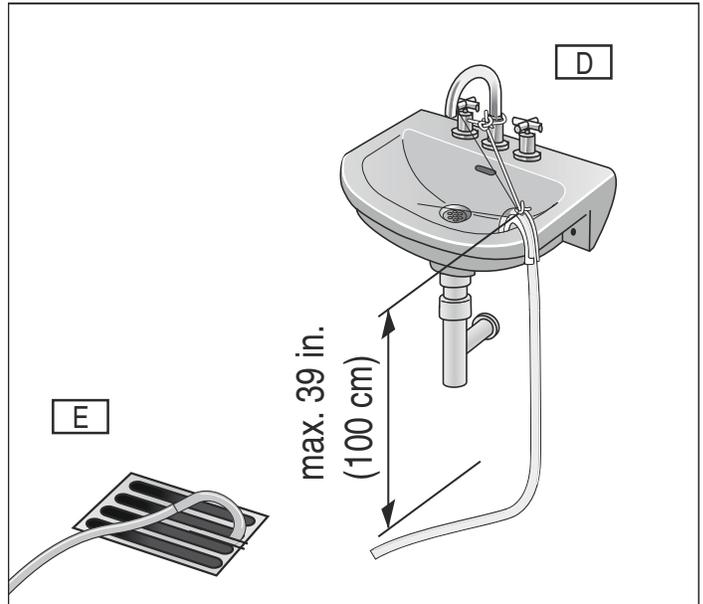

Maximum height of drain is 39 in. (100 cm).

- Sink Drain Pipe:
Attach and secure drain hose as shown below in picture "F".
Use a standard hose clamp which can be purchased from your local hardware store.

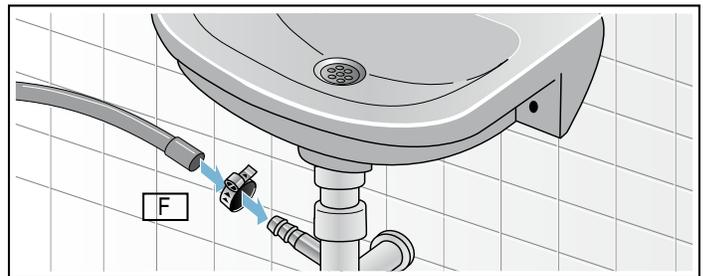

NOTICES

- Examples shown are for reference only. Not all fittings, connectors, nuts, brackets, ties, etc. are supplied to accommodate every application.
- Ensure there are no kinks or crimps along the entire length of hose.

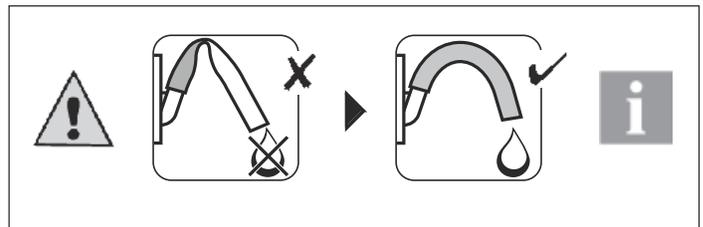

- If installed in an upper floor of a multi-story building, the dryer should be installed on a drained floor to prevent water damage to lower floors in the event of a leak.

Electrical Connections

Power Cord

The attached power cord is a standard 4-wire dryer cord and is UL approved and listed in the USA and Canada. It meets the following requirements:

- 208-240 volt rated (minimum);
- 30 amps;
- Type SRDT or DRT (UL 2158).

NOTICE: If your specific installation requires a 3-wire power cord follow the installation instructions for such in the next section of this manual.

ALL ELECTRICAL CONNECTIONS AND CIRCUITS

⚠ WARNING

ELECTRIC SHOCK HAZARD

- Do not pull on the power cord to unplug the dryer.
 - Protect the power cord from physical damage such as being twisted, kinked, pinched, or walked on for example.
 - DO NOT use an extension cord or an adapter to connect the dryer to the power supply.
 - Make sure:
 - The power cord fits into the outlet/receptacle.
 - The home's internal power supply circuit wire size is sufficient and electrically grounded.
 - The outlet/receptacle used to power the dryer must be connected to an individual 30 amp Branch Circuit.
 - Do not cut, remove or bypass the grounding prong on the power cord end.
 - Do not modify the plug provided with the appliance; if it will not fit the outlet, have a proper outlet installed by a qualified electrician.
 - The power cord must only be replaced by a qualified technician or licensed electrician to help avoid a fire/electric shock hazard.
- Replacement power cords can be purchased through our Customer Service department.
- Use only a UL listed 30 amp power cord.
 - Do not reuse old power cord.
 - Do not make a sharp bend or crimp wiring or conductors at connections.
 - Use only a 4-wire/conductor power cord when the appliance is installed in a mobile home, recreational vehicle, in a new branch-circuit installation or where the local codes do not permit grounding through the neutral.
-

⚠ WARNING

ELECTRIC SHOCK HAZARD

To reduce the risk of electrical shock:

- Only pull out the power cord by the plug end and never by the cord, as this could damage it.
 - Never touch or hold the plug end or power cord with wet hands.
 - Never unplug the plug end during operation.
-

⚠ WARNING

ELECTRIC SHOCK HAZARD

Improper connection of the equipment-grounding conductor may result in electric shock. Have the appliance checked by a qualified technician or licensed electrician if you are in doubt as to whether the dryer has been properly grounded.

GROUNDING INSTRUCTIONS

⚠ WARNING

ELECTRIC SHOCK HAZARD

This appliance must be electrically grounded. In the event of malfunction or breakdown, grounding will reduce the risk of electric shock by providing a path of least resistance for electric current.

This appliance is equipped with a cord that has an equipment grounding conductor and a grounding plug.

The plug must be plugged into an appropriate outlet that is properly installed and grounded in accordance with all local codes and ordinances.

If a ground fault circuit breaker is used, ensure it has this symbol: .

This symbol guarantees compliance with all current regulations.

SAVE THESE INSTRUCTIONS!

Connecting a 3-wire power supply cord

⚠ WARNING

ELECTRIC SHOCK HAZARD

To reduce risk of fire, electric shock, serious injury, or death follow the installation instructions below carefully or have work done by an qualified electrician.

The power cord must meet the following requirements:

- 208-240 volt rated (minimum);
- 30 amps;
- Type SRDT or DRT (UL 2158).

1. Unplug the current power cord being used from the outlet/receptacle.
2. To disconnect and/or reconnect a new power cord you must remove the top cover of the appliance as shown below.
 - A. Remove the two T20 torx head screws.
 - B. Push the top cover toward the rear of the appliance and lift up.

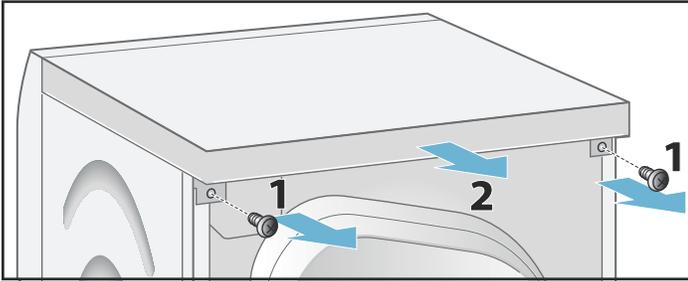

3. Open the connection box toward the rear of the appliance by removing the T20 torx head screw fastening the cover.



4. Remove the 4-wire power cord (as supplied):
 - A. Remove the 3 Philips screws (2 labeled **L** and one labeled **N**).
 - B. Remove the green grounding screw **PE** (T20 torx).

NOTICE: Be careful not to drop the screws into the dryer.

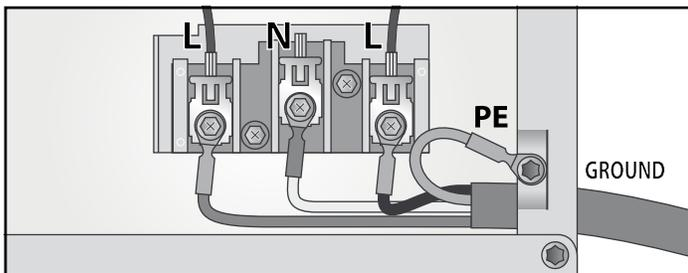

5. Loosen the strain relief clamp screw (Philips head) on rear of the connection box.
6. Pull the old power cord out of the connection box.
7. Install the new power cord back through the strain relief clamp.

NOTICE: Ensure the strain relief clamp has not been moved and its clamping screw(s) are outside the rear of the connection box.

8. Ensure the terminal ends are long enough and are formed (bent) so that no part of them (wires or

terminal ends) come in contact with connection box enclosure.

NOTICE: Use only open-end spade lugs.

9. Ensure the terminal ends are long enough and are formed (bent) so they will align with the terminal block fastening locations (screw holes).
10. Reinstall the 2 terminal block screws (Philips head) at locations **L** as shown below.
11. If the ground wire shown below from **N** to **PE** is not part of the 3-wire cord assembly you have it must be obtained/purchased separately and **it must be installed**.
12. Install the last terminal block screw (Philips) and 1 grounding screw (T20 torx) at locations **N** and **PE**.

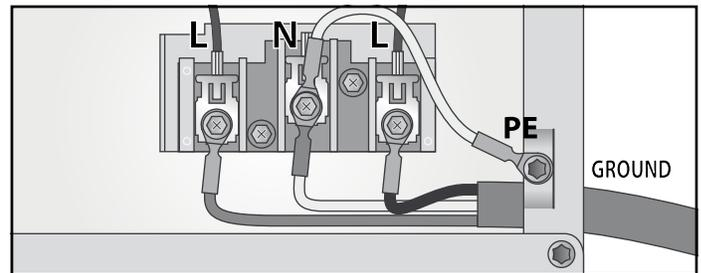

13. Tighten the strain relief screw ensuring the power cord cannot be pulled out of the connection box but not so tight as cut the power cord insulation.
14. Reinstall the connection box cover making sure all wires are routed so they do not touch any part of the enclosure and are secure.
15. Reinstall the appliance top cover as previously described in "2" above.

Integrated electrical receptacle

This appliance is equipped with a 208/240V 15A receptacle for use ONLY with Bosch washer.

⚠ CAUTION

Do not use this receptacle to power any other device.

If any other electrical device is plugged into this receptacle Bosch assumes no liability.

⚠ CAUTION

Use integrated electrical receptacle only for 208/240V Bosch washers.

Leveling the dryer

Importance of leveling the dryer

It is important that your dryer is level and that all four dryer feet press with equal pressure against the floor. This will help assure the quietest, most vibration-free use of your dryer.

To adjust the dryer feet:

1. Install the dryer on a level and solid surface, preferably in a corner of a room.
2. If the floor is uneven (or not level) adjust the dryer feet as required to level the dryer. Do not place anything under the dryer feet to help level the dryer.
3. Extend the dryer feet no more than is necessary. The more the feet are extended, the more vibration the dryer will experience. Start with the dryer feet turned all the way in and adjust each foot as necessary.
4. Use a bubble level to check the top of the dryer to make sure it is level side to side and front to rear.
5. Press down on each corner of the dryer top to make sure the dryer does not "wobble". There should be no "give" or movement. All four dryer feet should press equally against the floor. This is just as important as the dryer being level to prevent vibration.

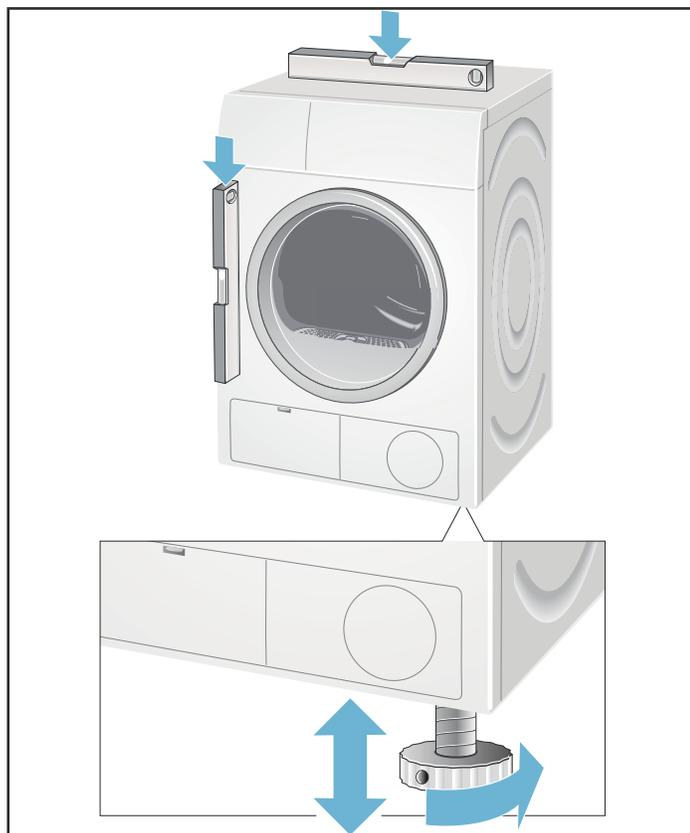

Check heating system

1. Check that the drum is empty.
2. Close the dryer door.
3. Switch the dryer to **Cotton Extra Dry** and then touch the **Start/Pause** button.
4. After 2-3 minutes touch the **Start/Pause** button and open the door.
 - If the interior of the dryer feels warm, the dryer has been connected properly. Switch the dryer to **Off**.
 - If the dryer does not work, switch the dryer to **Off**. Look in the Troubleshooting section of this user manual for hints in solving the problem.

Preparing to transport the dryer - step by step

1. Rotate the program selector to **Off**.
2. Pull out power supply plug.
3. Place any accessories in the drum.
4. Close the door and secure with adhesive tape.
5. Screw the height-adjustable feet of the dryer into the housing to prevent them from being damaged during transportation.

Reversing the door - step by step

Tip: To reverse your dryer door side:

- Use only T20 (Torx) type screw driver to remove and reinstall door screws.
- Do not use any other tools to reverse the door (hinge or latch).

1. Rotate the program selector to **Off**, pull out power supply plug and open the door fully.

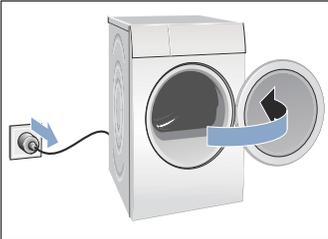

2. Remove the screws from the door and pull out the door from the dryer.

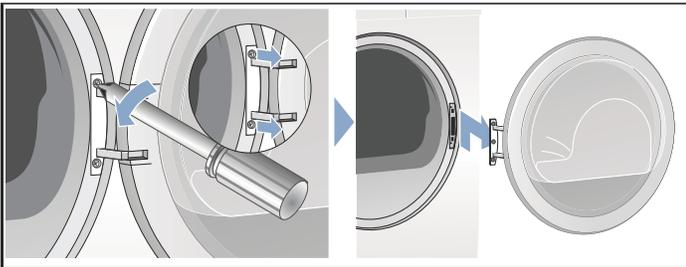

3. Put the door on a flat, smooth, but secured surface, e.g. on a towel or dishcloth lying down on the floor or table.

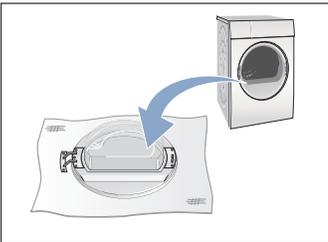

4. Remove screws from the hinge insert and then remove it from the door.

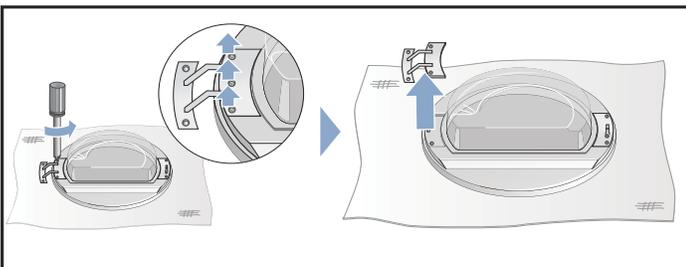

5. Remove screws from the hook insert and then remove it from the door.

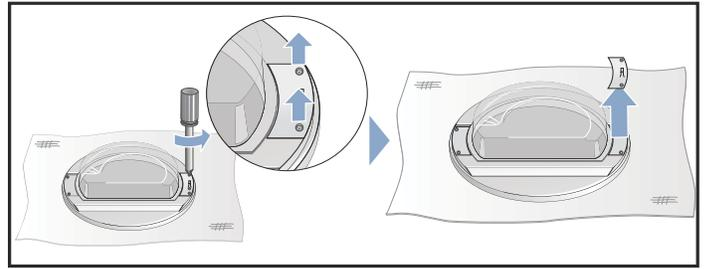

6. Follow the instructions at images below to unlock the door ring.

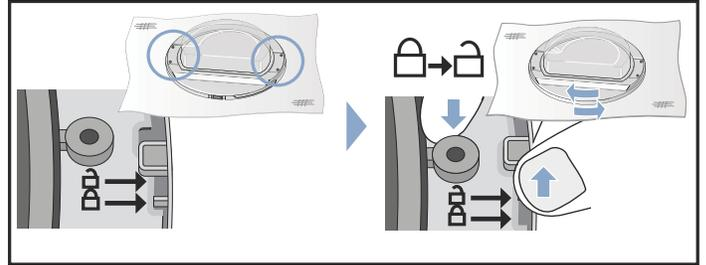

7. Separate the door and ring then reverse the ring and fit the door and ring back together.

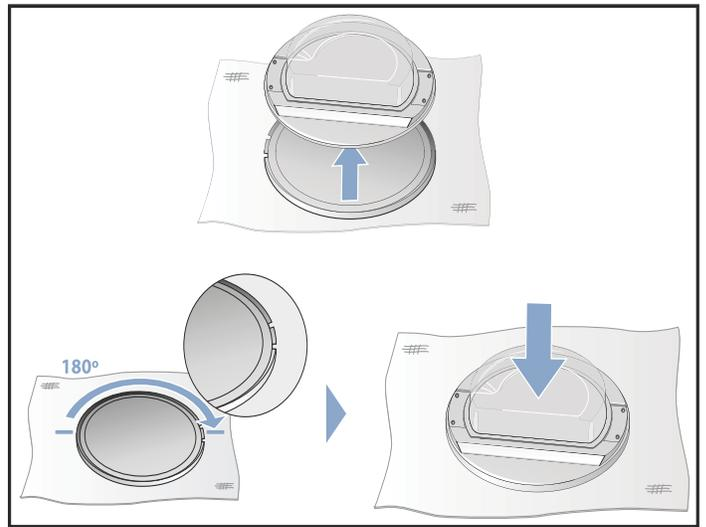

8. Follow the instructions at images below to lock the door ring.

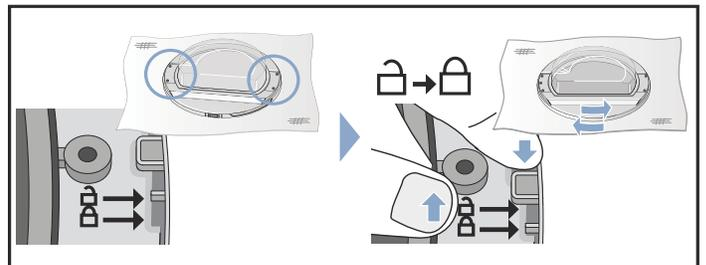

9. Prepare the hinge insert and the hook insert to install and then screw them following the instructions below.

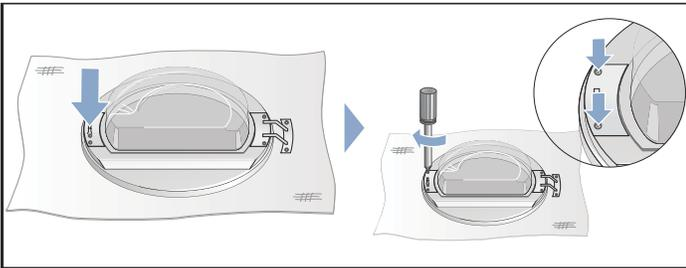
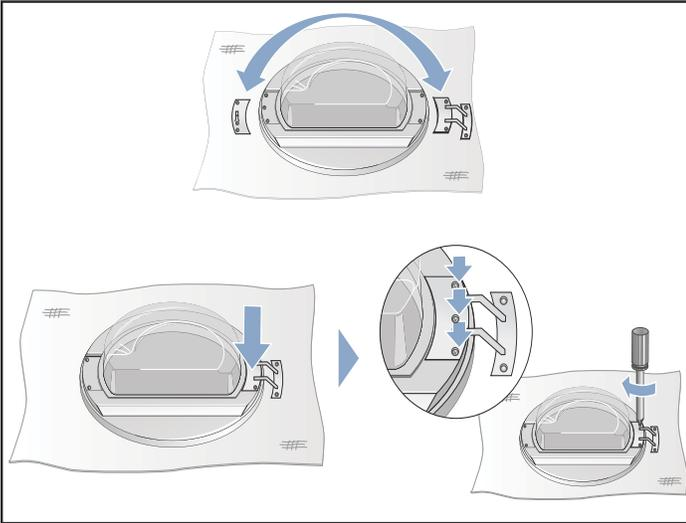

10. Remove screws from the door lock cover and then remove it from the dryer.

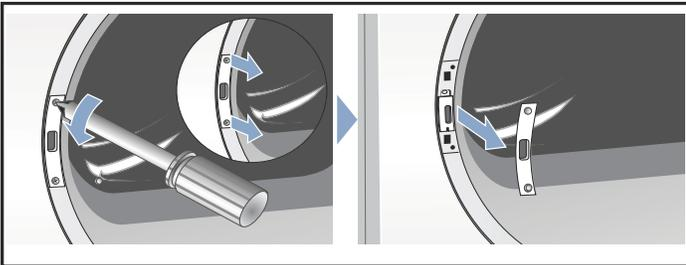

11. Remove the door lock from the dryer.

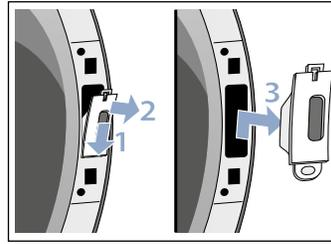

12. Install the door lock (1) and then door lock cover (2) at the opposite site of the door seal.

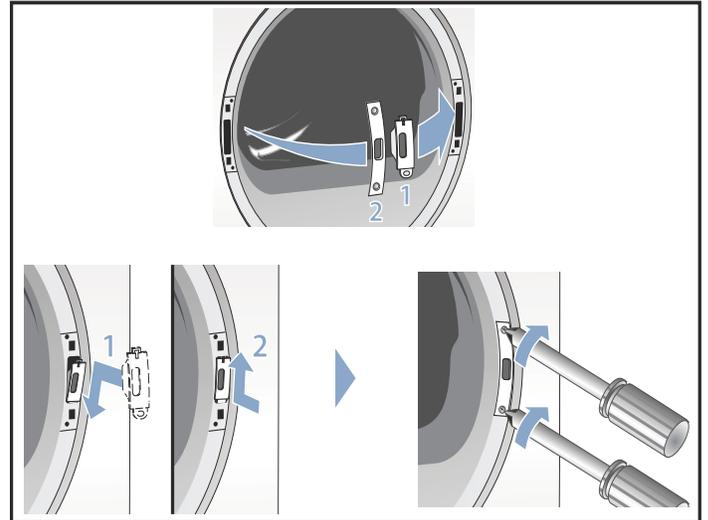

13. Screw the door to the dryer.

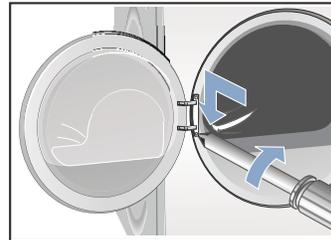

14. You can now put in the power supply plug and close the door to start operating the dryer.

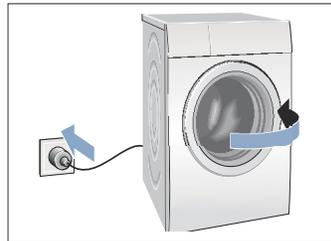

Getting to know your appliance

Control panel

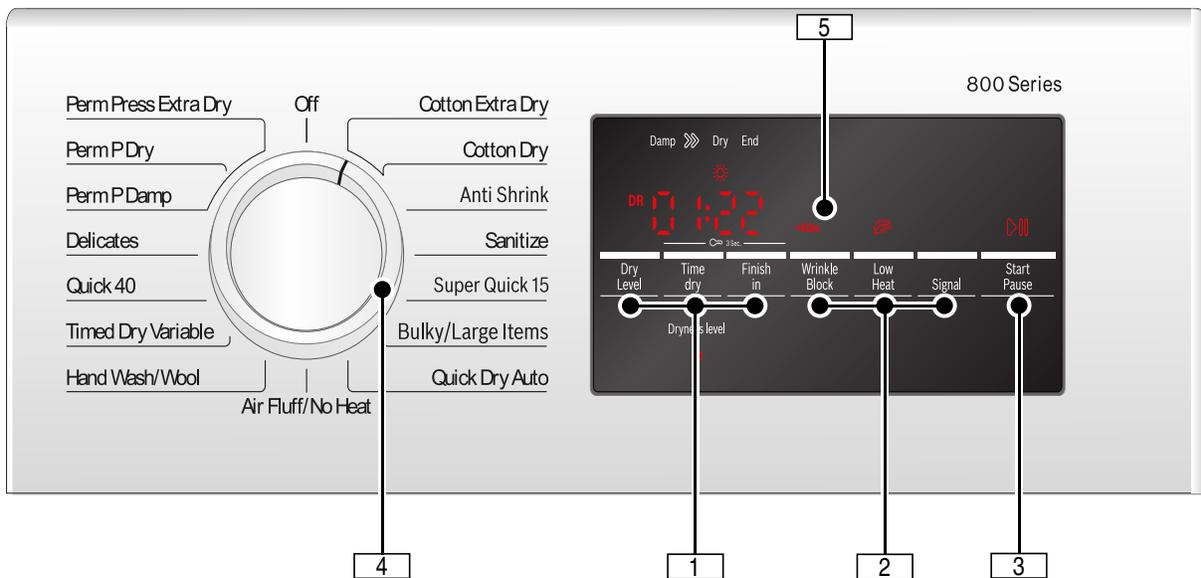

1 Dry Level, Time Dry, Finish in

Selectable Option Settings for customizing Programs as desired.
Indicator Symbol lights or desired time is displayed if setting is active. → *Default Program and Option settings; Page 27*

4 Program Selector

Selecting a program and switching on/off; turns in both directions.

2 Wrinkle Block, Low Heat, Signal

Additional option settings.
Indicator Symbol lights if setting is active. → *Additional Program Option settings; Page 27*

5 Display area for settings and information.

3 Start/Pause

- starts or pauses the selected cycle;
- indicator lamp on (steady) - cycle running, can be paused;
- indicator lamp blinking - options can be changed; cycle can be started; door is closed; childproof lock is active; cycle is in Pause mode.

Operating Instructions

▲ WARNING

RISK OF FIRE, ELECTRIC SHOCK, OR INJURY
To reduce the risk of fire, electric shock, or injury to persons, read the IMPORTANT SAFETY INSTRUCTIONS and Operating Instructions before operating this appliance.

Your new dryer

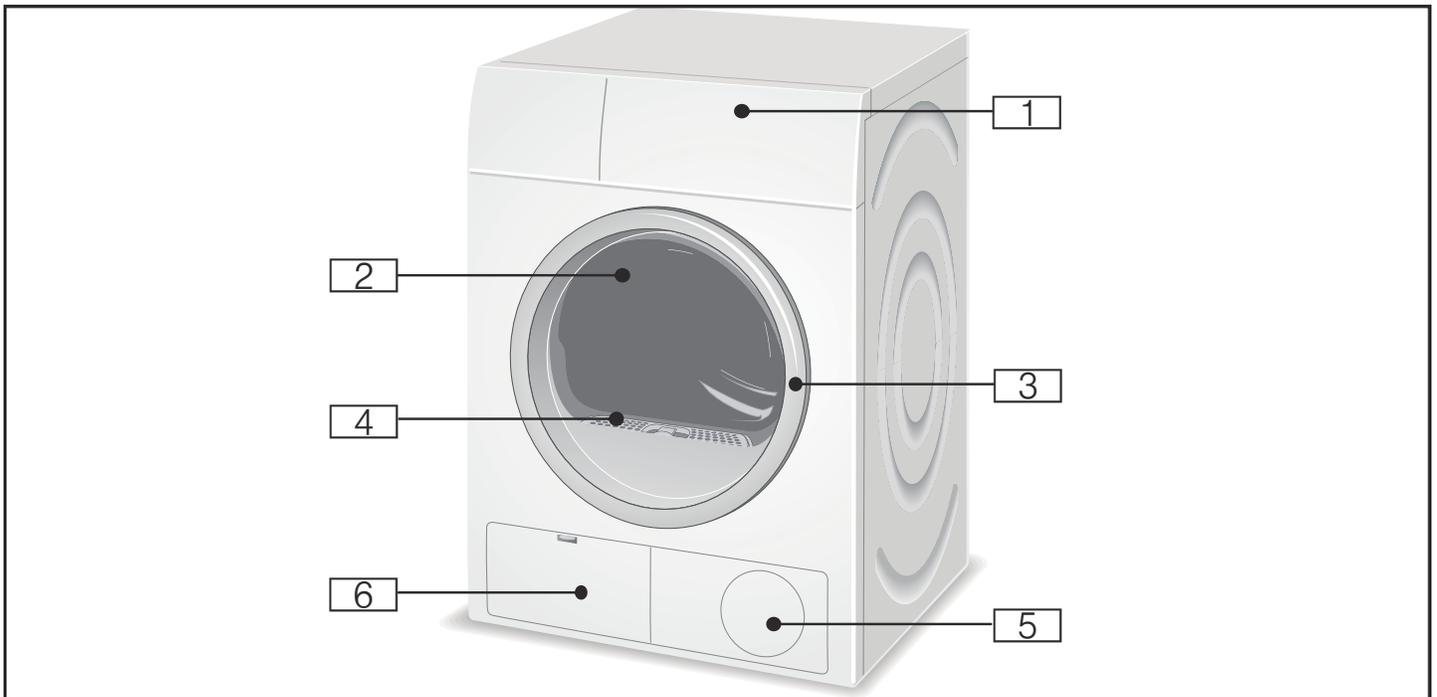

1 Control panel, display area, program selector

2 Drum with interior light (depending on model)

The interior light activates after the door is opened and after the program starts, it switches off automatically.

3 Open the door

Close the door

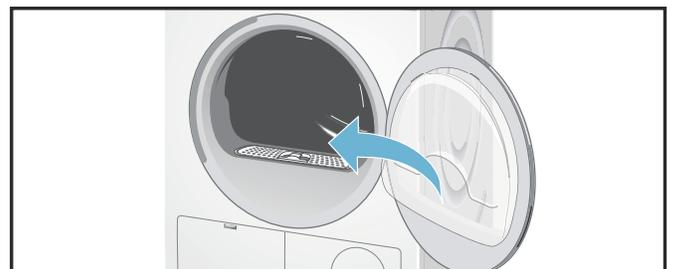
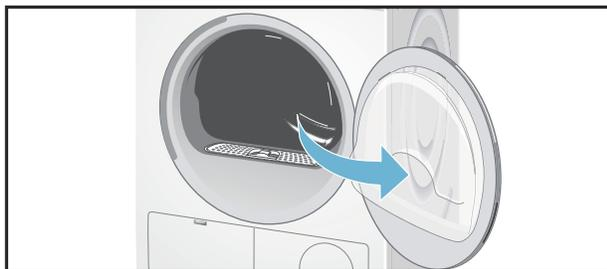

4 Lint filter

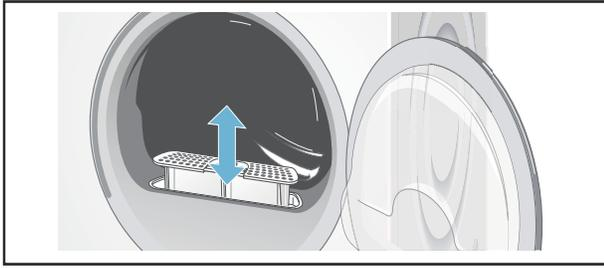

5 Air inlet

6 Open the maintenance flap

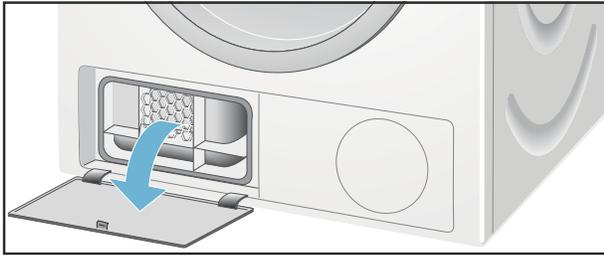

Heat exchanger

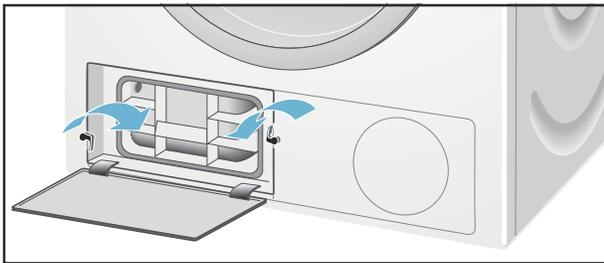

Close the maintenance flap

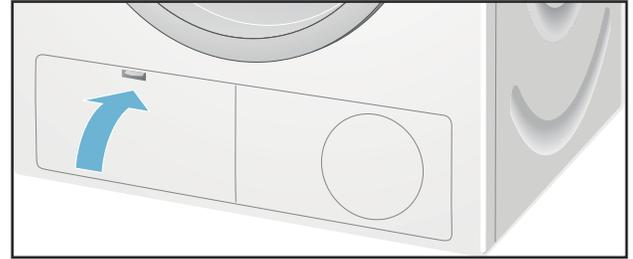

▲ WARNING

BEFORE INSTALLING OR USING YOUR DRYER
Read and follow all installation and operating instructions.

Check the machine. Never connect the utilities (power or water) to or start a damaged machine! Contact customer service!

→ *Customer service; Page 4*

Check to be sure the dryer drain hose is installed properly.

Turning the dryer on and off

The rotating Program Selector turns the dryer on as drying cycle is selected and off when the selector is later turned to the vertical **Off** position.

Before using the dryer for the first time

1. Read these operating instructions carefully.
2. Check that the supply voltage corresponds with the voltage specifications on the rating plate on the dryer, see top rear side of the dryer and/or rating plate label inside of the dryer door.
→ *Electrical Connections; Page 14*
3. Remove all objects from the drum.
machine on and when a drying cycle is selected the time

4. Check the dryer for visible damage. If damage found contact your dealer.
5. Wipe the inside of the drum with a damp cloth.
6. Check heating system.
→ *Check heating system; Page 16*
7. If the dryer does not work, switch the dryer to **Off**. Look in the Troubleshooting section of the operating instructions for support.
→ *Troubleshooting; Page 31*

Temporary disconnection of the dryer

Operate your dryer only when you are at home. If you intend going on vacation or are not using your dryer for an extended period of time, you should:

1. Turn off the circuit breaker.
2. Pull out the power supply plug if possible.
3. Clean the lint filter.

Using the program selector to choose a drying cycle

NOTICE: If you have activated the childproof lock, you must deactivate it before you can set a program.
→ *Childproof lock; Page 24*

Use the program selector to select the desired drying cycle. This dial turns in both directions, switches the duration appears in the display.

Program selection

For optimum drying results your dryer offers several program groups and additional options.

Select the required drying program from the program table according to the examples.

→ *Program selection table; Page 26*

Automatic programs

There are automatic programs for different types of textiles (regular/cotton, permanent press).

The program sequence of automatic programs is controlled by sensors. The duration of the program depends on the measured degree of moisture in the laundry and on the selected degree of dryness (e.g. Cotton Dry or Cotton Extra Dry).

- Regular/Cotton

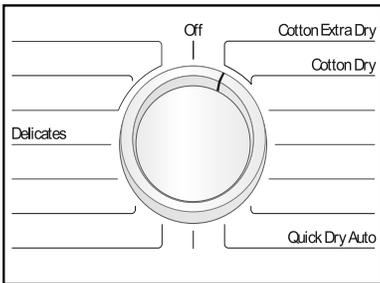

- Permanent Press

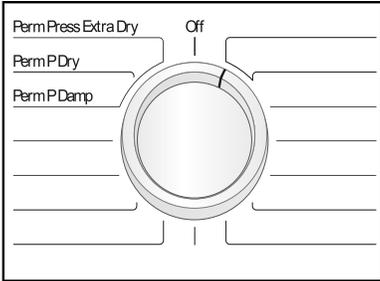

Special programs

The programs Sanitize, Jeans, Anti Shrink, Super Quick 15, Towels, Bulky/Large Items and Heavy Duty (depending on model) are made for special type fabric loads.

→ *Program selection table; Page 26*

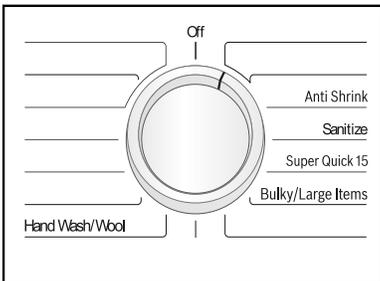

Time programs

Time programs run at specific temperatures. Suitable for pre-dried, multi-ply, delicate textiles or individual small items. Also for subsequent drying.

→ *Default Program and Option settings; Page 27*

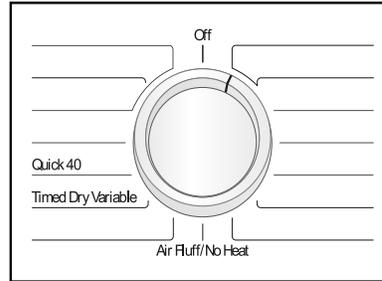

Selecting program settings and additional options

By selecting program settings and additional options, you can adjust the drying process to better suit the items you are drying.

The settings can be selected and deselected depending on the cycle progress.

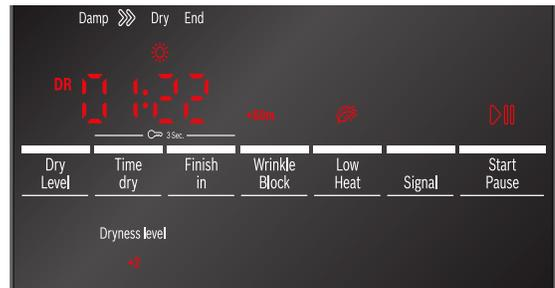

The indicator lamps of the buttons light up if the setting is active.

For **Time Dry**, **Finish in**, **Wrinkle Block**, **Low Heat** and **Signal** the settings are not retained after the appliance is switched off.

→ *Default Program and Option settings; Page 27*

→ *Additional Program Option settings; Page 27*

For **Dry Level** the setting is retained after the appliance is switched off.

→ *Dry Level; Page 27*

Loading the laundry

▲ WARNING

RISK OF EXPLOSION

Do not dry laundry that has ever been in contact with solvents, oil, wax, grease or paint (e.g. hair styling products, nail varnish remover, stain remover, cleaning solvent, etc.).

1. Check lint filter.

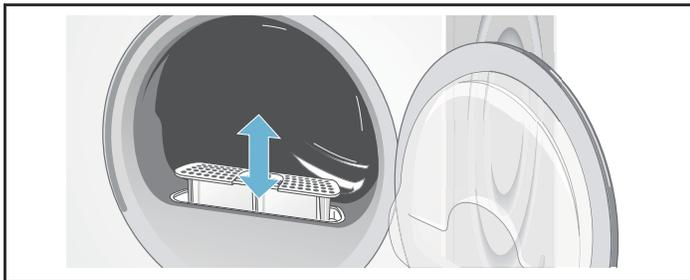

The filter should be cleaned after or before every drying process. Cleaning the filter reduces the drying time and saves energy.

→ *Cleaning the lint filter; Page 28*

2. Load the laundry into the drum and close the door.

Tip: If the door has not been closed properly, the dryer will not start.

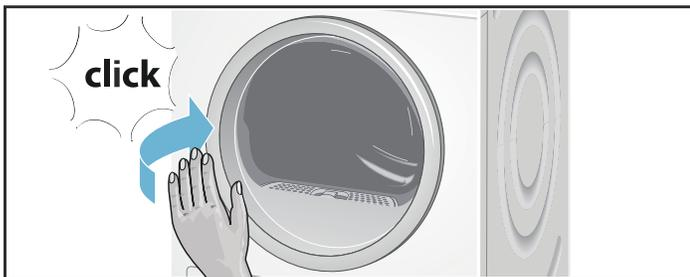

Tips

After loading, close the door carefully so as not to trap any items between the door and the rubber seal. The door should close until a click is heard.

Foreign objects left in the drum may damage laundry. Before inserting any laundry, check to make sure no foreign objects are in the drum.

Recommended Load Size

Recommended maximum load size can be found in the program selection table in this manual.

→ *Program selection table; Page 26*

Load the laundry

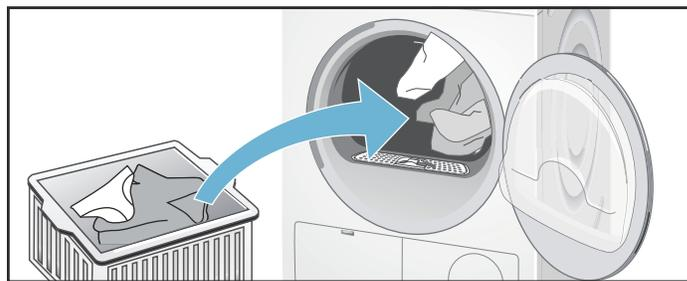

Place laundry in the empty drum. Put each piece of laundry into machine separately.

For best results the laundry to be dried must be sorted according to type of laundry and desired degree of drying.

→ *Program selection table; Page 26*

→ *Sorting the laundry; Page 25*

→ *Dry Level; Page 27*

Starting the program

1. Rotate program selector to the desired program.

Select the program which corresponds to the laundry in the dryer from Program selection table.

→ *Program selection table; Page 26*

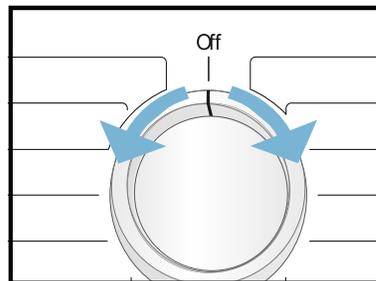

The **Start/Pause** indicator light starts flashing.

2. Touch the **Start/Pause** button. Indicator lamp lights up and the cycle starts.

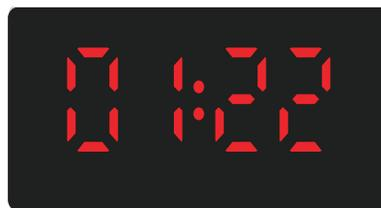

During the cycle, the display area indicates the estimated remaining time and, after starting the drying cycle, the cycle duration and the symbols for the cycle progress are flashing.

NOTICES

- If you want to protect the cycle against inadvertent adjustment, select the **Childproof lock**.
→ *Childproof lock; Page 24*
- If  indicator lights up, clean the lint filter and/or heat exchanger.
→ *Cleaning the lint filter; Page 28*
→ *Cleaning the heat exchanger; Page 29*

- If **DR** indicator lights up, check the drain hose and its connection.
→ *Maintenance of drain hose; Page 30*
- 3. If required, select **Low Heat** by pressing the button.
→ *Additional Program Option settings; Page 27*
- 4. If required, select **Wrinkle Block** by pressing the button.
→ *Additional Program Option settings; Page 27*

Tip: The estimated remaining time will be updated.

Indicator of program sequence

Bosch dryers use an advanced control system with a moisture sensor continually monitoring the laundry's remaining moisture.

The current state of the process and status of the program is shown by indicator lights (Damp, \gg , Dry, End).

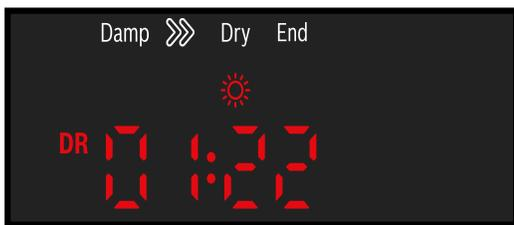

Childproof lock

You can secure the dryer against inadvertent changing of the set functions. To do this, activate the childproof lock after cycle start.

To **Activate/Deactivate**, touch Time Dry and Finish in buttons at the same time for 3 seconds. In the display field, you will see the C symbol light indicating the childproof lock is active.

NOTICE: The childproof lock will remain activated until the next cycle start even after switching the machine off. You must deactivate the childproof lock before the next cycle and, if necessary, activate it again after starting the cycle.

Signal

For switching the buzzer on and off touch the **Signal** button.

The buzzer indicates program end if it is activated. Other alarms are not influenced by this option.

You can also change the following settings:

- volume for buzzer
- volume for button signals

To change these settings always activate adjustment mode first.

Selecting a different program

If you have inadvertently started the wrong program, you can change this as follows:

1. Touch Start/**Pause**.
2. Select another program.
3. Touch **Start/Pause**. The new drying cycle starts from the beginning.

Cancel program

If required, you can cancel the selected program:

1. Touch Start/**Pause**.
2. Rotate the program selector to **Off**.

Program end



End appears in the display area and the Start/Pause button indicator lamp is off.

After the program end, rotate the program selector to **Off**.

Removing laundry/switching the appliance off

1. Open the door and remove the laundry.
2. Turn the program selector to the **Off** position.
Appliance is switched off and dryer light goes out.
3. Clean lint filter.
→ *Cleaning the lint filter; Page 28*
4. Close the door.

Tip: If at the end of the drying cycle the display does not light, the energy-saving mode is active. To see display, e.g. press any button.

→ *Environmentally friendly use of your dryer; Page 7*

Activate adjustment mode

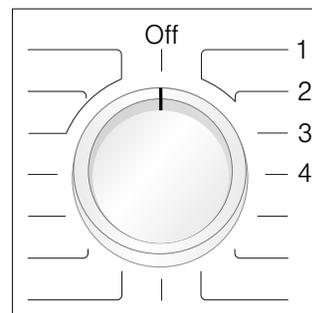

1. Select **Cotton Extra Dry** on position 1.

The appliance is on.

2. Hold down **Start/Pause** and turn the program selector to the right (position 3). Release **Start/Pause** button.

Adjustment mode is now activated and the default volume for buzzer appears in the display.

Changing the volume

You can set the volume by touching the **Time Dry** (volume up) or **Finish in** (volume down) button with the program selector in the following positions:

- Position 3 for buzzer volume



0 = off, 1 = soft,
2 = mid, 3 = loud,
4 = very loud

- Position 4 for button signals volume



0 = off, 1 = soft,
2 = mid, 3 = loud,
4 = very loud

Quit adjustment mode

Turn the program selector to **Off** position. The settings were saved.

Laundry

Preparing the laundry

NOTICE: Damage to the appliance/fabrics.

Foreign objects (e.g. coins, paper-clips, needles, nails) may damage the laundry or components in the dryer.

Therefore, note the following tips when preparing your laundry:

- Empty all pockets to ensure no loose debris (coins, keys, other hard objects and cigarette lighters) are placed in the dryer drum. The drum must be empty prior to drying.

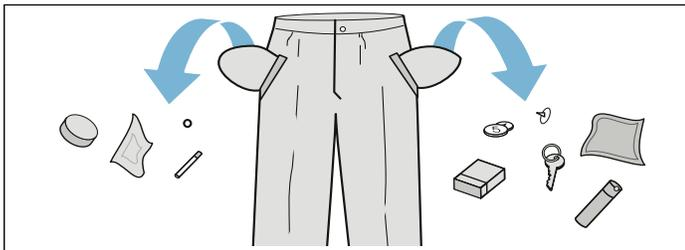

- Close any fasteners (such as zippers, hooks and eyelets) that could cause laundry to catch or become entangled. Button up covers. Tie cloth belts, apron strings, etc. together or use a laundry bag.
- Remove any foreign objects or non-washable parts.
- Always dry very small items (such as socks and handkerchiefs) and underwired bras together with large items of laundry or in a laundry bag.

Sorting the laundry

Check the care labels on each laundry item prior to drying. They provide valuable information as well as limitations about the temperature of drying process. Choose an appropriate drying cycle.

Do not dry the following textiles in the dryer:

- air-tight textiles (e.g. rubberized),

- delicate fabrics (silk, synthetic curtains).

Drying tips

- To ensure a uniform drying result, sort the laundry according to fabric type and drying program.
- Do not over-dry easy-care laundry - risk of wrinkling! Allow laundry to finish drying in the air.
- Do not iron laundry immediately after drying. Place the laundry in a pile for a short while. Residual moisture will then be distributed uniformly.
- Knitted fabrics (e.g. T-shirts, jerseys) often shrink when tumble-dried for the first time. Do not use the **Extra Dry** program.
- Only dry wool fabrics with the use of drying rack. To refresh or fluff up wool articles use the **Hand Wash/Wool** program and remove load from dryer and layout on flat surface to finish drying.
- Starched laundry is not always suitable for dryer. Starch leaves behind a coating that reduces the drying effect.
- When washing laundry that is to be tumble-dried afterwards, use the correct amount of fabric softener as specified in the manufacturer's instructions.
- For pre-dried, multi-layered fabrics or small, individual items of laundry, use the **Time** program.
→ *Program selection table; Page 26*
Also suitable for subsequent drying.

Program selection table

Programs	Max. load up to:	Type of laundry (For laundry which is:)
Standard programs		
Cotton Dry	full load	Normal cotton and linen type load (bed linen, cotton clothes, etc.)
Cotton Extra Dry	full load	Terry bathrobes and terry bed linen (particularly thick or multi-ply)
Perm P Damp	1/2 load	Trousers, dresses, skirts, shirts, blouses, leggings, sports clothing with synthetic-rich fibers, lingerie (not to be or only lightly ironed)
Perm P Dry	1/2 load	Shirts, blouses, sports clothing (not to be ironed)
Perm Press Extra Dry	1/2 load	Bed linen and table linen, track suits, paraks, blankets (not to be ironed, thick or multi-ply)
Delicates	1/4 load	Lingerie made of synthetic fibers, cotton or blended fabric
Quick 40	1/3 load	Multi-layered, sensitive fabrics made of acrylic fibers or separate small items of laundry also for subsequent drying
Time Dry Variable	1/3 load	Pre-dried, multi-layered, sensitive fabrics made of acrylic fibers or separate small items of laundry also for subsequent drying
Hand Wash/Wool	1/3 load	Wool fabrics suitable for washing used to refresh or fluff up wool articles but not dry completely remove fabrics after program end, lay on flat surface and allow to dry
Air Fluff/No Heat	1/3 load	All type of fabrics for freshing up or airing of items of laundry that have been worn for a short period of time
Quick Dry Auto	1/4 load	Laundry made of synthetic fibers, cotton or blended fabrics (for example) that needs to be dried quickly Values may differ from those specified depending on the type of fabric, mixture of laundry to be dried and residual moisture in the fabric
Special programs		
Anti Shrink	1/3 load	Cotton or linen fabrics and easy-care textiles which are still damp creases in textiles are reduced textiles are not completely dried - hang up textiles!
Sanitize	1/2 load	cotton fabrics for drying in higher temperatures to keep them more hygienic
Super Quick 15	1/4 load	For optimal drying a maximum of 5 business shirts after drying, iron or hang up the remaining moisture will be evenly distributed
Bulky/Large Items	full load	Garments with down feather fillings, pillows and blankets but not quilts only dry one article at a time

Tip: For best results it is recommended to load the drum depending on the fabric type:

- full load: Cottons and Linens
- 1/2 load: Permanent Press, Synthetic Blends and Poly Knits
- 1/3 load: Wool, Mixed
- 1/4 load: Delicates

Default Program and Option settings

At the factory initial settings are pre-set for all cycles. You can change some program settings as follows.

Dry Level

The dryness level can be increased in 3 steps (i.e. the laundry is drier) by touching the **Dry level** button for certain programs.

Default setting = 0 (No LED Symbol shown)

Selectable values: 0, +1, +2, +3

After the dryness level for a program is set, it is retained until changed again.

Time Dry

Available only for Time programs,

→ *Program selection table; Page 26*

can be selected from minimum 20 minutes to maximum 3 hours, in 10-minute steps.

Finish in

The program end (Finish in) time can be set in one hour increments to a maximum of 24 h (hours).

After selecting the desired drying program (at the dial) but before touching the Start button, touch the **Finish in** button until the desired time is displayed, e.g. 8 h, then touch the Start button to start the dryer.

NOTICE: The cycle duration is included in the set Finish in time.

Here is an example of 2hr:30 min cycle time and an **8 h** Finish in time. **8 h** is displayed (until Energy-Saving mode activates) and counts down (approximately 5hr:30min) until the drying cycle begins (at 2hr:30min) then the cycle duration **2:30** is displayed and drying begins. Total time approximately 8 hours.

Additional Program Option settings

Wrinkle Block

To prevent the laundry from creasing or wrinkling, the dryer drum rotates at specific intervals following the drying process.

If the **Wrinkle Block** button is touched, this function is set to 60 (+60m) or 90 (+90m) minutes.

The laundry remains loose and fluffy until it is removed. The laundry should be removed before this time has elapsed.

Low Heat

Reduced temperature for delicate fabrics, e.g. polyacrylic, polyamide or elastane, with longer drying time.

Observe the care information or symbols on the textile's label.

Spin speed

The **Spin Speed** setting is based on your washer's normal spin speed. Adjusting this setting allows the dryer's displayed time to be as close as possible to the actual drying time.

NOTICE: The spin speed is not the same as the rotation speed of the dryer drum.

To change the dryer's **Spin Speed** setting follow the instructions below.

Activate adjustment mode

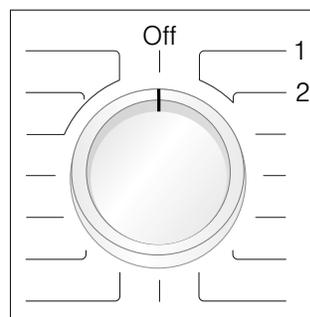

1. Select **Cotton Extra Dry** on position 1. The appliance is on.
2. Touch and hold **Start/Pause** and turn the program selector to the right (position 2). Release **Start/Pause** button. Adjustment mode is now activated and the default value (1000 rpm) appears in the display.

Change spin speed

Press the **Time Dry** or **Finish in** button to change the setting (allowable values are between 600 and 1800 in increments of 100).

Quit adjustment mode

Turn the program selector to **Off** position. The settings were saved.

Cleaning and care

USER-MAINTENANCE INSTRUCTIONS

▲ WARNING

RISK OF EXPLOSION

Never use solvents or highly flammable liquids for cleaning.

▲ CAUTION

Improper cleaning may damage the dryer or cause injury.

Do not spray with a hose or pressure washer.

Do not use scouring agents or all-purpose cleaners.

Do not use steam cleaners.

Do not use bleach-based wipes.

Cleaning the housing and control panel

Wipe the housing and fascia with a soft cloth and soapy water only.

Wipe the drum, door seal and inside of the door with a damp cloth only.

NOTICE: Do not clean with a water jet.

Remove detergent and cleaning agent residue immediately.

During drying, water may occasionally accumulate between the window and the seal. This does not affect the proper operation of your dryer.

Cleaning the lint filter

A dirty filter extends the drying time and increases energy consumption.

The filter should be cleaned before or after each drying process.

If  indicator lights up during a drying program, clean the filter immediately.

Tip: The program interrupts automatically.

To clean the lint filter:

1. Switch off the dryer. Rotate the program selector to **Off**.

▲ CAUTION

The inside of the door heats up during the drying process. The drum, the door and the laundry may be hot.

2. Open the door.

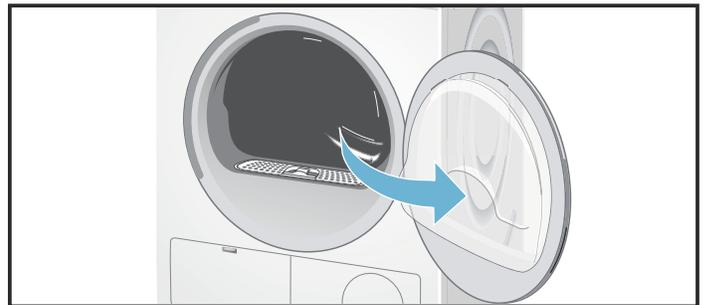

3. Pull out filter.

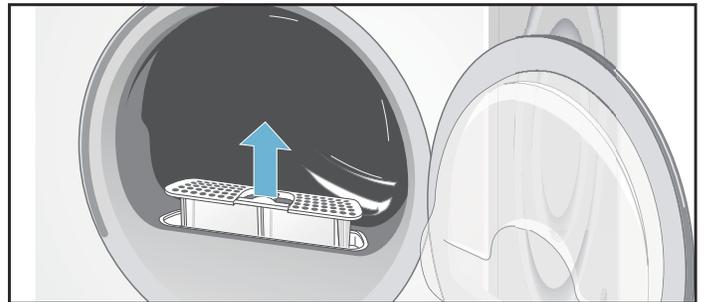

4. Open the filter.

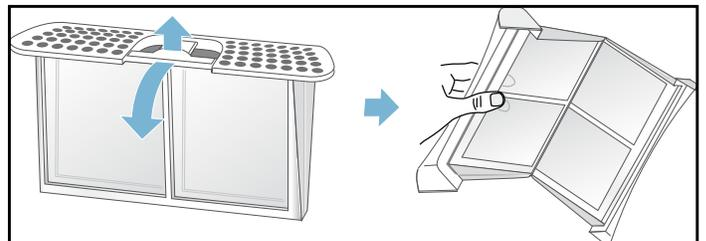

5. Remove fluff (run hand over filter).

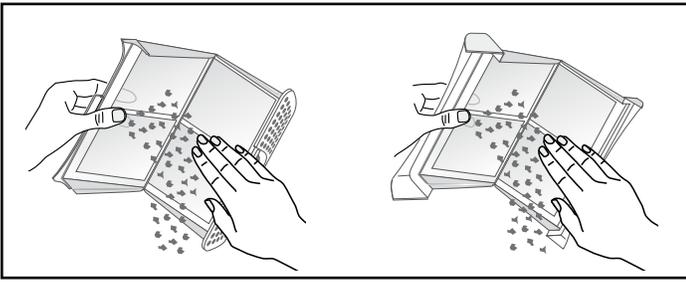

6. Close the filter and re-insert it.

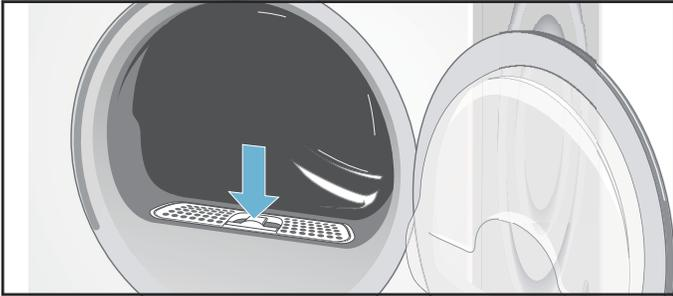

7. Close the door.

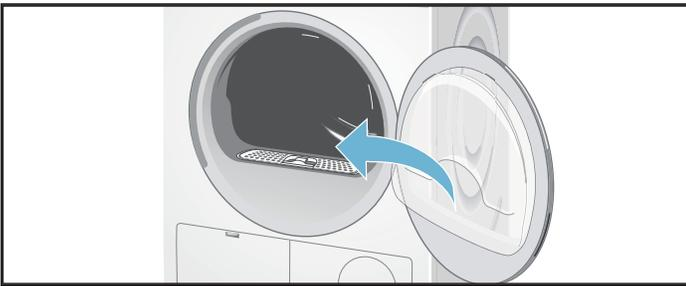

NOTICE: Severely dirty or clogged lint filter should be rinsed under warm running water.

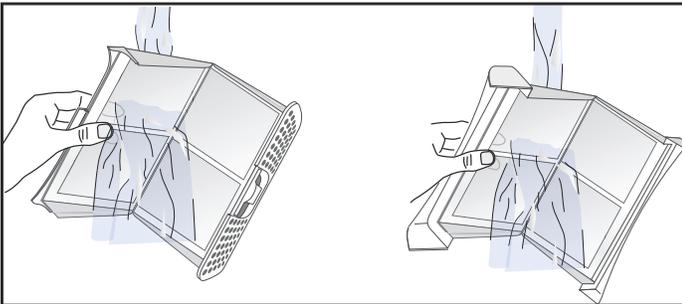

The filter must be dried thoroughly before being placed back into dryer.

Cleaning the heat exchanger

The heat exchanger requires periodic cleaning (recommended once per month under normal drying conditions). The frequency of cleaning depends on the amount and type loads being dried.

To clean the heat exchanger:

1. If the dryer is hot, run on **Air Fluff/No Heat** program to allow the dryer to cool down.
2. Residual water may escape, place an absorbent cloth under the maintenance flap.
3. Unlock the maintenance flap and open it completely.

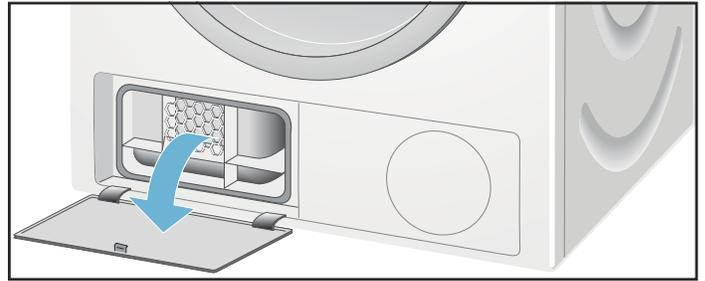

4. Turn both locking levers towards each other.

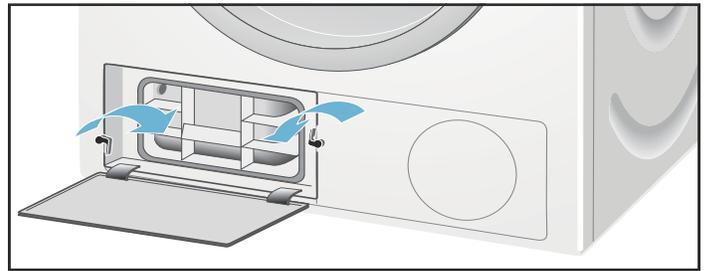

5. Pull out the heat exchanger cap.

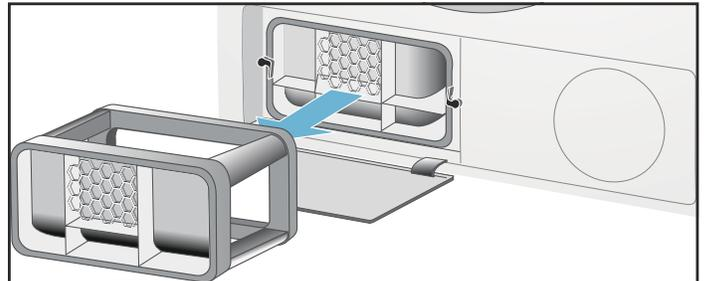

6. Remove the heat exchanger.

NOTICE: Do not damage the heat exchanger! Clean with warm water only. Do not use hard or sharp edged objects!

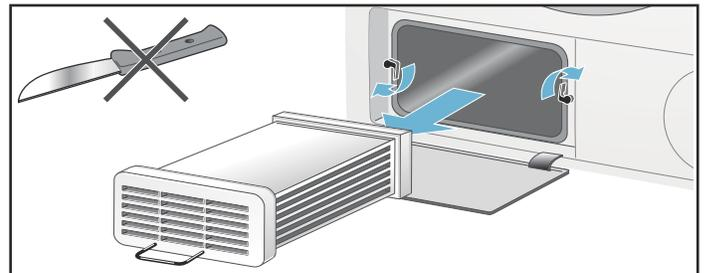

- Rinse the heat exchanger and the cap on all sides with a jet of water to completely remove all of the lint and fluff.

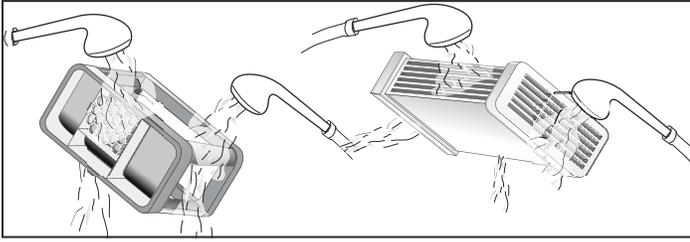

- Remove all lint and fluff from the seals on the dryer and heat exchanger.
- Allow the cap and the heat exchanger to dry fully.
- First insert the heat exchanger, then the cap.
- Turn back both locking levers.

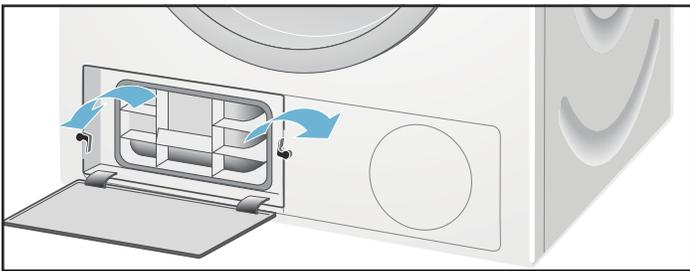

- Close the maintenance flap until it locks into position.

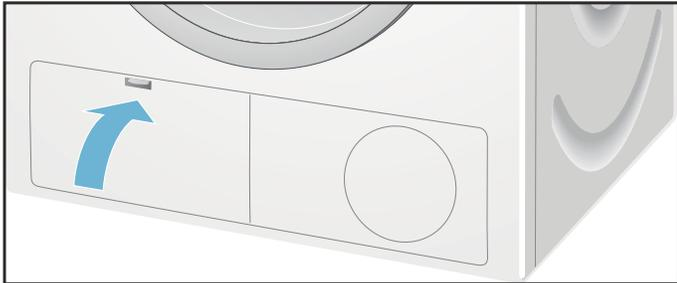

- Look in the Troubleshooting table to reset the maintenance indication.
→ *Troubleshooting; Page 31*

Cleaning the moisture sensors

Occasionally the moisture sensors have to be cleaned because a fine layer of transparent buildup is deposited on the sensors.

To clean the moisture sensors:

- Open the door.

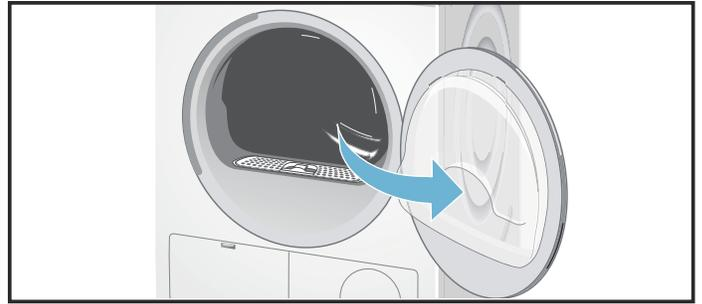

- The deposit on the sensors can easily be removed by wiping the sensors (the two bars next to the lint filter) with a cloth and a little white vinegar.

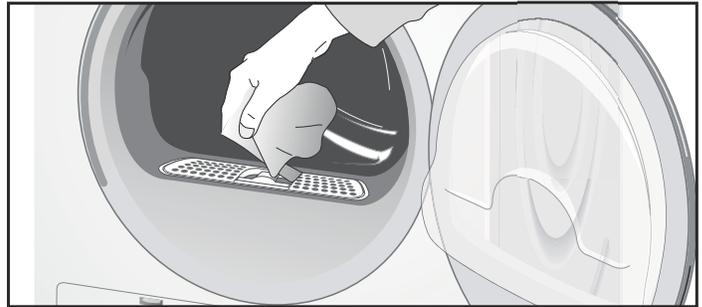

NOTICE: Use white vinegar only!
Clean the moisture sensors once a month.

Cleaning the lint filter area

Over time, lint from the drying process collects in the lint filter area.

This lint can be easily removed using a vacuum cleaner.

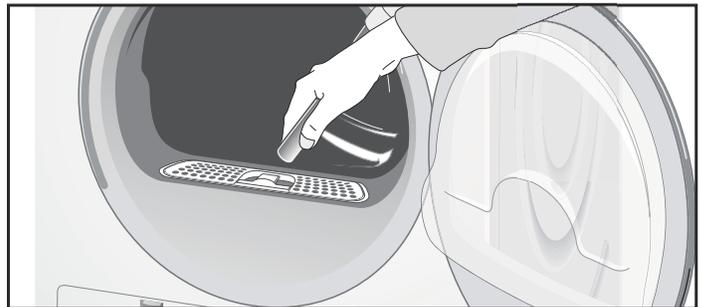

Maintenance of drain hose

If **DR** indicator lights up check the drain hose for kinks, restrictions or blockage.

NOTICE: If **DR** indicator still lights up after the maintenance, you should contact customer service or your local dealer.

Troubleshooting

Introduction

NOTICE: Before doing maintenance work or trying to fix a problem, rotate the program selector to **Off**.

The program will not continue running when the power supply has been restored. Desired program must be selected again and start button pressed.

▲ WARNING

RISK OF INJURY TO SKIN
The door, the drum and the laundry may be hot.

▲ WARNING

RISK OF ELECTRIC SHOCK! EXPLOSION HAZARD
Repairs or replacement of parts should be carried out by authorized technicians only.

Determining the Problem

Problem	Possible cause(s)	Solution(s)
Dryer does not start. Start/Pause indicator light does not illuminate.	Power cord end not inserted at all or not inserted correctly.	Insert power cord end correctly.
	A fuse is blown or breaker is tripped.	Replace fuse or reset breaker.
	Start/Pause button not touched.	Touch Start/Pause button.
	Door not closed properly.	Check if laundry is caught in the door. Close the door until a click is heard.
	Program not selected.	Rotate the program selector to desired program. → <i>Program selection table; Page 26</i>
The display panel and indicator lights go out, Start/Pause indicator light flashes.	Energy-saving mode is activated.	Touch any button to activate the display. → <i>Environmentally friendly use of your dryer; Page 7</i>
The display panel switches off.	Sleep mode after setting the Finish in option is activated.	Touch any button to activate the display.
☰ indicator light up.	Lint filter dirty.	Clean lint filter. → <i>Cleaning the lint filter; Page 28</i> Touch the Start/Pause button to reset the displayed indication and then touch Start/Pause button again to reset the appliance if necessary.
	Heat exchanger dirty.	Clean heat exchanger. → <i>Cleaning the heat exchanger; Page 29</i> Touch the Start/Pause button to reset the displayed indication and then touch Start/Pause button again to reset the appliance if necessary.
DR indicator light up. Water has not drained completely.	Drain hose is blocked.	Check drain hose. → <i>Maintenance of drain hose; Page 30</i> Check drain hose connection conditions.

Before calling customer service, check whether you can rectify the fault yourself by means of the following table.

If a fault cannot be rectified or a repair is required:

1. Set program selector to **Off**.
2. Disconnect the dryer from the power outlet.
3. Call customer service.
→ *Customer service; Page 4*

General Troubleshooting

Often when you encounter a problem it will be something minor. Before you call customer service, consider the suggestions and instructions below:

NOTICE: The troubleshooting items listed below can help you resolve minor issues with your dryer quickly and without the necessity of waiting for a service call.

Service calls for issues that could have been resolved by using this table may not be covered under the Warranty. Please rule out any of these issues before calling customer service.

Problem	Possible cause(s)	Solution(s)
Water is leaking out.	Dryer is not leveled.	Level the dryer. → <i>Leveling the dryer; Page 16</i>
	The heat exchanger seal is dirty.	Clean the heat exchanger seal. → <i>Cleaning the heat exchanger; Page 29</i>
	Drain hose is leaking.	Check entire length of drain hose for leaks; replace if necessary. Check that hose is clamped on hose barb at back of the dryer securely.
Program terminates shortly after starting.	Laundry is not loaded.	Load the laundry. → <i>Loading the laundry; Page 23</i>
	Load too small for selected program.	Use time program. → <i>Program selection table; Page 26</i>
	Loaded laundry is too dry.	Check the loaded laundry. If it is dry, open the door, remove laundry and turn program selector to Off .
The door opens by itself.	The door not closed properly.	Close the door until a click is heard.
Creasing.	Laundry load exceeded.	Do not exceed the maximum load for selected program. Remove items of laundry immediately after the end of the program, hang them up and pull into shape. Turn program selector to Off . → <i>Program selection table; Page 26</i>
	Unsuitable program selected.	
Drying result is not satisfactory (laundry feels too damp).	Warm laundry may feel more damp than it really is.	Remove items of laundry immediately after the end of the program and turn the program selector to Off .
	The selected program does not suit the load.	Use another drying program or, in addition, select the time program. → <i>Program selection table; Page 26</i>
	Dryness level is not adjusted.	Use Dry Level to adjust the dryness level. → <i>Dry Level; Page 27</i>
	Fine layer of limescale on the moisture sensors.	Clean the moisture sensors. → <i>Cleaning the moisture sensors; Page 30</i>
	Program termination e.g. main power supply failure, door open or maximum drying time reached.	See the problem(s) mentioned in this table.
	Initial load is too wet.	Spin laundry at higher speed in the washing machine, before drying. Switch off the dryer, and than turn it on again.
Drying time too long.	Lint filter and/or Heat Exchanger is dirty.	Clean lint filter → <i>Cleaning the lint filter; Page 28</i> and/or Heat Exchanger. → <i>Cleaning the heat exchanger; Page 29</i>
	Insufficient supply of air.	Ensure that air can circulate.
	Air inlet possibly blocked.	Do not obstruct the air inlet on the front of the dryer.
	Ambient temperature higher than 95°F/35°C.	Ventilate the room.
Program does not start Finish in (remaining) time is displayed.	A delayed starting time has been selected and activated.	Drying cycle will begin at proper time to complete at the selected Finish in time.
Program does not start -  symbol lit up.	Childproof lock is activated.	Deactivate Childproof lock. → <i>Childproof lock; Page 24</i>

Problem	Possible cause(s)	Solution(s)
One or more indicator lights are flashing.	Lint filter or/and heat exchanger is dirty.	Clean lint filter or/and heat exchanger (see solution of the problem(s) in this table above).
	Installation conditions are not adequate.	Check the installation conditions. → <i>Electrical Connections; Page 14</i>
	Fault in program sequence or malfunction.	Switch off the dryer, allow it to cool down, switch back on and restart the program.
Power failure.		Remove laundry from the dryer immediately and spread out. This allows the heat to dissipate. Be careful as the door, the drum and the laundry may be hot.

STATEMENT OF LIMITED PRODUCT WARRANTY

Bosch Clothes Dryer

What this Warranty Covers & Who it Applies to:

The limited warranty provided by BSH Home Appliances (“Bosch”) in this Statement of Limited Product Warranty applies only to the Bosch appliance sold to you, the first using purchaser, provided that the Product was purchased:

- For your normal, household (non-commercial) use, and has in fact at all times only been used for normal household purposes.
- New at retail (not a display, “as is”, or previously returned model), and not for resale, or commercial use.
- Within the United States or Canada, and has at all times remained within the country of original purchase.

The warranties stated herein apply only to the first purchaser of the Product and are not transferable.

Please make sure to return your registration card; while not necessary to effectuate warranty coverage, it is the best way for Bosch to notify you in the unlikely event of a safety notice or product recall.

Limitation for Third Party Accessories:

Third party accessories, other than those shipped with your Bosch appliance, and any consequential damages resulting therefrom, are not covered by this warranty. This limitation expressly includes the implied warranties of merchantability and fitness for a particular purpose, which are also expressly excluded with respect to third party accessories, other than those shipped with your Bosch appliance. Use of third party accessories, other than those shipped with your Bosch appliance, does not void this warranty on any other part, and all other provisions of this warranty remain in effect.

How Long the Warranty Lasts:

Bosch warrants that the Product is free from defects in materials and workmanship for a period of three hundred sixty-five days (365) days from the date of purchase. The foregoing timeline begins to run upon the date of purchase, and shall not be stalled, tolled, extended, or suspended, for any reason whatsoever. This product is also warranted to be free from cosmetic defects in material and workmanship (such as scratches of stainless steel, paint/porcelain blemishes, chips, dents,

or other damage to the finish) of the Product, for a period of thirty (30) days from the date of purchase or closing date for new construction. This cosmetic warranty excludes slight color variations due to inherent differences in painted and porcelain parts, as well as differences caused by kitchen lighting, product location, or other similar factors. This cosmetic warranty specifically excludes any display, floor, “As Is”, or “B” stock appliances.

Repair/Replace as Your Exclusive Remedy:

During this warranty period, Bosch or one of its authorized service providers will repair your Product without charge to you (subject to certain limitations stated herein) if your Product proves to have been manufactured with a defect in materials or workmanship. If reasonable attempts to repair the Product have been made without success, then Bosch will replace your Product (upgraded models may be available to you, in Bosch’s sole discretion, for an additional charge). All removed parts and components shall become property of Bosch at its sole option. All replaced and/or repaired parts shall assume the identity of the original part for purposes of this warranty and this warranty shall not to be extended with respect to such parts. Bosch’s sole liability and responsibility hereunder is to repair manufacturer-defective Product only, using a Bosch authorized service provider during normal business hours. For safety and property damage concerns, Bosch highly recommends that you do not attempt to repair the Product yourself, or use an un-authorized servicer; Bosch will have no responsibility or liability for repairs or work performed by a non-authorized servicer. If you choose to have someone other than an authorized service provider work on your Product, THIS WARRANTY WILL AUTOMATICALLY BECOME NULL AND VOID.

Authorized service providers are those persons or companies that have been specially trained on Bosch products, and who possess, in Bosch’s opinion, a superior reputation for customer service and technical ability (note that they are independent entities and are not agents, partners, affiliates or representatives of Bosch). Notwithstanding the foregoing, Bosch will not incur any liability, or have responsibility, for the Product if it is located in a remote area (more than 100 miles from an authorized service provider) or is in a reasonably inaccessible, hazardous, threatening, or treacherous

locale, surroundings, or environment; in any such event, if you request, Bosch would still pay for labor and parts and ship the parts to the nearest authorized service provider, but you would still be fully liable and responsible for any travel time or other special charges by the service company, assuming they agree to make the service call.

SCOPE OF EXTENDED LIMITED WARRANTY

Bosch will repair or replace, free of charge, any printed circuit boards, drive motor or component part of the drive motor that proves defective under conditions of normal home use during the first seven hundred thirty (730) days from the date of purchase, labor charges excluded.

Out of Warranty Product:

Bosch is under no obligation, at law or otherwise, to provide you with any concessions, including repairs, prorates, or Product replacement, once this warranty has expired.

Warranty Exclusions:

The warranty coverage described herein excludes all defects or damage that are not the direct fault of Bosch, including without limitation, one or more of the following:

- Use of the Product in anything other than its normal, customary and intended manner (including without limitation, any form of commercial use, use or storage of an indoor product outdoors, use of the Product in conjunction with air or water-going vessels).
- Any party's willful misconduct, negligence, misuse, abuse, accidents, neglect, improper operation, failure to maintain, improper or negligent installation, tampering, failure to follow operating instructions, mishandling, unauthorized service (including self performed "fixing" or exploration of the appliance's internal workings).
- Adjustment, alteration or modification of any kind.
- A failure to comply with any applicable state, local, city, or county electrical, plumbing and/or building codes, regulations, or laws, including failure to install the product in strict conformity with local fire and building codes and regulations.
- Ordinary wear and tear, spills of food, liquid, grease accumulations, or other substances that accumulate on, in, or around the Product.
- Any external, elemental and/or environmental forces and factors, including without limitation, rain, wind, sand, floods, fires, mud slides, freezing temperatures, excessive moisture or extended exposure to humidity, lightning, power surges, structural failures surrounding the appliance, and acts of God.

In no event shall Bosch have any liability or responsibility whatsoever for damage to surrounding property, including cabinetry, floors, ceilings, and other structures or objects around the Product. Also excluded from this warranty are Products on which the serial numbers have been altered, defected, or removed; service visits to teach you how to use the Product, or visits where there is nothing wrong with the Product; correction of installation problems (you are solely responsible for any structure and setting the Product, including all electrical, plumbing

or other connecting facilities, for proper foundation/flooring, and for any alterations including without limitation cabinetry, walls, floors, shelving, etc.); and resetting of breakers or fuses.

TO EXTENT ALLOWED BY LAW, THIS WARRANTY SETS OUT YOUR EXCLUSIVE REMEDIES WITH RESPECT TO PRODUCT, WHETHER THE CLAIM ARISES IN CONTRACT OR TORT (INCLUDING STRICT LIABILITY, OR NEGLIGENCE) OR OTHERWISE. THIS WARRANTY IS IN LIEU OF ALL OTHER WARRANTIES WHETHER EXPRESS OR IMPLIED. ANY WARRANTY IMPLIED BY LAW, WHETHER FOR MERCHANTABILITY OR FITNESS FOR A PARTICULAR PURPOSE, OR OTHERWISE, SHALL BE EFFECTIVE ONLY FOR THE PERIOD THAT THIS EXPRESS LIMITED WARRANTY IS EFFECTIVE. IN NO EVENT WILL THE MANUFACTURER BE LIABLE FOR CONSEQUENTIAL, SPECIAL, INCIDENTAL, INDIRECT, "BUSINESS LOSS", AND/OR PUNITIVE DAMAGES, LOSSES, OR EXPENSES, INCLUDING WITHOUT LIMITATION TIME AWAY FROM WORK, HOTELS AND/OR RESTAURANT MEALS, REMODELLING EXPENSES IN EXCESS OF DIRECT DAMAGES WHICH ARE DEFINITELY CAUSED EXCLUSIVELY BY BOSCH, OR OTHERWISE. SOME STATES DO NOT ALLOW THE EXCLUSION OR LIMITATIONS ON HOW LONG AN IMPLIED WARRANTY LASTS, SO THE ABOVE LIMITATIONS MAY NOT APPLY TO YOU. THIS WARRANTY GIVES YOU SPECIFIC LEGAL RIGHTS, AND YOU MAY ALSO HAVE OTHER RIGHTS WHICH VARY FROM STATE TO STATE.

No attempt to alter, modify or amend this warranty shall be effective unless authorized in writing by an officer of BSH.

How to Obtain Warranty Service:

To obtain warranty service for your Product, you should contact Bosch Customer Service Department.

BSH Home Appliances Corporation - 1901 Main Street, Irvine, CA 92614 / 800-944-2904



9000991511
9501



BOSCH

1901 Main Street, Suite 600 • Irvine, CA 92614 • 1-800-944-2904
www.bosch-home.com • © 2012 BSH Home Appliances