

## Introduction and Intellectual Property Rights Statement

This product is designed to provide years of trouble-free services by using environment-friendly Solar-Hybrid-Lithium based energy technologies. Covered under US, European, China and other international patents granted and pending worldwide. All rights reserved.

The performance of this unit is highly related to its mounting location, direction of the solar panel, weather conditions and local environment. Therefore, to maximize the performance of the unit, read instruction carefully before installation. DIY user(s) must have knowledge of AC/DC electric/electronic projects and related construction/installation experiences. Otherwise, consult with local experienced electrical & electronics installers or technicians for assistance. Before installation, be aware of and comply with local construction laws, electrical code and life & safety standards/regulations that are applied for this lighting project. During installation, please follow proper safety guidelines to prevent any possible accidents or injuries.

## Easy Activation & One Step Setup (with factory default: 75% power for 4hrs then 25% of dimming with full power pull up motion mode)

This light unit is limited charged for shipping. Keep the light OFF status for pre-charging 1-2 days under sunny days before light up is highly recommended. The solar panel works as ambient light sensor to control the lighting system. **Press the Main Power Button** (latching type) on center of light body to turn on the light and activate the system (Fig.1&2; do not need to set up with remote control) for all night long auto-illumination in most lighting applications. During daytime testing, fully cover the solar panel with package box or cardboard to simulate nighttime environment. With eLEDing's Intelligent Power Management (IPM) system (Fig.4), the light offers Dusk-to-Dawn lighting and auto power compensation during critical weather and different geographic locations. During nighttime, the low ambient light level will trigger the light to provide all-night-long illumination based on preset lighting mode & lighting profile.

## Smart Lighting Profile with Remote Control (Press the Main Power Button to activate light before setting up via below chart and Fig. 4)

Based on user preset lighting mode & lighting profile. User tips for manually selectable lighting modes & profiles:

1. **Playground: Normal manually ON-OFF control - Press ON to illuminate, press 100% full max brightness, then press OFF once finish the play.**
2. **Fixed daily basis lighting mode without motion profile: Press ON, press M1, press 100% e.g., press 4H (hour) e.g. then it will light up automatically in every evening with set timing and brightness (note: decrease the brightness level setting can be extending more using hour up to 8H/8 hours).**
3. **Fixed lighting mode with motion of pulling up to max power profile (SMART mode): Press ON, press M2, press 4H e.g., press 75% e.g. for higher fixed brightness of 4 hours, then dim to fixed 25% of max brightness in rest of the quiet evening until dawn, with pull up to max brightness when sensor detects movement around.**
4. **Setup the lighting profile one by one if multiple units are used in the same project/area, but except for playground manually ON-OFF use.**

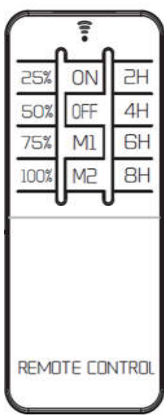

Battery Model for 2.4GHz Remote Control: A23, 12V

ON/OFF	Fixed Brightness Options	Delay Time Options	Standard Lighting Profile	Ideal Application	User Tips
Manually Turn ON/OFF	25%, 50%, 75%, 100%	N/A	Press ON to turn on the light Press OFF to turn off the light	Manually control the light in most sport court, pool, patio, open yard that used intermittently or occasionally	Private property HOA-managed recreational areas Pay-for-play facilities, etc.
<b>Mode 1 (M1)</b>	<b>Fixed Brightness Options</b>	<b>Delay Time Options</b>	<b>Dusk to Dawn Selectable Lighting Profile</b>	<b>Ideal Application</b>	<b>User Tips</b>
Motion Sensor Disabled	25%, 50%, 75%, 100%	2, 4, 6, 8 Hours	choose brightness and delay	Most sport courts, open space, loading zones, bus station, park, farm, parking lots operates under fixed daily schedule	Rich-sun season: 6-8 hrs delay time Poor-sun season: 2-4 hrs delay time
<b>Mode 2 (M2) Default Setting</b>	<b>Fixed Brightness Options</b>	<b>Delay Time Options</b>	<b>Dusk to Dawn SMART Lighting Profile</b>	<b>Ideal Application</b>	<b>User Tips</b>
Fixed Lighting Mode + Saving Sensing Mode	25%, 50%, 75%, 100%	2, 4, 6, 8 Hours	Light dim to 25% to saving mode after preset fixed lighting mode, and raise to full brightness when it detect motion (Fig.1)	Provide flexibility and power consumption adjustment under different seasons and weather conditions for parking lots, streets, pathway, trail, open yard e.g.	Most N.A. application: 75% & 4hrs Rich-sun season: Increase setting Poor-sun season: decrease setting

## Installation Guidelines (YouTube Video References: [www.eleding.com](http://www.eleding.com))

1. Follow above standard setup procedure to activate the lighting system (Fig.2)
2. Securely mount the unit on the light pole, adjust the light head direction based on your need (Fig.3)
3. The light will automatically shut down and charge during daytime sunshine condition (Fig.3)
4. Suggested Mounting Height: 15-38 ft (Fig.4)
5. Diameter of Mounting Adaptor: SHRC30 (2-1/2"); SHRC40 to SHRC100 (3-1/2"), refer Specification table (Page. 2)
6. Fixed light head angle to ground: 10-20 degrees by fixed MFC
7. **Solar Panel Direction:** The solar panel must be mounted in a non-obstructed position where it will receive an average of at least 5 hours daily direct sunlight all year round. For Northern hemisphere installations the solar panel can be mounted facing to East-South-West with direct southerly facing position is best and visa-versa for Southern hemisphere installation. As a option as required, AUX DC power sources can be use either for quickly charge light unit before installation, or/and for poor sunshine location or shadow position with AUX same size solar panel or back-up power source or as a charging enhancement method, refer Specification table (Page. 2)
8. **Solar Panel Maintenance:** Use a soft wet cloth to periodically (at least once a one year) clean the solar panel to avoid the reduction of energy output due to accumulated dust. Clean accumulated snow as soon as possible during the snowing season.

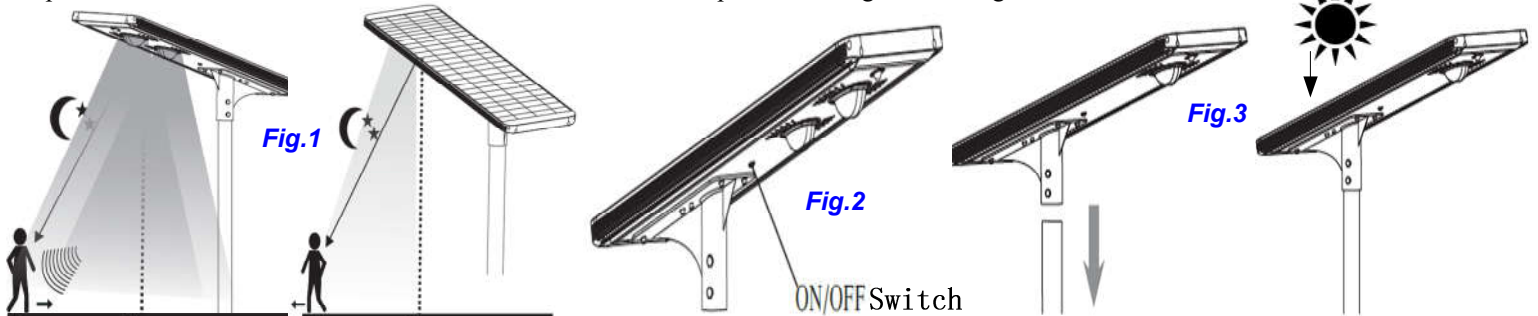

EE Systems Group Inc.

(Patented Technology)

# Installation Instruction

eLEDing® / EE800W-SHRC series  
Solar Ultra Powerful CREE-LED Area, Sport Court Lighting

eLEDing

22



SPECIFICATION	EE 840W-SHRC30	EE 850W-SHRC40	EE 860W-SHRC50	EE 870W-SHRC60	EE 880W-SHRC80	EE 880W-SHRC100
LED Illuminator (CREE, USA)	24PCs	36PCs	48PCs	6COB	8COB	10COB
LED Illuminating Wattage	30W	40W	50W	60W	80W	100W
Illumination (Lumen on peak), Color	3000+, 5000K	4000+, 5000K	5000+, 5000K	6000+, 5000K	8000+, 5000K	10000+, 5000K
Energy Storage Packs: Li-Poly Battery	200WH	260WH	290WH	330WH	390WH	590WH
Mono-crystalline Tempered Glass Panel	40W	50W	60W	70W	80W	80W
Light Size (L x W x H)	35"x13"x1.6"	42"x13"x1.6"	50"x13"x1.6"	59"x13"x1.6"	80"x13"x1.6"	80"x13"x1.6"
Light Fixture Weight (lbs)	33	39	48	56	56	56
Light Pole High (Recommended with Feet)	13'-20'	15'-25'	15'-27'	20'-30'	20'-33'	20'-38'
Mounting Adaptor Diameter	2-1/2"			3-1/2"		
Aux Solar Panel/DC Adapter (option)			17-24VDC<5A			
Minimum Charging Time with Max Sunlight			5-8 Hours			
Operation Temp.: - 4°F to +125°F, IP65			Outdoor Application			
Comply with FCC Part 15 Class B and ICES-003:2004			Yes			

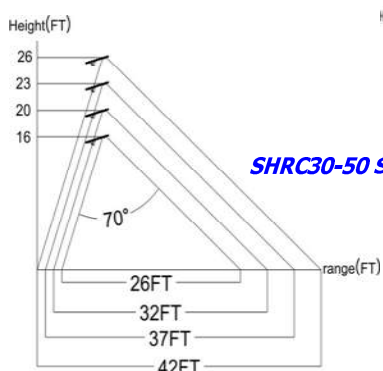

Set High vs Lighting Coverage

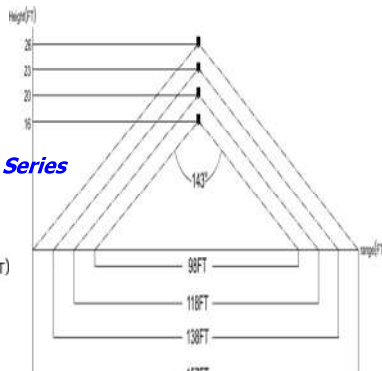

Set High vs Sensing Coverage

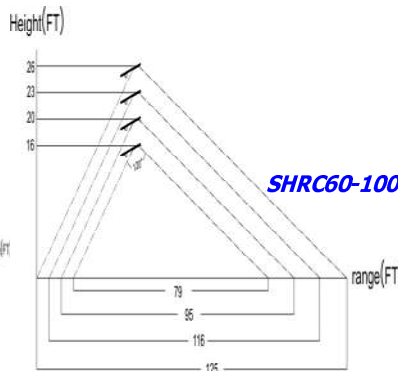

Set High vs Lighting Coverage

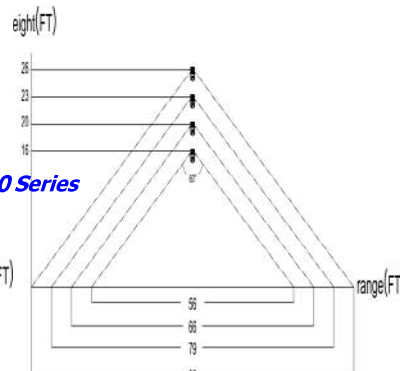

Set High vs Sensing Coverage

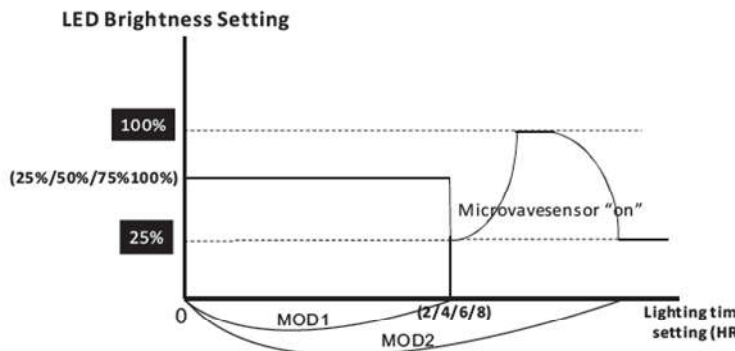
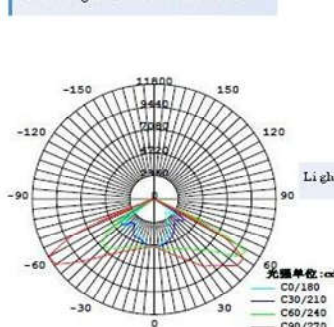
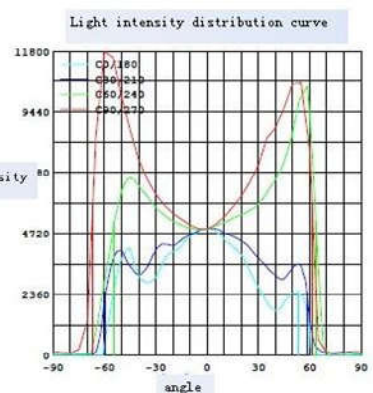

Fig-4 IPM Illumination Profile

Polar light distribution curve



Coordinate light intensity distribution curve



EE Systems Group Inc.

(Patented Technology)

12346 Valley Blvd, Suite A, El Monte, CA 91732 USA

Phone Number: 1-877-579-3889 info@eesgi.com www.eleding.com

Rev: 12092019