

Assembly Instructions





ASSEMBLY TIPS:

1. Remove hardware from plastic bag and sort by size.
2. Please check to see that all hardware and parts are present prior to assembly.
3. Please follow attached instructions in the same sequence as numbered to assure fast & easy assembly.



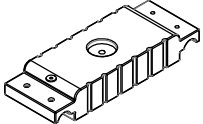
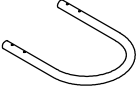
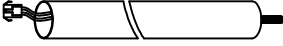

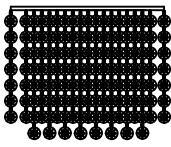
Warning !

1. Don't attempt to repair or modify parts that are broken or defective. Please contact the store immediately.
2. This product is for home use only and not intended for commercial establishment.



PARTS IDENTIFICATION:

DESCRIPTION	FIGURE	QTY
A Clump weight		1PC
B U Tube		1PC
C MAIN POST		1PC
D ARMS		1PC
E SHADE		3PCS
F SOCKET RING		3PCS

HARDWARE PACKAGE

NO	DESCRIPTION	FIGURE	QTY
1	Cross head screw		4PCS
2	Washer		4PCS
3	Nut with cap		4PCS
7	Wrench		1PC

PRE-INSTALLED HARDWARE

4	Silver NUT		1PC
5	Spring Washer		1PC
6	Flat Washer		1PC
8	Tapping Screw		1PC
9	Hollow Screw		1PC

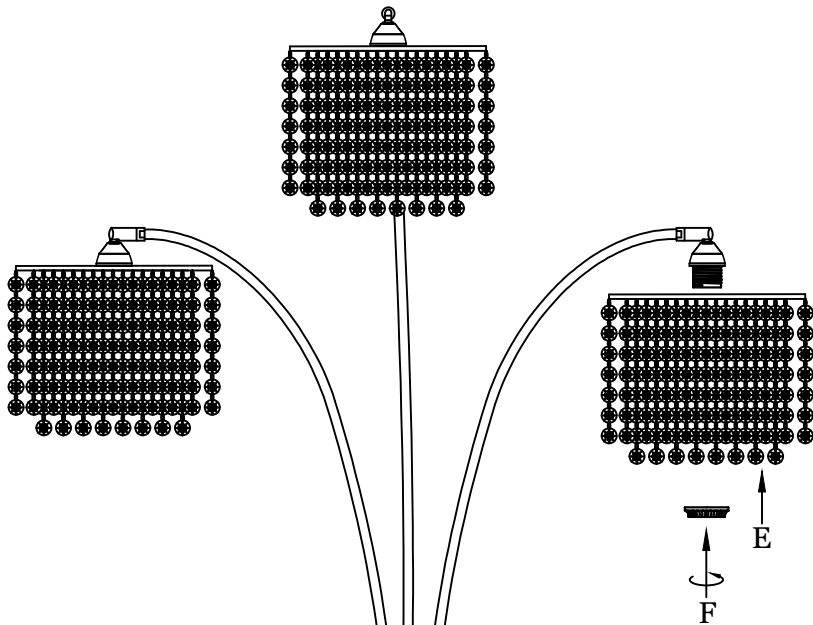

The mounting steps of the BASE G are as follows:

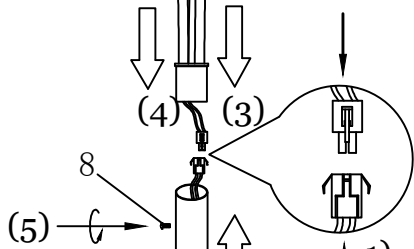
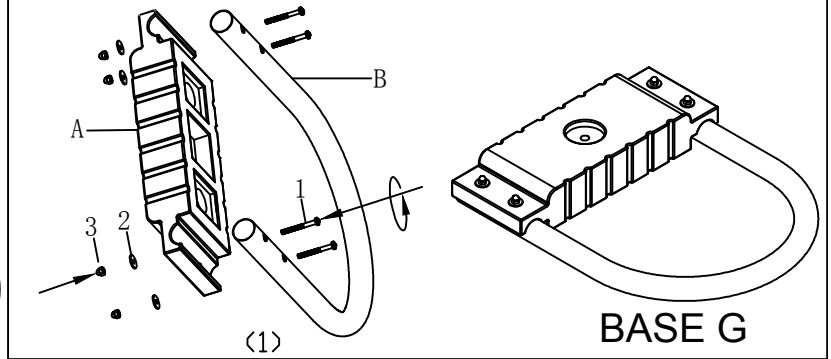

- 1) Align 4 small holes of CLUMP WEIGHT (A) with 4 holes of U TUBE (B) and tighten with CROSS HEAD SCREWS (1), WASHER (2), and CAP NUTS (3) packed in the plastic bag to assemble BASE G.
- 2) Unscrew the pre-installed SILVER NUT (4), SPRING WASHER (5), and FLAT WASHER (6) from MAIN POST (C) slightly adjust the pre-installed HOLLOW SCREW (9) and insert MAIN POST (C) into BASE G, then tighten with FLAT WASHER (6), SPRING WASHER (5) and SILVER NUT (4) with WRENCH (7).
- 3) Unscrew the pre -installed TAPPING SCREW (8) from ARMS (D), connect the plastic sockets, then put ARMS (D) into MAIN POST (C) and tighten by inserting TAPPING SCREW (8) into the hole on the MAIN POST (C).
- 4) Remove pre-installed SOCKET RINGS (F), assemble SHADES (E) to sockets ,and then tighten with SOCKET RINGS (F).
- 5) Install supplement light bulbs into sockets.

