

# Installation Instructions

# Air Conditioner

? Questions? Call 800.GE.CARES (800.432.2737) or Visit our Website at: GEAppliances.com



## BEFORE YOU BEGIN

Read these instructions completely and carefully.

- **IMPORTANT** – Save these instructions for local inspector's use.
- **IMPORTANT** – Observe all governing codes and ordinances.
- **Note to Installer** – Be sure to leave these instructions with the Consumer.
- **Note to Consumer** – Keep these instructions for future reference.
- **Skill level** – Installation of this appliance requires basic mechanical skills.
- **Completion time** – Approximately 1 hour
- We recommend that two people install this product.
- Proper installation is the responsibility of the installer.
- Product failure due to improper installation is not covered under the Warranty.

## Air conditioner break-in period

NOTE – As with any mechanical device with moving parts, this unit will have a wear-in period. AFTER INSTALLATION, this unit should be operated for 48 hours to achieve optimum efficiency.



## ELECTRICAL REQUIREMENTS

### WARNING

**Risk of electric shock. Can cause injury or death. This appliance must be properly grounded. Where a 2-prong wall outlet is encountered, it is your responsibility and obligation to have it replaced with a properly grounded 3-prong outlet.**



Some models require a 115/120-volt a.c., 60-Hz grounded outlet protected with a 15-amp time delay fuse or circuit breaker.

The 3-prong grounding plug minimizes the possibility of electric shock hazard. If the wall outlet you plan to use is only a 2-prong outlet, it is your responsibility to have it replaced with a properly grounded 3-prong wall outlet.

Do not, under any circumstances, cut or remove the third (ground) prong from the power cord.

Do not change the plug on the power cord of this air conditioner.

Aluminum house wiring may present special problems—consult a qualified electrician.



Some models require 230/208-volt a.c., protected with a time delay fuse or circuit breaker. These models should be installed on their own single branch circuit for best performance and to prevent overloading house or apartment wiring circuits, which could cause a possible fire hazard from overheating wires.



## IMPORTANT!

GE strongly recommends the removal of the old wall case and the installation of a new GE Wall Case. If you DO NOT use a GE Wall Case, you run the risk of poor performance or product failure. This is not covered under the terms of the GE warranty.

# Installation Instructions

Read these instructions completely and carefully.

Power cord may include a current interrupter device. A test and reset button is provided on the plug case. The device should be tested on a periodic basis by first pressing the **TEST** button and then the **RESET** button.

If the **TEST** button does not trip or if the **RESET** button will not stay engaged, discontinue use of the air conditioner and contact a qualified service technician.

## TOOLS YOU MAY NEED



Phillips-head screwdriver

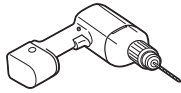

Drill

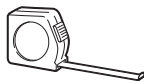

Ruler or Tape Measure

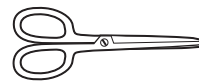

Scissors or knife



Hand or Saber Saw

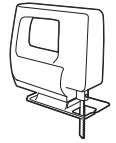

Adjustable Wrench



Pencil



Level

## GE KIT NUMBERS

USE GE KIT NUMBER:	FOR:	DESCRIPTION:
<b>RAB46A ,46, 47A, 47, 48A, 48B &amp; 48</b>	Use these kits for all GE models and other brands not listed	Standard wall case for "J" model chassis. RAG13 stamped aluminum exterior grille included. Remove the existing case and replace.
<b>RAK65A1</b>	All GE Models	Kit for window installation.
<b>RAK690</b>	RAB36, 37, 38, 46, 47 or 48 (J-Chassis)	If you attach a custom architectural outdoor grille, use this kit to ensure proper airflow.
<b>RAG13</b>	RAB36, 37, 38, 46, 47 or 48 (J-Chassis)	Standard aluminum exterior grille (included with RAB46, 47, 48, RAB46A, 47A, 48A, and 48B wall cases).
<b>RAG14E</b>	RAB36, 37, 38, 46, 47 or 48 (J-Chassis)	Architectural louvered exterior grille.

## ADA Compliance

<b>Operation by Remote Control</b>	A Remote Control device is shipped with GE Built-In Air Conditioners. When operated by Remote Control GE Built-in ACs meet all federal ADA compliance requirements.
<b>Operation at Control Panel</b>	GE Built In Air Conditioners intended to be operated at the control panel meet federal ADA compliance requirements when installed so that the controls are more than 15" from ground and less than 48" from the ground.
<b>Operation by Thermostat</b>	GE Air Conditioners intended to be operated via a wall thermostat meet federal ADA compliance requirements when used in conjunction with an ADA compliant wall thermostat mounted more than 15" and less than 48" from the ground.

# Installation Instructions

## INSTALLING A J-MODEL IN AN EXISTING WALL CASE

Read these instructions completely and carefully.

- 1 REMOVE ALL SHIPPING MATERIAL (IF PRESENT) INSIDE AIR CONDITIONER NEXT TO COMPRESSOR**

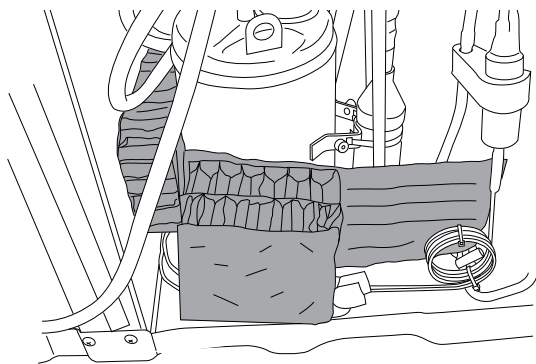

- 3 CAREFULLY SLIDE AIR CONDITIONER INTO CASE**

Make sure that the tubing on the unit does not touch the wall case and that the case installation is secure.

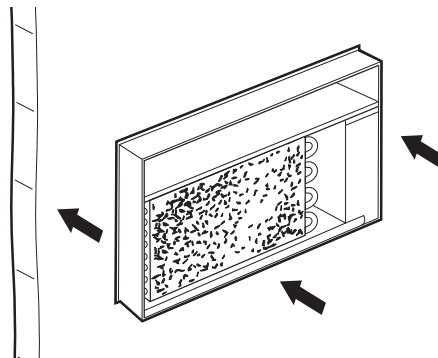

- 2 REMOVE THE FILTER AND FRONT GRILLE**

Remove the two screws behind the filter then remove the front grille.

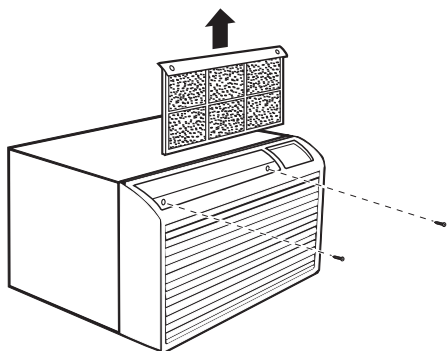

- 4 REINSTALL LOCKING PLATE WITH TAB BEHIND WALL CASE FLANGE. TIGHTEN SCREW**

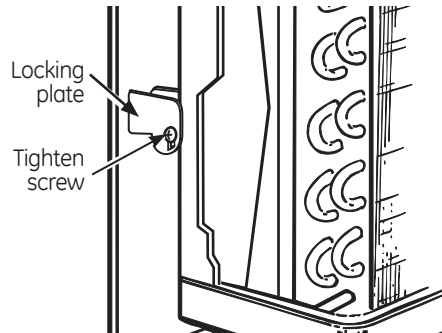

- 5 ATTACH FRONT GRILLE**

An opening for the power cord is on the bottom of the front grille.

